



All-new Mokka

Owner's Manual

Contents

Emergency numbers		
For emergency service call the Vauxhall Incident Manager		0800 55 33 88 (Free Linkline)*
Vauxhall Assistance General Enquiries		0845 7565 565
You will need to provide:	Vehicle registration number	Model and colour of your Vauxhall
	Contact telephone number	Details of your precise location

* Calls may be chargeable from mobile phones

Introduction	2
Keys, doors and windows	6
Seats, restraints	26
Storage	46
Instruments and controls	53
Lighting	84
Infotainment system	93
Climate control	151
Driving and operating	162
Vehicle care	245
Service and maintenance	280
Technical data	285
Customer information	292
Index	302

Introduction

Fuel	Designation	<input type="text"/>		
Engine oil	Grade	<input type="text"/>		
	Viscosity	<input type="text"/>		
Tyre pressure	Tyre size		Front	Rear
	Summer tyres	<input type="text"/>	<input type="text"/>	<input type="text"/>
	Winter tyres	<input type="text"/>	<input type="text"/>	<input type="text"/>
Weights	Gross vehicle weight rating	<input type="text"/>		
	- Kerb weight, basic model	<input type="text"/>		
	= Loading	<input type="text"/>		

Vehicle specific data

Please enter your vehicle's data on the previous page to keep it easily accessible.

Please refer to the sections "Service and maintenance", "Technical data", the vehicle's identification plate and national registration documents.

Introduction

Your vehicle is a designed combination of advanced technology, safety, environmental friendliness and economy.

This Owner's Manual provides you with all the necessary information to enable you to drive your vehicle safely and efficiently.

Some functions are only operational when ignition is switched on, when combustion engine is running or when electric engine is ready.

Make sure your passengers are aware of the possible risk of accident and injury which may result from improper use of the vehicle.

You must always comply with the specific laws and regulations of the country that you are in. These laws may differ from the information in this Owner's Manual.

Disregarding the description given in this manual may affect your warranty.

When this Owner's Manual refers to a workshop visit, we recommend your Vauxhall Authorised Repairer.

All Vauxhall Authorised Repairers provide first-class service at reasonable prices. Experienced mechanics trained by Vauxhall work according to specific Vauxhall instructions.

The customer literature pack should always be kept ready to hand in the vehicle.

Using this manual

- This manual describes all options and features available for this model. **Certain descriptions, including those for display and menu functions, may not apply to your vehicle due to model**

variant, country specifications, special equipment or accessories.

- The table of contents at the beginning of this manual and within each section shows where the information is located.
- The index will enable you to search for specific information.
- This Owner's Manual depicts left-hand drive vehicles. Operation is similar for right-hand drive vehicles.
- The Owner's Manual uses the engine identifier code. The corresponding sales designation and engineering code can be found in the section "Technical data".
- Directional data, e.g. left or right, or front or back, always relate to the direction of travel.
- Displays may not support your specific language.
- Display messages and interior labelling are written in **bold** letters.

Propulsion types

Internal combustion engine (ICE) vehicle

ICE vehicles are propelled by an internal combustion engine - diesel or petrol - only.

Battery electric vehicle (BEV)

BEVs are propelled by an electric engine only.

The high voltage battery is charged using a charging cable and additionally by engine braking.

Danger, Warnings and Cautions

Danger

Text marked ** Danger** provides information on risk of fatal injury. Disregarding this information may endanger life.

Warning

Text marked ** Warning** provides information on risk of accident or injury. Disregarding this information may lead to injury.

Caution

Text marked **Caution** provides information on possible damage to the vehicle. Disregarding this information may lead to vehicle damage.

Symbols

Page references are indicated with ⇨. ⇨ means "see page".

Page references and index entries refer to the indented headings given in the section table of content.

Thank you for choosing a Vauxhall.

We wish you many hours of pleasurable driving.

Your Vauxhall Team

Keys, doors and windows

Keys, locks	6
Keys	6
Radio remote control	7
Electronic key system	8
Central locking system	10
Automatic locking	14
Child locks	15
Doors	16
Load compartment	16
Vehicle security	17
Anti-theft locking system	17
Anti-theft alarm system	18
Immobiliser	19
Exterior mirrors	20
Convex shape	20
Electric adjustment	20
Folding mirrors	20
Heated mirrors	21
Interior mirrors	21
Manual anti-dazzle	22
Automatic anti-dazzle	22
Windows	22
Windscreen	22

Power windows	23
Heated rear window	24
Sun visors	24
Roller blinds	25

Keys, locks

Keys

Caution

Do not attach heavy or bulky items to the ignition key.

⚠ Danger

Never remove the key from ignition switch during driving as this will cause steering wheel lock.

Replacement keys

The key number is specified on a detachable tag.

The key number must be quoted when ordering replacement keys as it is a component of the immobiliser system.

Locks ⇨ 276.

Central locking ⇨ 10.

Starting the engine ⇨ 166.

Radio remote control ⇨ 7.

Electronic key ⇨ 8.

The code number of the adapter for the locking wheel nuts is specified on a card. It must be quoted when ordering a replacement adapter.

Wheel changing ⇨ 268.

Key with foldaway key section



Press button to extend. To fold the key, first press the button.



Lock cylinders

Designed to free-wheel if they are forcefully rotated without the correct key or if the correct key is not fully inserted. To reset, insert the correct

key only half way and turn cylinder until its slot is vertical, remove key then re-insert it. If the cylinder still free-wheels, insert the key only half way and turn the key through 180° and repeat operation.

Radio remote control



-  : unlocks the vehicle
-  : locks the vehicle
-  : long press unlocks and opens the tailgate

Enables operation of the following functions via the use of the remote control buttons:

- central locking system ⇨ 10
- anti-theft locking system ⇨ 17
- anti-theft alarm system ⇨ 18
- tailgate unlocking
- power windows ⇨ 23
- mirrors folding ⇨ 20
- vehicle locator lighting ⇨ 92

The remote control has a range of up to 50 m, but may also be much less due to external influences. The hazard warning flashers confirm operation.

Handle with care, protect from moisture and high temperatures and avoid unnecessary operation.

Replacing battery in radio remote control

Replace the battery as soon as the system no longer operates properly or the range is reduced.

In the event of a discharged battery,  illuminates and a warning message is displayed in the Driver Information Centre.

Driver Information Centre ⇨ 80.



Batteries do not belong in household waste. They must be disposed of at an appropriate recycling collection point.

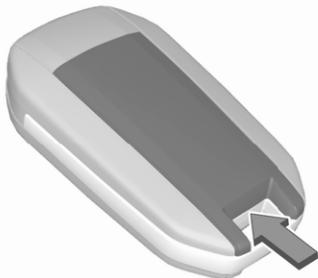

1. Remove the back cover from the remote control.
2. Extract the flat battery from its location.
3. Replace battery with a battery of the same type. Pay attention to the installation position.
4. Clip the back cover in place.

Fault

If the central locking system cannot be operated with the radio remote control, the cause may be one of the following:

- Fault in radio remote control.
- The battery voltage is too low.
- Overload of the central locking system by operating at frequent intervals, the power supply is interrupted for a short time.
- Interference from higher-power radio waves from other sources.

Manual unlocking ⇨ 10.

Electronic key system

Warning

The electronic key can affect a pacemaker.

Keep the electronic key away from the breast.



Enables a keyless operation of the following functions:

- central locking system ⇨ 10
- ignition switching on and starting the engine ⇨ 166

The electronic key simply needs to be on the driver's person.

For reasons of security, the electronic key may be equipped with a motion sensor. If so, starting of the vehicle is not possible when the electronic key has not been moved for a certain time. When trying to start the vehicle, a corresponding message appears in the Driver Information Centre. Move the electronic key and try to start the vehicle again.

Additionally, the electronic key includes the functionality of the radio remote control ↗ 7.

Handle with care, protect from moisture and high temperatures and avoid unnecessary operation.

Replacing battery in electronic key

Replace the battery as soon as the system no longer operates properly or the range is reduced.

In the event of a discharged battery,  illuminates and a warning message is displayed in the Driver Information Centre.

Driver Information Centre ↗ 80.



Batteries do not belong in household waste. They must be disposed of at an appropriate recycling collection point.



1. Remove the back cover.
2. Extract the flat battery from its location.
3. Replace battery with a battery of the same type. Insert the battery by pushing it against the contact

located in the corner and then pressing it down. Pay attention to the installation position.

4. Clip the back cover in place.

Fault

If the central locking cannot be operated or the engine cannot be started, the cause may be one of the following:

- Fault in electronic key.
- Electronic key is out of reception range.
- The battery voltage is too low.
- Overload of the central locking system by operating at frequent intervals, the power supply is interrupted for a short time.
- Interference from higher-power radio waves from other sources.
- Interference from electronic devices such as smartphones or laptops.

To rectify the cause of the fault, change the position of the electronic key.

Manual unlocking ↗ 10.

Central locking system

Unlocks and locks doors, load compartment and fuel filler flap.

A pull on an interior door handle opens the respective door.

Notice

In the event of an accident in which airbags or belt pretensioners are deployed, the vehicle is automatically unlocked.

Remote control operation

Unlocking





Press .

Notice

A short time after unlocking the vehicle with the remote control, the doors are locked automatically if no door has been opened.

Unlocking mode can be set in the vehicle personalisation menu in the Info Display. Following settings are selectable:

- All doors, load compartment and fuel filler flap will be unlocked by pressing  once.
- Only the driver's door and fuel filler flap will be unlocked by pressing  once. To additionally unlock all doors and the load compartment, press  twice.

Select the relevant setting in the Vehicle personalisation.

Vehicle personalisation  81.

Locking

Close doors, load compartment and fuel filler flap.



Press .

If the vehicle is not closed properly, the central locking system will not work.



Operation of the central locking system is confirmed by the hazard warning flashers.

Load compartment



Press and hold  to unlock.

Unlocking settings for the load compartment can be set in the vehicle personalisation:

- Only the load compartment will be unlocked by pressing  once.
- All doors, load compartment and fuel filler flap will be unlocked by pressing  once.

Depending on the chosen setting in the vehicle personalisation, the load compartment can be locked:

- by simply closing the opened tailgate.
- by pressing  once on the remote control with the tailgate closed.

Select the relevant setting in the vehicle personalisation.

Vehicle personalisation ⇨ 81.

Unlocking the tailgate ⇨ 16.

Confirmation

Operation of the central locking system is confirmed by the hazard warning flashers and an audible chime.

Electronic key system operation

The electronic key must be outside the vehicle, within a range of approx. 1 m of the relevant door side.

This system allows automatic vehicle locking and unlocking simply by detection of the electronic key. The electronic key must be outside the vehicle.

Notice

If the vehicle is not closed properly or the electronic key remains in the vehicle, locking will not be permitted. If the vehicle is equipped with an anti-theft alarm system, a warning chime sounds after a few seconds.

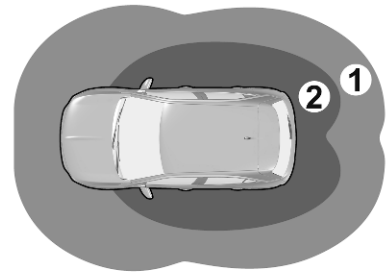

Notice

The electronic key may not operate if placed close to electronic devices such as mobile phones or laptop computers.



- Zone 1: automatic locking on leaving the vehicle
- Zone 2: automatic unlocking on approaching the vehicle



Notice



If the electronic key remains for more than 15 minutes in zone 1, automatic unlocking is deactivated. Unlock the vehicle by pressing  or  on the remote control or touch the sensor of the driver's door handle to unlock the vehicle. Automatic locking and unlocking is activated again.

Notice

A short time after automatic unlocking, the vehicle is relocked if no door has been opened.

Notice

If the ignition is switched off for more than 9 days or the vehicle battery has no sufficient charging, the automatic function is disabled. Press  or  on the remote control or touch the sensor of the driver's door handle to unlock the vehicle.

In the event that the ignition is switched off for more than 21 days, the only way to unlock the vehicle is by pressing  or  on the remote control.

Unlocking / locking

Unlocking / locking mode can be set in the vehicle personalisation menu in the Info Display. Following settings are selectable:

- Only the driver's door and fuel filler flap will be unlocked / locked.
- All doors, load compartment and fuel filler flap will be unlocked / locked.
- Only the load compartment will be unlocked / locked.

Vehicle personalisation ⇨ 81.

Load compartment ⇨ 16.

Operation with buttons on the electronic key

The central locking system can also be operated with the buttons on the electronic key.

Press  or  to unlock.

Press  to lock.

Remote control operation ⇨ 10.

Driver's door handle

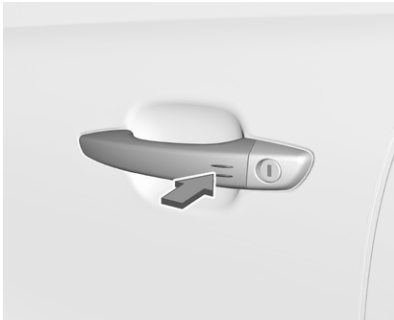

The central locking system can also be operated by touching on the sensor of the driver's door handle.

Touch the sensor of the drivers's door handle to unlock or to lock.

Confirmation

Operation of central locking system is confirmed by the hazard warning flashers.

Central locking button

Locks or unlocks all doors, the load compartment and fuel filler flap from inside the passenger compartment.

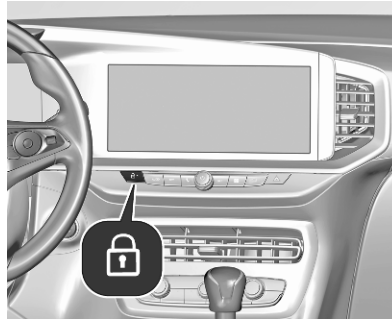

Press  to lock. The LED in the button illuminates.

Press  again to unlock. The LED in the button extinguishes.

Operation with the key in case of a central locking system fault

In case of a fault, e.g. vehicle battery or remote control / electronic key battery is discharged, the front door can be locked or unlocked with the mechanical key.

Manual unlocking



Electronic key: push the latch to extract the integral key.

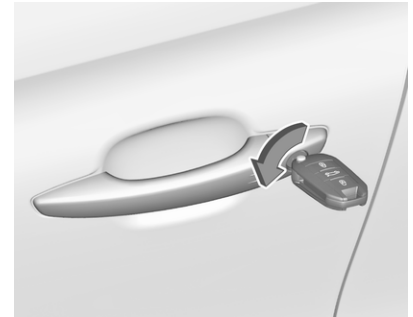

Manually unlock the left front door by inserting and turning the key in the lock cylinder.

The other doors can be opened by pulling the interior handle. The load compartment and fuel filler flap will possibly not be unlocked.

By switching on the ignition, the anti-theft locking system is deactivated.

Manual locking

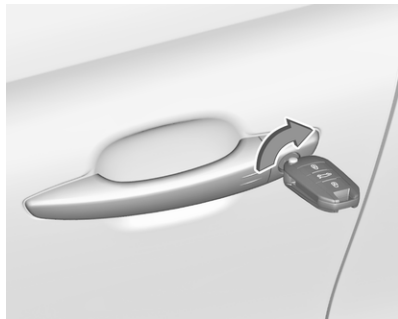

Manually lock the front door by inserting and turning the key in the lock cylinder.



To lock the other doors, open the rear doors. Ensure that child lock is deactivated.

Insert key carefully and turn it to the inner side of the doors.

Then, remove key.

Close the doors.

The fuel filler flap and tailgate are possibly not locked.

Automatic locking

Automatic locking after driving off

This system allows automatic locking of the doors and tailgate as soon as the speed of the vehicle exceeds a certain speed.

If one of the doors or the tailgate is open, the automatic central locking does not take place. This is signalled by the sound of the locks rebounding, accompanied by illumination of  in the Driver Information Centre, an audible signal and the display of an alert message.



This function can be activated or deactivated at any time. With the ignition on, press  until an audible signal starts and a corresponding message is displayed.

The state of the system stays in memory when switching off the ignition.

Automatic relock after unlocking

This feature automatically relocks the vehicle a short time after unlocking with the remote control or electronic key, provided vehicle has not been opened.

Child locks

Warning

Use the child locks whenever children are occupying the rear seats.

Mechanical child locks

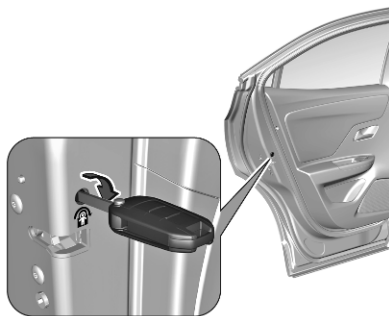

Turn the red child lock in the rear door inwards to the horizontal position by using a key. The door cannot be opened from the inside.

To deactivate, turn the child lock to the vertical position.

Electric child locks

Remotely operated system to prevent opening of the rear doors via the interior door handles and the use of the rear power windows.

Two versions are available.

Switching on



Press . The LED in the button is illuminated, accompanied by a confirmation message. This LED remains illuminated until the child lock is switched off again.

Or



Press .

Switching off

Press  again. The LED in the button is extinguished, accompanied by a confirmation message.

Or

Press  again.

Power windows ⇨ 23.

Doors

Load compartment

Tailgate

Opening

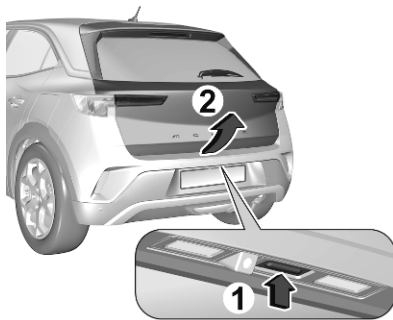

1. Press the tailgate button or press long  on the radio remote control.
2. Open the tailgate.

Closing



Use the interior handle.

Do not push the tailgate button whilst closing as this will open the tailgate again.

Central locking system ⇨ 10.

General hints for operating tailgate

 **Danger**

Do not drive with the tailgate open or ajar, e.g. when transporting bulky objects, since toxic exhaust

gases, which cannot be seen or smelled, could enter the vehicle. This can cause unconsciousness and even death.

Caution

Before opening the tailgate, check overhead obstructions, e.g. a garage door, to avoid damage to the tailgate. Always check the moving area above and behind the tailgate.

Notice

The installation of certain heavy accessories onto the tailgate may affect its ability to remain open.

Notice

At low outside temperatures the tailgate may not open fully by itself. In this case lift the tailgate manually to its normal end position.

Vehicle security

Anti-theft locking system

⚠ Warning

Do not use the system if there are people in the vehicle! The doors cannot be unlocked from the inside.

The system deadlocks all the doors. All doors must be closed otherwise the system cannot be activated.

Unlocking the vehicle disables the mechanical anti-theft locking system. This is not possible with the central locking button.

Activating



Press  on the radio remote control or touch the sensor of the driver's door handle twice within 3 seconds.

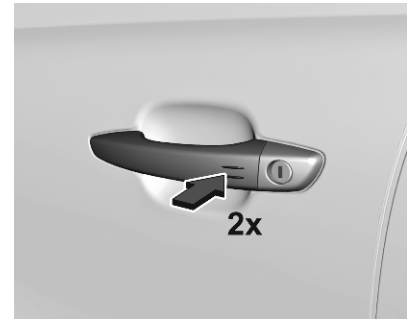

Anti-theft alarm system

The anti-theft alarm system is combined with the central locking system.

It monitors:

- doors, tailgate, bonnet
- passenger compartment including adjoining load compartment
- vehicle inclination, e.g. if it is raised
- ignition

Activation

All doors, the load compartment and the engine compartment must be closed.

The electronic key must not remain in the vehicle.

The system is self-activated 45 seconds after locking the vehicle.

If a door, the tailgate or the bonnet is not properly closed, the vehicle is not locked. However, the anti-theft alarm is self-activated after 45 seconds.

Notice

The automatic vehicle locking function does not activate the anti-theft alarm system.

To activate the anti-theft alarm system, lock the vehicle by using the radio remote control or by touching the sensor on the driver's door handle.

Central locking system ↪ 10.



Notice

Changes to the vehicle interior such as the use of seat covers and open windows, could impair the function of passenger compartment monitoring.

Activation without monitoring of passenger compartment and vehicle inclination



Switch off the monitoring of passenger compartment and vehicle inclination when animals are being left in the vehicle, because of high volume ultrasonic signals or movements triggering the alarm. Also, switch off when the vehicle is on a ferry or train.

1. Close tailgate, bonnet, windows.
2. Switch off ignition and press  OFF within 10 seconds until the LED in the button  illuminates.

3. Leave the vehicle and close the doors.
4. Activate the anti-theft alarm system.

Indication

LED in the  button flashes if the anti-theft alarm system is activated. The hazard warning lights illuminates for a few seconds.

Deactivation

Unlocking the vehicle deactivates the anti-theft alarm system.

The system is not deactivated by unlocking the front door with the key or with the central locking button in the passenger compartment.

Alarm

When triggered, the alarm siren sounds and the hazard warning lights flash simultaneously. The number and duration of alarm signals are stipulated by legislation.

The anti-theft alarm can be deactivated by pressing  or switching on the ignition.

A triggered alarm, which has not been interrupted by the driver, will be indicated by the LED in the button . The LED will flash quickly the next time the vehicle is unlocked.

If the vehicle battery has been reconnected (e.g. after maintenance work), wait for 10 minutes to restart the engine.

Fault

If the LED in the button  illuminates permanently when switching on the ignition, seek the assistance of a workshop.

Locking the vehicle without activation of the anti-theft alarm

Lock the vehicle by locking the front door with the key.

Immobiliser

The system is part of the ignition switch and checks whether the vehicle is allowed to be started with the key being used.

The immobiliser is activated automatically.

Notice

Radio Frequency Identification (RFID) tags may cause interference with the key. Do not have it placed near the key when starting the vehicle.

Notice

The immobiliser does not lock the doors. Always lock the vehicle after leaving it  10.

Switch on the anti-theft alarm system  18.

Emergency operation of electronic key  164.

Exterior mirrors

Convex shape

The shape of the mirror makes objects appear smaller, which will affect the ability to estimate distances.

Side blind spot alert ⇨ 216.

Electric adjustment

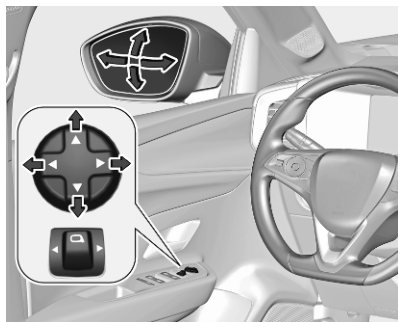

Select the relevant exterior mirror by pushing  to the left or right.

Then swivel the control to adjust the mirror.

Folding mirrors





For pedestrian safety, the exterior mirrors will swing out of their normal mounting position if they are struck with sufficient force. Reposition the mirror by applying slight pressure to the mirror housing.

Manual electric folding



Move  to the centre position.

Pull  rearwards. Both exterior mirrors are folded.

Pull  rearwards again. Both exterior mirrors return to their original position.

If an electrically folded mirror is manually unfolded, pulling  rearwards will only unfold the other mirror electrically.

Automatic electric folding

When the vehicle is unlocked, the mirrors swing to their normal mounting position. When the vehicle is locked, the mirrors are folded down.

To enable or disable automatic folding of the exterior mirrors, consult a workshop.

Heated mirrors



Operated by pressing .

The heating switches off automatically after a certain time depending on the outside temperature.

Heated rear window  24.

Interior mirrors

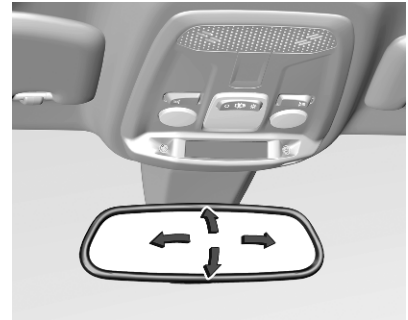

To adjust the mirror, move the mirror housing in the desired direction.

Manual anti-dazzle



To reduce dazzle, adjust the lever on the underside of the mirror housing.

Automatic anti-dazzle



Dazzle from following vehicles is automatically reduced, when driving in the dark.

Windows

Windscreen

Windscreen stickers

Do not attach stickers such as toll road stickers or similar on the windscreen in the area of the interior mirror. Otherwise the detection zone of the sensor and the view area of the camera in the mirror housing could be restricted.

Windscreen replacement

Caution
If the vehicle has a front-looking camera sensor for the driver assistance systems, it is very important that any windscreen replacement is performed accurately according to Vauxhall specifications. Otherwise, these systems may not work properly and there is a risk of unexpected behaviour and / or messages from these systems.

Power windows

⚠ Warning

Take care when operating the power windows. Risk of injury, particularly to children.

If there are children on the rear seats, switch on the child safety system for the power windows.

Keep a close watch on the windows when closing them.

Ensure that nothing becomes trapped in them as they move.



Operate the switch for the respective window by pushing to open or pulling to close.

Pushing or pulling gently to the first detent: window moves up or down as long as the switch is operated.



Pushing or pulling firmly to the second detent then releasing: window moves up or down automatically with safety function enabled. To stop movement, operate the switch once more in the same direction.

Safety function

If the window glass encounters resistance of the window during automatic closing, it is immediately stopped and opened again.

Child safety system for rear windows



Press  to deactivate rear door power windows; the LED illuminates. To activate, press  again.

Depending on version, additionally operation of electric child locks  15.

Closing windows from outside

The windows can be closed remotely from outside the vehicle.

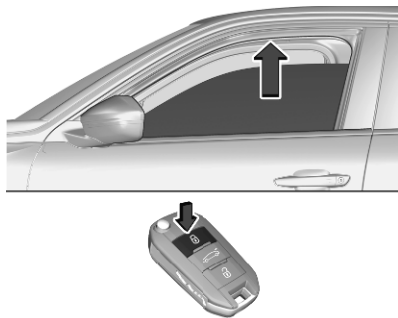

Press and hold  to close windows.

If the windows are fully closed, the hazard warning lights will flash twice.

Overload

If the windows are repeatedly operated within short intervals, the window operation is disabled for some time.

Initialising the power windows

Activate the window electronics as follows:

1. Close doors.
2. Switch on ignition.

3. Open the window completely by using the switch.
4. Pull the switch repeatedly until the window is completely closed and keep pushing for additional 1 second. Note that the window closes only a few centimetres after each pull of the switch.
5. Repeat for each window.

Heated rear window

Operated by pressing  together with heated exterior mirrors.

Heating is switched off automatically after a short time.

Depending on climate control system,  is located at a different position.



Heated mirrors ⇨ 21.

Sun visors

The sun visors can be folded down or swivelled to the side to prevent dazzling.

If the sun visors have integral mirrors, the mirror covers should be closed when driving.

A ticket holder is located on the backside of the sun visor.

Roller blinds

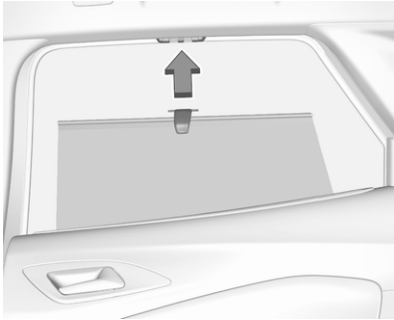

To reduce sunlight at the rear seats, pull the blind upwards using the grip and engage it at the top of the door frame.

Seats, restraints

Head restraints	26
Front seats	27
Seat position	27
Manual seat adjustment	28
Power seat adjustment	29
Armrest	29
Heating	30
Massage	30
Seat belts	30
Three-point seat belt	31
Airbag system	33
Front airbag system	36
Side airbag system	36
Curtain airbag system	37
Airbag deactivation	38
Child restraints	39
Child restraint systems	39
Child restraint installation locations	43

Head restraints

Position

⚠ Warning

Only drive with the head restraint set to the proper position.

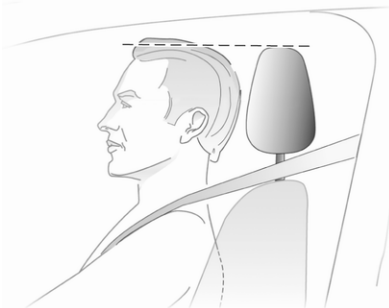

The upper edge of the head restraint should be at upper head level. If this is not possible for extremely tall people, set to highest position, and set to lowest position for small people.

Height adjustment

Head restraints on front seats

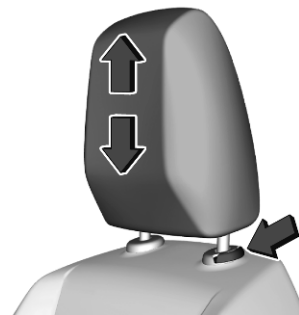

Pull the head restraint upwards or press the catch to release and push the head restraint downwards.

Head restraints on rear seats

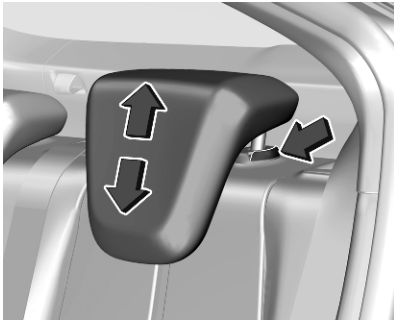

Pull the head restraint upwards or press the catch to release and push the head restraint downwards.

Removal

Press catch, pull the respective head restraint upwards and remove.

Front seats

Seat position

⚠ Warning

Only drive with the seat correctly adjusted.

⚠ Warning

Never adjust seats while driving as they could move uncontrollably.

⚠ Danger

Do not sit closer than 25 cm to the steering wheel, to permit safe airbag deployment.

⚠ Warning

Never store any objects under the seats.



- Sit with buttocks as far back against the backrest as possible. Adjust the distance between the seat and the pedals so that legs are slightly angled when pressing the pedals. Slide the front passenger seat as far back as possible.
- Set seat height high enough to have a clear field of vision on all sides and of all display instruments. There should be at least one hand of clearance between head and the roof frame. Your thighs should rest lightly on the seat without pressing into it.

- Adjust the head restraint so that its upper edge is at upper head level.
- Sit with shoulders as far back against the backrest as possible. Set the backrest rake so that it is possible to easily reach the steering wheel with arms slightly bent. Maintain contact between shoulders and the backrest when turning the steering wheel. Do not angle the backrest too far back. We recommend a maximum rake of approx. 25°.
- Adjust seat and steering wheel in a way that the wrist rests on top of the steering wheel while the arm is fully extended and shoulders are on the backrest.
- Adjust the lumbar support so that it supports the natural shape of the spine.

Head restraint adjustment ⇨ 26.

Steering wheel adjustment ⇨ 57.

Manual seat adjustment

Drive only with engaged seats and backrests.

Longitudinal adjustment



Pull handle, slide seat, release handle. Try to move the seat back and forth to ensure that the seat is locked in place.

Backrest inclination



Turn handwheel. Do not lean on backrest when adjusting.

Seat height



Lever pumping motion

up : seat higher
down : seat lower

Power seat adjustment

⚠ Warning



Care must be taken when operating the power seats. There is a risk of injury, particularly for children. Objects could become trapped.

Keep a close watch on the seats when adjusting them. Vehicle passengers should be informed accordingly.

Lumbar support



Press  or .

 : more lumbar support
 : less lumbar support

Armrest

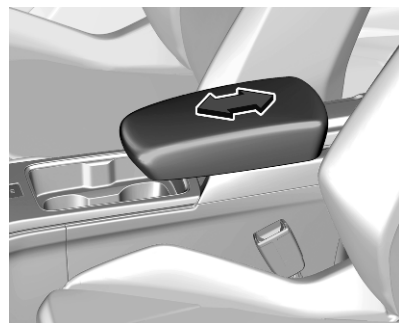

The armrest can be adjusted.
Storage compartment ⇨ 47.

Heating



Adjust heating to the desired setting by pressing  for the respective seat one or more times. The control indicator in the button indicates the setting.

The heating works only when the outside temperature is below 20 °C.

Prolonged use of the highest setting for people with sensitive skin is not recommended.

Stop-start system ⇨ 167.

Massage



Activate the back massage function by pressing . The LED in the button illuminates to indicate activation.

The massage function is activated for a period of 1 hour. During this time, massage is performed in six cycles with breaks in between.

Pressing  once more deactivates massage function. The LED goes off.

Stop-start system ⇨ 167.

Seat belts



The seat belts are locked during heavy acceleration or deceleration of the vehicle, holding the occupants in the seat position. Therefore the risk of injury is considerably reduced.

Warning

Fasten seat belt before each trip.

In the event of an accident, people not wearing seat belts endanger their fellow occupants and themselves.

Seat belts are designed to be used by only one person at a time.

Child restraint system ⇨ 39.

Periodically check all parts of the belt system for damage, soiling and proper functionality.

Have damaged components replaced. After an accident, have the seat belts and triggered belt pretensioners replaced by a workshop.

Notice

Make sure that the belts are not damaged by shoes or sharp-edged objects or are trapped. Prevent dirt from getting into the belt retractors.

Notice

Use the belt buckle intended for the respective seat belt when fastening in order to ensure proper functionality.

Seat belt reminder

Each seat is equipped with a seat belt reminder, indicated by a control indicator  for the respective seat in the roof console ⇨ 69.

Belt force limiters

Stress on the body is reduced by the gradual release of the belt during a collision.

Belt pretensioners

In the event of a head-on, rear-end or side-on collision of a certain severity, the front seat belts and the outer rear seat belts are tightened.

Warning

Incorrect handling (e.g. removal or fitting of belts) can trigger the belt pretensioners.

Deployment of the belt pretensioners is indicated by continuous illumination of control indicator  ⇨ 70.

Triggered belt pretensioners must be replaced by a workshop. Belt pretensioners can only be triggered once.

Notice

Do not affix or install accessories or other objects that may interfere with the operation of the belt

pretensioners. Do not make any modifications to belt pretensioner components as this will invalidate the operating permit of your vehicle.

Three-point seat belt

Fasten

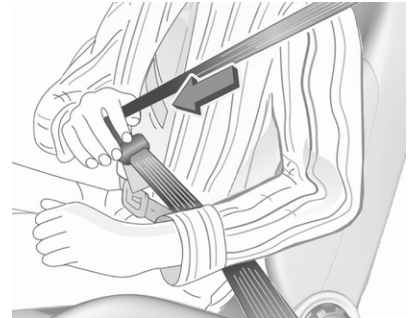

Withdraw the seat belt from the retractor, guide it untwisted across the body and insert the latch plate into the buckle. Make sure the seat belt lies across the shoulder and fits tightly to the body while driving.

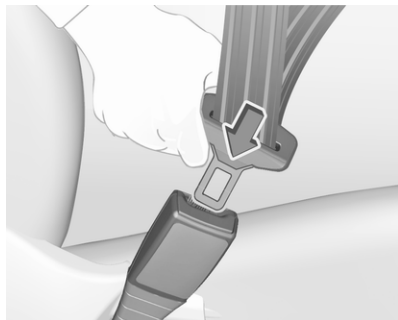

Loose or bulky clothing prevents the seat belt from fitting snugly. Do not place objects such as handbags or mobile phones between the seat belt and your body.

⚠ Warning

The seat belt must not rest against hard or fragile objects in the pockets of your clothing.

Seat belt reminder   69.

Unfasten

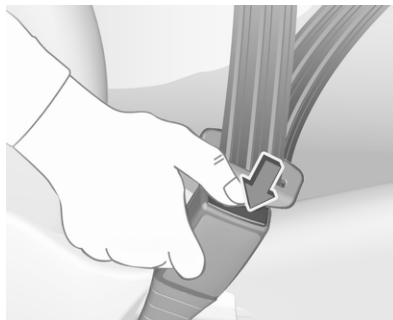

To release seat belt, press red button on seat belt buckle and guide the seat belt back.

Using seat belts while pregnant



⚠ Warning

The lap belt must be positioned as low as possible across the pelvis to prevent pressure on the abdomen.

Airbag system

The airbag system consists of a number of individual systems.

When triggered, the airbags inflate within milliseconds. They also deflate so quickly that it is often unnoticeable during the collision.

⚠ Warning

The airbag system deploys in an explosive manner, repairs must be performed by skilled personnel only.

⚠ Warning

Adding accessories that change the vehicle's frame, bumper system, height, front end or side sheet metal, may keep the airbag system from working properly. The operation of the airbag system can also be affected by changing any parts of the front seats, seat belts, airbag sensing and diagnostic module, steering wheel,

instrument panel, inner door seals including the speakers, any of the airbag modules, ceiling or pillar trim, front sensors, side impact sensors or airbag wiring.

⚠ Warning

Keep the area in which the airbag inflates clear of obstructions.



Notice

The airbag systems and belt pretensioner control electronics are located in the centre console area. Do not put any magnetic objects in this area.

Do not affix any objects onto the airbag covers and do not cover them with other materials. Have damaged covers replaced by a workshop.

Each airbag is triggered only once. Have deployed airbags replaced by a workshop. Furthermore, it may be necessary to have the steering wheel, the instrument panel, parts of the panelling, the door seals, handles and the seats replaced.

Do not make any modifications to the airbag system as this will invalidate the vehicle operating permit.

Control indicator  for airbag systems  70.

Child restraint systems on front passenger seat with airbag systems

Warning according to ECE R94.03:



EN: NEVER use a rearward-facing child restraint on a seat protected by an ACTIVE AIRBAG in front of it; DEATH or SERIOUS INJURY to the CHILD can occur.

DE: Nach hinten gerichtete Kindersitze NIEMALS auf einem Sitz verwenden, der durch einen davor befindlichen AKTIVEN AIRBAG geschützt ist, da dies den TOD oder SCHWERE VERLETZUNGEN DES KINDES zur Folge haben kann.

FR: NE JAMAIS utiliser un siège d'enfant orienté vers l'arrière sur un siège protégé par un COUSSIN GONFLABLE ACTIF placé devant lui, sous peine d'infliger des BLESSURES GRAVES, voire MORTELLES à l'ENFANT.

ES: NUNCA utilice un sistema de retención infantil orientado hacia atrás en un asiento protegido por un AIRBAG FRONTAL ACTIVO. Peligro de MUERTE o LESIONES GRAVES para el NIÑO.

RU: ЗАПРЕЩАЕТСЯ устанавливать детское удерживающее устройство лицом назад на сиденье автомобиля, оборудованном фронтальной подушкой безопасности, если ПОДУШКА НЕ ОТКЛЮЧЕНА! Это

может привести к СМЕРТИ или СЕРЬЕЗНЫМ ТРАВМАМ РЕБЕНКА.

NL: Gebruik NOOIT een achterwaarts gericht kinderzitje op een stoel met een ACTIEVE AIRBAG ervoor, om DODELIJK of ERNSTIG LETSEL van het KIND te voorkomen.

DA: Brug ALDRIG en bagudvendt autostol på et forsæde med AKTIV AIRBAG, BARNET kan komme i LIVSFARE eller komme ALVORLIGT TIL SKADE.

SV: Använd ALDRIG en bakåtvänd barnstol på ett säte som skyddas med en framförvarande AKTIV AIRBAG. DÖDSFALL eller ALLVARLIGA SKADOR kan drabba BARNET.

FI: ÄLÄ KOSKAAN sijoita taaksepäin suunnattua lasten turvaistuinta istuimelle, jonka edessä on AKTIIVINEN TURVATYYNYY, LAPSI VOI KUOLLA tai VAMMAUTUA VAKAVASTI.

NO: Bakovervendt barnesikringsutstyr må ALDRI brukes på et sete med AKTIV KOLLISJONSPUTE foran, da det kan

føre til at BARNET utsettes for LIVSFARE og fare for ALVORLIGE SKADER.

PT: NUNCA use um sistema de retenção para crianças voltado para trás num banco protegido com um AIRBAG ACTIVO na frente do mesmo, poderá ocorrer a PERDA DE VIDA ou FERIMENTOS GRAVES na CRIANÇA.

IT: Non usare mai un sistema di sicurezza per bambini rivolto all'indietro su un sedile protetto da AIRBAG ATTIVO di fronte ad esso: pericolo di MORTE o LESIONI GRAVI per il BAMBINO!

EL: ΠΟΤΕ μη χρησιμοποιείτε παιδικό κάθισμα ασφαλείας με φορά προς τα πίσω σε κάθισμα που προστατεύεται από μετωπικό ΕΝΕΡΓΟ ΑΕΡΟΣΑΚΟ, διότι το παιδί μπορεί να υποστεί ΘΑΝΑΣΙΜΟ ή ΣΟΒΑΡΟ ΤΡΑΥΜΑΤΙΣΜΟ.

PL: NIE WOLNO montować fotelika dziecięcego zwróconego tyłem do kierunku jazdy na fotelu, przed którym znajduje się WŁĄCZONA PODUSZKA POWIETRZNA. Niezastosowanie się do tego

zalecenia może być przyczyną ŚMIERCI lub POWAŻNYCH OBRAŻEŃ u DZIECKA.

TR: Arkaya bakan bir çocuk emniyet sistemini KESİNLİKLE önünde bir AKTİF HAVA YASTIĞI ile korunmakta olan bir koltukta kullanmayınız. ÇOCUK ÖLEBİLİR veya AĞIR ŞEKİLDE YARALANABİLİR.

UK: НИКОЛИ не використовуйте систему безпеки для дітей, що встановлюється обличчям назад, на сидінні з УВІМКНЕНОЮ ПОДУШКОЮ БЕЗПЕКИ, інакше це може призвести до СМЕРТІ чи СЕРІОЗНОГО ТРАВМУВАННЯ ДИТИНИ.

HU: SOHA ne használjon hátrafelé néző biztonsági gyerekülést előlről AKTÍV LÉGZSÁKKAL védett ülésen, mert a GYERMEK HALÁLÁT vagy KOMOLY SÉRÜLÉSÉT okozhatja.

HR: NIKADA nemojte koristiti sustav zadržavanja za djecu okrenut prema natrag na sjedalu s AKTIVNIM ZRAČNIM JASTUKOM ispred njega, to bi moglo dovesti do SMRTI ili OZBILJNJIH OZLJEDA za DIJETE.

SL: NIKOLI ne nameščajte otroškega varnostnega sedeža, obrnjenega v nasprotni smeri vožnje, na sedež z AKTIVNO ČELNO ZRAČNO BLAZINO, saj pri tem obstaja nevarnost RESNIH ali SMRTNIH POŠKODB za OTROKA.

SR: NIKADA ne koristiti bezbednosni sistem za decu u kome su deca okrenuta unazad na sedištu sa AKTIVNIM VAZDUŠNIM JASTUKOM ispred sedišta zato što DETE može da NASTRADA ili da se TEŠKO POVREDI.

MK: НИКОГАШ не користете детско седиште свртено наназад на седиште заштитено со АКТИВНО ВОЗДУШНО ПЕРНИЧЕ пред него, затоа што детето може ДА ЗАГИНЕ или да биде ТЕШКО ПОВРЕДЕНО.

BG: НИКОГА не използвайте детска седалка, гледаща назад, върху седалка, която е защитена чрез АКТИВНА ВЪЗДУШНА ВЪЗГЛАВНИЦА пред нея - може да се стигне до СМЪРТ или СЕРИОЗНО НАРАНЯВАНЕ на ДЕТЕТО.

RO: Nu utilizați NICIODATĂ un scaun pentru copil îndreptat spre partea din spate a mașinii pe un scaun protejat de un AIRBAG ACTIV în fața sa; acest lucru poate duce la DECESUL sau VĂTĂMAREA GRAVĂ a COPILULUI.

CS: NIKDY nepoužívejte dětský zádržný systém instalovaný proti směru jízdy na sedadle, které je chráněno před sedadlem AKTIVNÍM AIRBAGEM. Mohlo by dojít k VÁŽNĚMU PORANĚNÍ nebo ÚMRTÍ DÍTĚTE.

SK: NIKDY nepoužívajte detskú sedačku otočenú vzad na sedadle chránenom AKTÍVNYM AIRBAGOM, pretože môže dôjsť k SMRTI alebo VÁŽNYM ZRANENIAM DIEŤAŤA.

LT: JOKIU BŪDU nemontuokite atgal atgręžtos vaiko tvirtinimo sistemas sėdynėje, prieš kurią įrengta AKTYVI ORO PAGALVĖ, nes VAIKAS GALI ŽŪTI arba RIMTAI SUSIŽALOTI.

LV: NEKĀDĀ GADĪJUMĀ neizmantojiet uz aizmuguri vērstu bērnu sēdekļiti sēdvietā, kas tiek aizsargāta ar tās priekšā uzstādītu

AKTĪVU DROŠĪBAS SPILVENU, jo pretējā gadījumā BĒRNS var gūt SMAGAS TRAUMAS vai IET BOJĀ.

ET: ĀRGE kasutage tahapoole suunatud lapseturvaistet istmel, mille ees on AKTIIVSE TURVAPADJAGA kaitstud iste, sest see vōib pōhjustada LAPSE SURMA vōi TÕSISE VIGASTUSE.

MT: QATT tuža tražžin għat-*tfal* li jħares lejn in-naħa ta' wara fuq sit protett b'AIRBAG ATTIV quddiemu; dan jista' jikkawħa l-MEWT jew GRIEHI SERJI lit-TFAL.

GA: Nā hūsāid srian sábháilteachta linbh cúil RIAMH ar shuíochán a bhfuil mála aeir ag feidhmiú os a chomhair. Tá baol BÁIS nó GORTÚ DONA don PHÁISTE ag baint leis.

Additionally, for safety reasons a forward-facing child restraint system must only be used subject to the instructions and restrictions in the table ⇨ 43.

The airbag label is located on both sides of the front passenger sun visor.

Airbag deactivation ⇨ 38.

Front airbag system

The front airbag system consists of one airbag in the steering wheel and one in the instrument panel on the front passenger side. These can be identified by the word **AIRBAG**.

The front airbag system is triggered in the event of a front-end impact of a certain severity. The ignition must be switched on.

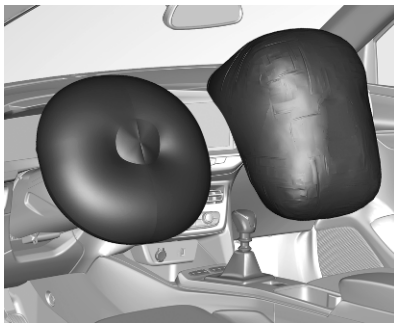

The inflated airbags cushion the impact, thereby reducing the risk of injury to the upper body and head of the front seat occupants considerably.

⚠ Warning

Optimum protection is only provided when the seat is in the proper position.

Seat position ⇨ 27.

Fasten the seat belt correctly and engage securely. Only then is the airbag able to protect.

Side airbag system



The side airbag system consists of an airbag in each front seat backrest and in the rear outer seat backrests. This can be identified by the word **AIRBAG**.

The side airbag system is triggered in the event of a side impact of a certain severity. The ignition must be switched on.



The inflated airbags cushion the impact, thereby reducing the risk of injury to the upper body and pelvis in the event of a side-on collision considerably.

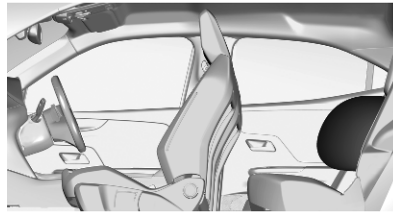

Notice

Only use protective seat covers that have been approved for the vehicle. Be careful not to cover the airbags.

Curtain airbag system

The curtain airbag system consists of an airbag in the roof frame on each side. This can be identified by the word **AIRBAG** on the roof pillars.

The curtain airbag system is triggered in the event of a side-on impact of a certain severity. The ignition must be switched on.

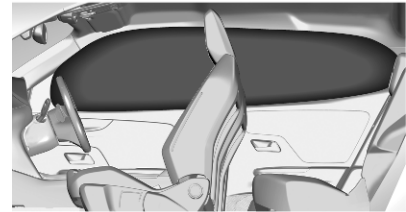

The inflated airbags cushion the impact, thereby reducing the risk of injury to the head in the event of a side-on impact considerably.

Warning

The hooks on the handles in the roof frame are only suitable for hanging up light articles of clothing, without coat hangers. Do not keep any items in these clothes.

Airbag deactivation

The front passenger airbag system must be deactivated for child restraint system on the passenger seat according to the instructions in the table ↗ 43.

The side airbag and curtain airbag systems, the belt pretensioners and all driver airbag systems will remain active.

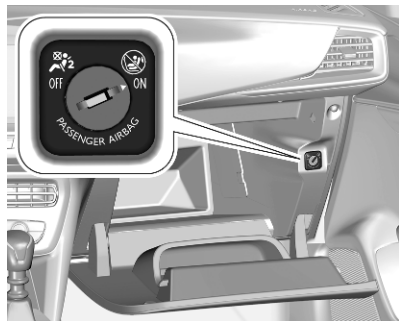

The front passenger airbag system can be deactivated via a key-operated switch in the glovebox.

Use the ignition key to choose the position:

OFF : front passenger airbag is deactivated and will not inflate in the event of a collision, control indicator OFF illuminates continuously in the centre console.

ON : front passenger airbag is active.

Notice

After turning the key-operated switch to position OFF , keep on turning towards this position until key is removed.

Danger

Deactivate passenger airbag only in combination with the use of a child restraint system, subject to the instructions and restrictions in the table ↗ 43.

Otherwise, there is a risk of fatal injury for a person occupying a seat with a deactivated front passenger airbag.



If the control indicator illuminates for approx. 60 seconds after the ignition is switched on, the front passenger airbag system will inflate in the event of a collision.

If the control indicator illuminates after the ignition is switched on, the front passenger airbag system is deactivated. It stays on while the airbag is deactivated.

If both control indicators are illuminated at the same time, there is a system failure. The status of the system is not discernible, therefore no person is allowed to occupy the front passenger seat. Contact a workshop immediately.

Consult a workshop immediately if neither of the two control indicators are illuminated.

Change status only when the vehicle is stopped with the ignition off.

Status remains until the next change.

Control indicator for airbag deactivation ⇨ 70.

Child restraints

Child restraint systems

Danger

Make sure that children below sufficient size and weight are protected using a suitable child restraint system. Never place a child on the lap.

Danger

If using a rear-facing child restraint system on the front passenger seat, the airbag system for the front passenger seat must be deactivated. This also applies to certain forward-facing child restraint systems as indicated in the tables ⇨ 43.

Airbag deactivation ⇨ 38.

Airbag label ⇨ 33.

We recommend a child restraint system which is tailored specifically to the vehicle. For further information, contact your workshop.

In case of any interference of the child restraint system with vehicle seat head restraint, adjust or remove the corresponding head restraint ⇨ 26.

When a child restraint system is being used, pay attention to the following usage and installation instructions and also those supplied with the child restraint system. The given restrictions in the table refer to a test body, which is the maximum envelope of all existing child restraint systems. Make sure that the front seats do not interfere with the used child restraint system.

Always comply with local or national regulations. In some countries, the use of child restraint systems is forbidden on certain seats.

Only drive with the driver seat correctly adjusted ⇨ 27.

Child restraint systems can be fastened with:

- Three-point seat belt
- ISOFIX brackets
- Top-tether

Three-point seat belt

Child restraint systems can be fastened by using a three-point seat belt. After fastening the child restraint system the seat belt has to be tightened.

ISOFIX brackets



Fasten vehicle-approved ISOFIX child restraint systems to the ISOFIX brackets. Specific vehicle ISOFIX child restraint system positions are marked in the ISOFIX table ↻ 43.



ISOFIX brackets are indicated by a label on the backrest. To get access to the ISOFIX brackets, first pull the zipper.

When fastening ISOFIX child restraint systems on adjustable passenger seats, such as the front passenger seat, first incline the backrest as far as necessary backwards in order to get access to the ISOFIX brackets. After

the proper fastening of the ISOFIX child restraint system, incline the backrest forward again.

An i-Size child restraint system is an universal ISOFIX child restraint system according UN Regulation No. 129.

All i-Size child restraint systems can be used on any vehicle seat suitable for i-Size, i-Size table ↻ 43.

Either a Top-tether strap or a support leg must be used in addition to the ISOFIX brackets.



i-Size child seats and vehicle seats with i-Size approval are marked with i-Size symbol, see illustration.

Top-tether anchors



Top-tether anchors are marked with the symbol  for a child seat.



In addition to the ISOFIX brackets, fasten the Top-tether strap to the Top-tether anchors.

ISOFIX child restraint systems of universal category positions are marked in the table by IUF ⇨ 43.

Selecting the right system

The rear seats are the most convenient location to fasten a child restraint system.

Children should travel facing rearwards in the vehicle as long as possible. This makes sure that the child's backbone, which is still very weak, is under less strain in the event of an accident. Do not use forward facing child restraint system at all seats when child's weight is below 13 kg.

Suitable are child restraint systems that comply with valid UN ECE regulations. Check local laws and regulations for mandatory use of child restraint systems.

The following child restraints are recommended for the following weight classes:

- **Group 0, Group 0+:**
Maxi Cosi Cabriofix with or without ISOFIX base for children up to 13 kg
- **Group I:** Duo Plus with ISOFIX and Top-tether for children from 9 kg to 18 kg
- **Group II:** Kidfix XP with or without ISOFIX for children from 15 kg to 36 kg,
Kidfix 2R with or without ISOFIX for children from 15 kg to 36 kg, for Kidfix 2R ensure that vehicle seat belt passes through secure guard.
Graco Booster for children from 15 kg to 36 kg.
- **Group III:** Kidfix XP / Kidfix 2R with or without ISOFIX for children from 22 kg to 36 kg
Graco Booster for children from 22 kg to 36 kg

Ensure that the child restraint system to be installed is compatible with the vehicle type.

Child seat at the front: Adjust the front passenger seat to the highest and fully back longitudinal position with the backrest straightened.

Child seat at the rear: Move the vehicle's front seat forward and straighten the backrest so that the legs of the child in the "forward facing" or the "rearward facing" child seat do not touch the vehicle's front seat.

In case of any interference of Child restraint system with vehicle seat head rest, adjust or remove the corresponding vehicle seat Head rest.

Do not use forward facing child restraints system when child's weight is below 13 kg at all seats.

Please follow Child restraint manufacturers instructions to install corresponding child restraints in vehicle.

For semi-universal or vehicle specific child restraint system (ISOFIX or belted child restraint system), see the vehicle list provided in the user manual of the child restraint system.

Ensure that the mounting location of the child restraint system within the vehicle is correct, see following table.

Allow children to enter and exit the vehicle only on the side facing away from the traffic.

When the child restraint system is not in use, secure the seat with a seat belt or remove it from the vehicle.

Notice

Do not affix anything on the child restraint systems and do not cover them with any other materials.

A child restraint system which has been subjected to stress in an accident must be replaced.

Child restraint installation locations

Installation of universal, ISOFIX and i-Size child seats

As required by European regulations, this table gives the options for installing child seats secured using the seat belt and universally approved as well as the larger ISOFIX and i-Size child seats on seat positions equipped with ISOFIX mountings in the vehicle.

Yes : Suitable for fitment of the designated category of the child restraint system.

No : Not suitable for fitment of the designated category of the child restraint system.

Child restraint system categories	Front passenger seat with activated airbag ON	Front passenger seat with deactivated airbag OFF	Rear outer seats	Rear centre seat ¹⁾
Universal belted child restraint system ²⁾	Yes ^{3) 4) 5)}	Yes ^{4) 6) 7)}	Yes	NO
i-size child restraint system	Yes ^{3) 8)}	Yes ^{6) 8)}	Yes	–
Position equipped with a Top-tether fixing	Yes ^{3) 8)}	Yes ^{6) 8)}	Yes	–
Carry-cot (ISOFIX lateral facing child restraint system) ISOFIX child restraint fixture: L1, L2	NO	NO	NO	–
ISOFIX rearward facing child restraint system ISOFIX child restraint fixture: R1, R2	NO	Yes ^{8) 9) 12)}	Yes ^{10) 11) 12)}	–

44 Seats, restraints

Child restraint system categories	Front passenger seat with activated airbag ON	Front passenger seat with deactivated airbag OFF	Rear outer seats	Rear centre seat ¹⁾
ISOFIX forward facing child restraint system ISOFIX child restraint fixture: F2, F2X, F3	Yes ^{8) 12)}	NO	Yes ¹²⁾	–
ISOFIX rearward facing child restraint system ISOFIX child restraint fixture: R3	NO	NO	Yes ^{10) 11) 12)}	–
Booster seat - reduced width: B2	Yes	NO	Yes	NO
Booster seat - full width: B3	Yes	NO	Yes	NO

1) Child restraint system installation is not allowed on rear centre seat.

2) Universal child seat: child seat that can be installed in all vehicles using the seat belt. Applies to all stature and mass groups.

3) Only forward facing child restraint system

4) For a seat with height adjustment, set it to the highest and fully back longitudinal position.

5) Only a forward facing child restraint system is authorised at this seat position with the front passenger's airbag activated ON.

6) Only rearward facing child restraint system

7) To install a rearward facing child restraint system at this seat position, the front passenger's airbag must be deactivated OFF.

8) Seats fitted with ISOFIX / i-Size compliant mountings.

9) The vehicle seat must be adjusted in the rearmost longitudinal position.

10) Adjust the driver seat ahead of the child restraint system to the longitudinal middle and maximum height position. If necessary, adjust the driver's seat backrest angle. Ensure that inclination angle of the backrest does not exceed the corresponding torso angle of 15°.

11) Move the passenger seat ahead of the child restraint system forwards as far as necessary.

12) In case of any interference of Child restraint system with vehicle seat head rest, adjust or remove the corresponding vehicle seat head rest.

Size of child restraint fixture (1, 2, 3):

- R1 means rearward facing child restraint fixture for mass group 0 up to 10 kg and mass group 0+ up to 13 kg, age around 0-1 year.
- R2 means reduced size of rearward facing child restraint fixture for mass group 0+ up to 13 kg and mass group 1 from 9 to 18 kg, age around 2-4 years.
- R3 means full size of rearward facing child restraint fixture for mass group 0+ up to 13 kg and mass group 1 from 9 to 18 kg, age around 2-4 years.
- F2, F2X mean reduced height of forward facing child restraint fixture for mass group 1 from 9 to 18 kg, age around 6-7 years.
- F3 means full height of forward facing child restraint fixture for mass group 1 from 9 to 18 kg, age around 7-10 years.

Storage

Storage compartments	46
Glovebox	46
Cupholders	46
Door panel storage	47
Centre console storage	47
Load compartment	48
Load compartment cover	49
Rear floor storage cover	49
Lashing eyes	50
Warning triangle	50
Roof rack system	51
Roof rack	51
Loading information	51

Storage compartments

⚠ Warning

Do not store heavy or sharp objects in the storage compartments.

Glovebox



Pull lever to open the glovebox.

The glovebox should be closed whilst driving.

Cupholders

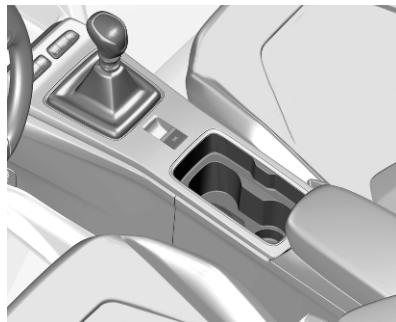

Cupholders are located in the centre console.

Door panel storage

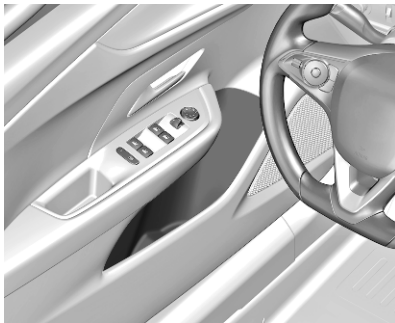

A storage compartment is located in the front and rear door panels.

Centre console storage



Slide armrest backwards, push button and fold upwards. Under the armrest there is a storage compartment.

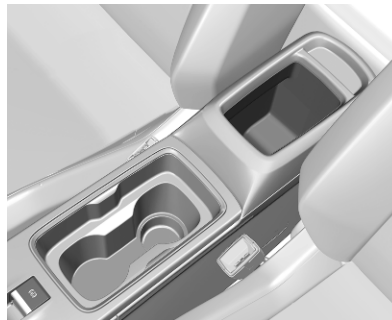

A storage compartment is located in the centre console.

Load compartment

The rear seat backrest is divided into 2/3 to 1/3 parts. Both parts can be folded down individually to increase the size of the load compartment.

Before folding rear seat backrests, execute the following if necessary:

- Move front seats forward if necessary.
- Remove the load compartment cover ↻ 49.
- Press and hold the catch to push the head restraints down ↻ 26.

Folding down/up rear backrests

- Check that the seat belts are not engaged in the seat belt buckles, so that the backrests can be moved.



- Pull the release lever on one or both outer sides and fold down the backrests onto the seat cushion.
- To fold up, raise the backrests and guide them into an upright position until they engage audibly. Make sure that the belts are positioned correctly and stay clear of the folding area.

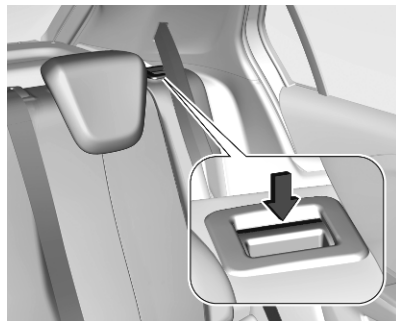

The backrests are properly engaged when the red marks near the release levers are no longer visible.

⚠ Warning

When folding up, ensure that backrests are securely locked in position before driving. Failure to do so may result in personal injury or damage to the load or vehicle in the event of hard braking or a collision.



The seat belt of the centre seat could be blocked when the backrest is folded up too quickly. To unlock the retractor, push in the seat belt or pull it out by approx. 20 mm then release.

Load compartment cover

Do not place any objects on the cover.

Removing cover



Unhook retaining straps from tailgate.

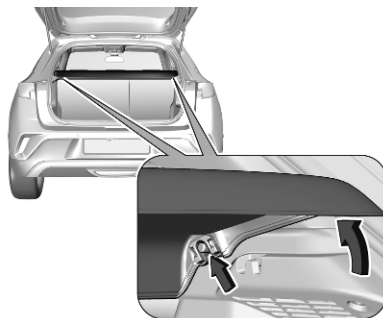

Lift cover at the front and push it upwards at the rear.

Remove the cover.

Fitting cover

Engage cover in side guides and fold downwards. Attach the retaining straps to the tailgate.

Rear floor storage cover

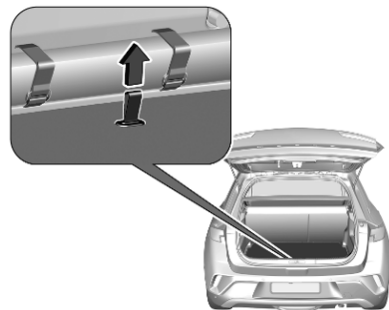

The rear floor cover can be lifted and removed. Use opening to raise the rear floor cover and then remove it.

Double load floor

The double load floor can be inserted in the load compartment in two positions:

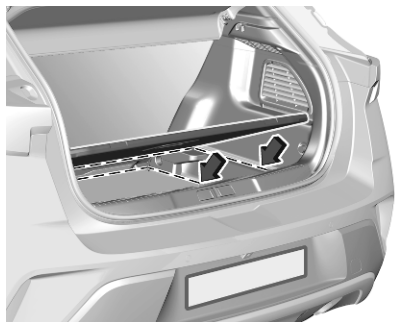

- lower position above the rear floor storage cover
- upper position interlocked into back panel trim

To remove, use opening to raise the rear floor cover and lift it up.

If mounted in the upper position, the space between the load floor and the spare wheel well cover can be used as a storage compartment.

In this position, if the rear seat backrests are folded forwards, an almost completely flat load bay is created.

In the upper position, the double load floor is able to withstand an equally distributed maximum load of 60 kg. In the lower position, the double load floor is able to withstand the maximum permissible load.

Lashing eyes

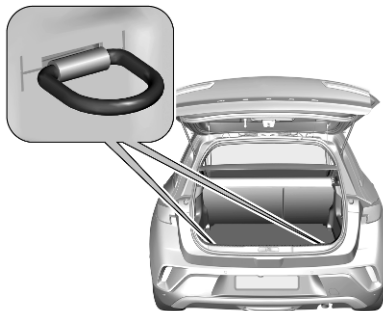

The lashing eyes are designed to secure items against slippage, e.g. using lashing straps or luggage net.

Warning triangle

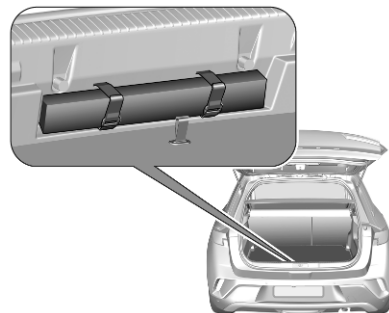

Stow the warning triangle in the space at the rear of the load compartment and secure it with the Velcro® fastener.

Roof rack system

Roof rack

For safety reasons and to avoid damage to the roof, the vehicle approved roof rack system is recommended. For further information, contact your workshop.



Open all doors.

Mounting points are located in each door frame of the vehicle body.

Fasten the roof rack according to the installation instructions delivered with the roof rack.

Remove the roof rack when not in use.

Loading information

Warning

Always make sure that the load in the vehicle is securely stowed. Otherwise objects can be thrown around inside the vehicle and cause personal injury or damage to the load or car.

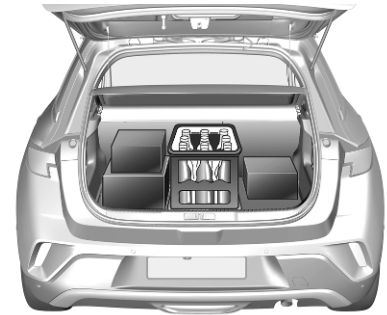

- Heavy objects in the load compartment should be placed against the seat backrests. Make sure that the backrests are

securely engaged. If objects can be stacked, heavier objects should be placed at the bottom.

- Prevent sliding of loose objects by securing them with straps attached to the lashing eyes ⇨ 50.
- Do not allow the load to protrude above the upper edge of the backrests.
- Do not place any objects on the load compartment cover or the instrument panel, and do not cover the sensor on top of the instrument panel.
- The load must not obstruct the operation of the pedals, parking brake and gear selector, or hinder the freedom of movement of the driver. Do not place any unsecured objects in the interior.
- Do not drive with an open load compartment.
- The payload is the difference between the permitted gross vehicle weight (see identification plate ⇨ 285) and the EC kerb weight.

To calculate the payload, enter the data for your vehicle in the weights table at the front of this manual.

The EC kerb weight includes weights for the driver (68 kg), luggage (7 kg) and all fluids (fuel tank 90% full).

Optional equipment and accessories increase the kerb weight.

- Driving with a roof load increases the sensitivity of the vehicle to cross-winds and has a detrimental effect on vehicle handling due to the vehicle's higher centre of gravity. Distribute the load evenly and secure it properly with retaining straps. Adjust the tyre pressure and vehicle speed according to the load conditions. Check and retighten the straps frequently. Do not drive faster than 75 mph. The permissible roof load is 75 kg. The roof load is the combined weight of the roof rack and the load.

Instruments and controls

Instrument panel overview 55

Controls 57

Steering wheel adjustment 57

Steering wheel controls 57

Heated steering wheel 57

Horn 58

Pedestrian safety alert 58

Windscreen wiper and washer .. 58

Rear window wiper and

washer 60

Outside temperature 60

Clock 61

Power outlets 61

Inductive charging 62

Warning lights, gauges and indicators 63

Speedometer 63

Odometer 63

Tachometer 64

Fuel gauge 64

High voltage battery gauge 65

Power indicator gauge 65

Total vehicle range 66

Engine coolant temperature

gauge 66

Engine oil level monitor 66

Service display 66

Control indicators 67

Turn lights 69

Seat belt reminder 69

Airbag and belt tensioners 70

Airbag deactivation 70

Charging system 70

Malfunction indicator light 70

Service vehicle soon 71

Stop engine 71

System check 71

Brake and clutch system 71

Parking brake 71

Electric parking brake fault 72

Automatic operation of electric

parking brake off 72

Antilock brake system (ABS) 72

Gear shifting 72

Lane keep assist 72

Advanced lane keep assist 73

Parking assist 73

Electronic Stability Control and

Traction Control system 73

Engine coolant temperature 73

Preheating 73

Exhaust filter 73

AdBlue 74

Deflation detection system 74

Engine oil pressure 74

Low fuel 75

Charging cable connected 75

Vehicle ready 75

Reduced engine power 75

High voltage battery

temperature high 75

Autostop 75

Exterior light 75

Low beam 75

High beam 76

High beam assist 76

LED headlights 76

Front fog lights 76

Rear fog light 76

Rain sensor 76

Pedestrian safety alert fault 76

Active emergency braking 76

Traffic sign assistant 76

Door open 77

Displays 77

Driver Information Centre 77

Info Display 78

Vehicle messages 80

Warning chimes 80

Vehicle personalisation 81

Telematics services	82
Vauxhall Connect	82
Emergency call	82

Instrument panel overview

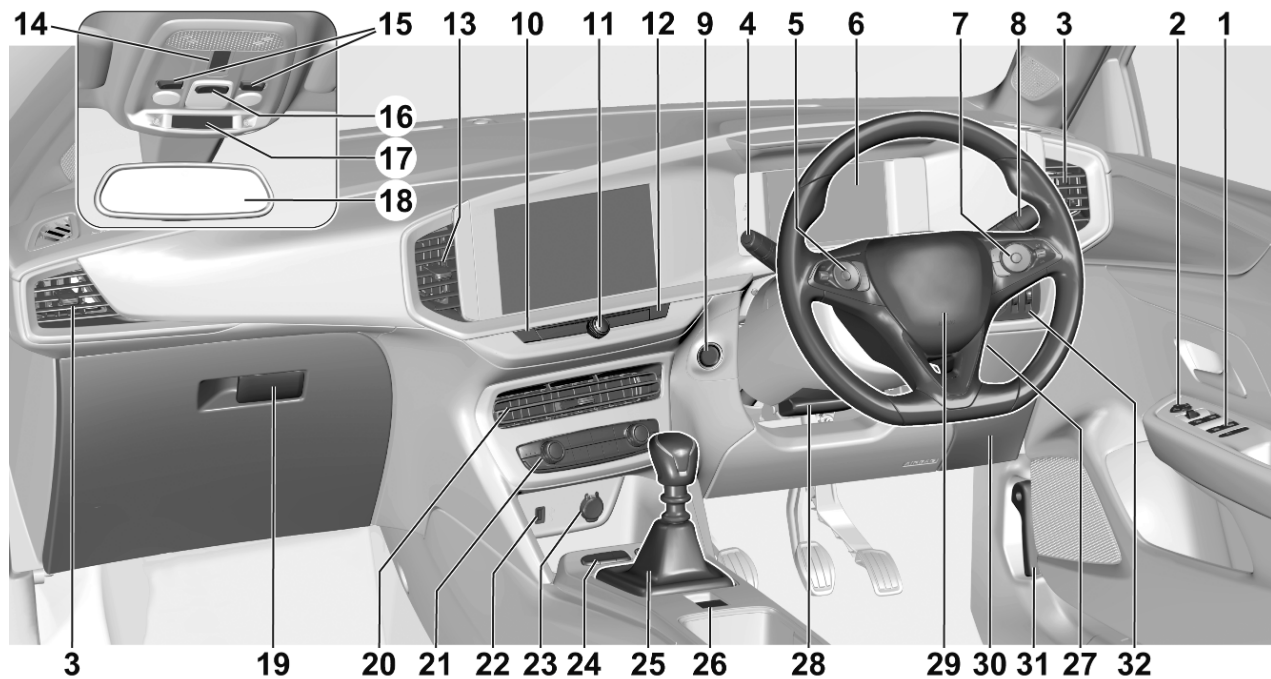

- | | | | | | | | | |
|----|--|-----|----|---------------------------------|-----|----|--|-----|
| 1 | Power windows | 23 | 13 | Centre air vents | 159 | 30 | Fuse box | 260 |
| 2 | Exterior mirrors | 20 | 14 | Vauxhall Connect | 82 | 31 | Bonnet release lever | 251 |
| 3 | Side air vents | 159 | 15 | Reading lights | 91 | 32 | Light switch | 84 |
| 4 | Turn lights, headlight
flash, low / high beam | 89 | 16 | Interior lights | 91 | | Headlight range
adjustment | 86 |
| | Parking lights | 90 | 17 | Seat belt reminder | 30 | | Front fog lights | 89 |
| | Buttons for Driver
Information Centre | 77 | | Airbag deactivation | 38 | | Rear fog light | 90 |
| 5 | Cruise control | 188 | 18 | Interior mirror | 21 | | Instrument panel
illumination | 91 |
| | Speed limiter | 190 | 19 | Glovebox | 46 | | | |
| | Adaptive cruise control | 192 | 20 | Centre air vents | 159 | | | |
| | Heated steering wheel | 57 | 21 | Climate control system | 154 | | | |
| 6 | Instruments | 63 | 22 | USB port | 61 | | | |
| | Driver Information Centre | 77 | 23 | Power outlet | 61 | | | |
| 7 | Infotainment controls | | 24 | Parking assist | 205 | | | |
| 8 | Windscreen wiper and
washer, rear wiper and
washer | 58 | | Lane departure warning | 223 | | | |
| 9 | Power button | 164 | | Lane keep assist | 224 | | | |
| 10 | Central locking system | 10 | | Advanced lane keep assist | 226 | | | |
| 11 | Controls for Info Display
operation | 78 | | Stop start system | 167 | | | |
| 12 | Hazard warning flashers | 88 | 25 | Selector lever | 180 | | | |
| | | | 26 | Parking brake | 183 | | | |
| | | | 27 | Ignition switch | 164 | | | |
| | | | 28 | Steering wheel adjustment | 57 | | | |
| | | | 29 | Horn | 58 | | | |

Controls

Steering wheel adjustment

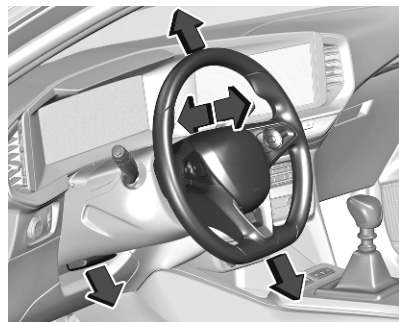

Unlock lever, adjust steering wheel, then engage lever and ensure it is fully locked.

Do not adjust steering wheel unless vehicle is stationary and, depending on version, the steering wheel lock has been released.

Steering wheel controls

Some driver assistance systems, Infotainment system and a connected mobile phone can be operated via the controls on the steering wheel.



Further information is available in the respective infotainment system section ↗ 93.

Cruise control ↗ 188.

Speed limiter ↗ 190.

Adaptive cruise control ↗ 192.

Heated steering wheel



Activate heating by pressing . Activation is indicated by the LED in the button.

The heating works only when the outside temperature is below 20 °C.

Stop-start system ↗ 167.

Horn

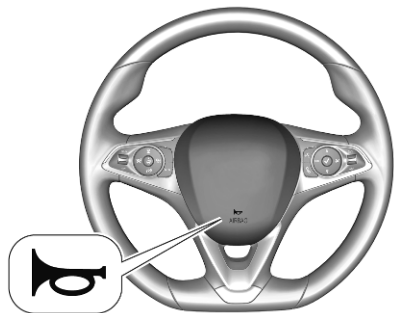

Press .

Pedestrian safety alert

The sound of the pedestrian safety alert is generated to indicate the vehicle presence to pedestrians. It is active up to 19 mph.

Windscreen wiper and washer

Windscreen wiper with adjustable wiper frequency

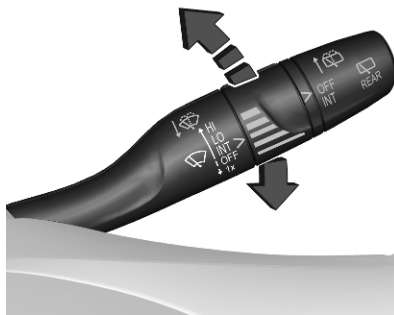

- HI** : fast
- LO** : slow
- INT** : interval wiping
- OFF** : off
- 1x** : single wipe

Do not use if the windscreen is frozen.
Switch off in car washes.

To activate interval wiping mode the next time ignition is switched on, press the lever downwards to position **OFF** and back to **INT**.

Adjustable wiper frequency

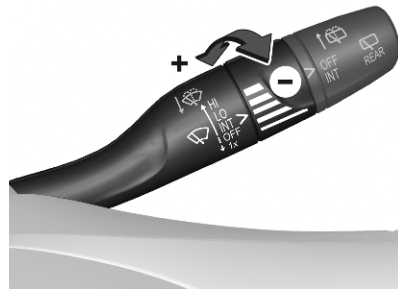

Wiper lever in position **INT**.

Turn the adjuster wheel to adjust the desired wipe frequency.

Windscreen wiper with rain sensor

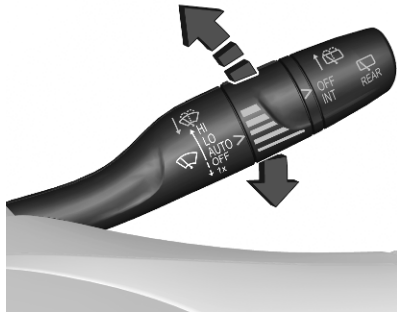

- HI** : fast
- LO** : slow
- AUTO** : automatic wiping with rain sensor
- OFF** : off
- 1x** : single wipe

In **AUTO** position, the rain sensor detects the amount of water on the windscreen and automatically regulates the frequency of the windscreen wiper.  illuminates in the Driver Information Centre.

For a single wipe when the windscreen wiper is off, press the lever downwards to position **1x**.
Do not use if the windscreen is frozen.
Switch off in car washes.



Keep the sensor free from dust, dirt and ice.

Adjustable sensitivity of the rain sensor

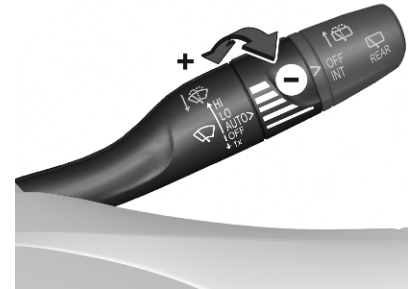

Turn the adjuster wheel to adjust the sensitivity.

Windscreen washer



Pull lever. Washer fluid is sprayed onto the windscreen and the wiper wipes a few times.

Washer fluid ↪ 254.

Rear window wiper and washer

Rear window wiper



OFF : off
INT : intermittent operation

Do not use if the rear window is frozen.

Switch off in car washes.

The rear window wiper comes on automatically when the windscreen wiper is switched on and reverse gear is engaged.

Activation or deactivation of this function can be changed in the Vehicle personalisation menu ↪ 81.

Rear window washer

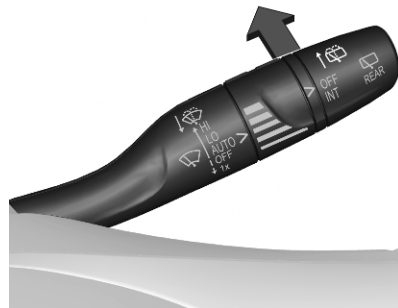

Push lever.

Washer fluid is sprayed onto the rear window and the wiper wipes a few times.

Washer fluid ↪ 254.

Outside temperature

A drop in temperature is indicated immediately and a rise in temperature after a time delay.



Illustration shows an example.

If outside temperature drops to a certain temperature, a warning message is displayed in the Driver Information Centre.

⚠ Warning

The road surface may already be icy even though the display indicates a few degrees above 0 °C.

Clock

Date and time are shown in the Info Display.

Power outlets

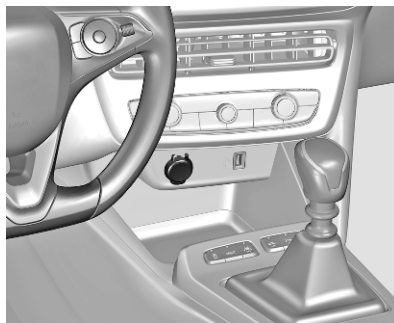

Do not exceed the maximum power consumption of 120 W.

The 12 V power outlet is deactivated in the event of low vehicle battery voltage.

Electrical accessories that are connected must comply with the electromagnetic compatibility requirements laid down in DIN VDE 40 839.

Do not connect any current-delivering accessories, e.g. electrical charging devices or batteries.

Do not damage the outlet by using unsuitable plugs.

Stop-start system ↪ 167.

USB ports

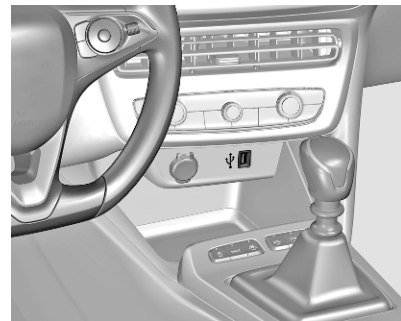

The USB port provides 5 V.

Notice

The sockets must always be kept clean and dry.

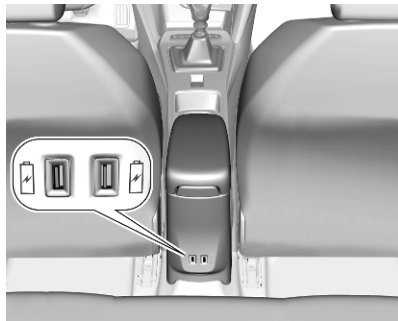
Rear USB ports

The slot below the USB ports on the rear side of the storage container is intended to attach an accessory cupholder.

Inductive charging**⚠ Warning**

Inductive charging can affect the operation of implanted pacemakers or other medical devices. If applicable, seek medical advice before using the inductive charging device.

⚠ Warning

Remove any metal objects from the charging device before charging a mobile device, as these objects could become very hot.

To charge a mobile device:

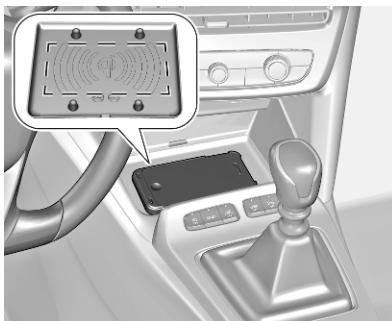

1. Remove all objects from the charging device.
2. Place the mobile device with the display facing upwards on the charging area. Note that the mobile device must be placed between the positioning aids.

Qi compatible mobile devices can be charged inductively.

On some mobile devices, a back cover with an integrated coil or a jacket may be required to use inductive charging.

Protective cover for the mobile device could have impact on the inductive charging.

In the event that the mobile device is not charging properly, rotate it 180° and place it on the charging device again.

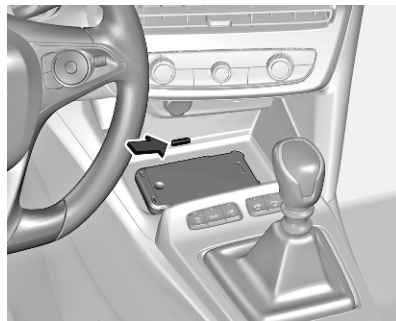
Status LED

The LED indicates the current charging status.

Illuminates green

The mobile device is charging.

Flashes yellow

The mobile device has not been centred properly in the charging zone or an unknown object has been detected in the charging zone.

Illuminates yellow

There is a problem with the mobile device's battery or a fault of the inductive charger has been detected.

If the problem persists, seek the assistance of a workshop.

Warning lights, gauges and indicators

Speedometer

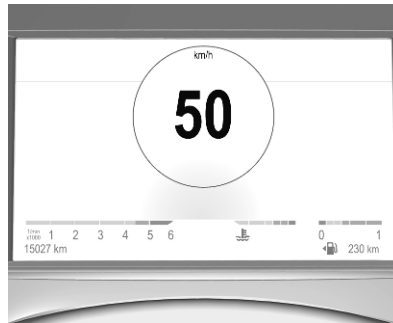

Indicates vehicle speed.

Odometer

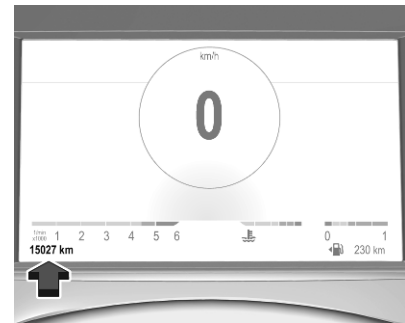

The total recorded distance is displayed in miles.

Tachometer

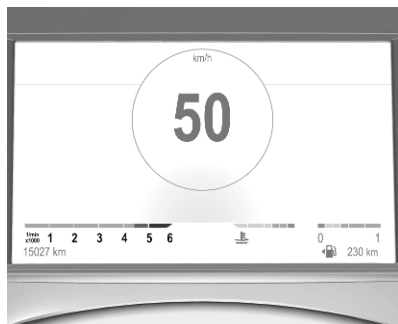

Depending on version, two variants are available.

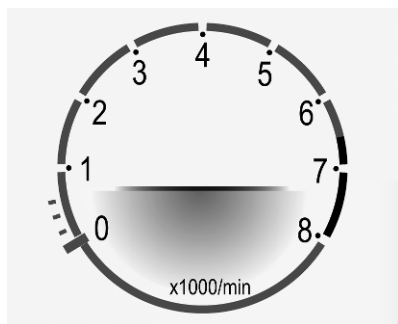

Displays the engine speed.

Drive in a low engine speed range for each gear as much as possible.

A red marker indicates the beginning of the warning zone of excessive revolutions. For Diesel engines, the warning zone starts at 5000 revolutions per minute. For petrol engines, the warning zone starts at 6500 revolutions per minute.

Caution

If the indicator is in the red warning zone, the maximum permitted engine speed is exceeded. The engine can be damaged.

Fuel gauge

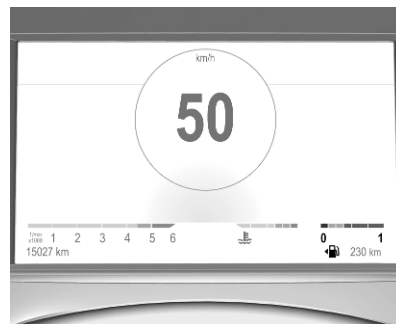

Depending on version, two variants are available.

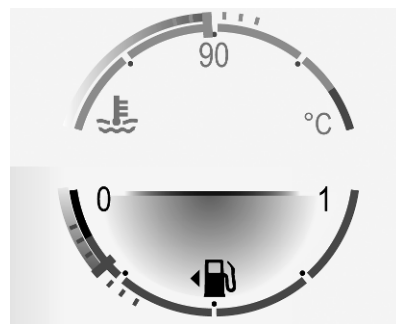

Control indicator  illuminates yellow if the fuel level is low.

Never run the fuel tank dry.

The top-up quantity may be less than the specified fuel tank capacity, due to the remaining fuel in the tank.

High voltage battery gauge

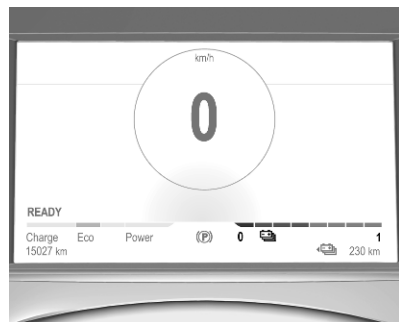

Depending on version, two variants are available.

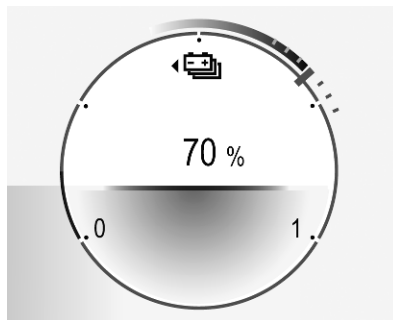

Displays the high voltage battery state of charge.

Power indicator gauge

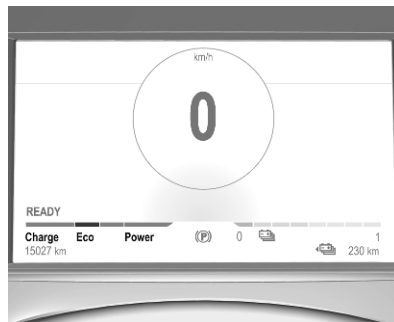

Depending on version, two variants are available.

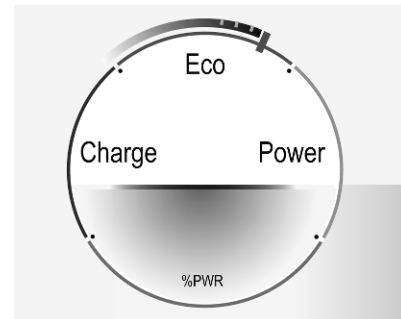

The power indicator gauge informs about the current energy situation of the vehicle.

- Charge : Battery is being charged with energy resulting from braking or deceleration of the vehicle
- Eco : An optimum in energy is accessible in all driving modes
- Power : Vehicle is driven in a dynamic driving style with focus on performance

Total vehicle range

Displays the total vehicle range.

Engine coolant temperature gauge

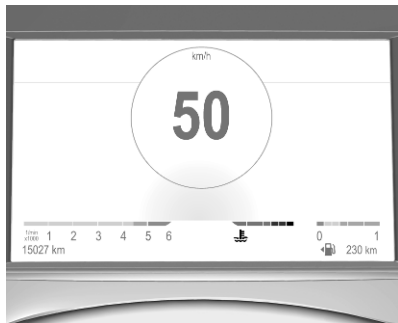

Depending on version, two variants are available.

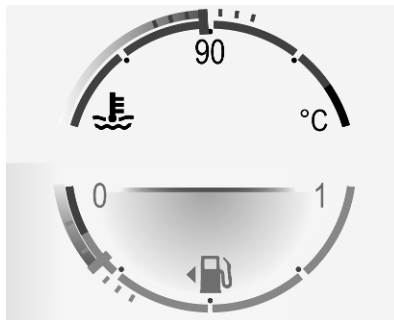

Displays the coolant temperature.

grey marking / : normal operating temperature
90
red marking : temperature too high

Control indicator  illuminates red if coolant temperature is too high.



Caution

If engine coolant temperature is too high, stop vehicle, switch off engine. Danger to engine. Check coolant level.

Engine oil level monitor

The state of the engine oil level is displayed in the Driver Information Centre for a few seconds following the service information after switching on the ignition.

A proper state of engine oil level is indicated by a message.

If engine oil level is low,  flashes and a message is indicated, accompanied by the  indicator.

Confirm engine oil level by using the dipstick and top up engine oil respectively.

Engine oil ⇨ 251.

A fault of measurement is indicated by a message. Check engine oil level manually by using the dipstick.

Service display

The service system informs when to change the engine oil and filter or a vehicle service is required. Based on driving conditions, the interval at which an engine oil and filter change are required can vary considerably.

Service information ⇨ 280.

A required service due is displayed in the Driver Information Centre for several seconds after switching on the ignition.

If no service is required for the next 1800 miles or more, no service information appears in the display.

If service is required within the next 1800 miles, the remaining distance to the next service due, the distance travelled since the last service due or the time period that remains to the next service due is indicated for several seconds. Simultaneously symbol  illuminates temporary as reminder.

If service is required in less than 600 miles, the remaining distance to the next service due, the distance travelled since the last service due or the time period that remains to the next service due is indicated for several seconds. Simultaneously  illuminates permanently as reminder.

Overdue service is indicated by a message in the Driver Information Centre which indicates the overdue

distance.  flashes and then illuminates permanently until service is executed.

Reset of service interval

After each service, the service indicator must be reset to ensure proper functionality. It is recommended to seek the assistance of a workshop.

If service is executed by yourself, operate as following:

- switch off ignition



- press and hold **SET / CLR**

- switch on ignition, the distance indication begins a countdown
- when the display indicates =0, release **SET / CLR**

The symbol  disappears.

Retrieving service information

The status of the service information can be retrieved at any time via the Info Display. Press **Check** in the vehicle settings menu. The service information is displayed for a few seconds.

Info Display ⇨ 78.

Service information ⇨ 280.

Control indicators

The control indicators described are not present in all vehicles. Depending on the equipment, the position of the control indicators may vary. When the ignition is switched on, most control indicators will illuminate briefly as a functionality test.

The control indicator colours mean:

red : danger, important reminder
yellow : warning, information, fault

green : confirmation of activation
 blue : confirmation of activation
 white : confirmation of activation
 grey : system paused, at least one system limitation has been detected

Control indicators are located in the Driver Information Centre.

Driver Information Centre ⇨ 77.

Overview

The numbers in the overview table indicate what to do, when a control indicator illuminates or flashes.

- 1 : only for information
- 2 : information and warning
- 3 : seek the assistance of a workshop
- 4 : stop engine and seek the assistance of a workshop
- 5 : have the cause of the fault remedied immediately by a workshop
- 6 : stop vehicle, do not continue the journey and seek the assistance of a workshop



1 Turn lights ⇨ 69



2 Seat belt reminder ⇨ 69



5 Airbag and belt tensioners ⇨ 70



1 Airbag deactivation ⇨ 70



4 Charging system ⇨ 70



5 Malfunction indicator light ⇨ 70



5 Service vehicle soon ⇨ 71



4 Stop engine ⇨ 71



4 System check ⇨ 71



6 Brake and clutch system ⇨ 71



1 / 5 Parking brake ⇨ 71



2 Automatic operation of electric parking break off ⇨ 72



5 Electric parking brake fault ⇨ 72



1 Parking assist ⇨ 73



2 Antilock brake system (ABS) ⇨ 72



1 Gear shifting ⇨ 72



2 Lane keep assist ⇨ 72



2 Advanced lane keep assist ⇨ 73



2 / 5 Electronic Stability Control and Traction Control system ⇨ 73



4 Engine coolant temperature high ⇨ 73



1 Preheating ⇨ 73















2 / 3 Exhaust filter ⇨ 73





1 AdBlue ⇨ 74



2 / 3 Deflation detection system ⇨ 74

	4	Engine oil pressure ↻ 74
	2	Low fuel ↻ 75
	1	Autostop ↻ 75
	1	Exterior light ↻ 75
	1	Low beam ↻ 75
	1	High beam ↻ 76
	1	High beam assist ↻ 76
	1	Front fog lights ↻ 76
	1	Rear fog light ↻ 76
	1	Rain sensor ↻ 76
	2 / 3	Active emergency braking ↻ 76
	2 / 3	Traffic sign assistant ↻ 76
	2	Door open ↻ 77
	5	Service vehicle soon ↻ 71
	2	Charging cable connected ↻ 75

READY	1	Vehicle ready ↻ 75
	2	Reduced engine power ↻ 75
	6	High voltage battery temperature high ↻ 75
	3	Pedestrian safety alert fault ↻ 76

Turn lights

↻↻ illuminates or flashes green.

Illuminates briefly

The parking lights are switched on.

Flashes

Turn lights or the hazard warning flashers are activated.

Rapid flashing: failure of a turn light or associated fuse.

Bulb replacement ↻ 258.

Turn lights ↻ 89.

Seat belt reminder



Seat belt reminder on all seats

 illuminates or flashes red in the instrument cluster together with the indication in the overhead console for each seat belt.



- When the ignition is switched on,  in the instrument cluster and the symbol for the respective seat in the overhead console come on, if a seat belt is not

fastened. The front passenger seat is only displayed when occupied.

- After driving off,  in the instrument cluster and the symbol for the respective seat in the overhead console flash for a certain time together with a chime. After a certain time of driving  illuminates constantly until the seat belt of the respective seat has been fastened or if any passenger has unfastened the seat belt.

Seat belts ⇨ 30.

Airbag and belt tensioners

 illuminates red.

When the ignition is switched on, the control indicator illuminates for some seconds. If it does not illuminate, does not extinguish after some seconds or illuminates whilst driving, there is a fault in the airbag system. Seek the assistance of a workshop. The airbags and belt pretensioners may fail to trigger in the event of an accident.

Deployment of the belt pretensioners or airbags is indicated by continuous illumination of .

Warning

Have the cause of the fault remedied immediately by a workshop.

Belt pretensioners ⇨ 30.

Airbag system ⇨ 33.

Airbag deactivation



 illuminates yellow.

The front passenger airbag is activated.

 illuminates yellow.

The front passenger airbag is deactivated.

Airbag deactivation ⇨ 38.

Charging system

 illuminates red.

Illuminates when the ignition is switched on and extinguishes shortly after the engine starts.

Illuminates when the engine is running

Stop, switch off engine. Vehicle battery is not charging. Engine cooling may be interrupted. The brake servo unit may cease to be effective. Seek the assistance of a workshop.

Malfunction indicator light

 illuminates or flashes yellow.

Illuminates when the ignition is switched on and extinguishes shortly after the engine starts.



Illuminates when the engine is running

Fault in the emission control system. The permitted emission limits may be exceeded. Seek the assistance of a workshop immediately.

Flashes when the engine is running

Fault that could lead to catalytic converter damage. Ease up on the accelerator until the flashing stops. Seek the assistance of a workshop immediately.

Service vehicle soon

 /  illuminates yellow.

Illuminates briefly when the ignition is switched on.

May illuminate together with other control indicators and a corresponding message in the Driver Information Centre.

Seek the assistance of a workshop immediately.



Illuminates permanently when the ignition is switched on.

A fault of the electric engine or the high voltage battery has been detected.

Seek the assistance of a workshop immediately.

Stop engine

illuminates red.

Illuminates briefly when the ignition is switched on.

Illuminates together with other control indicators, accompanied by a warning chime and a corresponding message in the Driver Information Centre.

Stop engine immediately and seek the assistance of a workshop.

System check

illuminates yellow or red.

Illuminates yellow

A minor engine fault has been detected.

Illuminates red

A major engine fault has been detected.

Stop engine as soon as possible and seek the assistance of a workshop.

Brake and clutch system

illuminates red.

The brake and clutch fluid level is too low.

Warning

Stop. Do not continue your journey. Consult a workshop.

Brake fluid ↻ 254.

Parking brake

illuminates or flashes red.

Illuminates

Parking brake is applied ⇨ 183.

Flashes

Electric parking brake is not applied automatically. The application or the release are faulty.

⚠ Warning

Have the cause of the fault remedied immediately by a workshop.

Electric parking brake fault

(P)! illuminates yellow.

Illuminates

Electric parking brake has a fault ⇨ 183.

⚠ Warning

Have the cause of the fault remedied immediately by a workshop.

Automatic operation of electric parking brake off

 illuminates yellow.

Illuminates

Automatic operation is deactivated or faulty. In the event of a fault,  illuminates together with other control indicators or it is accompanied by a corresponding message in the Driver Information Centre.

Activate automatic operation again or have the cause remedied by a workshop in the event of a fault.

Automatic operation ⇨ 183.

Antilock brake system (ABS)

 illuminates yellow.

Illuminates for a few seconds after the ignition is switched on. The system is ready for operation when the control indicator extinguishes.

If the control indicator does not extinguish after a few seconds, or if it illuminates while driving, there is a

fault in the ABS. The brake system remains operational but without ABS regulation.

Antilock brake system ⇨ 182.

Gear shifting

▲ or ▼ with the number of a higher or lower gear is indicated, when upshifting or downshifting is recommended for fuel saving reasons.

On vehicles with automatic transmission, the system is only active in manual mode.

Automatic transmission ⇨ 177.

Lane keep assist

 illuminates or flashes yellow.

Illuminates yellow

A fault has been detected.

Flashes yellow

The system is correcting the unintended lane change.

Lane keep assist ⇨ 224.

Advanced lane keep assist

 illuminates grey, green or yellow.

Illuminates grey

The system is paused. At least one system limitation has been detected.

Illuminates green

The system is active and ready to operate.

Illuminates yellow

The system has a fault.

Advanced lane keep assist ⇨ 226.

Parking assist

 flashes yellow as soon as an obstacle gets closer to the vehicle.

Parking assist ⇨ 205



Electronic Stability Control and Traction Control system

 illuminates or flashes yellow.

Illuminates

A fault in the system is present. Continued driving is possible. Driving stability, however, may deteriorate depending on road surface conditions.

Have the cause of the fault remedied by a workshop.

After reconnecting the vehicle battery, (e.g. after maintenance work),  is illuminated for several seconds. After this time period,  extinguishes. This is a normal procedure, the vehicle does not need any assistance.

Flashes

The system is actively engaged. Engine output may be reduced and the vehicle may be braked automatically to a small degree.

Electronic Stability Control and Traction Control system ⇨ 186.

Engine coolant temperature

 illuminates red.

Illuminates red when the engine is running

Stop, switch off engine.

Caution

Coolant temperature too high.

Check coolant level immediately
⇨ 253.

If there is sufficient coolant, consult a workshop.

Preheating

 illuminates yellow.

Preheating of diesel engine is activated. Only activates when outside temperature is low. Start the engine when control indicator extinguishes.

Starting the engine ⇨ 166.

Exhaust filter

 illuminates yellow.

The exhaust filter requires cleaning.

Continue driving until the control indicator extinguishes.

Illuminates temporarily

Start of saturation of the exhaust filter.
Start cleaning process as soon as possible by driving at a vehicle speed of at least 40 mph.

Illuminates constantly

Indication of a low additive level. Seek the assistance of a workshop.

Exhaust filter ↻ 171.

AdBlue

 flashes or illuminates yellow.

Illuminates yellow

The remaining driving range is between 500 miles and 1500 miles.

Flashes yellow

The remaining driving range is between 0 and 500 miles.

AdBlue level is low. Refill AdBlue soon to avoid prevention of the engine start.

AdBlue ↻ 172.

Deflation detection system

 illuminates or flashes yellow.

Illuminates

Tyre pressure loss in one or more wheels. Stop immediately and check tyre pressure.

Flashes

Fault in system. Consult a workshop.
Deflation detection system ↻ 263.

Engine oil pressure

 illuminates red.

Illuminates when the ignition is switched on and extinguishes shortly after the engine starts.

Illuminates when the engine is running

Caution

Engine lubrication may be interrupted. This may result in damage to the engine and / or locking of the drive wheels.

1. Select neutral gear.
2. Move out of the flow of traffic as quickly as possible without impeding other vehicles.
3. Switch off ignition.

Warning

When the engine is off, considerably more force is needed to brake and steer. During an Autostop the brake servo unit will still be operational.

Do not remove key until vehicle is stationary, otherwise the steering wheel lock could engage unexpectedly.

Keep engine turned off and let the vehicle be towed to a workshop.

Low fuel

 illuminates yellow.

Level in fuel tank is too low.

Refuelling ⇨ 241.

Bleeding the diesel fuel system
⇨ 257.

Charging cable connected

 illuminates red.

The vehicle plug of the charging cable is still connected to the charge port. The vehicle cannot be started.

Disconnect the vehicle plug from the charge port and close the charge port flap.

Charging ⇨ 232.

Vehicle ready

READY illuminates green. The vehicle is ready to be driven.

Reduced engine power

 illuminates yellow.

The charging level of the high voltage battery is low. Only reduced engine power is available.

High voltage battery temperature high

 illuminates red.

Illuminates briefly when the ignition is switched on.

Illuminates together with other control indicators, accompanied by a warning chime and a corresponding message in the Driver Information Centre.

Stop engine immediately and evacuate the vehicle.

Autostop

 illuminates or flashes green.

Illuminates green

Engine is in an Autostop.

Flashes green

Autostop is temporarily unavailable, or Autostop mode is invoked automatically.

Stop-start system ⇨ 167.

Exterior light

 illuminates green.

The exterior lights are on ⇨ 84.

Low beam

 illuminates green.

Illuminated when low beam is on.

High beam

 illuminates blue.

Illuminates when high beam is on or during headlight flash ⇨ 85.

High beam assist

 illuminates green.

The high beam assist is activated ⇨ 85.

LED headlights

 illuminates and a warning message is displayed in the Driver Information Centre.

Seek the assistance of a workshop.

Front fog lights

 illuminates green.

The front fog lights are on ⇨ 89.

Rear fog light

 illuminates yellow.

The rear fog light is on ⇨ 90.

Rain sensor

 illuminates green.

Illuminated when rain sensor position on wiper lever is selected.

Windscreen wiper and washer ⇨ 58.

Pedestrian safety alert fault

 illuminates yellow.

The pedestrian safety alert is not working.

Active emergency braking

 illuminates or flashes yellow.

Illuminates

The system has been deactivated or a fault has been detected.

Additionally, a warning message is displayed in the Driver Information Centre.

Check the reason of the deactivation ⇨ 200 and in case of a system fault, seek the assistance of a workshop.

Notice

 also illuminates if the seat belts of the front passengers are not fastened. In this case, active emergency braking is deactivated.

Flashes

The system is actively engaged and brakes automatically the vehicle.

Active emergency braking ⇨ 200.

Forward collision alert ⇨ 198.

Front pedestrian protection ⇨ 204.

Traffic sign assistant

 illuminates for a few seconds or permanently.

Illuminates for a few seconds

If the vehicle exceeds the speed limit provided by the traffic sign assistant, the speed limit displayed in the Driver Information Centre flashes and an audible signal is given. If flashing and audible signal are deactivated,  illuminates for a few seconds.

Illuminates permanently

If the traffic sign assistant has a failure,  illuminates permanently. Consult a workshop.

Traffic sign assistant  220.

Door open

 illuminates red.

A door or the tailgate is open.

Displays

Driver Information Centre

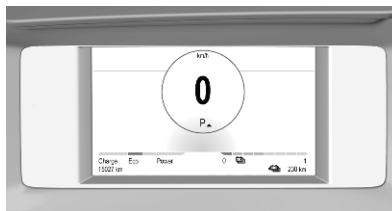

Depending on version, two variants are available.

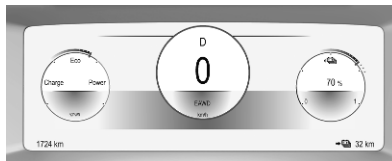

In addition to warning lights, gauges and indicators, the following information is available:

- trip odometer
- gear shift indication
- service information
- vehicle and warning messages

- driver assistance systems
- pop-up messages
- infotainment information

Selecting menus and functions

The menus and functions can be selected via the buttons on the indicator lever.

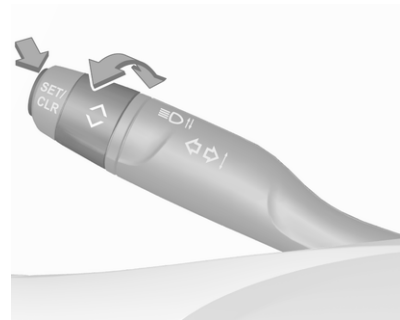

Turn the adjuster wheel to select a view of the Driver Information Centre. Different views are available for driving and navigation information. Also a personalised view is selectable.

Press **SET / CLR** to confirm or reset a function.

Vehicle and service messages are popped up in the Driver Information Centre, if required. Scroll messages by turning the adjuster wheel. Confirm messages by pressing **SET / CLR**.

Vehicle messages ⇨ 80.

Personalised view

Personalised views can be selected by turning the adjuster wheel.

The personalised views can be adjusted in the settings menu in the Info Display.

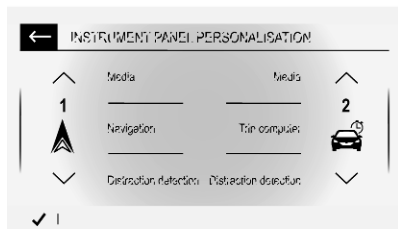

Choose the content, e.g. the navigation map or current trip information, and confirm the settings.

Info Display



The illustrations show different variants of the infotainment system.



The Info Display can indicate:

- time ⇨ 61
- outside temperature ⇨ 60
- date ⇨ 61
- infotainment system ⇨ 93
- indication of rear view camera ⇨ 217
- navigation ⇨ 114
- vehicle and system messages ⇨ 80
- settings for vehicle personalisation ⇨ 81
- AdBlue range ⇨ 172

Selecting menus and settings

There are three options to operate the display:

- via buttons next to the display
- by touching the touchscreen with the finger
- via speech recognition

Notice

Some menu entries are only available when ignition is switched on, when combustion engine is running or when electric engine is ready or until a specific speed.

Button and touch operation



Press  to switch on the display.

Press  to select system settings (units, language, time and date).

Press  to select vehicle settings or driving functions.

Touch required menu display icon or a function with the finger.

Confirm a required function or selection by touching.

Touch  or  on the display to exit a menu without changing a setting.

Infotainment system ⇨ 93.

Flow

This menu displays the current energy flow within the electric system.

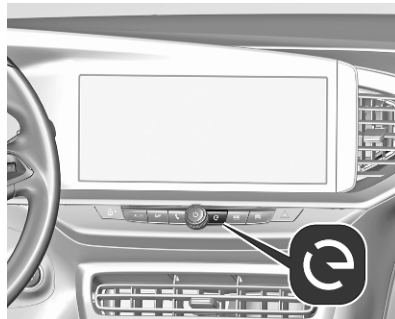

1. Press .
2. Select **Flow**.

Different colours show the energy flow.

- green: electric engine operating
- blue: regenerating energy

Average consumption

This menu displays the average power consumption during the current trip.

- green: electric energy consumed
- blue: electric energy generated from the braking and deceleration phases of the vehicle used to recharge the battery

The current trip is subdivided into time steps. For each time step, the average consumption is displayed. The time steps can be modified.



1. Press .
2. Select **Statistics**.
3. Press **+** and **-** to modify the time steps.

Vehicle messages

Messages are indicated in the Driver Information Centre, in some cases together with a warning chime.



Press **SET / CLR** to confirm a message.

Vehicle and service messages

The vehicle messages are displayed as text. Follow the instructions given in the messages.

Messages in the Info Display

Some important messages may appear additionally in the Info Display. Some messages only pop-up for a few seconds.

Warning chimes

The warning chime regarding not fastened seat belts has priority over any other warning chime.

Whenever a warning chime sounds, pay attention to the messages displayed and the warning lights in the Driver Information Centre.

When a failure is detected in the sound module  appears in the Driver Information Centre, accompanied by a display message. No warning chime will sound, also not for the driver assistance systems.

When starting the engine or whilst driving

A warning chime will sound when

- a seat belt is not fastened
- a door or the tailgate is not fully closed

- a certain speed is exceeded with parking brake applied
- cruise control deactivates automatically
- a programmed speed or speed limit is exceeded
- a warning message appears in the Driver Information Centre
- the electronic key is not in the passenger compartment
- the parking assist detects an object
- an unintended lane change occurs
- hands-off driving is recognised
- drowsiness of the driver is recognised
- a vehicle directly ahead is approached too quickly
- the exhaust filter has reached the maximum filling level

If several warnings appear at the same time, only one warning chime will sound.

When the vehicle is parked and / or the driver's door is opened

A warning chime will sound when

- the exterior lights are on
- the key is in the ignition switch

During an Autostop

- If the driver's door is opened.
- If any condition for a restart of the engine is not fulfilled.

Vehicle personalisation

The vehicle's behaviour can be personalised by changing the settings in the Info Display.

Some functions are only displayed or active when the engine is running.



The illustrations show different variants of the infotainment system.



Touch  to display the vehicle personalisation menu.

Lighting, comfort and safety settings are adjustable.

Telematics services

Vauxhall Connect

Vauxhall Connect comprises multiple connected services accessible via app, online or within the vehicle.

Notice

Full functionality of Vauxhall Connect is subject to registration and proper activation.

Connected services may include live navigation such as online traffic information and vehicle status and information such as maintenance alerts.

Services accessible within the vehicle also include emergency call and breakdown call. These functions are automatically activated. Terms and conditions apply.

Emergency call  82.

Breakdown call

Pressing the  button in the overhead console for more than two seconds connects to a roadside assistance service provider.

For information about coverage and scope of services of the roadside assistance, please refer to the information provided by the Vauxhall Retailer with the order form.

Privacy settings

Privacy settings of Vauxhall Connect can be configured. This will impact the set of data being sent, e.g., in case a breakdown call is triggered. The emergency call function and the traffic sign assistant will not be impacted.

Depending on version, the privacy settings can be changed by simultaneously pressing  and **SOS** in the overhead console or via the system settings menu in the Info Display.

Emergency call

Notice

In order to be available and operational, the system requires functioning vehicle electrics, mobile service and GPS or GLONASS

satellite link. Depending on equipment, a backup battery is used.

Notice

The service is only available for markets where it is legally required. Furthermore, it depends on the availability of the emergency centres and the infrastructure in the country.

Status LED in the overhead console

Illuminates green and red and extinguishes after a short time, when the ignition is switched on: the system works properly.

Illuminates red: fault in the system. Contact a workshop.

Flashes red: backup battery needs replacement. Contact a workshop.

Emergency call

The emergency call function will establish a connection to the nearest public safety answering point (PSAP). A minimum set of data including vehicle and location information will be sent to the PSAP.

In case of an emergency, press the red **SOS** button in the overhead console for more than two seconds. The LED flashes green to confirm that a connection to the nearest PSAP is being established. The LED illuminates steadily as long as the call is active.

Pressing the **SOS** button immediately a second time will terminate the call. The LED switches off.

Automatic crash notification

In case of an accident with airbag deployment and without damage of needed hardware, an automatic emergency call is established and an automatic crash notification will be transmitted to the next PSAP.

Lighting

Exterior lighting	84
Light switch	84
Automatic light control	85
High beam	85
High beam assist	85
Headlight flash	86
Headlight range adjustment	86
Headlights when driving abroad	86
Daytime running lights	86
Matrix-LED headlights	87
Hazard warning flashers	88
Turn lights	89
Front fog lights	89
Rear fog light	90
Parking lights	90
Reversing lights	90
Misted light covers	90
Interior lighting	91
Instrument panel illumination control	91
Interior lights	91
Reading lights	91
Sunvisor lights	91

Lighting features	92
Entry lighting	92
Exit lighting	92
Vehicle locator lighting	92
Peripheral lighting	92
Battery discharge protection	92

Exterior lighting

Light switch



Turn light switch:

AUTO : automatic light control
switches automatically
between daytime running
light and headlight

☞☞ : sidelights

☞☞☞ : headlights

Control indicator ☞☞ ⇨ 75.

Automatic light control



When the automatic light control function is switched on, the system switches between daytime running lights and headlights automatically depending on the external lighting conditions and information given by the wiper system.

Daytime running light ↗ 86.

Automatic headlight activation

During poor lighting conditions the headlights are switched on.

Additionally, headlights are switched on if the windscreen wipers have been activated for several wipes.

Tunnel detection

When a tunnel is entered, headlights are switched on immediately.

High beam

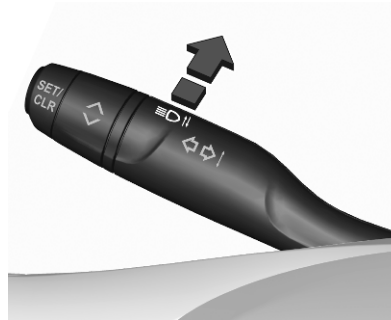

Push to switch from low to high beam.
Push again to deactivate high beam.

High beam assist

The system switches from low beam to high beam and vice versa to prevent glaring. Once activated, high beam assist remains active and switches high beam on and off depending on surrounding

conditions. The latest setting of the high beam assist will remain after the ignition is switched on again.



Glare-free high beam for Matrix-LED headlights ↗ 87.



Activation

The high beam assist can be activated via the vehicle settings menu in the Info Display.

Info Display ↗ 78.

High beam is switched on automatically in dark surroundings at a speed above 28 mph. High beam is switched off at a speed below 22 mph, but high beam assist remains active.

The green control indicator  illuminates continuously when the high beam assist is activated, the blue  illuminates when high beam is on.

Control indicator  ↗ 76,  ↗ 76.

High beam assist switches automatically to low beam when:

- Driving in urban areas.
- Camera detects heavy fog.

- Rear fog light is switched on.
- Oncoming or preceding vehicles are detected by the camera.

If there are no restrictions detected, the system switches back to high beam.

Deactivation

The system can be deactivated via the vehicle settings menu in the Info Display.

Info Display ⇨ 78.

Headlight flash

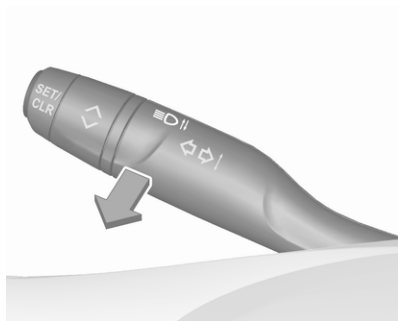

Pull to activate the headlight flash.

Headlight range adjustment



Headlight range can be adjusted manually if vehicle is not equipped with Matrix-LED headlights. Matrix-LED headlights are adjusted automatically.

To adapt headlight range manually to the vehicle load to prevent dazzling, turn thumb wheel  to required position.

ICE

- 0 : front seats occupied
- 1 : all seats occupied

- 2 : all seats occupied and load compartment laden
- 3 : driver's seat occupied and load compartment laden

BEV

- 0 : front seats occupied
- 1 : all seats occupied with or without load compartment laden
- 2 : driver's seat occupied and load compartment laden
- 3 : not used

Propulsion types ⇨ 4.

Headlights when driving abroad

When driving in countries where traffic drives on the opposite side of the road, the headlights do not have to be adjusted.

Daytime running lights

Daytime running lights increase visibility of the vehicle during daylight. Automatic light control ⇨ 85.

Matrix-LED headlights

The Matrix-LED headlight system contains a variety of particular LEDs in each headlight which enables the control of the adaptive forward lighting functions.

Light distribution and intensity of light are variably triggered depending on the lighting conditions, road type and driving situation. The vehicle adapts the headlights automatically to the situation to enable optimal light performance for the driver.

The adaptive forward lighting and the Matrix-LED headlights functions can be deactivated or activated in the vehicle personalisation menu.

Vehicle personalisation ⇨ 81.

Info Display ⇨ 78.

The glare-free high beam function of the Matrix-LED headlights are only available with light switch in position **AUTO**.

Country light

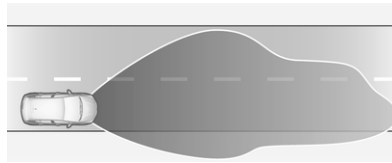

Activated automatically at a speed above 30 mph when driving in rural areas. The illumination of the current lane and the side of the road is adapted. Oncoming and preceding vehicles are not dazzled.

Town light

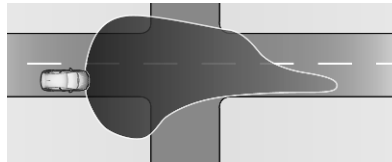

Activated automatically at a speed up to approx. 30 mph. The light is wide and symmetrical.

Cornering light

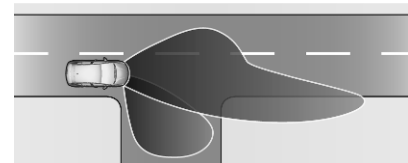

Activated at a speed of up to 25 mph when turning off. The light consists of particular LEDs which illuminate the direction of travel. These LEDs are triggered depending on the steering angle or the activation of the turn lights.

Curve light

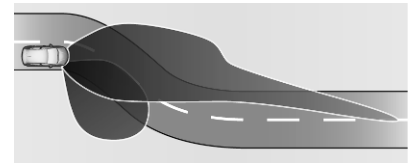

Particular LEDs, based on steering angle and speed, are additionally triggered to improve lighting in curves. This function is activated at speeds from 25 mph to 43 mph.

Glare-free high beam

⚠ Warning

The glare-free high beam function may dazzle other road users when the vehicle is driven in countries where traffic moves on the opposite side of the road. E.g. when the vehicle was designed for left hand drive traffic and it is driven in a country with right hand drive traffic.

Switch off glare-free high beam function whenever you are driving in countries mentioned above!

The system enables a glare-free high beam when driving in dark surroundings.



Each LED on right or left side is triggered or faded out particularly according to the traffic situation. This gives the best light distribution without dazzling other road users.

Glare-free high beam is switched on automatically at a speed above 28 mph. It is switched off at a speed below 22 mph, but the system remains active.

Motorway mode

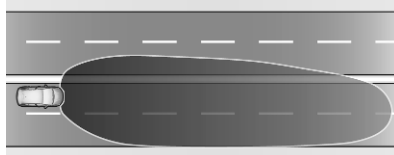

Activated automatically at a speed above 65 mph. Illumination is adapted to the higher speed driven on motorways. If there is no oncoming traffic, the visibility on the side of the vehicle is increased. When following vehicles ahead or passing, dazzling for these vehicles is reduced.

Fault in LED headlight system

When the system detects a failure in the LED headlight system, it selects a preset position to avoid dazzling of oncoming traffic. A warning is displayed in the Driver Information Centre.

After reconnecting the vehicle battery, the system needs a recalibration by driving a short distance.

Hazard warning flashers

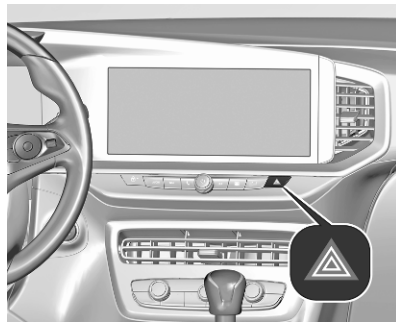

Operated by pressing ⚠.

When braking in an emergency, the hazard warning flashers are switched on automatically, depending on the force of deceleration. They are switched off automatically, as soon as the vehicle is accelerated again.

Turn lights

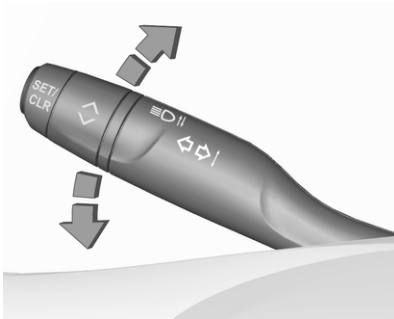

up : right turn lights
down : left turn lights

A resistance point can be felt when moving the indicator lever.

Constant flashing is activated when the indicator lever is being moved beyond the resistance point. It is

deactivated when the steering wheel is moved in the opposite direction or indicator lever is manually moved back to its neutral position.

After 20 seconds the volume of the audible signal will increase if the speed is above 50 mph.

Activate temporary flashing by holding the indicator lever just before the resistance point. Turn lights will flash until indicator lever is being released.

To activate three flashes, tap the indicator lever briefly without passing the resistance point.

Front fog lights



Operated by pressing $\#D$.

Light switch in position **AUTO**: switching on front fog lights will switch headlights on automatically.

Rear fog light



Operated by pressing .

Light switch in position **AUTO**: switching on rear fog light will switch headlights on automatically.

Light switch in position : rear fog light can only be switched on with front fog lights.

The vehicle rear fog light is deactivated when a plug is connected to the power outlet of the trailer hitch.

Parking lights

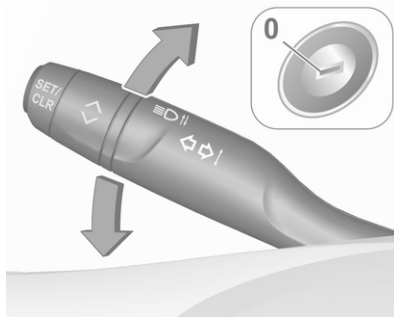

When the vehicle is parked, the parking lights on one side can be activated:

1. Switch off ignition.
2. Move the lever all the way up (right parking lights) or down (left parking lights).

Confirmed by a signal and the corresponding turn lights control indicator.

Reversing lights

The reversing light comes on when reverse gear is selected.

Misted light covers

The inside of the light housing may mist up briefly in poor, wet and cold weather conditions, in heavy rain or after washing. The mist disappears quickly by itself. To help, switch on the headlights.

Interior lighting

Instrument panel illumination control



Brightness of the following lights can be adjusted when the exterior lights are on:



- instrument panel illumination
- Info Display
- illuminated switches and operation elements

Turn thumb wheel  and hold until the desired brightness is obtained.

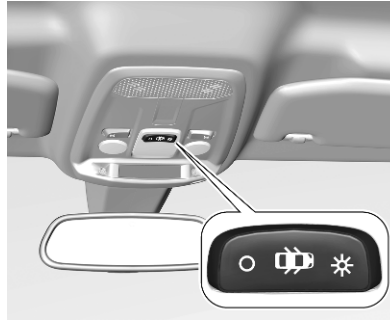
Interior lights



Operate rocker switch:

-  : automatic switching on and off
- press  : on
- press  : off

Notice

In the event of an accident with airbag deployment the courtesy lights are turned on automatically.

Reading lights

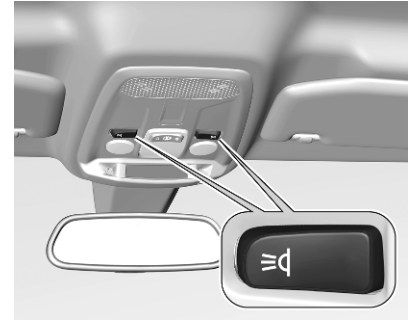

Operated by pressing .

Sunvisor lights

Illuminates when the cover is opened.

Lighting features

Entry lighting

Welcome lighting

Some or all of the following lights are switched on for a short time by unlocking the vehicle with the radio remote control:

- headlights
- interior lights

The number of activated lights depends on the surrounding light conditions.

The lighting switches off immediately when the ignition is switched on.

Starting off ⇨ 164.

This function can be activated or deactivated in the vehicle personalisation.

Vehicle personalisation ⇨ 81.

The following lights will additionally switch on when the driver's door is opened:

- illumination of some switches
- Driver Information Centre
- door pocket lights

Exit lighting

The following lights are switched on when the ignition is switched off:

- headlights
- interior lights
- centre console lighting

They will switch off automatically after a delay. This function works only in the dark.

Vehicle locator lighting

This function allows to locate the vehicle, e.g., in weak lighting conditions using the remote control. The headlights come on and the turn lights flash for 10 seconds.

Press  on the remote control.

Peripheral lighting

Peripheral lighting allows you to switch on the position lights, low beam and number plate lighting using the remote control.

Press  on the remote control to switch on peripheral lighting.

Press  a second time to switch off peripheral lighting.

Battery discharge protection

To prevent discharge of the vehicle battery when the ignition is switched off, some interior lights are switched off automatically after some time.

Infotainment system

Multimedia Navi Pro	93
Audio	108
External devices	111
Navigation	114
Speech recognition	125
Phone	127
Multimedia	132
Audio	141
External devices	143
Speech recognition	146
Phone	148

Multimedia Navi Pro

Introduction

Important information on operation and traffic safety

⚠ Warning

Drive safely at all times. Only operate the Infotainment system if the traffic conditions allow a safe usage.

In the interest of safety, it might be appropriate to stop the vehicle before operating the Infotainment system (e.g. for entries of addresses).

⚠ Warning

The usage of the navigation system does not release the driver from the responsibility for a correct, vigilant attitude in road traffic. Always follow the applicable traffic rules.

⚠ Warning

In some areas one-way streets and other roads and entrances (e.g. pedestrian zones) that you are not allowed to turn into are not marked on the map. In such areas the Infotainment system may issue a warning that must be accepted. Here you must pay particular attention to one-way streets, roads and entrances that you are not allowed to drive into.

Radio reception

Radio reception may be disrupted by static, noise, distortion or loss of reception due to:

- changes in distance from the transmitter
- multi-path reception due to reflection
- shadowing

Theft-deterrent feature

The Infotainment system is equipped with an electronic security system for the purpose of theft deterrence.

The Infotainment system therefore functions only in your vehicle and is worthless to a thief.

Multimedia Navi Pro

Control panel – Multimedia Navi Pro

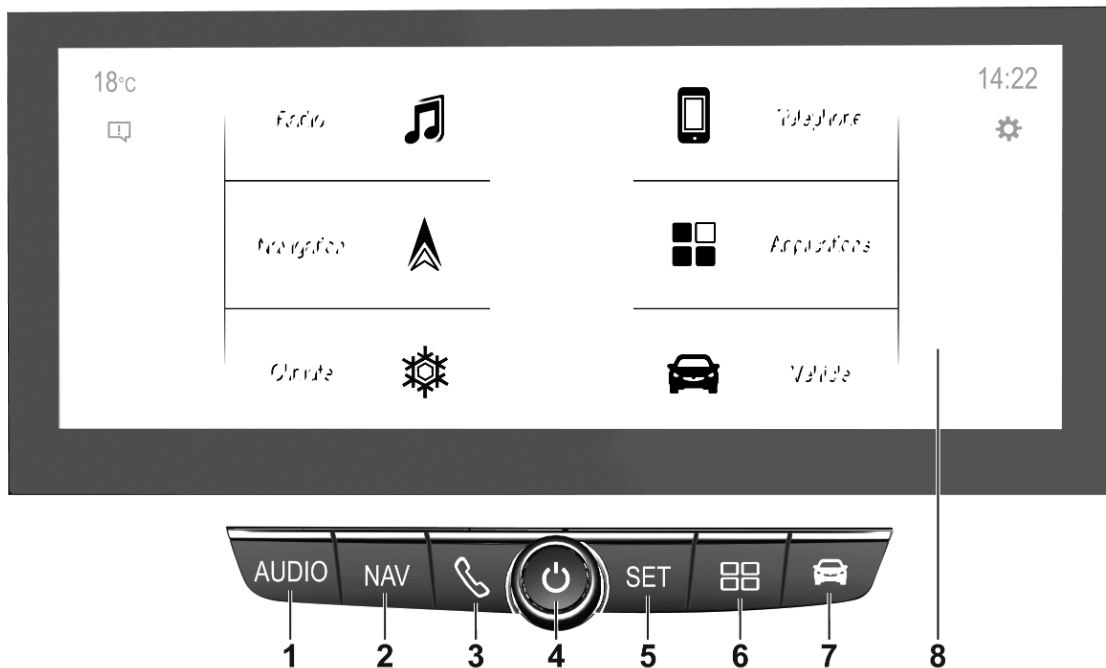

1 AUDIO

Open audio menu:

Radio 108

External devices (USB,
Bluetooth) 111

2 NAV

Display embedded
navigation map 114

3 

Open phone menu 127

Display phone projection
screen when phone
projection is active 111

4 

If switched off: switch
power on / off

If switched on: mute system

Turn: adjust volume

5 SET / 

Open settings menu

or open charging settings
(BEV) 78

6 

Open apps menu 111

7 

Open vehicle settings menu . 81





8 Info Display

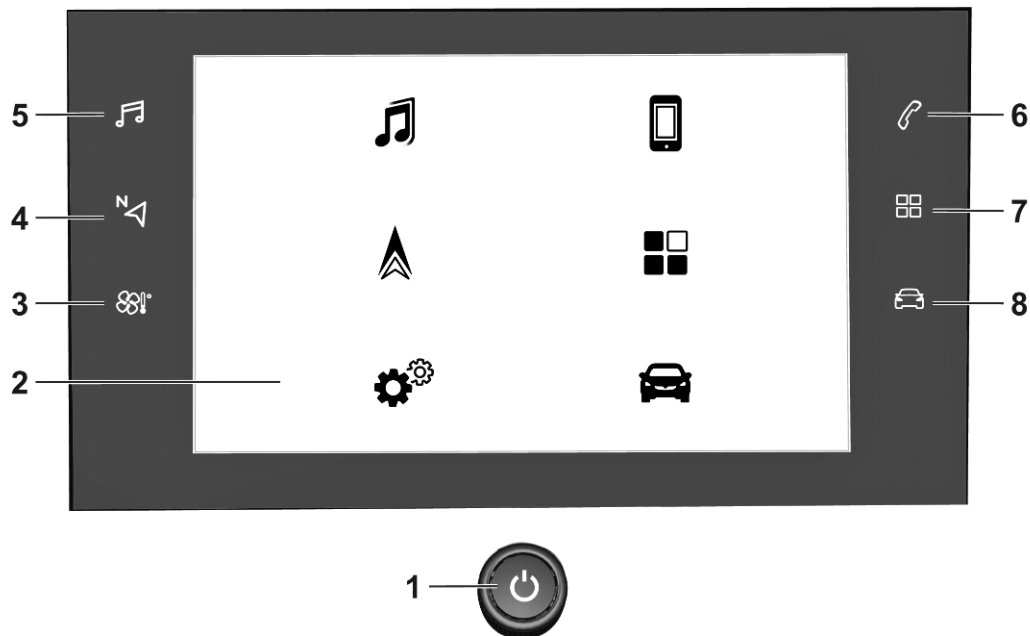

Home menu will be
displayed by a 3-finger
touch on screen

Multimedia Navi Pro

Control panel – Multimedia Navi



- 1 
 If switched off: switch power on / off
 If switched on: mute system
 Turn: adjust volume
- 2 Info Display
 Home menu will be displayed by a 3-finger touch on screen
- 3 
 Open climate menu if available
- 4 
 Display embedded navigation map 114
- 5 
 Open audio menu:
 Radio 108
 External devices (USB, Bluetooth) 111

- 6 
 Open phone menu 127
 Display phone projection screen when phone projection is active 111
- 7 
 Open apps menu 111
- 8 
 Open vehicle settings menu . 81

Steering wheel controls

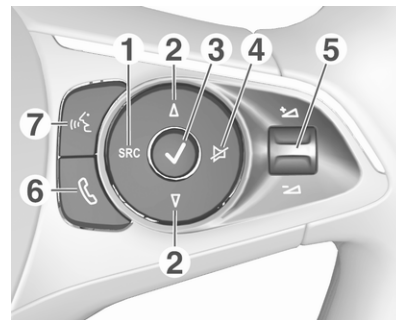

- 1 **SRC (Source)**
 Select audio source, confirm selection with ✓
- 2 
 Long press: mute system
 Select next / previous preset radio station when radio active 108
 or select next / previous track / picture when external devices active 111

or select next / previous entry in station list, media list, call / contacts list when operation started via steering wheel controls

Confirm selection with ✓



3 ✓

Confirm selected item

or open station list, media list

4 

Activate / deactivate mute function

5  / 

Turn upwards / downwards: increase / decrease volume

6 

Short press: accept incoming call

Long press: reject incoming call, hang up call .. 127

or open call / contacts list ... 127

If phone call active: open call in progress menu

7 

Short press: activate embedded speech recognition

Long press: activate speech recognition in Apple CarPlay™ or Android™ Auto if phone connected via USB port 125

Control elements

The Infotainment system is operated via function buttons, a touch screen and menus that are shown on the display.

Inputs are made optionally via:

- the control panel on the Infotainment system
- the touchscreen
- the steering wheel controls
- the speech recognition  125

Switching the Infotainment system on or off

Press . After switching on, the last selected Infotainment source becomes active.

Notice

Some functions of the Infotainment system are only available if ignition is switched on or engine is running.

Automatic switch-off

If the Infotainment system has been switched on pressing  while the ignition is switched off, it will switch off again automatically when the Eco mode becomes active.

Setting the volume

Turn . The current setting is shown on the display.

When the Infotainment system is switched on, the last selected volume is set.

Speed compensated volume

When the speed compensated volume is activated, the volume is adapted automatically to make up for the road and wind noise as you drive.

Mute

Press  to mute the Infotainment system.

To cancel the mute function, press  again. The last selected volume is set again.

Modes of operation

Audio-Media

Press **AUDIO** /  to display the main menu of the last selected audio mode.

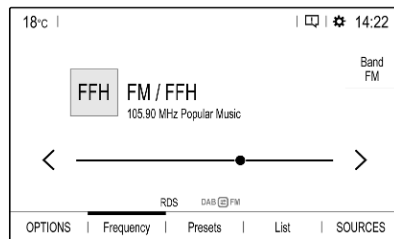

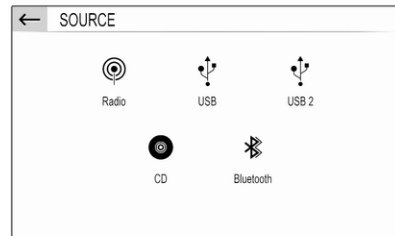

Changing the media source

Select **SOURCES** to display the menu for media source selection.



Select the desired media source.

For a detailed description of:

- Radio functions  108
- External devices  111

Navigation

Press **NAV** /  to display the navigation map showing the area around the current location.

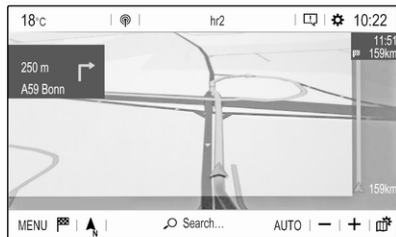

For a detailed description of basic functions of the navigation system ↪ 114.

Navigation menu

Select **MENU** to display the navigation menu.

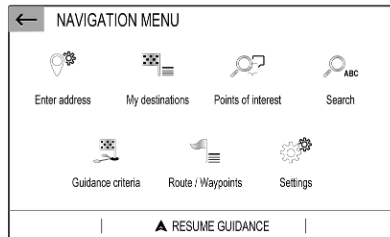

The navigation menu serves as central entry point for:

- Address search and input
- Defining trips with several waypoints
- Defining criteria for route guidance
- Cancelling and resuming route guidance

For a detailed description of basic functions of the navigation system ↪ 114.

Phone

Before the phone function can be used, a connection has to be established between the Infotainment system and the mobile phone.

For a detailed description of preparing and establishing a Bluetooth connection between the Infotainment system and a mobile phone ↪ 127.

If the mobile phone is connected, press  to display the main menu of the phone function.





For a detailed description of mobile phone operation via the Infotainment system ↪ 127.

Network and connected services

Press  and then select **OPTIONS** to display the Bluetooth, network and connected services settings.

To connect the vehicle to a Wi-Fi network, touch . A list of all available Wi-Fi networks is displayed. It is also possible to share the Wi-Fi connection for other devices.

To update the service and connection status, go to the menu for connected services  and touch .

To use the connected services, make sure that data sharing and the vehicle position are activated in the privacy menu in the **System settings**.

Apps

To show specific apps of your smartphone on the display of the Infotainment system, connect your smartphone.

Press  to display the main menu of the apps mode.

Touch **Apple CarPlay** or **Android Auto**. A menu with different selectable apps is displayed.

For a detailed description ⇨ 111.

Settings

Press **SET** /  and then select **Audio settings** to display the respective menu.

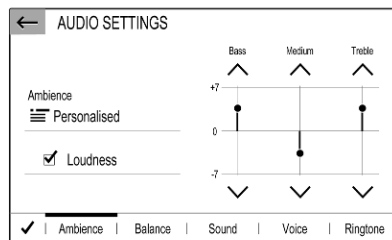

Press **SET** /  and then **OPTIONS** to display a menu for various system-related settings.

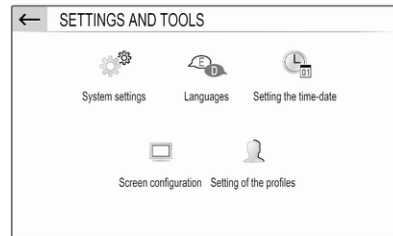

Vehicle settings

Select  to open a menu for various vehicle-related settings.

Vehicle personalisation ⇨ 81.

Menu operation

The display of the Infotainment system has a touch-sensitive surface that allows direct interaction with the displayed menu controls.

Caution



Do not use pointed or hard items like ballpoint pens, pencils or similar for touch screen operation.

Selecting or activating a screen button or menu item



Touch a screen button or menu item.

Notice

Most icons displayed in a menu, like  or  in the illustrated example, serve as screen buttons that initiate certain actions if you touch them.

The corresponding system function is activated, a message is shown, or a submenu with further options is displayed.

← and ✓ / OK screen buttons

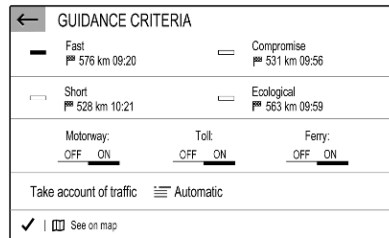

When operating the menus, touch  in the respective submenu to return to the next higher menu level.

When no  screen button is displayed, you are on the top level of the respective menu.

After selecting menu items or performing settings in a menu, touch  / OK to confirm your settings. Otherwise all performed selections or settings will be lost.

Shortcuts to important menus

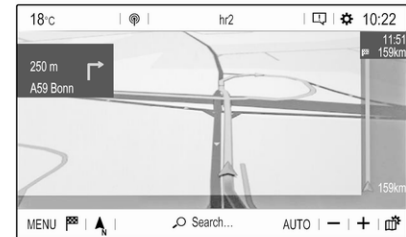

The texts and icons displayed in the top bar, of e.g. the navigation main menu, serve as shortcuts to some important menus. For example, touch the station name to open the station list menu.

Scrolling a list

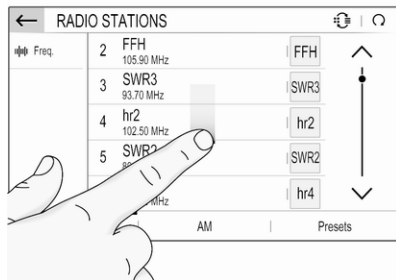

If there are more items available than presentable on the screen, the list must be scrolled.

To scroll through a list of menu items, you may optionally:

- Place your finger anywhere on the screen and move it upwards or downwards.

Notice

Constant pressure must be applied and the finger must be moved at a constant speed.

- Touch \wedge or \vee at the top or bottom of the scroll bar.

- Touch anywhere on the guiding line of the scroll bar.
- Move the slider of the scroll bar up and down with your finger.

Updating a list

Touch \odot to manually update, e.g., station lists, contacts lists or destination lists.

Input fields and keyboards

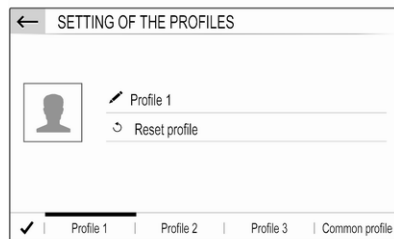

Input fields are indicated by \pencil .

Touch the input field to open a keyboard for text or number input.

Depending on the application or function currently active, different keyboards are displayed.

Keyboards for text input

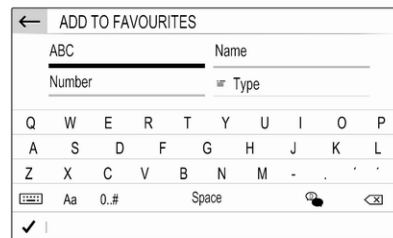

Keyboards for text input may contain several input fields. To enable a field for text input, touch it.

To enter a character, touch the respective screen button. The character is entered upon release.

Touch and hold a letter screen button to display associated letters in a letter pop-up menu. Release and then select the desired letter.

To switch to the symbol keyboard, touch **0..#**.

To switch back to the letter keyboard or to switch between capital and small letters, touch **Aa**.

To switch the letter keyboard between normal order and alphabetical order, touch .

To delete the most recently entered character or symbol, touch .

To delete a character or symbol at any point of your input: touch at the desired point to place a blinking cursor, then touch .

Audio settings

Press **SET** / , select **Audio settings** and then select the **Ambience** tab.

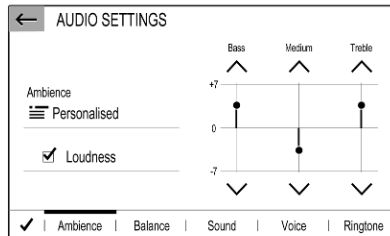

Several predefined settings are available to optimise the tone for a specific style of music (e.g. **Pop-Rock** or **Classical**).

To adjust the tone individually, select **User** or **Personalised**. Change the settings as desired and then confirm your settings.

Notice

If you change the settings of a predefined setting, e.g. **Pop-Rock**, this settings will be applied to the **User** or **Personalised** setting.

Activating the **Loudness** function may optimise the tone at low volume levels.

Balance and fader

Select the **Balance** tab.

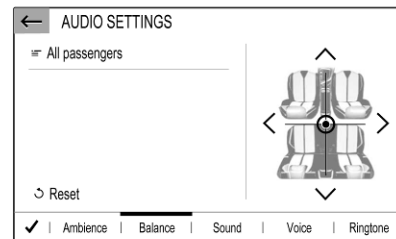

Several predefined settings are available to adjust the volume distribution inside the vehicle (e.g. **All passengers** or **Front only**).

To change the current setting, e.g. **All passengers**, select that setting and then select the desired new setting from the displayed list.

You may individually adjust the predefined settings.

To define the point in the passenger compartment where the volume is at its highest level, move the cursor in the illustration on the right side of the screen to the desired point.

To return to the default factory settings, select ↺.

Volume settings

Press **SET** / ⚙️, select **Audio settings** and then select the **Sound** tab.

Audible touch feedback

If the audible touch feedback function is activated, each touch of a screen button or menu item is indicated by a beeping sound.

To adjust the touch beep volume, activate **Touch tones** and then adjust the setting.

Speed compensated volume

Activate or deactivate **Volume linked to speed**.

If activated, the volume of the Infotainment system is adapted automatically to make up for the road and wind noise as you drive.

Speech output

Select the **Voice** tab.

Adjust the volume for all speech outputs of the system, e.g. traffic announcements, navigation messages etc.

Ringtone

Select the **Ringtone** tab.

Adjust the ringtone volume of incoming calls.

System settings

Press **SET** / ⚙️ and then select **OPTIONS**.

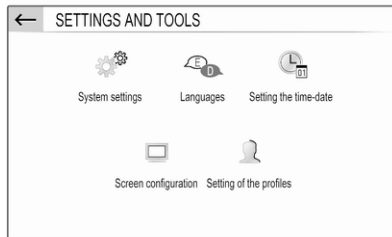

Configuring the system

Select **System settings** to perform some basic system configurations, e.g.:

- Adjust the display of units for temperature or fuel consumption.
- Reset the system configuration to factory defaults.
- Update the installed software version.
- Adjust the privacy settings for data sharing and vehicle position.

Changing display language

To adjust the language for the menu texts, select **Languages** and then select the desired language.

Notice

If the selected display language is supported by the embedded speech recognition, the language of the speech recognition will be changed accordingly; if not, embedded speech recognition will be not available.

Adjusting time and date

Select **Setting the time-date**.

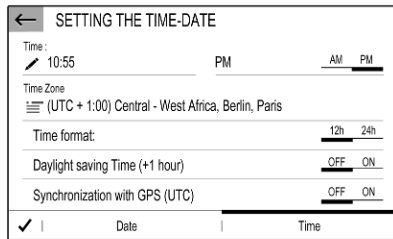

Changing time and date formats

To change the time and date formats, select the respective tabs and then select the desired formats.

Setting time and date

By default the displayed time and date is automatically adjusted by the system.

To manually adjust the displayed time and date:

Select the **Time** tab.

Set **Synchronization with GPS (UTC)** to **OFF** and then select the **Time** field to set the desired time.

Select the **Date** tab and then select the **Date:** field to set the desired date.

Adjusting the screen

Select **Screen configuration**.

Text scroll function

Select the **Animation** tab.

If long texts on the screen should be scrolled automatically, activate **Automatic scrolling**.

If **Automatic scrolling** is deactivated, long texts are truncated.

Adjusting the brightness

Select **Brightness** and set the brightness of the screen to the desired level.

Storing your personal settings

Select **Setting of the profiles**.

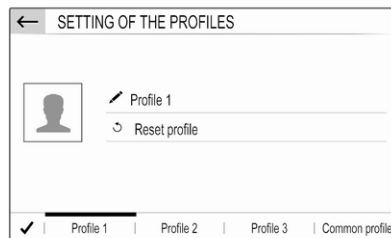

You can store a multitude of settings in a personal profile. For example, all current tone settings, all radio presets, one phone book, the map settings and your preferred addresses.

In case you share the vehicle with other people, this enables you to restore your personal settings from your profile at any time.

A maximum of three personal profiles may be stored.

Additionally, a **Common profile** is available. All settings done at any time are automatically stored in that profile. If no personal profile is activated, the **Common profile** is active.

Storing your personal profile

After performing all your personal settings:

Select one of the personal profile tabs.

Select the input field  and enter the desired name of your personal profile.

If you want to add a photo to the profile:

Connect a USB device with the desired photo stored on it to the USB port ↗ 111, touch the photo frame and then select the desired photo.

Confirm your selection to download the selected photo to the system.

Finally, confirm your inputs to store them in your personal profile.

Activating your personal profile

Press  and then select the tab with the name of your personal profile.

Activating the Common profile

If a personal profile is currently active:

Press  and then select **Deactivate profile**.

Resetting a personal profile

You can at any time reset a personal profile to restore the default factory settings on that profile.

Select the respective profile and then select **Reset profile**.

Resetting the Common profile

You can at any time reset the **Common profile** to restore the default factory settings on that profile.

Select **Common profile** and then select **Reset the common profile**.

Audio

Activating the radio

Press **AUDIO** / . The audio main menu last selected is displayed.

If the radio main menu is not active, select **SOURCES** and then select **Radio**.

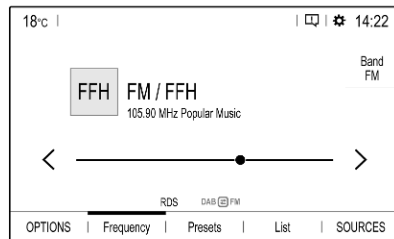

The station last played will be received.

Selecting a waveband

Repeatedly select **Band** to toggle between the different wavebands.

Searching for stations

Automatic station search

Briefly touch < or > to play the previous or next receivable station.

Manual station search

Press and hold < or >. Release when the required frequency has almost been reached.

A search is made for the next station that can be received and it is played automatically.

Station tuning

If you exactly know the reception frequency of a radio station, you may enter that frequency manually.

Select **OPTIONS**, select **Radio stations** and then select the desired waveband.

Select **Freq.**, enter the reception frequency and confirm your input.

If a station is receivable on that frequency, the respective station is played.

Station lists

In the station lists, all receivable radio stations within the current reception area are available for selection.

To display the station list of the waveband currently active, select **List**.

Select the desired station.

Update station lists

If the stations stored in the waveband-specific station list can no longer be received, the AM and the DAB station lists must be updated. The FM station list is updated automatically.

Select **OPTIONS**, select **Radio stations** and then select the desired waveband.

To start an update for the selected waveband, select .

Storing favourite stations

Up to 15 radio stations of all wavebands can be stored as favourites in the **Presets** list.

Select **Presets** to display the preset buttons.

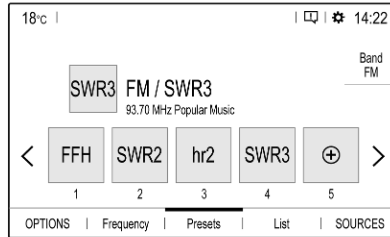

Storing the currently active station



Touch and hold the desired button for a few seconds. The respective frequency or station name is displayed on the button.

If a station is already stored on a preset button, that station will be overwritten by the new one.

Storing a station from a station list

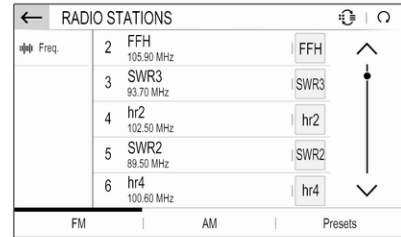
Select **OPTIONS**, select **Radio stations** and then select the desired waveband.



Briefly touch the button next to the desired station. Alternatively, select  to switch to the tiled view. Then briefly touch  on the tile of the desired station.

Select **Add to favourites** and then touch and hold for a few seconds on the list row where you want to store the station.

If a station is already stored on a list row, that station will be overwritten by the new one.

Retrieving stations

In the radio main menu select **Presets** and then briefly touch the preset button of the desired station.

RDS configuration

In the radio main menu select **OPTIONS** and then select **Radio settings** to open the menu for RDS configuration.

Activating RDS

Select **General** and then activate **Alternative frequency**.

If **Alternative frequency** is activated, **RDS** is displayed in the bottom line of the radio main menu.

Radio text

If RDS is activated, information on the radio programme currently active or the music track currently playing are displayed below the programme name.

To show or hide the information, activate or deactivate **Display radio text**.

Traffic announcements

Many RDS stations broadcast traffic news. If the traffic announcements function is activated, radio or media playback is interrupted for the duration of a traffic announcement.

Select **Announcements** and then activate or deactivate **Traffic announcement**.

If **Traffic announcement** is activated, **TA** is displayed in the bottom line of the radio main menu.

Digital audio broadcasting

Digital audio broadcasting (DAB) broadcasts radio stations digitally.

DAB stations are indicated by the programme name instead of the broadcasting frequency.

DAB Announcements

Besides their music programmes, a lot of DAB stations also broadcast announcements of various categories. If you activate some or all categories, the currently received DAB service is interrupted when an announcement of these categories is made.

In the radio main menu select **OPTIONS**, select **Radio settings** and then select **Announcements**.

Activate the desired announcement categories, e.g., **News** or **Weather**. Different announcement categories can be selected at the same time.

FM-DAB Linking

This function enables switching from an FM station to a corresponding DAB station and vice versa.

Switching from FM to DAB occurs as soon as a corresponding DAB station is available. Therefore, it is recommended to store favourite stations as DAB stations to reduce frequent switching.

Switching from DAB to FM occurs if the signal is too weak to be picked up by the receiver and the corresponding FM station is available.

Notice

After switching, the volume might be different.

Activation

Precondition is that **Alternative frequency** is activated before FM-DAB Linking can be activated.

To activate FM-DAB Linking, go to **OPTIONS ▶ Radio settings ▶ General** and select **FM-DAB Follow-up**.

The following symbol will be displayed when FM-DAB Linking is activated:



Deactivation

To deactivate FM-DAB Linking, go to **OPTIONS ▶ Radio settings ▶ General** and deselect **FM-DAB Follow-up**.

FM-DAB Linking will automatically be deactivated when **Alternative frequency** is deactivated.

External devices

A USB port is located in the centre console.

Caution

To protect the system, do not use a USB hub.

Notice

The USB ports must always be kept clean and dry.

USB ports

An MP3 player, USB device, SD card (via USB connector / adapter) or smartphone can be connected to the USB port.

The Infotainment system can play audio files or show picture files contained in USB devices.

When connected to a USB port, various functions of the devices mentioned above can be operated via the controls and menus of the Infotainment system.

Notice

Not all auxiliary devices are supported by the Infotainment system.

Connecting / disconnecting a device

Connect one of the devices mentioned above to a USB port. If required, use the appropriate connection cable. The music function starts automatically.

Notice

If a non-readable USB device is connected, a corresponding error message appears and the Infotainment system automatically switches to the previous function.

To disconnect a USB device, select another function and then remove the USB device.

Caution

Avoid disconnecting the device during playback. This may damage the device or the Infotainment system.

Bluetooth audio streaming

Streaming allows you to listen to music from your smartphone.

For a detailed description on how to establish a Bluetooth connection
 ⇨ 127.

If audio playback does not start automatically, it may be necessary to start the playback on the smartphone.

First adjust the volume on your smartphone (to a high level). Then adjust the volume of Infotainment system.

File formats

The audio equipment supports different file formats.

Activating the music function

Connecting the USB or Bluetooth device.

If device already connected, but playback of stored music files not active:

Press **AUDIO** / 🎵, select **SOURCES** and then select the respective source.

Playback of the audio tracks starts automatically.



Playback functions

Interrupting and resuming playback

Touch **||** to interrupt playback. The screen button changes to ▶.

Touch ▶ to resume playback.

Playing the previous or next track

Touch < or >.

Fast forwarding and rewinding

Touch and hold < or >. Release to return to normal playback mode.

Alternatively, you can move the slider showing the current track position to the left or right.

Playing tracks randomly

Touch button repeatedly to toggle between the available random modes.

ON 🔄: play tracks of currently selected list (album, artist, etc.) in random order.

ALL 🔄: play all tracks stored on connected device in random order.

OFF 🔄: play tracks of currently selected list (album, artist, etc.) in normal playback mode.

Repeating tracks

Touch button repeatedly to switch repeat mode on or off.

ON 🔄: repeat tracks of currently selected list (album, artist, etc.).

OFF 🔄: play tracks of currently selected list (album, artist, etc.) in normal playback mode.

Browse music functions

(only available for devices connected via USB)

You can have your music files sorted according to different criteria. Two options are available for browsing the music files stored on the connected USB device.

Browsing via main menu

If you want to change the currently active USB source, select **SOURCES** and then select the desired source. The respective main menu is displayed.

Select the button showing the currently selected sorting criteria, e.g. **Sort: Album** or **Sort: Artist**, and then select the desired new sorting criteria. A sorting process is performed.

Select **List** and then select the desired track.

Playback of the selected track is started.

Browsing via device menu

Select **OPTIONS** and then select **Music files**.

If you want to change the currently active USB source, select **Other**.

Select the desired sorting criteria, e.g. **Albums** or **Artists**, and then select the desired track.

Playback of the selected track is started.

Activating the picture viewer

Connecting the USB device.

If device already connected, but picture viewer not active:

Press **AUDIO** / , select **OPTIONS** and then select **Managing photos**.

Select the desired picture.

A slide show of all stored picture files starts automatically.



Touch the screen to display the menu bar.

Viewing the previous or next picture

Touch  or .

Starting or stopping a slide show

Select  to view the pictures stored on the USB device in a slide show.

Touch  to end the slide show.

Phone projection

The phone projection applications Apple CarPlay and Android Auto display selected apps from your smartphone on the Info Display and allow their operation directly via the Infotainment controls.

Check with the device's manufacturer if this function is compatible with your smartphone and if this application is available in the country you are in.

Preparing the smartphone

iPhone®: Make sure Siri® is activated on your phone.

Android phone: Download the Android Auto app to your phone from the Google Play™ Store.

Connecting the smartphone

iPhone

Connect the phone to the USB port.

If the phone is already connected via Bluetooth, upon connecting to the USB port and launching Apple CarPlay, the Bluetooth connection will disconnect.

Android phone

Connect the phone via Bluetooth ↗ 127 and then connect the phone to the USB port.

Starting phone projection

Press  and then touch

Apple CarPlay or Android Auto.

The phone projection screen displayed depends on your smartphone and software version.

Returning to the Infotainment screen

Press, e.g., the **AUDIO** /  button on the control panel.

Navigation

This chapter is about the embedded navigation system which guides to desired destinations.

The current traffic situation is taken into account in the route calculation. For this purpose, the Infotainment system receives traffic announcements in the current reception area via RDS-TMC.

The navigation system cannot, however, take into account traffic incidents, traffic regulations changed at short notice and hazards or problems that arise suddenly (e.g. road works).

Caution

The usage of the navigation system does not release the driver from the responsibility for a correct, vigilant attitude in road traffic. The relevant traffic regulations must always be followed. If a navigation instruction contradicts traffic regulations, the traffic regulations always apply.

Functioning of the navigation system

The position and movement of the vehicle are detected by the navigation system using sensors. The travelled distance is determined by the vehicle's speedometer signal, turning movements on bends by a sensor. The position is determined by the GPS (Global Positioning System) satellites.

By comparing the sensor signals with the digital maps, it is possible to determine the position with an accuracy of approx. 10 m.

The system will also work with poor GPS reception. However, the accuracy of the determination of the position will be reduced.

After the entry of the destination address or point of interest (nearest petrol station, hotel, etc.), the route is calculated from the current location to the destination selected.

Route guidance is provided by voice output and an arrow, as well as with the aid of a multi-colour map display.

Important information

TMC traffic information system and dynamic route guidance

The TMC traffic information system receives all current traffic information from TMC radio stations. This information is included in the calculation of the overall route. During this process, the route is planned so that traffic problems related to pre-selected criteria are avoided.

To be able to use TMC traffic information, the system must receive TMC stations in the relevant region.

Live navigation

When data sharing and the vehicle position are activated, the navigation system will show online traffic information as well as online information for parking, fuel prices and weather. The services can be stopped at anytime by deactivating data sharing and the vehicle position.

Data sharing and the vehicle position can be activated or deactivated via the privacy menu in the **System settings**.

Network and connected services
⇒ 93.

The privacy menu and the menu for connected services are also accessible via the message icon on the screen.

Map data

All required map data is stored within the Infotainment system.

Map updates are available at a Vauxhall Service Partner or at the MyVauxhall customer portal. To download the map updates from the Vauxhall customer portal, a MyVauxhall account and an empty USB stick with at least 32 GB memory and FAT 32 formatting are necessary.

Download and save the map data on a computer and unpack the data onto the USB stick.

To update the map data in the Infotainment system, connect the USB stick to the Infotainment system, select the navigation function and follow the steps on the Info Display.

The installation of the map update will take up to 1 hour. Do not switch off the engine during the installation process.

Some functions of the Infotainment system, e.g. the navigation function, are not available during the installation process.

Information on the map display

Press **NAV** /  to display the navigation map showing the area around the current location.

Route guidance not active

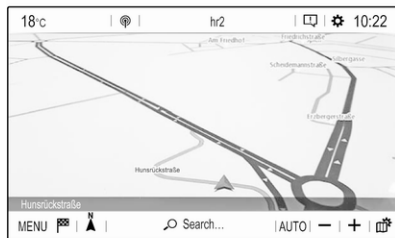

- The map view is displayed.
- The current location is indicated by an arrow.
- The name of the street you are currently in is displayed at the bottom left of the map view.
- Public charging stations are indicated (BEV).

Propulsion types ⇨ 4.

Route guidance active

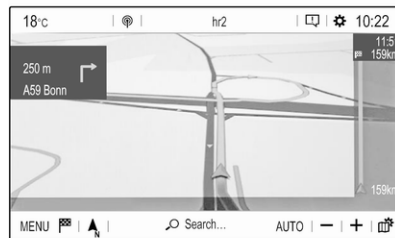

- The map view is displayed.
- The active route is indicated by a coloured line.
- The moving vehicle is marked by an arrow pointing into the direction of travel.
- The next turning manoeuvre is shown in a separate field at the top left of the map view.

Depending on the situation information on lane guidance or the second next turning

manoeuvre may be displayed additionally.

- The arrival time and the remaining distance to the destination is shown at the top right of the map view.

Customise the map display

Map views

Different map views are available.

Touch  to toggle between the different map views.

Depending on the map view, the remaining range is displayed as a circle (BEV).

Propulsion types ⇨ 4.

Map colours

Depending on the external lighting conditions, the colouring of the map screen (light colours for the day and dark colours for the night) can be adapted.

Touch  to display a menu on the right side of the screen.

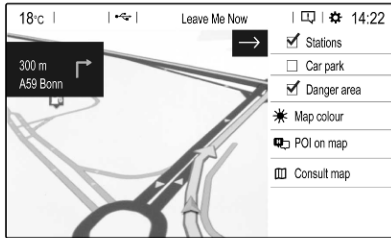

Select **Map colour** repeatedly to toggle between light and dark colours.

POI (Points of Interest) icons on the map

POIs are points of general interest, e.g. petrol stations or car parks.

The display of POI categories shown on the map may be personally adapted.

Activate the desired POI categories. The map view changes accordingly.

Alternatively, select **POI on map** to display a menu with a multitude of POI categories and subcategories to choose from. Activate the desired POI categories.

Traffic events

Traffic events may be indicated on the map. Additionally, information on these events may be displayed in a list.

Select **Consult map** to switch to an alternative map display with new menu options.

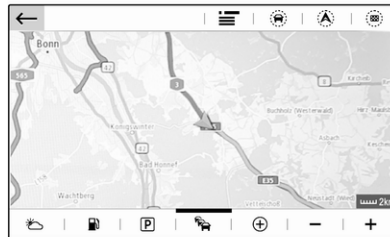

The map view is switched to **North orientation** mode and may display a greater part of the route.

Touch the traffic jam icon to show traffic events on the map. Touch  to show a list with information on these traffic events.

Touch the charging station icon to display a circle that indicates the remaining range (BEV).

Propulsion types ⇨ 4.

If you want to display a different map section:

Touch  to show the area around the current location.

Touch  to show the entire route.

Touch  to show the area around the destination.

To return to the default navigation view, touch .

Propulsion types ⇨ 4.

Autozoom function

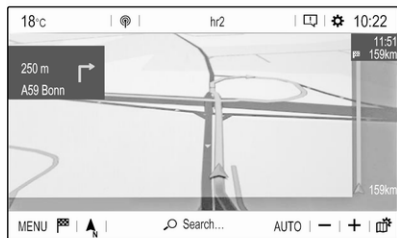

If the autozoom function is activated (**AUTO** is displayed below the map view), the zoom level changes automatically when approaching a turning manoeuvre during active route guidance. This way, you always get a good overview of the respective manoeuvre.

If the autozoom function is deactivated, the selected zoom level remains the same during the whole route guidance process.

To activate or deactivate the function: Select **MENU**, select **Settings** and then select the **Aspect** tab.

Activate or deactivate **Automatic zoom setting**.

Map manipulation

Moving visible map section

Place your finger anywhere on the screen and move it in the desired direction.

The map moves accordingly, displaying a new section. A new button bar is shown.

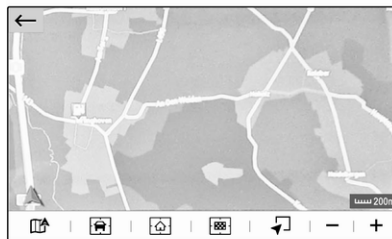

: show area around current location again.

: show area around home address.

: show area around destination.

To return to the default navigation view, select .

Centring visible map section

Touch the desired location on the screen to centre the map around this location.

A red  is displayed at the respective location and the corresponding address is shown on a label.

Manual zooming

To zoom in on a selected map location, place two fingers on the screen and move them away from each other.

Alternatively, touch **+** below the map view.

To zoom out and display a larger area around the selected location, place two fingers on the screen and move them towards each other.

Alternatively, touch **-** below the map view.

Showing an overview of the route

Touch , select **Consult map** and then touch .

The map view is switched to **North orientation** and shows an overview of the current route.

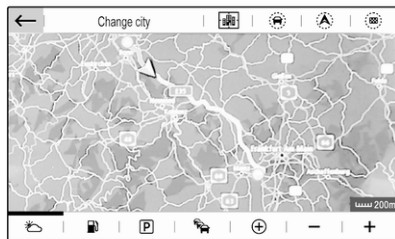

To return to the default navigation view, touch .

Voice guidance

The route guidance process can be supported by voice prompts given out by the system.

To activate or deactivate the function: Select **MENU** in the navigation main menu, select **Settings** and then select the **Vocal** tab.

Activate or deactivate **Activate navigation messages**.

Navigation settings

Select **MENU** in the navigation main menu, and then select **Settings** to display the respective menu with a variety of navigation related settings.

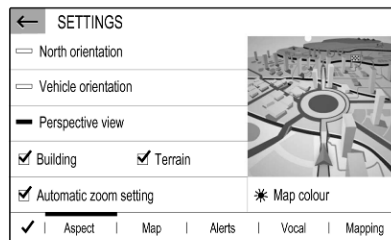

Please explore the different settings. Some have already been described above, others are described in the following sections.

Selecting an address from the map

Touch the desired location on the map. The map centres around this location.

A red is displayed at the respective location and the corresponding address is shown on a label.

To start route guidance, select .



For a detailed description on route guidance.

Quick address or POI search

Select **Search...** A menu with a list of recent destinations and a keyboard is displayed.



To refine the area for your address or POI search, select and then select the desired option.

To hide the keyboard and show the entire list, select . To show the keyboard again, select .

If you want to search for POIs (Points of Interest) only, select the **POI** tab.

Enter an address or search term. As soon as characters are entered an address search is performed and the list of found addresses is updated continuously.

Select the desired list item.

Depending on the current situation and your selection, the navigation system may react differently:

- If the selected list item is a valid destination address and route guidance is currently not active:

The navigation main menu is displayed again and route guidance is started.

For a detailed description on route guidance.

- If the selected list item is a valid destination address but route guidance is already active:

A message is displayed and you need to decide first if the old

destination should be replaced, or if you want to add the selected address as an intermediate destination to a waypoint trip. Detailed description on waypoint trips, see below.

Select the desired option.

- If the navigation system needs more detailed information for route calculation:

Enter a further search term to refine your search.

Detailed address entry

Select **MENU** and then select **Enter address** to display a keyboard for address entry.



As soon as characters are entered, an address search is started. Every additional character is considered in the matching process and a list of matching addresses is displayed.

Select the desired address or change your input to initiate a new search.

Continue with the address entry until the entire address you are searching for is found.

Notice

Make sure that the correct country is selected. To change the country, touch the country code in the upper right corner.

To start route guidance to the respective address, confirm your input.

For a detailed description on route guidance.

Storing your favourite addresses

If you want to store the entered address, select .

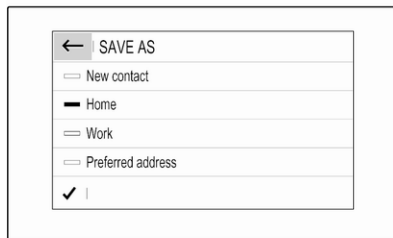

You may store the address as, e.g., your **Home** address or your **Work** address.

Select the desired option, confirm your selection and then enter a name for the address.

The stored address can then be easily selected as destination address via the destination lists **Preferred** or **Contacts**, see below.

Destination lists

Select **MENU** and then select **My destinations**.



Select **Recent** to display a list of all recently entered destinations.

Select **Preferred** to display all destinations which were stored before as home address, work address or preferred address.

Select **Contacts** to display a list with contact names and all related addresses stored before as personal contacts.

To start route guidance to the respective address, select a list entry.

For a detailed description on route guidance.

Points of interest

A point of interest (POI) is a specific location that might be of general interest, e.g. a petrol station, a parking area or a restaurant.

The data stored within the navigation system contains a great number of predefined POIs, which are indicated on the map (if activated).

Selecting a POI from the map

Touch the desired POI icon on the map. The map centres around this location.

Touch the icon again.

A red  is displayed at the respective location and the corresponding address is shown on a label.

To start route guidance, select .

For a detailed description on route guidance.

Showing a list of POIs around a location

Touch the desired location on the map. The map centres around this location.

A red  is displayed at the respective location and the corresponding address is shown on a label.

Touch and hold .

A list of POIs around the location is displayed.

Select the desired POI to start route guidance.

For a detailed description on route guidance.

Searching for POIs via categories

Select **MENU** and then select **Points of interest**.

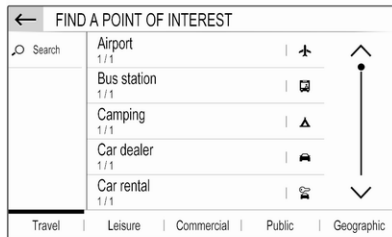

Select a POI main category, e.g., **Travel** and then select a subcategory, e.g. **Airport**. A new menu is displayed.

Select a search area, e.g., **Around the vehicle** to refine the search.

After the POI search is performed, select the desired POI.

To search for POIs at another location, select **Address**.

To search for POIs via keyword (see below), select **Search**.

Searching via keyword

Select **MENU**, select **Search**, enter a keyword, e.g., "Station", enter or select a city name and confirm your input.

After the POI search is performed, select the desired POI.

Waypoint trips

A waypoint is an intermediate destination that is considered in the calculation of a route to its final destination. To create a waypoint trip, you may add one or several waypoints.

Enter or select the final destination of your waypoint trip and start route guidance.

While under active route guidance, select **MENU** and then select **Route / Waypoints**.

← ROUTE AND WAYPOINTS		↑↓
⊕ Add waypoint	BNJ Bonn-Hangelar 123 Richthofenstraße, Hangelar	1
☰ Overview	CGN Köln Bonn Airport: Terminal 2 Kennedystraße, Gremgel	2
📍 Finish	Rüsselsheim Stahlstraße	☰
Waypoints		Route

Select **Add waypoint** and then select an option for address entry, e.g. **Find POI**.

Enter or select a new address. The address is inserted into the list of waypoints.

If desired, enter further waypoints as described above.

If you want to change the order of the waypoints:

Touch **↑↓** and then touch the displayed arrows to move the list entries up or down.

Select **Calculate** to recalculate the route according to the changed order.

To return to the navigation main menu, select **Finish**.

To display a detailed route list of the waypoint trip, select the **Route** tab.

← ROUTE AND WAYPOINTS		☰
⊕ Add waypoint	60 m Alexanderstraße Turn right	↑
☰ Overview	400 m B1/B5 Alexanderstraße Turn right	↔
📍 Finish	8 km Wexstraße, Tegel Turn right	↘
	8 km A100, Magdeburg Bear left	↙
	9 km A100	↑
Waypoints		Route

Route guidance

Route guidance is provided by the navigation system through visual instructions and voice prompts (voice guidance).

Visual instructions

Visual instructions are provided on the display.

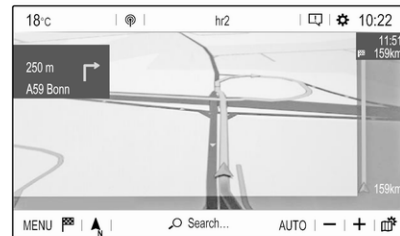

Notice

When route guidance is active and you are not within the navigation application, turning manoeuvres are shown on the instrument cluster display.

Voice guidance

Navigation voice prompts announce which direction to follow, when approaching an intersection at which you need to turn.

To activate or deactivate the voice prompts function select **MENU** in the navigation main menu, select **Settings**, select the **Vocal** tab and then activate or deactivate **Activate navigation messages**.

If voice prompts are activated you can additionally specify whether street names should be spoken or not.

To replay the last voice guidance instruction, touch the turn arrow on the left side of the screen.

Settings for route guidance

Select **MENU** in the navigation main menu and then select **Guidance criteria** to display the respective menu.

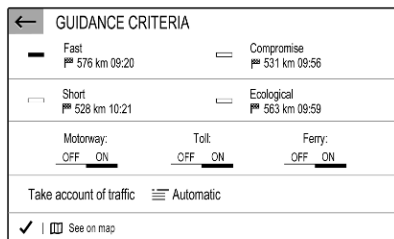

When the menu is opened, several optional routes are automatically calculated by the navigation system, e.g. the fastest route or the most ecological route.

To show the different optional routes on a map, select **See on map**.

If you want, e.g., avoid motorways on your route, set the respective option to **OFF**.

Take account of traffic

Traffic events are taken into consideration when the system determines a route to a destination.

During active route guidance, the route can be modified according to incoming traffic messages.

Three options are available for **Take account of traffic**:

If you want the system to automatically modify the route according to new traffic messages, select **Automatic**.

If you want to be consulted when a route is modified, select **Manual**.

If you do not want routes to be modified, select **None**.

Starting, cancelling, resuming route guidance

To start route guidance, enter or select a destination address. Depending on the situation, route

guidance may start automatically, or you may have to follow some instructions on the screen.

To cancel route guidance, select **MENU** in the navigation main menu and then select **STOP NAVIGATION**.

To resume a cancelled route guidance, select **MENU** in the navigation main menu and then select **RESUME GUIDANCE**.

Turn list

The next turning manoeuvre is displayed on the left side of the screen.

To display a list of all upcoming turns on the active route, select **MENU** in the navigation main menu, select **Route / Waypoints** and then select the **Route** tab.

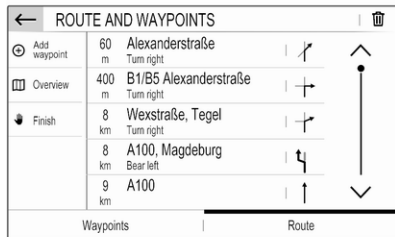

To display a turning manoeuvre on the map, touch the turn arrow icon next to the desired list entry. The map jumps to the respective location on the map.



To display the previous or next turning manoeuvre on the map, touch < or >.

To avoid the route section currently displayed on the map, touch ↻.

If desired, further route sections may be selected to be avoided.

Confirm your selection(s).

Speech recognition

Embedded speech recognition

The embedded speech recognition of the Infotainment system enables you to operate various functions of the Infotainment system via voice input. It recognises commands and numeric sequences independently of the relevant speaker. The commands and numeric sequences can be spoken without a voice pause between the individual words.

In the event of incorrect operation or commands, the speech recognition gives visual and / or acoustic feedback and requests you to re-enter the desired command. Apart

from this, the speech recognition acknowledges important commands and will enquire if necessary.

In general, there are different ways to speak commands for performing the desired actions.

Notice

To ensure that conversations inside the vehicle do not lead to unintentional triggering of the system functions, the speech recognition does not start until it has been activated.

Important information

Language support

- Not all languages available for the display of the Infotainment system are also available for the speech recognition.
- If the display language currently selected is not supported by the speech recognition, speech recognition is not available.

In such a case, you need to select another language for the display if you want to control the Infotainment system via voice

input. To change the display language ↷ 93.

Address input of destinations in foreign countries

In case you want to enter the address of a destination located in a foreign country via voice input, you need to change the language of the Info Display to the language of the foreign country.

E.g., if the display is currently set to English and you want to enter the name of a city located in France, you need to change the display language to French.

For changing the display language, see "Language" in chapter "System settings" ↷ 93.

Input order for destination addresses

The order in which the parts of an address need to be entered using the speech recognition system is dependent on the country where the destination is located.

If the speech recognition system rejects your address entry, repeat the command with a different order of the address parts.

Activating speech recognition

Notice

Speech recognition is not available during an active phone call.

Activation via the button on the steering wheel



Press  on the steering wheel.

The audio system mutes, a voice output message prompts you to say a command, and help menus with the most important commands currently available are shown on the display.

The speech recognition is ready for voice input, after a beep has been given.

You can now say a voice command to initiate a system function (e.g. playing a preset radio station).

Adjusting the volume of voice prompts

Press volume button on the steering wheel upwards (increase volume)  or downwards (decrease volume) .

Interrupting a voice prompt

As an experienced user, you can interrupt a voice prompt by briefly pressing  on the steering wheel.

Alternatively you can say "Set dialogue mode as expert".

A beep is heard immediately, and a command can be stated without having to wait.

Cancelling a dialogue sequence

To cancel a dialogue sequence and to deactivate the speech recognition, press  on the steering wheel.

If you do not say any command for a certain period of time, or if you say commands that are not recognised by the system, a dialogue sequence is automatically cancelled.

Operation via speech commands

Follow the instructions given by voice output and shown on the display.

For best results:

- Listen for the voice prompt and wait for the beep before saying a command or replying.
- Read the example commands on the display.
- The voice prompt can be interrupted by pressing  again.
- Wait for the beep and then speak the command naturally, not too fast, not too slow.

Usually commands can be spoken in a single command.

Voice pass-thru application



The voice pass-thru application of the Infotainment system allows access to the speech recognition commands on your smartphone.

Voice pass-through is available via the phone projection applications Apple CarPlay and Android Auto.

Activating speech recognition

Press and hold  on the steering wheel until a speech recognition session is started.

Adjusting the volume of voice prompts

Turn  on the control panel or press volume button on the steering wheel upwards (increase volume)  or downwards (decrease volume) .

Deactivating speech recognition

Press  on the steering wheel. The speech recognition session is ended.

Phone

The phone function provides you with the possibility of having mobile phone conversations via a vehicle microphone and the vehicle loudspeakers as well as operating the most important mobile phone functions via the Infotainment system in the vehicle. To be able to use the phone function, the mobile phone must be connected to the Infotainment system via Bluetooth.

Not all phone functions are supported by every mobile phone. The usable phone functions depend on the relevant mobile phone and network provider. You can find further information on this in the operating

instructions for your mobile phone, or you can enquire about them with your network provider.

Important information for operation and traffic safety

Warning

Mobile phones have effects on your environment. For this reason safety regulations and directions have been prepared. You should be familiar with the related directions before you use the telephone function.

Warning

Use of the hands-free facility while driving can be dangerous because your concentration is reduced when telephoning. Park your

vehicle before you use the hands-free facility. Follow the stipulations of the country in which you find yourself at present.

Do not forget to follow the special regulations that apply in specific areas and always switch off the mobile phone if the use of mobile phones is prohibited, if interference is caused by the mobile phone or if dangerous situations can occur.

Pairing a device

During the pairing process, PIN code exchange between the Bluetooth device and the Infotainment system and connection of the Bluetooth devices to the Infotainment system are carried out.

Important information



- Two paired Bluetooth devices can be connected to the Infotainment system at the same time. One device in hands-free mode, the other in audio streaming mode, see description

on Bluetooth profile settings below.

However, two devices cannot be used in hands-free mode at the same time.

- Pairing only needs to be carried out once, unless the device is deleted from the list of paired devices. If the device has been connected previously, the Infotainment system establishes the connection automatically.
- Bluetooth operation considerably drains the device's battery. Therefore, connect the device to the USB port for charging.

Pairing a new device

1. Activate the Bluetooth function of the Bluetooth device. For further information, see the operating instructions for the Bluetooth device.
2. If another Bluetooth device is already connected:
Press , select **OPTIONS**, select **Bluetooth connection** and then touch  **Search**.

If no Bluetooth device is currently connected:

Press  and then touch **Bluetooth search**.

A search for all Bluetooth devices in the near environment is performed.

3. Select the Bluetooth device you wish to pair from the displayed list.
4. Confirm the pairing procedure:
 - If SSP (secure simple pairing) is supported:
Confirm the messages on the Infotainment system and the Bluetooth device.
 - If SSP (secure simple pairing) is not supported:
On the Infotainment system: a message is displayed asking you to enter a PIN code on your Bluetooth device.
On the Bluetooth device: enter the PIN code and confirm your input.
5. Activate the functions you want the paired smartphone to perform

and confirm your settings. You can change these Bluetooth profile settings at any time, see below.

The Infotainment system and the device are paired.

- The phone book is downloaded automatically to the Infotainment system. Depending on the phone, the Infotainment system must be allowed access to the phone book. If required, confirm the messages displayed on the Bluetooth device.

If this function is not supported by the Bluetooth device, a corresponding message is displayed.

Operations on paired devices

Press , select **OPTIONS** and then select **Bluetooth connection**.

A list of all paired devices is displayed.

Changing the Bluetooth profile settings

Touch  next to the desired paired device.

Activate or deactivate the profile settings as desired and confirm your settings.

Connecting a paired device

Devices which are paired but not connected are identified by .



Select the desired device to connect it.

Disconnecting a device

The currently connected device is identified by .



Select the device to disconnect it.

Deleting a paired device

Touch  in the upper right corner of the screen to display  icons next to each paired device.

Touch  next to the Bluetooth device you want to delete and confirm the displayed message.

Phone main menu

Press  /  to display the phone main menu.

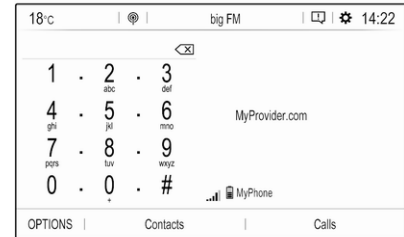

Many functions of the mobile phone can now be controlled via the phone main menu (and associated submenus), and via the phone-specific controls on the steering wheel.

Initiating a phone call

Entering a phone number

Enter a phone number using the keypad in the phone main menu.



As soon as figures are entered, matching entries from the contacts list are displayed in alphabetical order.

Touch the desired list entry to initiate a phone call.

Using the contacts list

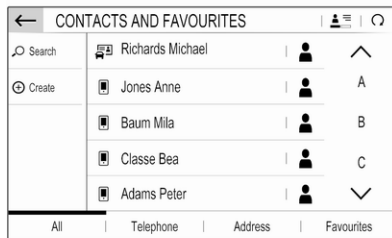

The contacts list contains all phone book entries from the connected Bluetooth device and all contacts from the navigation system.

Select **Contacts** and then select the desired list type.



Searching for a contact

The contacts are ordered by the first name or surname. To change the order, touch .

To scroll through the list, use the scroll bar,  or .

To search for a contact via keyboard, touch **Search**.

Modifying or deleting a contact

Select  next to the contact and then select the desired option.

If you want to add a photo to the contact:

Connect a USB device with the desired photo stored on it to the USB port  111, touch the photo frame and then select the desired photo.

Confirm your selection to download the selected photo to the system.

Using the call history

All incoming, outgoing, or missed calls are registered.

Select **Calls** and then select the desired list.

Select the desired list entry to initiate a call.

Incoming phone call

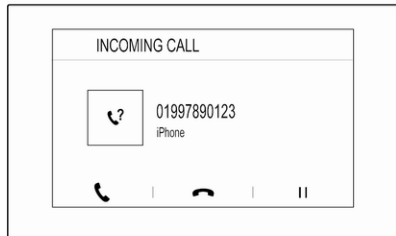

If an audio mode, e.g. the radio or USB mode, is active at the moment a call comes in, the audio source is muted and stays muted until the call ends.

A message with the caller's phone number or name is displayed.



To answer the call, touch .



To reject the call, touch .

To put the call on hold, touch . To resume to the call, touch .

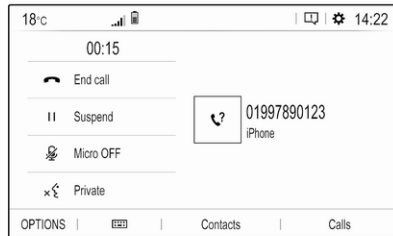
During the ongoing call, the following menu is displayed.



To mute the microphone of the Infotainment system, touch **Micro OFF**.

To continue conversation via the mobile phone (private mode), touch  **Private**. To reactivate the conversation via the Infotainment system, touch  **Private**.

Notice

If you leave the vehicle and lock it while you are still in a private mode phone conversation, the Infotainment system may remain switched on until you leave the Bluetooth reception area of the Infotainment system.

Put incoming calls always on hold

For safety reasons the phone function can put all incoming calls on hold by default.

To activate this function, select **OPTIONS**, select **Security** and then select **Put incoming calls on hold**.

Quick messages

Different quick messages can be sent to contacts via the Infotainment system.

Select **OPTIONS** and then **Quick messages** to display a list of quick messages sorted by different categories.

To send a quick message, select the respective message and choose the contact.

Multimedia

Introduction

Important information on operation and traffic safety

Warning

Drive safely at all times. Only operate the Infotainment system if the traffic conditions allow a safe usage.

In the interest of safety, it might be appropriate to stop the vehicle before operating the Infotainment system.

Warning

The usage of a navigation app does not release the driver from the responsibility for a correct, vigilant attitude in road traffic. Always follow the applicable traffic rules.

Radio reception

Radio reception may be disrupted by static, noise, distortion or loss of reception due to:

- changes in distance from the transmitter
- multi-path reception due to reflection
- shadowing

Theft-deterrent feature





The Infotainment system is equipped with an electronic security system for the purpose of theft deterrence.

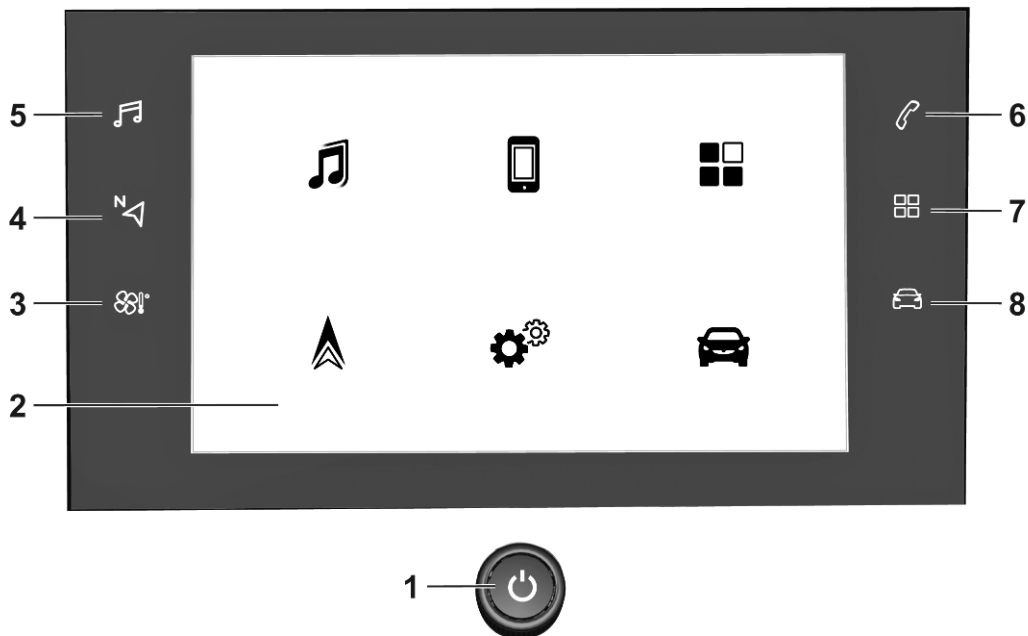

The Infotainment system therefore functions only in your vehicle and is worthless to a thief.

Multimedia

Control panel – Multimedia / Radio (Infotainment system)



- 1 
 - If switched off: switch power on / off
 - If switched on: mute system
 - Turn: adjust volume
- 2 Info Display
 - Home menu will be displayed by a 3-finger touch on screen
- 3 
 - Open climate menu if available
- 4 
 - Display navigation app when phone projection is active 143
- 5 
 - Open audio menu:
 - Radio 141
 - External devices (USB, Bluetooth) 143

- 6 
 - Open phone menu 148
 - Display phone projection screen when phone projection is active 143
- 7 
 - Open menu for picture function 143
- 8 
 - Open vehicle settings menu

Steering wheel controls

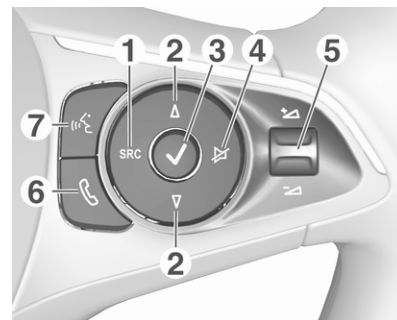

- 1 **SRC (Source)**
 - Select audio source, confirm selection with ✓
 - Long press: mute system
- 2 **Δ / ▽**
 - Select next / previous preset radio station when radio active 141
 - or select next / previous track / picture when external devices active 143

or select next / previous entry in station list, media list, call / contacts list when operation started via steering wheel controls

Confirm selection with ✓

3 ✓

Confirm selected item

or open station list, media list

4 

Activate / deactivate mute function

5 

Turn upwards / downwards: increase / decrease volume

6 

Short press: accept incoming call

Long press: reject incoming call, hang up call .. 148

or open call / contacts list ... 148

If phone call active: open call in progress menu

7 

(with embedded speech recognition)

Short press: activate embedded speech recognition

Long press: activate speech recognition in Apple CarPlay™ or Android™ Auto if phone connected via USB port 146

(without embedded speech recognition)

Short press: activate speech recognition in Apple CarPlay™ or Android™ Auto if phone connected via USB port

Control elements

The Infotainment system is operated via function buttons, a touch screen and menus that are shown on the display.

Inputs are made optionally via:

- the control panel on the Infotainment system
- the touch screen
- audio controls on the steering wheel
- the speech recognition ⇨ 146

Switching the Infotainment system on or off

Press . After switching on, the last selected Infotainment source becomes active.

Notice

Some functions of the Infotainment system are only available if ignition is switched on or engine is running.

Automatic switch-off

If the Infotainment system has been switched on pressing  while the ignition is switched off, it will switch off again automatically when the Eco mode becomes active.

Setting the volume

Turn . The current setting is shown on the display.

When the Infotainment system is switched on, the last selected volume is set.

Speed compensated volume

When the speed compensated volume is activated, the volume is adapted automatically to make up for the road and wind noise as you drive.

Mute

Press  to mute the Infotainment system.

To cancel the mute function, press  again. The last selected volume is set again.

Modes of operation

Audio-Media

Press  to display the main menu of the last selected audio mode.

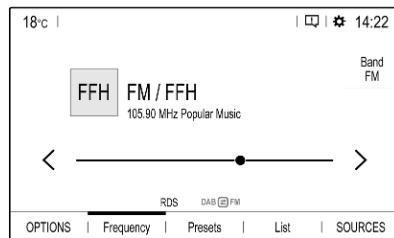

Changing the media source

Select **SOURCES** to display the menu for media source selection.

Select the desired media source.

For a detailed description of:

- Radio functions ⇨ 141
- External devices ⇨ 143

Phone

Before the phone function can be used, a connection has to be established between the Infotainment system and the mobile phone.

For a detailed description of preparing and establishing a Bluetooth connection between the Infotainment system and a mobile phone ⇨ 148.

If the mobile phone is connected, press  to display the main menu of the phone function.

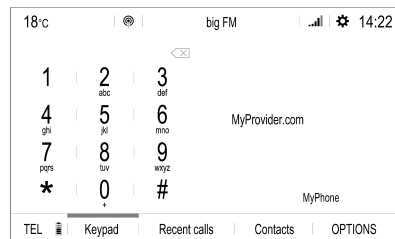

For a detailed description of mobile phone operation via the Infotainment system ⇨ 148.

Apps

To show specific apps of your smartphone on the display of the Infotainment system, connect your smartphone.

Press  and touch **Apple CarPlay** or **Android Auto**. A menu with different selectable apps is displayed.

For a detailed description ⇨ 143.

Settings

Press , select **OPTIONS** and then select **Audio settings** to display the respective menu.

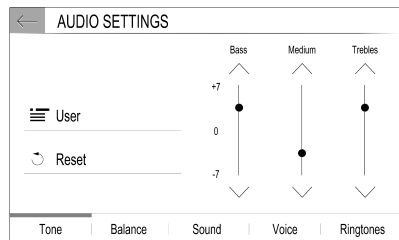

For a detailed description.

Touch the top bar  of the screen to display a menu for various system-related settings.

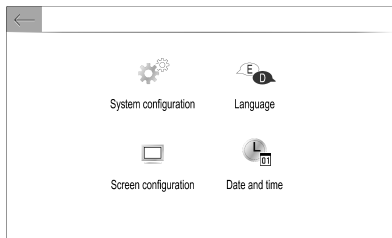

For a detailed description.

Vehicle settings

Select  to open a menu for various vehicle-related settings.

Vehicle personalisation ⇨ 81.

Settings center

The **Settings center** provides quick access to the following settings:

- dark screen
- brightness
- profiles
- system configuration
- privacy settings

Touch the top bar  of the screen to display the **Settings center**.

Menu operation

The display of the Infotainment system has a touch-sensitive surface that allows direct interaction with the displayed menu controls.

Caution

Do not use pointed or hard items like ballpoint pens, pencils or similar for touch screen operation.

Selecting or activating a screen button or menu item

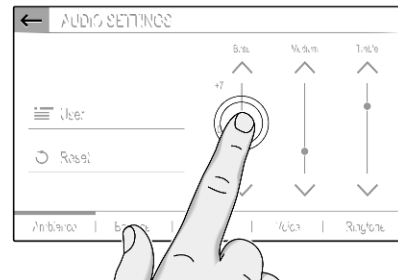

Touch a screen button or menu item.

The corresponding system function is activated, a message is shown, or a submenu with further options is displayed.

←, X and ✓ / OK screen buttons

When operating the menus, touch ← or X in the respective submenu to return to the next higher menu level.

When no ← or X screen button is displayed, you are on the top level of the respective menu.

On some screens ✓ / OK needs to be touched for confirmation after selecting menu items or changing settings. Otherwise all performed selections or settings will be lost.

Scrolling a list

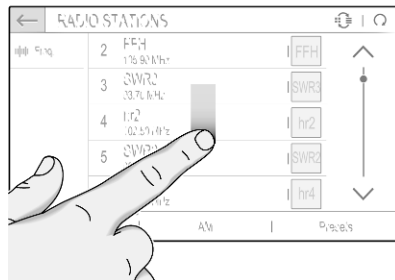

If there are more items available than presentable on the screen, the list must be scrolled.

To scroll through a list of menu items, you may optionally:

- Place your finger anywhere on the screen and move it upwards or downwards.

Notice

Constant pressure must be applied and the finger must be moved at a constant speed.

- Touch ^ or v at the top or bottom of the scroll bar.

- Touch anywhere on the guiding line of the scroll bar.
- Move the slider of the scroll bar up and down with your finger.

Updating a list

Touch ↻ to manually update lists, e.g. the station list.

Input fields and keyboards

Input fields are indicated by ✎.

Touch the input field to open a keyboard for text or number input.

Depending on the application or function currently active, different keyboards are displayed.

Keyboards for text input

Keyboards for text input may contain several input fields. To enable a field for text input, touch it.

To enter a character, touch the respective screen button. The character is entered upon release.

Touch and hold a letter screen button to display associated letters in a letter pop-up menu. Release and then select the desired letter.

To switch to the symbol keyboard, touch **0..#**.

To switch back to the letter keyboard or to switch between capital and small letters, touch **Aa**.

To switch the letter keyboard between normal order and alphabetical order, touch .

To delete the most recently entered character or symbol, touch .

Audio settings

Press , select **OPTIONS** and then select **AUDIO SETTINGS**.

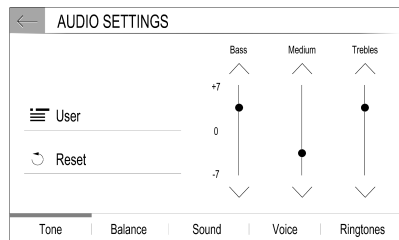

Several predefined settings are available to optimise the tone for a specific style of music (e.g. **Pop-Rock** or **Classical**).

To adjust the tone individually, select **User**. Change the settings as desired.

Notice

If you change the settings of a predefined setting, e.g. **Pop-Rock**, this settings will be applied to the **User** or **Personalised** setting.

Balance and fader

Select the **Balance** tab.

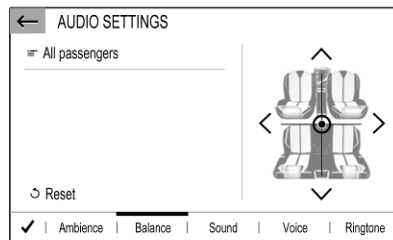

Several predefined settings are available to adjust the volume distribution inside the vehicle (e.g. **All passengers** or **Front only**).

To change the current setting, e.g. **All passengers**, select that setting and then select the desired new setting from the displayed list.

You may individually adjust the predefined settings.

To define the point in the passenger compartment where the volume is at its highest level, move the cursor in the illustration on the right side of the screen to the desired point.

To return to the default factory settings, select .

Volume settings

Press , select **OPTIONS** and then select **AUDIO SETTINGS**. Then select the **Sound** tab.

Audible touch feedback

If the audible touch feedback function is activated, each touch of a screen button or menu item is indicated by a beeping sound.

To adjust the touch beep volume, activate **Touch tones** and then adjust the setting.

Speed compensated volume

Activate or deactivate **Volume linked to speed**.

If activated, the volume of the Infotainment system is adapted automatically to make up for the road and wind noise as you drive.

Speech output

Select the **Voice** tab.

Adjust the volume for all speech outputs of the system.

Ringtone

Select the **Ringtones** tab.

Adjust the ringtone volume of incoming calls.

System settings

Touch the top bar  of the screen to display the **Settings center**.

The configuration menu is accessible via the **Settings center**.

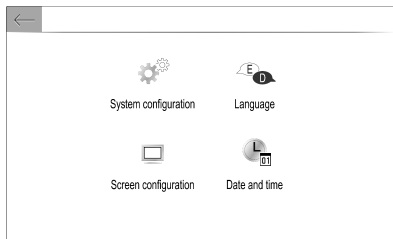

Configuring the system

Select **System configuration** to perform some basic system configurations, e.g.:

- Adjust the display of units for temperature or fuel consumption.
- Reset the system configuration to factory defaults.
- Update the installed software version.
- Adjust the privacy settings for data sharing and vehicle position.

Changing display language

To adjust the language for the menu texts, select **Language** and then select the desired language.

Notice

If the selected display language is supported by the embedded speech recognition, the language of the speech recognition will be changed accordingly; if not, embedded speech recognition will be not available.

Adjusting time and date

Select **Date and time**.

To adjust the time and date, select the respective tabs.

Adjusting the screen

Select **Screen configuration**.

Text scroll function

Select the **Animation** tab.

If long texts on the screen should be scrolled automatically, activate **Automatic scrolling**.

If **Automatic scrolling** is deactivated, long texts are truncated.

Adjusting the brightness

Select **Brightness** and set the brightness of the screen to the desired level.

Storing your personal settings

To go to the profile settings, touch the top bar of the screen  and then select **Profiles**.

You can store a multitude of settings in a personal profile. For example, all current tone settings, all radio presets and a phone book.

In case you share the vehicle with other people, this enables you to restore your personal settings from your profile at any time.

A maximum of three personal profiles may be stored.

Additionally, a **Common profile** is available. All settings done at any time are automatically stored in that profile. If no personal profile is activated, the **Common profile** is active.

Storing your personal profile

After performing all your personal settings:

Select one of the personal profile tabs.

Select the input field  and enter the desired name of your personal profile.

Finally, confirm your inputs to store them in your personal profile.

Activating your personal profile

Touch the top bar  of the screen, then select **Profiles** and then select the tab with the name of your personal profile.

Activating the Common profile

If a personal profile is currently active:

Go to the **Common profile** tab and then select **Activate profile**.

Resetting a personal profile

You can at any time reset a personal profile to restore the default factory settings on that profile.

Activate the respective profile and then select **Reset the profile**.

Resetting the Common profile

You can at any time reset the **Common profile** to restore the default factory settings on that profile.

Select **Common profile** and then select **Reset the common profile**.

Audio

Activating the radio

Press . The audio main menu last selected is displayed.

If the radio main menu is not active, select **SOURCES** and then select **Radio**.

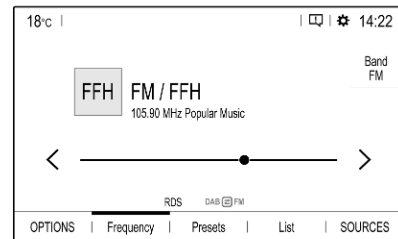

The station last played will be received.

Selecting a waveband

Select **OPTIONS** and repeatedly touch  to toggle between the different wavebands.

Searching for stations

Automatic station search

Briefly touch < or > to play the previous or next receivable station.

Manual station search

Press and hold < or >. Release when the required frequency has almost been reached.

A search is made for the next station that can be received and it is played automatically.

Station lists

In the station lists, all receivable radio stations within the current reception area are available for selection.

To display the station list of the waveband currently active, select **List**.

Select the desired station.

Update station lists

If the stations stored in the waveband-specific station list can no longer be received, the station lists must be updated.

To start an update for the currently active waveband, select Ω .

Storing favourite stations

Up to 24 radio stations of all wavebands can be stored as favourites in the **Presets** list.

Select **Presets** to display the preset buttons.

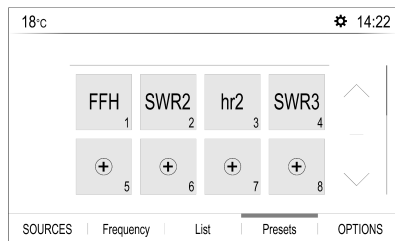

Storing the currently active station

Touch and hold the desired button in the **Presets** list for a few seconds. The respective frequency or station name is displayed on the button.

If a station is already stored on a preset button, that station will be overwritten by the new one.

Alternatively, touch **★ Mem** in the radio main menu to store the currently active station.

Storing a station from a station list

Select **OPTIONS** and then select the desired waveband.

To store a station from the station list, briefly touch **★** next to the desired station. The station is stored and the number of the preset button will be displayed. To delete a station, touch **★** again.

Alternatively, touch and hold the name of the station until it is stored. To delete the station, touch and hold the name of the station again until a corresponding message is displayed.

Retrieving stations

In the radio main menu select **Presets** and then briefly touch the preset button of the desired station.

Activating RDS

In the radio main menu, select **OPTIONS** and activate **RDS**.

If **RDS** is activated, **RDS** is displayed in the bottom line of the radio main menu.

Radio text

If RDS is activated, information on the radio programme currently active or the music track currently playing are displayed below the programme name.

To show or hide the information, go to the **OPTIONS** menu and activate or deactivate **Information**.

Traffic announcements

Many RDS stations broadcast traffic news. If the traffic announcements function is activated, radio or media playback is interrupted for the duration of a traffic announcement.

To activate traffic announcements, go to the **OPTIONS** menu and activate **TA**.

If **TA** is activated, **TA** is displayed in the bottom line of the radio main menu.

Digital audio broadcasting

Digital audio broadcasting (DAB) broadcasts radio stations digitally.

DAB stations are indicated by the programme name instead of the broadcasting frequency.

FM-DAB Linking

This function enables switching from an FM station to a corresponding DAB station and vice versa.

Switching from FM to DAB occurs as soon as a corresponding DAB station is available. Therefore, it is recommended to store favourite stations as DAB stations to reduce frequent switching.

Switching from DAB to FM occurs if the signal is too weak to be picked up by the receiver and the corresponding FM station is available.

Notice

After switching, the volume might be different.

Activation

Precondition is that **RDS** is activated before FM-DAB Linking can be activated.

To activate FM-DAB Linking, select **OPTIONS** in the radio main menu and then select **FM-DAB Follow-up**.

The following symbol will be displayed when FM-DAB Linking is activated:



Deactivation

To deactivate FM-DAB Linking, select **OPTIONS** in the radio main menu and then deselect **FM-DAB Follow-up**.

FM-DAB Linking will automatically be deactivated when **RDS** is deactivated.

External devices

A USB port is located in the centre console.

Caution

To protect the system, do not use a USB hub.

Notice

The USB ports must always be kept clean and dry.

USB ports

An MP3 player, USB device, SD card (via USB connector / adapter) or smartphone can be connected to the USB port.

The Infotainment system can play audio files or show picture files contained in USB devices.

When connected to a USB port, various functions of the devices mentioned above can be operated via the controls and menus of the Infotainment system.

Notice

Not all auxiliary devices are supported by the Infotainment system.

Connecting / disconnecting a device

Connect one of the devices mentioned above to a USB port. If required, use the appropriate connection cable. The music function starts automatically.

Notice

If a non-readable USB device is connected, a corresponding error message appears and the Infotainment system automatically switches to the previous function.

To disconnect a USB device, select another function and then remove the USB device.

Caution

Avoid disconnecting the device during playback. This may damage the device or the Infotainment system.

Bluetooth audio streaming

Streaming allows you to listen to music from your smartphone.

For a detailed description on how to establish a Bluetooth connection ⇨ 148.

If audio playback does not start automatically, it may be necessary to start the playback on the smartphone.

First adjust the volume on your smartphone (to a high level). Then adjust the volume of Infotainment system.

File formats

The audio equipment supports different file formats.

Activating the music function

Connecting the USB or Bluetooth device.



If device already connected, but playback of stored music files not active:

Press , select **SOURCES** and then select the respective source.

Playback of the audio tracks starts automatically.

Playback functions

Interrupting and resuming playback

Touch  to interrupt playback. The screen button changes to .

Touch  to resume playback.

Playing the previous or next track

Touch < or >.

Fast forwarding and rewinding

Touch and hold < or >. Release to return to normal playback mode.

Alternatively, you can move the slider showing the current track position to the left or right.

Playing tracks randomly

Select **OPTIONS** and touch the **Random** icon repeatedly:

: play tracks of currently selected list (album, artist, etc.) in random order.

: play all tracks stored on connected device in random order.

: play tracks of currently selected list (album, artist, etc.) in normal playback mode.

Repeating tracks

Select **OPTIONS** and touch the **Repeat** icon  repeatedly to select one of the following options:

: repeat tracks of currently selected list (album, artist, etc.)

: repeat tracks of currently selected list (album, artist, etc.) once

: play tracks of currently selected list (album, artist, etc.) in normal playback mode

Activating the picture viewer

Connecting the USB device.

If device already connected, but picture viewer not active:

Press , select **Photos** and choose the desired folder and picture.



Touch the screen to display the menu bar.

Viewing the previous or next picture

Touch ◀◀ or ▶▶.

Starting or stopping a slide show

Select ▶ to view the pictures stored on the USB device in a slide show.

Touch || to end the slide show.

Phone projection

The phone projection applications Apple CarPlay and Android Auto display selected apps from your smartphone on the Info Display and allow their operation directly via the Infotainment controls.

Check with the device's manufacturer if this function is compatible with your smartphone and if this application is available in the country you are in.

Preparing the smartphone

iPhone®: Make sure Siri® is activated on your phone.

Android phone: Download the Android Auto app to your phone from the Google Play™ Store.

Connecting the smartphone iPhone

Connect the phone to the USB port.

If the phone is already connected via Bluetooth, upon connecting to the USB port and launching Apple CarPlay, the Bluetooth connection will disconnect. After disconnecting the USB connection, the phone will be connected via Bluetooth again.

Android phone

Connect the phone via Bluetooth
⇨ 148 and then connect the phone to the USB port.

Starting phone projection

If phone projection is not starting automatically, press  and then touch **Apple CarPlay** or **Android Auto**.

The phone projection screen displayed depends on your smartphone and software version.

Returning to the Infotainment screen

Press, e.g., the  button on the control panel.

Speech recognition

Embedded speech recognition

The embedded speech recognition of the Infotainment system enables you to operate various functions of the Infotainment system via voice input. It recognises commands and numeric sequences independently of the relevant speaker. The commands and numeric sequences can be spoken without a voice pause between the individual words.

In the event of incorrect operation or commands, the speech recognition gives visual and / or acoustic feedback and requests you to re-enter the desired command. Apart from this, the speech recognition acknowledges important commands and will enquire if necessary.

In general, there are different ways to speak commands for performing the desired actions.

Notice

To ensure that conversations inside the vehicle do not lead to unintentional triggering of the

system functions, the speech recognition does not start until it has been activated.

Important information

Language support

- Not all languages available for the display of the Infotainment system are also available for the speech recognition.
- If the display language currently selected is not supported by the speech recognition, speech recognition is not available.

In such a case, you need to select another language for the display if you want to control the Infotainment system via voice input. To change the display language ⇨ 132.

Activating speech recognition

Notice

Speech recognition is not available during an active phone call.

Activation via the button on the steering wheel



Press  on the steering wheel.

The audio system mutes, a voice output message prompts you to say a command, and help menus with the most important commands currently available are shown on the display.

The speech recognition is ready for voice input, after a beep has been given.

You can now say a voice command to initiate a system function (e.g. playing a preset radio station).

Adjusting the volume of voice prompts

Press volume button on the steering wheel upwards (increase volume)  or downwards (decrease volume) .

Interrupting a voice prompt

As an experienced user, you can interrupt a voice prompt by briefly pressing  on the steering wheel.

Alternatively you can say "Set dialogue mode as expert".

A beep is heard immediately, and a command can be stated without having to wait.

Cancelling a dialogue sequence

To cancel a dialogue sequence and to deactivate the speech recognition, press  on the steering wheel.

If you do not say any command for a certain period of time, or if you say commands that are not recognised by the system, a dialogue sequence is automatically cancelled.

Operation via speech commands

Follow the instructions given by voice output and shown on the display.

For best results:

- Listen for the voice prompt and wait for the beep before saying a command or replying.
- Read the example commands on the display.
- The voice prompt can be interrupted by pressing  again.
- Wait for the beep and then speak the command naturally, not too fast, not too slow.

Usually commands can be spoken in a single command.

Voice pass-thru application



The voice pass-thru application of the Infotainment system allows access to the speech recognition commands on your smartphone.

Voice pass-through is available via the phone projection applications Apple CarPlay and Android Auto.

Activating speech recognition

Press (without embedded speech recognition) or press and hold (with embedded speech recognition)  on the steering wheel until a speech recognition session is started.

Adjusting the volume of voice prompts

Turn  on the control panel or press volume button on the steering wheel upwards (increase volume)  or downwards (decrease volume) .

Deactivating speech recognition

Press  on the steering wheel. The speech recognition session is ended.

Phone

The phone function provides you with the possibility of having mobile phone conversations via a vehicle microphone and the vehicle loudspeakers as well as operating the most important mobile phone functions via the Infotainment system in the vehicle. To be able to use the phone function, the mobile phone must be connected to the Infotainment system via Bluetooth.

Not all phone functions are supported by every mobile phone. The usable phone functions depend on the relevant mobile phone and network provider. You can find further information on this in the operating instructions for your mobile phone, or you can enquire about them with your network provider.

Important information for operation and traffic safety

Warning

Mobile phones have effects on your environment. For this reason safety regulations and directions have been prepared. You should be familiar with the related directions before you use the telephone function.

Warning

Use of the hands-free facility while driving can be dangerous because your concentration is reduced when telephoning. Park your vehicle before you use the hands-free facility. Follow the stipulations of the country in which you find yourself at present.

Do not forget to follow the special regulations that apply in specific areas and always switch off the mobile phone if the use of mobile phones is prohibited, if

interference is caused by the mobile phone or if dangerous situations can occur.

Pairing a device

During the pairing process, PIN code exchange between the Bluetooth device and the Infotainment system and connection of the Bluetooth devices to the Infotainment system are carried out.

Important information

- Two paired Bluetooth devices can be connected to the Infotainment system at the same time. One device in hands-free mode, the other in audio streaming mode, see description on Bluetooth profile settings below.
However, two devices cannot be used in hands-free mode at the same time.
- Pairing only needs to be carried out once, unless the device is deleted from the list of paired devices. If the device has been

connected previously, the Infotainment system establishes the connection automatically.

- Bluetooth operation considerably drains the device's battery. Therefore, connect the device to the USB port for charging.

Pairing a new device

1. Activate the Bluetooth function of the Bluetooth device. For further information, see the operating instructions for the Bluetooth device.
2. Press  and then touch **Bluetooth search**.

A search for all Bluetooth devices in the near environment is performed.
3. Select the Bluetooth device you wish to pair from the displayed list.
4. Confirm the pairing procedure:
 - If SSP (secure simple pairing) is supported:

Confirm the messages on the Infotainment system and the Bluetooth device.

- If SSP (secure simple pairing) is not supported:

On the Infotainment system: a message is displayed asking you to enter a PIN code on your Bluetooth device.

On the Bluetooth device: enter the PIN code and confirm your input.

The Infotainment system and the device are paired.

5. The phone book is downloaded automatically to the Infotainment system. Depending on the phone, the Infotainment system must be allowed access to the phone book. If required, confirm the messages displayed on the Bluetooth device.

If this function is not supported by the Bluetooth device, a corresponding message is displayed.

Operations on paired devices

Press , select **TEL** and then select **Bluetooth connection**.

A list of all paired devices is displayed.

Changing the Bluetooth profile settings

Touch  next to the desired paired device.

Activate or deactivate the profile settings as desired and confirm your settings.

Connecting a paired device

Devices which are paired but not connected are identified by .



Select the desired device to connect it.

Disconnecting a device

The currently connected device is identified by .

Select the device to disconnect it.

Deleting a paired device

Touch  in the upper right corner of the screen to display  icons next to each paired device.

Touch  next to the Bluetooth device you want to delete and confirm the displayed message.

Climate control

Climate control systems	151
Heating and ventilation system	151
Air conditioning system	152
Electronic climate control system	154
Auxiliary heater	158
Temperature preconditioning . .	158
Air vents	159
Adjustable air vents	159
Fixed air vents	160
Maintenance	160
Air intake	160
Air conditioning regular operation	161
Service	161

Climate control systems

Heating and ventilation system



Controls for:

- temperature (/ \)
- air distribution (windshield, front door/windows, head area, foot well)
- fan speed (fan icon)
- demisting and defrosting (windshield with snowflake icon, MAX)
- heated rear window and exterior mirrors (REAR icon)
- heated seats (seat icon)

Heated rear window ⇨ 24.

Heated exterior mirrors ⇨ 21.

Heated seats ⇨ 30.

Temperature

Adjust the temperature by turning (/ \) to the desired temperature.

red area : warmer
blue area : colder

Heating will not be fully effective until the engine has reached normal operating temperature.

Air distribution

- (windshield and front door/windows icon) : to windscreen and front door windows
- (head area icon) : to head area via adjustable air vents
- (foot well icon) : to foot well and windscreen

All combinations are possible.

Fan speed

Adjust the air flow by turning (fan icon) to the desired speed.

clockwise : increase
anticlockwise : decrease

Demisting and defrosting



- Press : the air distribution is directed towards the windscreen.
- Set temperature controller to warmest level.
- Set fan speed to highest level.
- Switch on heated rear window .
- Open side air vents as required and direct them towards the door windows.

Air conditioning system



Controls for:

- temperature
- air distribution , and
- fan speed
- demisting and defrosting
- cooling **A/C**
- air recirculation
- heated rear window and exterior mirrors
- heated seats

Heated rear window ⇨ 24.

Heated exterior mirrors ⇨ 21.

Heated seats ⇨ 30.

Some setting changes are indicated briefly in the Info Display. Activated functions are indicated by the LED in the respective button.

Temperature

Adjust the temperature by turning to the desired temperature.

red area : warmer
blue area : colder

Heating will not be fully effective until the engine has reached normal operating temperature.

Air distribution

- : to windscreen and front door windows
- : to head area via adjustable air vents
- : to foot well and windscreen

All combinations are possible.

Fan speed

Adjust the air flow by turning to the desired speed.

clockwise : increase
anticlockwise : decrease

Cooling A/C



Press **A/C** to switch on cooling. The LED in the button illuminates to indicate activation. Cooling is only functional when the engine is running and fan is switched on.

Press **A/C** again to switch off cooling. The air conditioning system cools and dehumidifies (dries) as soon as the outside temperature is slightly above the freezing point. Therefore, condensation may form and drip from under the vehicle.

If no cooling or drying is required, switch off the cooling system for fuel saving reasons.

Activated cooling may inhibit Autostops.

Stop-start system ↗ 167.

Air recirculation system



Press  to activate air recirculation mode. The LED in the button illuminates to indicate activation.

Press  again to deactivate air recirculation mode.

Warning



The exchange of fresh air is reduced in air recirculation mode. In operation without cooling the air humidity increases, so the windows may mist up from inside. The quality of the passenger compartment air deteriorates, which may cause the vehicle occupants to feel drowsy.

In warm and very humid ambient air conditions, the windscreen may mist up from outside when cold air is directed towards it. If windscreen mists up from outside, activate windscreen wiper and deactivate .

Maximum cooling



Briefly open the windows so that hot air can disperse quickly.

- Switch on cooling **A/C**.
- Press  for air recirculation system on.
- Press  for air distribution.
- Set temperature control (/ \) to coldest level.
- Set fan speed  to highest level.
- Open all vents.

Heated rear window  24.

Heated exterior mirrors  21.



Demisting and defrosting the windows



- Press  the air distribution is directed towards the windscreen.
- Set temperature controller (/ \) to warmest level.
- Switch on cooling **A/C**, if required.

- Switch on heated rear window .
- Open side air vents as required and direct them towards the door windows.

Notice

If  is pressed while the engine is running, an Autostop will be inhibited until  is pressed again.

If  is pressed while the engine is in an Autostop, the engine will restart automatically.





Stop-start system  167.

Electronic climate control system



Controls for:

- temperature (/ \)
- **MENU** enters the Climate setting menu in the Info Display

- fan speed 
- automatic mode **AUTO**
- cooling **A/C**
- manual air recirculation 
- demisting and defrosting 
- heated rear window and exterior mirrors 
- heated seats 

Heated rear window  24.

Heated exterior mirrors  21.

Heated seats  30.

In automatic mode, temperature, fan speed and air distribution are regulated automatically.



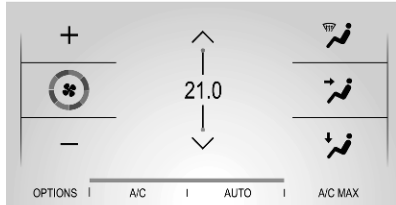

Activated functions are indicated by the LED in the respective control.

The electronic climate control system is only fully operational when the engine is running.

Climate control settings menu



Press **MENU** to manually set the following climate control functions:

- air distribution ,  and 
- fan speed 
- temperature (/ \)
- cooling **A/C**
- automatic mode **AUTO**

Climate setting menu can also be displayed in the Info Display.

Info Display ⇨ 78.

Automatic mode AUTO



Basic setting for maximum comfort:

- Press **AUTO**, the air distribution and fan speed are regulated automatically.

Three different pre-set fan speeds can be selected by repeatedly tapping on **AUTO** either on the climate control panel or on the Info Display: soft, normal or fast. The selected setting is shown on the Info Display.

- Open all air vents to allow optimised air distribution in automatic mode.

- Air conditioning must be activated for optimal cooling and demisting. Press **A/C** to switch on air conditioning. The LED in the button indicates activation.
- Set the preselected temperature using the left or right rotary knob. Recommended temperature is 22 °C.

Manual settings

Climate control system settings can be changed by activating the following functions:

Fan speed



Adjust the air flow by turning rotary knob to the desired speed. Fan speed can also be changed in the climate settings menu. Press **MENU** to enter the menu.

Turn rotary knob anticlockwise as far as it will go: fan and cooling are switched off.

To return to automatic mode, press **AUTO**.

Air distribution

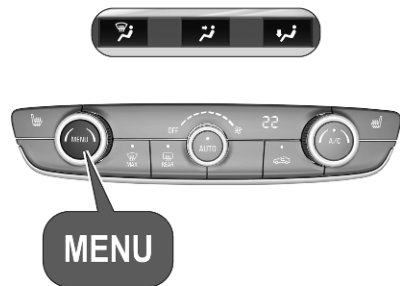

Press **MENU** to enter the menu.

Touch in the Info Display:

- : to windscreen and front door windows
- : to head area and rear seats via adjustable air vents
- : to front and rear foot well and windscreen

To return to automatic air distribution, press **AUTO**.

Temperature preselection



Set the preselected temperature to the desired value using the left or the right rotary knob.

Recommended temperature is 22 °C. The temperature is indicated in the display and in the climate settings menu.

If the minimum temperature **Lo** is set, the climate control system runs at maximum cooling, if cooling **A/C** is switched on.

If the maximum temperature **Hi** is set, the climate control system runs at maximum heating.

Notice

If **A/C** is switched on, reducing the set cabin temperature can cause the engine to restart from an Autostop or inhibit an Autostop.

Stop-start system ⇨ 167.

Air conditioning **A/C**

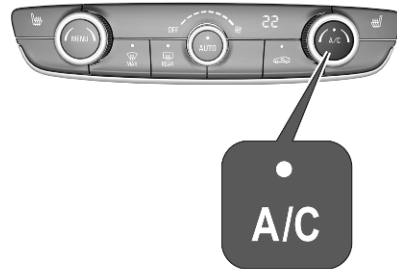

Press **A/C** to switch on cooling. The LED in the button illuminates to indicate activation. Cooling is only functional when the engine is running and climate control fan is switched on.

Press **A/C** again to switch off cooling. The air conditioning system cools and dehumidifies (dries) when outside temperature is above a specific level. Therefore, condensation may form and drip from under the vehicle.

If no cooling or drying is required, switch off the cooling system for fuel saving reasons.

Maximum air conditioning AC/MAX

Press **MENU** to enter the climate control settings menu.

Touch **A/C MAX** to activate/deactivate maximum air conditioning.

The maximum air conditioning function sets the temperature as low as possible and adjusts the distribution to all air vents. In addition, it sets the air flow to maximum and activates the air recirculation.

Manual air recirculation

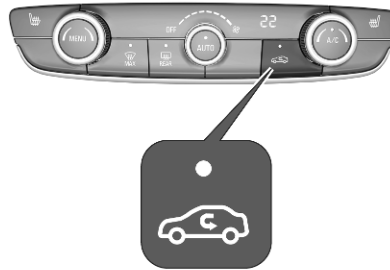

Press  to activate the air recirculation mode. The LED in the button illuminates to indicate activation.

Press  again to deactivate recirculation mode.

Warning

The exchange of fresh air is reduced in air recirculation mode. In operation without cooling, the air humidity increases, so the windows may mist up from inside.



The quality of the passenger compartment air deteriorates, which may cause the occupants to feel drowsy.

In warm and very humid ambient air conditions, the windscreen may mist up from outside, when cold air is directed towards it. If windscreen mists up from outside, activate windscreen wiper and deactivate .

Demisting and defrosting the windows





- Press . The LED in the button illuminates to indicate activation.
- Temperature and air distribution are set automatically and the fan runs at high speed.
- Switch on air conditioning by pressing **A/C**, if required.

- Switch on heated rear window  REAR.
- To return to previous mode, press  again. To return to automatic mode, press **AUTO**.

Heated rear window ⇨ 24.

Heated exterior mirrors ⇨ 21.

Notice

If  is pressed while the engine is running, an Autostop will be inhibited until  is pressed again.

If  is pressed while the engine is in an Autostop, the engine will restart automatically.

Stop-start system ⇨ 167.

Deactivation of electronic climate control system

Cooling, fan and automatic mode can be switched off by turning one of the rotary knobs anticlockwise.

Activation by switching on the fan or pressing **AUTO**.

Auxiliary heater

Air heater

Quickheat is an electric auxiliary air heater which automatically warms up the passenger compartment more quickly.

Temperature preconditioning

The temperature preconditioning allows to heat or to ventilate the vehicle's interior with ambient air.

The temperature preconditioning can be programmed via the Info Display or the MyVauxhall App.

Notice

On vehicles without integrated navigation system, temperature preconditioning can only be used via the MyVauxhall App.

Notice

The temperature preconditioning is only activated if the ignition is off and the vehicle is locked.

If the charging level of the high voltage battery is below 30%, the temperature preconditioning is not activated.

When the vehicle is plugged in, battery charging takes precedence over pre-conditioning.

Consequently, it can only be activated if the battery is charged above a threshold fixed at 80%.

If a recurrent heating / ventilation is programmed and two heating / ventilation procedures are carried out without operating the vehicle, the programming is deactivated.

Setting timer

Notice

Several timers can be programmed and saved. It is recommended to programme temperature preconditioning with the vehicle plugged in, in order to optimise the long-term performance of the high voltage battery.



Press **MENU** .
Touch **OPTIONS**.

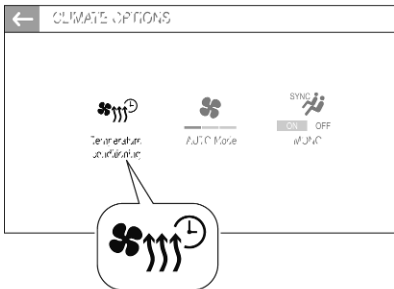

Select .
Touch **+** to define a new timer.
Touch **-:--**.
Enter time and day.
Press **✓** to confirm the settings.
Press **ON** to activate the timer.

To delete a timer, press at the top of the Info Display and delete the desired timer.

Confirm the deletion.

The heating / ventilation procedure starts approx. 45 minutes before the programmed time, and is maintained ten minutes after it.

Air vents

Adjustable air vents

Centre air vents in the instrument panel

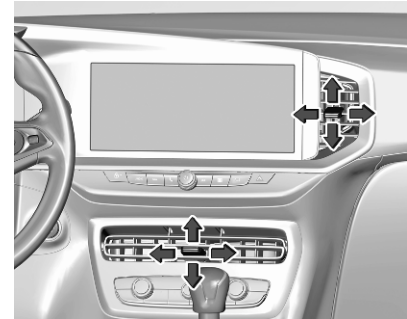

Direct the flow of air by tilting and swivelling the slats.

To close the vent, swivel the slats inwards.

Outer air vents in the instrument panel

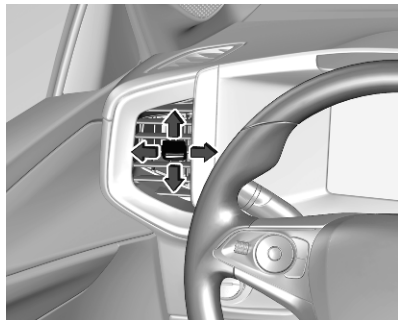

Direct the flow of air by tilting and swivelling the slats.

To close the vent, swivel the slats outwards.

At least two air vents must be open while cooling is on.

Warning

Do not attach any objects to the slats of the air vents. Risk of damage and injury in case of an accident.

Fixed air vents

Additional air vents are located beneath the windscreen and door windows and in the foot wells.

Maintenance

Air intake



The air intake in front of the windscreen in the engine compartment must be kept clear to allow air intake. Remove any leaves, dirt or snow.

Air conditioning regular operation

In order to ensure continuously efficient performance, cooling must be operated for a few minutes once a month, irrespective of the weather and time of year. Operation with cooling is not possible when the outside temperature is too low.

Service

For optimal cooling performance, it is recommended to annually check the climate control system, starting three years after initial vehicle registration, including:

- functionality and pressure test
- heating functionality
- leakage check
- check of drive belts
- cleaning of condenser and evaporator drainage
- performance check

Driving and operating

Driving hints	163
Control of the vehicle	163
Steering	163
Emergencies	163
Starting and operating	164
New vehicle running-in	164
Ignition switch positions	164
Power button	164
Starting the engine	166
Overrun cut-off	167
Stop-start system	167
Parking	170
Engine exhaust	171
Exhaust filter	171
Catalytic converter	171
AdBlue	172
Electric drive unit	175
Automatic transmission	177
Manual transmission	180
Drive systems	181
Drive modes	181

Brakes	182
Antilock brake system	182
Parking brake	183
Brake assist	185
Hill start assist	185
Regenerative braking	185
Ride control systems	186
Electronic Stability Control and Traction Control system	186
Sport mode	187
Driver assistance systems	187
Cruise control	188
Speed limiter	190
Adaptive cruise control	192
Forward collision alert	198
Active emergency braking	200
Automatic post collision braking	204
Front pedestrian protection	204
Parking assist	205
Advanced parking assist	211
Side blind spot alert	216
Rear view camera	217
Traffic sign assistant	220
Lane departure warning	223
Lane keep assist	224
Advanced lane keep assist	226
Driver alert	228

Charging	230
General information	230
Charging types	231
Charging cable	232
Programmable charging	237
Charging status	238
Fuel	239
Fuel for petrol engines	239
Fuel for diesel engines	240
Refuelling	241
Fuel consumption - CO ₂ - Emissions	242
Trailer hitch	243
General information	243
Driving characteristics and towing tips	243
Trailer towing	243

Driving hints

Control of the vehicle

Never coast with engine not running

Many systems will not function in this situation (e.g. brake servo unit, power steering). Driving in this manner is a danger to yourself and others.

All systems function during an Autostop.

Stop-start system ⇨ 167.

Pedals

To ensure the pedal travel is uninhibited, there must be no mats in the area of the pedals.

Use only floor mats, which fit properly and are fixed by the retainers on the driver side.

Steering

If power steering assist is lost because the engine stops or due to a system malfunction, the vehicle can be steered but may require increased effort.

Emergencies

Warning

Damage to the high voltage battery or high voltage system can create a risk of electric shock, overheating, or fire.

If the vehicle has been damaged or affected by a moderate to severe crash, it must be inspected as soon as possible by qualified personnel. Until the technical inspection has been carried out, the vehicle must be stored outside at a minimum distance of 5 metres from any structure or other flammable objects.

If the vehicle has been damaged or affected by flood or fire, it must not be moved at all and has to be inspected by qualified personnel as soon as possible.

Starting and operating

New vehicle running-in

Do not brake unnecessarily hard for the first few journeys.

During the first drive, smoke may occur because of wax and oil evaporating off the exhaust system. Park the vehicle in the open for a while after the first drive and avoid inhaling the fumes.

During the running-in period, fuel and engine oil consumption may be higher.

Additionally, the cleaning process of the exhaust filter may take place more often.

Exhaust filter ↪ 171.

Ignition switch positions

Turn key:

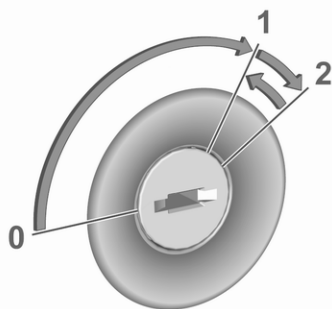

- 0 : ignition off: some functions remain active until key is removed or driver's door is opened, provided the ignition was on previously
- 1 : ignition on power mode: ignition is on, diesel engine is preheating, control indicators illuminate and most electrical functions are operable
- 2 : engine start: release key after engine has been started

Steering wheel lock

Depending on version, the vehicle may be equipped with a steering wheel lock.

In this case, remove key from ignition switch and turn steering wheel until it engages.

⚠ Danger

Never remove the key from ignition switch during driving as this will cause, depending on version, steering wheel lock.

Power button



The electronic key must be inside the vehicle.

Engine start

Operate the clutch pedal (manual transmission), the brake pedal and press **Start/Stop**.

Ignition on power mode without starting the engine

Press **Start/Stop** without operating clutch or brake pedal. Control indicators illuminate and most electrical functions are operable.

Engine and ignition off

Press **Start/Stop** briefly in each mode or when engine is running and vehicle is stationary. Some functions remain active until driver's door is opened, provided the ignition was on previously.

Emergency shut off during driving

Press **Start/Stop** for 5 seconds ↻ 166. Depending on version, steering wheel locks as soon as vehicle is stationary.

Steering wheel lock

Depending on version, the vehicle may be equipped with a steering wheel lock.

In this case, the steering wheel lock activates automatically when:

- the vehicle is stationary.
- the ignition has been switched off.

To release steering wheel lock, open and close driver's door and switch the ignition on power mode or start the engine directly.

⚠ Warning

If the vehicle battery is discharged, the vehicle must not be towed or tow-started as the steering wheel lock cannot be disengaged.

Operation in case of failure

If either the electronic key fails or the battery of the electronic key is weak, a message may be displayed in the Driver Information Centre.

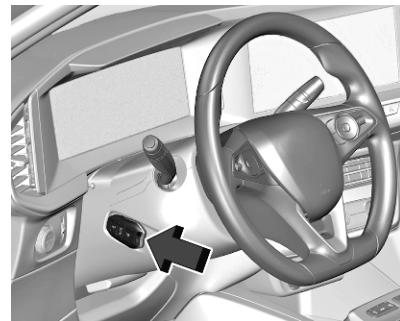

Hold the electronic key at the marking on the steering column cover as shown in the illustration.

On vehicles with manual transmission, select neutral gear, operate the clutch pedal, the brake pedal and press **Start/Stop**.

On vehicles with automatic transmission, set the selector lever to position **P**, operate the brake pedal and press **Start/Stop**.

This option is intended for emergencies only. Replace the electronic key battery as soon as possible ↻ 8.

For unlocking or locking the doors, see fault in radio remote control unit or electronic key system ⇨ 10.

Starting the engine

Vehicles with ignition switch

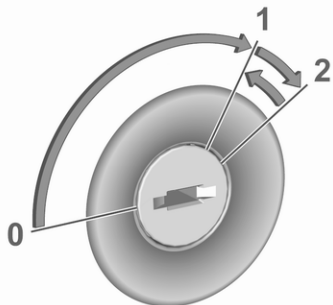

Turn key to position 1 to release the steering wheel lock.

Manual transmission: operate clutch and brake pedal.

Automatic transmission: operate brake pedal.

Do not operate accelerator pedal.

Diesel engines: wait until control indicator  extinguishes.

Turn key briefly to position 2 and release after engine has been started.

Manual transmission: during an Autostop, the engine can be started by depressing the clutch pedal ⇨ 167.

Automatic transmission: during an Autostop, the engine can be started by releasing the brake pedal ⇨ 167.

Vehicles with power button



- Manual transmission: select neutral gear, operate clutch and brake pedal.
- Automatic transmission: operate brake pedal.
- Do not operate accelerator pedal.
- Press **Start/Stop** button.
- Release button after starting procedure begins. Diesel engine starts after control indicator  for preheating extinguishes.
- Before restarting or to switch off the engine when vehicle is stationary, press **Start/Stop** once more briefly.

To start the engine during an Autostop:

- Manual transmission: during an Autostop, the engine can be started by depressing the clutch pedal ⇨ 167.
- Automatic transmission: during an Autostop, the engine can be started by releasing the brake pedal ⇨ 167.

Emergency shut off during driving

If the engine needs to be switched off during driving in case of emergency, press **Start/Stop** for 5 seconds.

Danger

Switching off the engine during driving may cause loss of power support for brake and steering systems. Assistance systems and airbag systems are disabled. Lighting and brake lights will extinguish. Therefore power down the engine and ignition while driving only when required in case of emergency.

Starting the vehicle at low temperatures

Starting the engine without additional heaters is possible down to -25 °C for diesel engines and -30 °C for petrol engines. Required is an engine oil with the correct viscosity, the correct fuel, performed services and a sufficiently charged vehicle battery. With temperatures below -30 °C the automatic transmission requires a warming phase of approx. 5 minutes. The selector lever must be in position **P**.

Turbo engine warm-up

Upon start-up, engine available torque may be limited for a short time, especially when the engine temperature is cold. The limitation is to allow the lubrication system to fully protect the engine.

Overrun cut-off

The fuel supply is automatically cut off during overrun, i.e. when the vehicle is driven with a gear engaged but accelerator pedal is released.

Depending on driving conditions, the overrun cut-off may be deactivated.



Stop-start system

The stop-start system helps to save fuel and to reduce the exhaust emissions. When conditions allow, it switches off the engine as soon as the vehicle is at a low speed or at a standstill, e.g. at a traffic light or in a traffic jam.

Activation

The stop-start system is available as soon as the engine is started, the vehicle starts-off and the conditions as stated below in this section are fulfilled.



The system is ready to operate when the LED in the button  is not illuminated. To activate the system when the system is deactivated, press .

If the stop-start system is temporarily not available and the button  is pressed, the LED in the button flashes.

Deactivation

Deactivate the stop-start system manually by pressing . The deactivation is indicated when the LED in the button illuminates.

Autostop

Vehicles with manual transmission

Activate an Autostop as follows:

- Set the selector lever to neutral.
- Release the clutch pedal.

The engine will be switched off while the ignition stays on.

Vehicles with automatic transmission

If the vehicle is at a standstill with depressed brake pedal, Autostop is activated automatically.

The engine will be switched off while the ignition stays on.

The stop-start system will be disabled on steep inclines.

Indication



An Autostop is indicated by control indicator .

During an Autostop, the heating and brake performance will be maintained.

Conditions for an Autostop

The stop-start system checks if each of the following conditions is fulfilled.

- The stop-start system is not manually deactivated.
- The driver's door is closed or the driver's seat belt is fastened.
- The vehicle battery is sufficiently charged and in good condition.
- The engine is warmed up.
- The engine coolant temperature is not too high.
- The engine exhaust temperature is not too high, e.g. after driving with high engine load.
- The ambient temperature is not too low or too high.
- The climate control system allows an Autostop.
- The brake vacuum is sufficient.

- The self-cleaning function of the exhaust filter is not active.
- The vehicle was driven at least at walking speed since the last Autostop.

Autostop will be inhibited if these conditions are not met. In addition, Autostop may be inhibited

- by certain settings of the climate control system ↪ 152
- immediately after higher speed driving
- in the case of new vehicle running-in ↪ 164
- by active demisting
- in the case of steep ascending or descending slopes

Notice

The Autostop may be inhibited for several hours after a battery replacement or reconnection.

Vehicle battery discharge protection

To ensure reliable engine restarts, several vehicle battery discharge protection features are implemented as part of the stop-start system.

Power saving measures

During an Autostop, several electrical features such as auxiliary electric heater or rear window heating are disabled or switched to a power saving mode. The fan speed of the climate control system is reduced to save power.

Restart of the engine by the driver

Vehicles with manual transmission

Depress the clutch pedal without depressing the brake pedal to restart the engine.

Vehicles with automatic transmission

The engine is restarted in the following cases:

- brake pedal released while **D** or **M** is selected
- brake pedal released or **N** selected when selector is moved to select **D** or **M**
- selector is moved to select **R**

Restart of the engine by the stop-start system

Vehicles with manual transmission: The selector lever must be in neutral to enable an automatic restart.

If one of the following conditions occurs during an Autostop, the engine will be restarted automatically by the stop-start system:

- stop-start system manually deactivated
- driver's seat belt unfastened and driver's door opened
- engine temperature too low
- charging level of vehicle battery below a defined level
- brake vacuum not sufficient
- vehicle is driven or rolls at least at walking speed
- climate control system requests engine start
- air conditioning manually switched on
- the bonnet is opened

If an electrical accessory, e.g. a portable CD player, is connected to the power outlet, a brief power drop during the restart might be noticeable.

Parking

Warning

- Do not park the vehicle on an easily ignitable surface. The high temperature of the exhaust system could ignite the surface.
- Apply the parking brake.
- If the vehicle is on a level surface or uphill slope, engage first gear or set the selector lever to position **P**. On an uphill slope, turn the front wheels away from the kerb.
If the vehicle is on a downhill slope, engage reverse gear or set the selector lever to position **P**. Turn the front wheels towards the kerb.
- Close the windows.

- Switch off the engine.
- Remove the ignition key from the ignition switch or switch off ignition on vehicles with power button. Depending on version, turn the steering wheel until the steering wheel lock is felt to engage.

- Lock the vehicle.
- Activate the anti-theft alarm system.
- The engine cooling fans may run after the engine has been switched off ⇨ 250.

Caution

After running at high engine speeds or with high engine loads, operate the engine briefly at a low load or run in neutral for approx. 30 seconds before switching off, in order to protect the turbocharger.

Notice

In the event of an accident with airbag deployment, the engine is switched off automatically if the vehicle comes to a standstill within a certain time.

In countries with extremely low temperatures it may be necessary to park the vehicle without applied parking brake. Make sure to park the vehicle on a level surface.

Parking brake ⇨ 183.

Engine exhaust

Danger

Engine exhaust gases contain poisonous carbon monoxide, which is colourless and odourless and could be fatal if inhaled.



If exhaust gases enter the interior of the vehicle, open the windows. Have the cause of the fault rectified by a workshop.

Avoid driving with an open load compartment, otherwise exhaust gases could enter the vehicle.

Exhaust filter

Automatic cleaning process

The exhaust filter system filters soot particles out of the exhaust gases.



The start of saturation of the exhaust filter is indicated by the temporary illumination of  or , accompanied by a message in the Driver Information Centre.

As soon as the traffic conditions permit, regenerate the filter by driving at a vehicle speed of at least 40 mph until the control indicator extinguishes.

Notice

On a new vehicle, the first exhaust filter regeneration operations may be accompanied by a burning smell, which is normal. Following prolonged operation of the vehicle at very low speed or at idle, water vapour can be emitted at the exhaust on acceleration. This does not affect the behaviour of the vehicle or the environment.

Cleaning process not possible



If  or  stays on, accompanied by an audible signal and a message, this indicates that the exhaust filter additive level is too low.

The reservoir must be topped-up without delay. Seek the assistance of a workshop.

Catalytic converter

The catalytic converter reduces the amount of harmful substances in the exhaust gases.

Caution

Fuel grades other than those listed on pages  239,  288 could damage the catalytic converter or electronic components.

Unburnt petrol will overheat and damage the catalytic converter. Therefore avoid excessive use of the starter, running the fuel tank dry and starting the engine by pushing or towing.

In the event of misfiring, uneven engine running, a reduction in engine performance or other unusual problems, have the cause of the fault rectified by a workshop as soon as possible. In an emergency, driving can be continued for a short period, keeping vehicle speed and engine speed low.

AdBlue

General information

The selective catalytic reduction (BlueInjection) is a method to substantially reduce the nitrogen oxides in the exhaust emission. This is achieved by injecting a Diesel Exhaust Fluid (DEF) into the exhaust system. The ammonia released by the fluid reacts with nitrous gases (NO_x) from the exhaust and turns it into nitrogen and water.

The designation of this fluid is AdBlue®. It is a non-toxic, non-flammable, colourless and odourless fluid which consists of 32% urea and 68% water.

Warning

Avoid contact of your eyes or skin with AdBlue.

In case of eye or skin contact, rinse off with water.

Caution

Avoid contact of the paintwork with AdBlue.

In case of contact, rinse off with water.

AdBlue freezes at a temperature of approx. -11 °C. As the vehicle is equipped with an AdBlue pre-heater, the emissions reduction at low temperatures is ensured. The AdBlue pre-heater works automatically.

In some circumstances below the mentioned temperature, an error message appears in the Driver Information Centre. In this event, park the vehicle in a space with a higher ambient temperature until AdBlue is liquefied.

Notice

Frozen and again liquefied AdBlue is usable without quality loss.

The typical AdBlue consumption is approx. 2 l per 600 miles, but can also be higher depending on driving behaviour (e.g. high load or towing).

Level warnings

Depending on the calculated range of AdBlue, different messages are displayed in the Driver Information Centre. The messages and the restrictions are a legal requirement.

1. The first warning level is entered when the estimated AdBlue range is between 1500 miles and 500 miles.

When switching on the ignition, this warning will show up once briefly with the calculated range. Additionally, control indicator  will illuminate and a chime will sound. Driving is possible without any restrictions.

2. The next warning level is entered when the estimated AdBlue range is below 500 miles. The message with the current range will always be displayed when ignition is switched on. Additionally, control indicator  will flash and a chime will sound. Refill AdBlue before entering the next warning level.

3. The next warning level is entered with a range below 60 miles. The message with the current range will always be displayed when ignition is switched on. Additionally, control indicator  will flash and a chime will sound. Refill AdBlue as soon as possible before the AdBlue tank is completely empty. Otherwise, a restart of the engine will not be possible.



4. The last warning level is entered when the AdBlue tank is empty. Restart of the engine is not possible.

A message appears in the Driver Information Centre. Additionally, control indicator  will flash and a chime will sound.

Refill the tank to a level of at least 5 l of AdBlue, otherwise restarting of the engine is not possible.

High emission warnings

In the event of a fault with the emissions control system, different messages are displayed in the Driver Information Centre.

The messages and the restrictions are a legal requirement. The warning messages are accompanied by the control indicators ,  and . Additionally, a chime will sound.

Follow the instructions of the warning messages. If starting is prevented, seek the assistance of a workshop.

Refilling AdBlue

Caution

Only use AdBlue that complies with European standards DIN 70 070 and ISO 22241-1.

Do not use additives.

Do not dilute AdBlue.

Otherwise the selective catalytic reduction system could be damaged.

Notice

Whenever a filling pump with a nozzle for passenger cars is not available at a filling station, use only AdBlue bottles or canisters with a sealed refill adapter for refilling, to prevent splashback and overspill,

and in order to ensure that the fumes from the tank are captured and do not emerge. AdBlue in bottles or canisters is available in many filling stations and can be purchased e.g. at Vauxhall dealers and other retail outlets.

Since AdBlue has a limited durability, check the date of expiry before refilling.

Notice

Refill the AdBlue tank to a level of at least 10 l, to ensure that the new AdBlue level is being detected.

In case AdBlue refill is not successfully detected:

1. Continuously drive the vehicle for ten minutes making sure that vehicle speed is always higher than 12 mph.
2. If AdBlue refill is detected successfully, AdBlue supply-driven warnings or limitations will disappear.

If AdBlue refill is still not detected, seek the assistance of a workshop.

If AdBlue must be refilled at temperatures below -11 °C, the refilling of AdBlue may not be detected by the system. In this event, park the vehicle in a space with a higher ambient temperature until AdBlue is liquified.

Notice

When unscrewing the protective cap from the filler neck, ammonia fumes may emerge. Do not inhale as the fumes have a pungent smell. The fumes are not harmful by inhalation.

The AdBlue tank should be filled completely. This must be done if the warning message regarding prevention of an engine restart is already displayed.

AdBlue refilling quantity ⇨ 290.

The vehicle must be parked on a level surface.

The filler neck for AdBlue is located behind the fuel filler flap.

The fuel filler flap can only be opened if the vehicle is unlocked.

1. Switch off the ignition.

2. Close all doors to avoid ammonia fumes entering the interior of the vehicle.
3. Release the fuel filler flap by pushing the flap ⇨ 241.

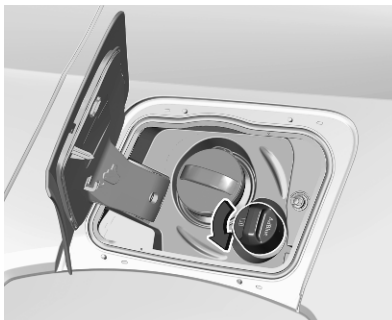

4. Unscrew protective cap from the filler neck.
5. Open AdBlue canister.
6. Mount one end of the hose on the canister and screw the other end on the filler neck.
7. Lift the canister until it is empty, or until the flow from the canister has stopped.

8. Place the canister on the ground to empty the hose, wait 15 seconds.
9. Unscrew the hose from the filler neck.
10. Mount the protective cap and turn clockwise until it engages.

Notice

Dispose of AdBlue canister according to environmental requirements. Hose can be reused after flushing with clear water before AdBlue dries out.

Electric drive unit

Caution

If the vehicle seems to accelerate slowly or not respond when you try to go faster, do not continue your journey. The electric drive unit could be damaged. Consult a workshop as soon as possible.

Caution

Spinning the tyres or holding the vehicle in one place on a hill using only the accelerator pedal may damage the electric drive unit. If you are stuck, do not spin the tyres. When stopping on a hill, use the brakes to hold the vehicle in place.

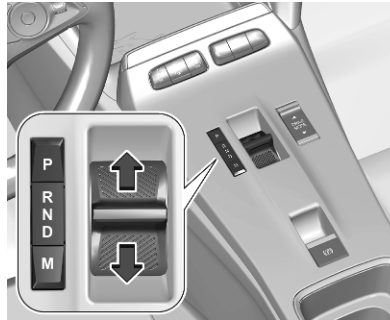

The vehicle uses an electric drive unit with a 1-gear transmission. The selector is located on the centre console between the seats.

- P** : park position
- R** : reverse gear
- N** : neutral
- D** : automatic mode
- B** : automatic mode with one-pedal driving

After selecting a mode, the selector will return to the centre position. The selected mode is indicated in the Driver Information Centre.

Do not accelerate while engaging a mode. Never depress the accelerator pedal and brake pedal at the same time.

When **D** or **R** is selected, the vehicle slowly begins to creep when the brake is released.

Park position P

Warning

Do not leave the vehicle when the propulsion system is running, the vehicle may move suddenly. You or others can be injured. To be sure the vehicle will not move, even if you are on even ground, make sure the parking brake is applied and **P** is selected.

To shift into **P**, press button **P** when vehicle is stationary. In **P**, the front wheels of the vehicle are blocked.

To shift out of **P**, depress the brake pedal and select the desired mode.

The vehicle shifts automatically into **P** when

- the ignition is switched off
- the driver's door is opened while the vehicle's speed is below 1 mph

The vehicle will not shift into **P** if it is moving too fast. Stop the vehicle and shift into **P**.

Reverse gear R

To shift into and out of **R**, the vehicle must be at standstill and the brake pedal has to be depressed.

Caution

Shifting into **R** while the vehicle is moving forwards could damage the electric drive unit. Only shift into **R** after the vehicle has been stopped.

Neutral N

In this position, the propulsion system does not transfer torque to the wheels.

Automatic mode D

This mode is for normal driving.

To shift into and out of **D**, the vehicle must be at standstill and the brake pedal has to be depressed.

Automatic mode B with one-pedal driving

In this mode, vehicle speed is significantly reduced by releasing the accelerator pedal, without operating the brake pedal.

Use **B** when driving down steep hills, in deep snow, in mud or in stop-and-go traffic.

Warning

In the case of extreme temperatures or if the high voltage battery is almost fully charged, the brake force of the engine braking may be temporarily reduced. If the braking force is not sufficient, the driver has to be prepared to use the brake pedal.



Press button **B**.

To deactivate **B**, press button **B**.

Regenerative braking ↻ 185.

Free wheeling / car wash mode

In certain situations, e.g., in an automatic car wash etc., it is necessary that the wheels can move freely when the engine is switched off.

To avoid that the vehicle shifts automatically from **N** into **P**, enable free wheeling:

With the vehicle stationary and the engine running, proceed as follows:

1. Depress the brake pedal and select **N**.
2. Within 5 seconds, depress and hold the brake pedal, switch off ignition and move the selector forwards or backwards.
3. Release the brake pedal and switch on ignition.
4. Depress and hold the brake pedal and push the switch (P).
5. Release the brake pedal and switch off ignition.

A message is displayed in the Driver Information Centre indicating that the wheels are unblocked for the next 15 minutes.

To revert to normal operation, depress the brake pedal, switch on the engine and select **P**.

Parking brake ⇨ 183.

Automatic transmission

The automatic transmission permits automatic gearshifting (automatic mode) or manual gearshifting (manual mode).

Selector operation

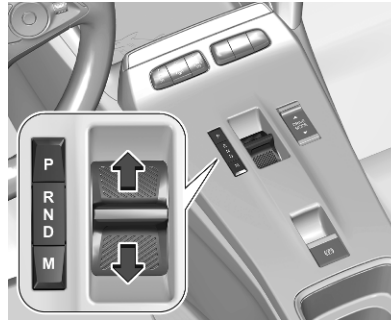

- P** : park position
R : reverse gear
N : neutral
D : automatic mode
M : manual mode

After selecting a mode, the selector will return to the centre position. The selected mode is indicated in the Driver Information Centre.

Do not accelerate while engaging a mode. Never depress the accelerator pedal and brake pedal at the same time.

When **D** or **R** is selected, the vehicle slowly begins to creep when the brake is released.

Park position P

Warning

Do not leave the vehicle when the propulsion system is running, the vehicle may move suddenly. You or others can be injured. To be sure the vehicle will not move, even if you are on even ground, make sure the parking brake is applied and **P** is selected.

To shift into **P**, press button **P** when vehicle is stationary. In **P**, the front wheels of the vehicle are blocked.

To shift out of **P**, depress the brake pedal and select the desired mode.

The vehicle shifts automatically into **P** when

- the ignition is switched off
- the driver's door is opened while the vehicle's speed is below 1 mph

The vehicle will not shift into **P** if it is moving too fast. Stop the vehicle and shift into **P**.

Reverse gear **R**

To shift into and out of **R**, the vehicle must be at standstill and the brake pedal has to be depressed.

Caution

Shifting into **R** while the vehicle is moving forward could damage the automatic transmission. Only shift into **R** after the vehicle has been stopped.

Neutral **N**

In this position, the propulsion system does not transfer torque to the wheels.

When **N** is selected and ignition is switched off, **P** is engaged after a short time.

Automatic mode **D**

This mode is for normal driving.

To shift into and out of **D**, the vehicle must be at standstill and the brake pedal has to be depressed.

Engine braking

To utilise the engine braking effect, select a lower gear in good time when driving downhill.

Free wheeling / car wash mode

In certain situations, e.g., in an automatic car wash etc., it is necessary that the wheels can move freely when the engine is switched off.

To avoid that the vehicle shifts automatically from **N** into **P**, enable free wheeling:

With the vehicle stationary and the engine running, proceed as follows:

1. Depress the brake pedal and select **N**.
2. Within 5 seconds, depress and hold the brake pedal, switch off ignition and move the selector forwards or backwards.
3. Release the brake pedal and switch on ignition.
4. Depress and hold the brake pedal and push the switch (Ⓟ).
5. Release the brake pedal and switch off ignition.

A message is displayed in the Driver Information Centre indicating that the wheels are unblocked for the next 15 minutes.

To revert to normal operation, depress the brake pedal, switch on the engine and select **P**.

Parking brake ⇨ 183.

Deactivation of the automatic operation of the electric parking brake

For this procedure, refer to the description of the automatic parking brake.

Parking brake ⇨ 183

Manual mode

Manual mode **M** can be activated from position **D** in each driving situation and speed.

The selected gear is indicated in the Driver Information Centre.

If a higher gear is selected when vehicle speed is too low, or a lower gear when vehicle speed is too high, the shift is not executed. This can cause a message in the Driver Information Centre.

In manual mode, no automatic shifting to a higher gear takes place at high engine revolutions.

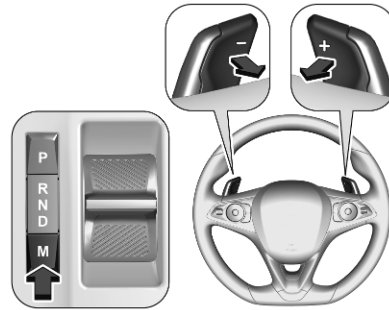

Press button **M**.

Pull steering wheel paddles to select gears manually.

Pull right paddle **+** to shift to a higher gear.

Pull left paddle **-** to shift to a lower gear.

Multiple pulls allow gears to be skipped.

Gear shift indication

The symbol ▲ or ▼ with a number beside it is indicated when gearshifting is recommended for fuel saving reasons.

Shift indication appears only in manual mode.

Engine braking

To utilise the engine braking effect, select a lower gear in good time when driving downhill.

Electronic driving programmes

Following a cold start, the operating temperature programme increases engine speed to quickly bring the catalytic converter to the required temperature.

Special programmes automatically adapt the shifting points when driving up inclines or down hills.

In snowy or icy conditions or on other slippery surfaces, the electronic transmission control enables the driver to select manually first, second or third gear for starting off.

Kickdown

Pressing down the accelerator pedal beyond the kickdown detent will lead to maximum acceleration independent of selected driving

mode. The transmission shifts to a lower gear depending on engine speed.

Fault

In the event of a fault,  illuminates a message is displayed in the Driver Information Centre.

Vehicle messages ⇨ 80.

Electronic transmission control enables only third gear. The transmission no longer shifts automatically.

Do not drive faster than 62 mph.

Have the cause of the fault remedied by a workshop.

Interruption of power supply

In the event of an interruption of power supply, it is not possible to select another mode when **P** is selected.

Towing the vehicle ⇨ 274.

If the vehicle battery is discharged, start the vehicle using jump leads ⇨ 273.

If the vehicle battery is not the cause of the fault, seek the assistance of a workshop.

Manual transmission



To engage reverse, depress the clutch pedal, pull the ring under the selector lever and move the selector lever quite to the left and front.

If the gear does not engage, set the selector lever to neutral, release the clutch pedal and depress again. Then repeat gear selection.

Do not slip the clutch unnecessarily.

When operating, depress the clutch pedal completely. Do not use the pedal as a foot rest.

When clutch slip is detected for a specific time, the engine power will be reduced. A warning is displayed in the Driver Information Centre. Release the clutch.

Caution

It is not advisable to drive with the hand resting on the selector lever.

Gear shift indication ⇨ 72.

Stop-start system ⇨ 167.

Drive systems

Drive modes

Following drive modes are selectable:

- **Normal mode**
- **Sport mode**
- **Eco mode**

Each drive mode corresponds to a different vehicle setting.

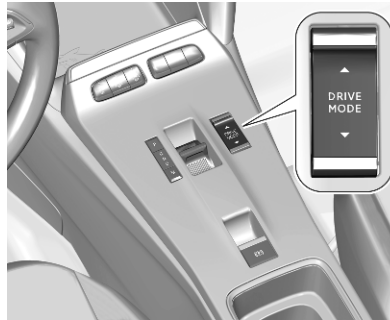

To select the respective drive mode, use the shown toggle switch.

Normal mode

The settings in this mode are set by default. Everytime the ignition is switched on, this mode is selected.

BEV: To optimise range, electric engine power output is reduced.

Sport mode

The settings in this mode allow more dynamic driving. The vehicle's dynamic parameters can be displayed in the Driver Information Centre.

BEV: This mode allows maximum electric engine power output.

Eco mode

Reduces fuel consumption by optimising the operation of the heating and air conditioning and, depending on version, the accelerator pedal, the automatic transmission and the gear shifting indicator.

While coasting the vehicle, the engine is idling with reduced engine brake.

BEV: To optimise range, electric engine power output is reduced and heating is switched off.

Propulsion types ⇨ 4.

Brakes

Antilock brake system

Antilock brake system (ABS) prevents the wheels from locking.

ABS starts to regulate brake pressure as soon as a wheel shows a tendency to lock. The vehicle remains steerable, even during hard braking.

ABS control is made apparent through a pulse in the brake pedal and the noise of the regulation process.

For optimum braking, keep the brake pedal fully depressed throughout the braking process, despite the fact that the pedal is pulsating. Do not reduce the pressure on the pedal.

When braking in an emergency, the hazard warning flashers are switched on automatically depending on the force of deceleration. They are switched off automatically the first time you accelerate.

After starting off, the system performs a self-test which may be audible.



Control indicator  ⇨ 72.

Fault

Warning

If there is a fault in the ABS, the wheels may be liable to lock due to braking that is heavier than normal. The advantages of ABS are no longer available. During hard braking, the vehicle can no longer be steered and may swerve.

Have the cause of the fault remedied by a workshop.

Parking brake

⚠ Warning

Before leaving the vehicle, check parking brake status. Control indicator (P) illuminate constantly when electric parking brake is applied.



Applying when vehicle is stationary

⚠ Warning

Pull switch (P) for a minimum of 1 second until control indicator (P) illuminates constantly and electric parking brake is applied. The electric parking brake operates automatically with adequate force.

Before leaving the vehicle, check the electric parking brake status.

Control indicator (P) → 71.

The electric parking brake can always be activated, even if the ignition is off.

Do not operate electric parking brake system too often without engine running as this will discharge the vehicle battery.

Releasing

Switch on ignition. Keep foot brake pedal depressed and then push switch (P).

Drive away function

Vehicles with manual transmission: Depressing the clutch pedal and then slightly releasing the clutch pedal and slightly depressing the accelerator pedal releases the electric parking brake automatically. This is only possible if the automatic operation of the electric parking brake is activated. It is not possible when switch (P) is pulled at the same time.

Vehicles with automatic transmission: Engaging **R**, **D** or **M** and then depressing the accelerator pedal releases the electric parking brake automatically. This is only possible if the automatic operation of the electric parking brake is activated. It is not possible when switch (P) is pulled at the same time.

Braking when vehicle is moving

When the vehicle is moving and the switch (P) is kept pulled, the electric parking brake system will decelerate the vehicle. As soon as the switch (P) is released, braking will be stopped.

The antilock brake system and the Electronic Stability Control stabilise the vehicle while the switch (P) is kept pulled. If an error of the electric parking brake occurs, a warning message is displayed in the driver information centre. If the antilock brake system and the Electronic Stability Control fail, one or both indicators (ABS) and  illuminate in the Driver Information Centre. In this case, stability during deceleration of the vehicle can only be maintained with repeated short pulls of the switch until the vehicle is immobilised.

Automatic operation

Automatic operation includes automatic application and automatic release of the electric parking brake.

The electric parking brake can also be applied or released manually by using the switch (P).

Automatic application:

- The electric parking brake is automatically applied when the vehicle is stationary and the ignition is switched off.
- (P) illuminates in the Driver Information Centre and a display message pops up to confirm the application.

Automatic release:

Notice

The automatic release of the electric parking brake is inhibited as long as the driver's door is open.

- Parking brake releases automatically on driving off.
- (P) extinguishes in the Driver Information Centre and a display message pops up to confirm the release.

Deactivation of automatic operation

In certain situations, e.g. in extreme cold weather conditions or when towing, it may be necessary to deactivate the automatic operation of the electric parking brake.

1. Start the engine.
2. If the parking brake is released, pull the switch (P) to apply the parking brake.
3. Take your foot off the brake pedal.
4. Press the switch (P) for at least 10 seconds and maximum 15 seconds.
5. Release the switch (P).
6. Depress and hold the brake pedal.
7. Pull the switch (P) for 2 seconds.

The deactivation of the automatic operation of the electric parking brake is confirmed by  illuminating in the Driver Information Centre. The electric parking brake can only be applied and released manually.

The deactivation of the automatic operation of the electric parking brake is confirmed by  illuminating in the Driver Information Centre ⇨ 72. The electric parking brake can only be applied and released manually.

To reactivate the automatic operation, repeat the steps described above.

Fault

Failure mode of electric parking brake is indicated by a control indicator  and by a message displayed in the Driver Information Centre.

Vehicle messages ⇨ 80.

Control indicator  flashes: electric parking brake is not fully applied or released. When continuously flashing, release electric parking brake and retry applying.

Brake assist

If brake pedal is depressed quickly and forcefully, maximum brake force is automatically applied.

Operation of brake assist might become apparent by a pulse in the brake pedal and a greater resistance when depressing the brake pedal.

Maintain steady pressure on the brake pedal as long as full braking is required. Maximum brake force is automatically reduced when brake pedal is released.

Hill start assist

The system helps prevent unintended movement when driving away on inclines.

When releasing the brake pedal after stopping on an incline and certain slope conditions are met, brakes remain on for further 2 seconds. The brakes release automatically as soon as the vehicle begins to accelerate.

Regenerative braking

Warning

In the case of extreme temperatures or if the high voltage battery is almost fully charged, the brake force of the engine braking may be temporarily reduced. If the braking force is not sufficient, the driver has to be prepared to use the brake pedal.

Warning

Depending on the engine braking force the brake lights are illuminated.

Regenerative braking generates electrical energy resulting from engine braking to charge the high voltage battery.

Electric drive unit ⇨ 175.

Ride control systems

Electronic Stability Control and Traction Control system

Electronic Stability Control improves driving stability when necessary, regardless of the type of road surface or tyre grip.

As soon as the vehicle starts to swerve (understeer / oversteer), engine output is reduced and the wheels are braked individually.

Electronic Stability Control operates in combination with the Traction Control system. It prevents the driven wheels from spinning.

The Traction Control system is a component of the Electronic Stability Control.

The Traction Control system improves driving stability when necessary, regardless of the type of road surface or tyre grip, by preventing the driven wheels from spinning.

As soon as the driven wheels starts to spin, engine output is reduced and the wheel spinning the most is braked individually. This considerably improves the driving stability of the vehicle on slippery road surfaces.



Electronic Stability Control and the Traction Control system are operational after each engine start as soon as the control indicator  extinguishes.

When Electronic Stability Control or the Traction Control system operates,  flashes.

When Electronic Stability Control or the Traction Control system is not operational,  illuminates accompanied by a message in the Driver Information Centre.

After reconnecting the vehicle battery, the system needs a recalibration by driving a short distance.

Warning

Do not let this special safety feature tempt you into taking risks when driving.

Adapt speed to the road conditions.

Control indicator   73.

Deactivation

The Traction Control system can be deactivated in the Info Display. Info Display  78.

Deactivation is confirmed by a message in the Driver Information Centre.

Fault

If there is a fault in the system, the control indicator  illuminates continuously, a message appears in

the Driver Information Centre and a warning chime sounds. The system is not operational.

Have the cause of the fault remedied by a workshop.

Sport mode



Sport mode adapts the settings of some vehicle systems to a sportier driving style:

- The engine reacts more quickly to accelerator pedal changes.
- Steering support is sportier.

Activation

Press **SPORT** when engine is running.

The LED in the button illuminates when sport mode is active.

Deactivation

Press **SPORT**. The LED in the button extinguishes when sport mode is deactivated.

Driver assistance systems

⚠ Warning

Driver assistance systems are developed to support the driver and not to replace the driver's attention.

The driver accepts full responsibility when driving the vehicle.

When using driver assistance systems, always take care regarding the current traffic situation.

⚠ Warning

The usage of a license plate support on the front bumper may affect the proper radar unit functionality.

When using a license plate support, follow the markings and indications on the front bumper.

Cruise control

The cruise control can store and maintain speeds above 25 mph. Additionally, at least the third gear must be engaged on some manual transmissions. On automatic transmission, position **D** or the second or a higher gear in position **M** must be selected.

Deviations from the stored speeds may occur when driving uphill or downhill.

The system maintains the vehicle speed at the preset speed by the driver, without any action on the accelerator pedal.

The preset speed can be exceeded temporarily by pressing the accelerator pedal firmly.

The status and preset speed is displayed in the Driver Information Centre.

Do not use the cruise control if it is not advisable to maintain a constant speed.

Switching on the system

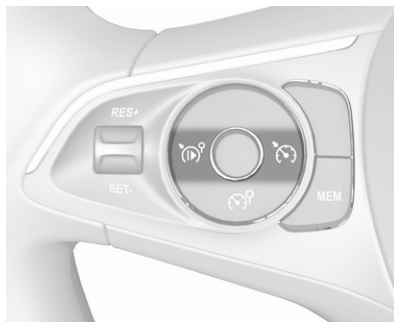

Press .

Symbol  and a message are displayed in the Driver Information Centre. The system is still not active.

Activation of the functionality

Setting speed by the driver

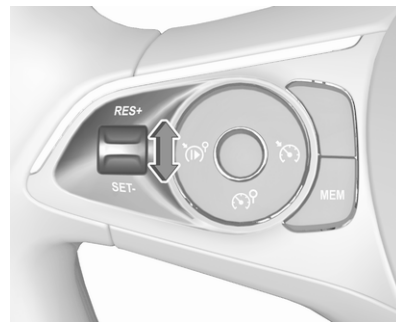

Accelerate to the desired speed and move thumb wheel once briefly to **SET/-**. The current speed is stored and maintained. Accelerator pedal can be released.

The preset speed can then be changed by moving thumb wheel to **RES/+** to increase or **SET/-** to decrease the speed. Move thumb wheel repeatedly to change speed in small steps, move and hold to change speed in large steps.

Speed value is indicated in the Driver Information Centre.

Adopting speed by the speed limit recognition

A detected speed limit can be used as new value for the cruise control.

If the cruise control is active, **MEM** illuminates if the difference between set speed and speed limit is more than 6 mph.

Press **MEM** on the steering wheel to request saving of the suggested speed.

Press **MEM** on the steering wheel once more to confirm and save the new speed setting.

The function can be activated or deactivated in the vehicle personalisation ↻ 81.

Traffic sign assistant ↻ 220.

Exceeding the set speed

Vehicle speed can be increased by depressing the accelerator pedal. When the accelerator pedal is released, the previously stored speed is resumed.

Deactivation of the functionality

Press , cruise control is in pause mode and a message is displayed. The vehicle is driven without cruise control.

Cruise control is deactivated, but not switched off. Last stored speed remains in memory for later speed resume.

Cruise control is deactivated automatically in the following cases:

- The brake pedal is depressed.
- Vehicle speed is below 25 mph.
- The traction control system or electronic stability control is operating.
- The selector lever is in **N** (automatic transmission) or the first or second gear (on some manual transmissions) is engaged.
- The clutch pedal has been depressed for a few seconds (depending on the manual transmission).

Resume stored speed

Move thumb wheel to **RES/+** at a speed above 25 mph. The stored speed will be obtained.

Switching off the system

Press , the cruise control mode is deselected and the cruise control indication extinguishes in the Driver Information Centre.

Pressing  to activate the speed limiter deactivates cruise control.

Switching off the ignition cancels any programmed speed value.

Fault

In the event of a cruise control fault, the speed is cleared resulting in flashing of the dashes.

The speed limit recognition may not operate correctly if traffic signs do not comply with the Vienna Convention on Road Signs and Signals.

Speed limiter

The speed limiter prevents the vehicle from exceeding a preset maximum speed.

The maximum speed can be set at speeds above 18 mph.

The driver can accelerate the vehicle up to the preset speed. Deviations from the limited speed may occur when driving downhill.

The preset speed can be exceeded temporarily by pressing the accelerator pedal firmly.

The status and preset speed limit are displayed in the Driver Information Centre.

Switching on the system

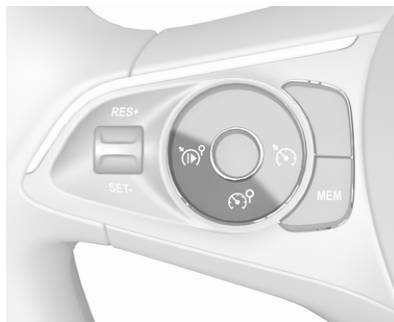

Press .

 and a message are displayed in the Driver Information Centre. The system is still not active.

Activation of the functionality

Setting speed by the driver

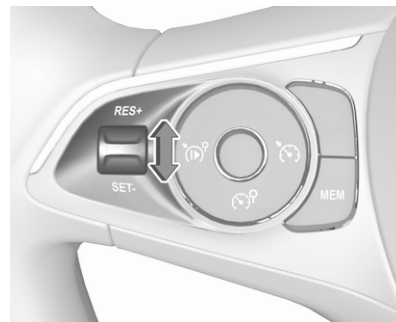

The preset maximum speed can be set by pressing thumb wheel to **RES/+** to increase or **SET/-** to decrease the desired maximum speed. Move thumb wheel repeatedly to change speed in small steps, move and hold to change speed in large steps.

Speed value is indicated in the Driver Information Centre.

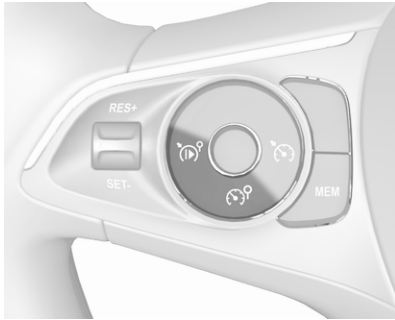

Press  to activate speed limiter.

Adopting speed by the speed limit recognition

A detected speed limit can be used as new value for the speed limiter.

If the speed limiter is active, **MEM** illuminates if the difference between set speed and speed limit is more than 6 mph.

Press **MEM** on the steering wheel to request saving of the suggested speed limit.

Press **MEM** on the steering wheel once more to confirm and save the new speed setting.

The function can be activated or deactivated in the vehicle personalisation  81.

Traffic sign assistant  220.

Exceeding the speed limit

In the event of an emergency, it is possible to exceed the speed limit by depressing the accelerator pedal firmly to the final point. In this case, the preset speed value flashes.

Release the accelerator pedal and the speed limiter function is reactivated once a speed lower than the limit speed is obtained.

Deactivation of the functionality

Press , speed limiter is in pause mode and a message is displayed. The vehicle is driven without speed limiter.

Speed limiter is deactivated, but not switched off. Last stored speed remains in memory for later speed resume.

Resume limit speed

Press , the stored speed limit will be obtained.

Switching off the system

Press , the speed limiter mode is deselected and the speed limit indication extinguishes in the Driver Information Centre.

Pressing  to activate cruise control deactivates speed limiter.

The preset speed remains in the memory when the ignition is switched off.

Fault

In the event of a speed limiter fault, the speed is cleared resulting in flashing of the dashes.

The speed limit recognition may not operate correctly if traffic signs do not comply with the Vienna Convention on Road Signs and Signals.

Adaptive cruise control

The adaptive cruise control is an enhancement of the cruise control with the additional feature of maintaining a certain following distance to the vehicle ahead.



It uses radar and camera sensors to detect the vehicles ahead. If no vehicle is detected in the driving path, the adaptive cruise control will behave like a conventional cruise control.

The adaptive cruise control automatically decelerates the vehicle when approaching a slower moving vehicle. It then adjusts the vehicle speed to follow the vehicle ahead at the selected following distance. The vehicle speed increases or decreases to follow the vehicle ahead, but will

not exceed the set speed. It may apply limited braking with activated brake lights.

If the vehicle ahead accelerates or changes lane, the adaptive cruise control progressively accelerates the vehicle to return to the stored set speed. If the driver operates the turn lights to overtake a slower vehicle, the adaptive cruise control allows the vehicle to temporarily approach the vehicle ahead to help passing it. However, the set speed will never be exceeded.

The adaptive cruise control can store set speeds over 18 mph for manual transmission. If the vehicle ahead is moving too slowly and the selected following distance cannot be maintained anymore, a warning chime is given and a message is displayed in the Driver Information Centre. The message prompts the driver to take back control of the vehicle. On vehicles with automatic transmission, the system can brake the vehicle until a full stop. Depending on variant, the system can automatically accelerate the vehicle after a full stop.

Warning

The complete driver attention is always required while driving with adaptive cruise control. The driver stays fully in control of the vehicle because the brake pedal, the accelerator pedal and the button  have priority over any adaptive cruise control operation.

Switching on the system

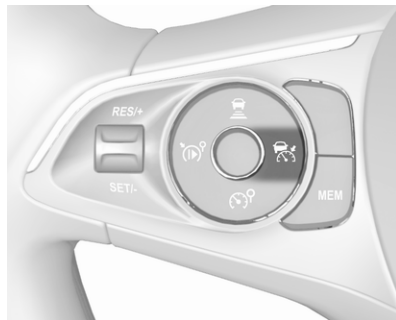

Press .

 is indicated in the Driver Information Centre. The system is still not active.

Activation of the functionality

Setting speed by the driver

The adaptive cruise control has to be switched on manually at a speed between 18 mph and 112 mph. For vehicles with automatic transmission, the automatic selector lever must be in position **D** or **M**.

Accelerate to the desired speed and move the thumb wheel to **SET/-**. The current speed is stored and maintained.

The speed value is indicated in the Driver Information Centre.

The preset speed can then be changed by moving thumb wheel to **RES/+** to increase or **SET/-** to decrease the speed. Move thumb wheel repeatedly to change speed in small steps, move and hold to change speed in large steps.

When the adaptive cruise control is operating, the stop-start system is automatically deactivated.

Adopting speed by the speed limit recognition

A detected speed limit can be used as new value for the adaptive cruise control.

If the adaptive cruise control is active, **MEM** illuminates if the difference between set speed and speed limit is more than 6 mph.

Press **MEM** on the steering wheel to request saving of the suggested speed.

Press **MEM** on the steering wheel once more to confirm and save the new speed setting.

The function can be activated or deactivated in the vehicle personalisation ↻ 81.

Traffic sign assistant ↻ 220.

Overriding set speed

It is always possible to drive faster than the selected set speed by depressing the accelerator pedal. When the accelerator pedal is released, the vehicle returns to the stored speed. If a slower moving

vehicle is ahead, the following distance selected by the driver is restored.

If the set speed is exceeded, the indicated speed setting disappears and a warning message is displayed.

Warning

Accelerating by the driver deactivates automatic braking by the system. This is indicated as a pop-up warning in the Driver Information Centre.

Resuming stored speed

Move the thumb wheel to **RES/+** at a speed above 25 mph. The adaptive cruise control is activated with the stored set speed.

Adaptive cruise control on vehicles with automatic transmission

For vehicles with automatic transmission, adaptive cruise control allows to maintain the selected distance behind a braking vehicle until a complete stop is reached.

If the system has stopped your vehicle behind another vehicle, then the set speed is replaced by a green control indicator (A). This symbol notifies, that the vehicle is hold automatically in stop position.

When the vehicle ahead drives away within some seconds and the traffic conditions allow a restart of the vehicle, then active cruise control is resumed automatically.

If the stopped vehicle ahead was stopped for a longer time and then begins to move forward, the green control indicator (A) will flash and a warning chime will sound as a reminder to check traffic before resuming.

When the vehicle ahead drives away, depress the accelerator pedal or press  to resume adaptive cruise control.

If the vehicle stays stopped for more than 5 minutes or if the driver's door is opened and the driver's seat belt is unfastened, then the electric parking brake is applied automatically to hold the vehicle. Control indicator (P) will illuminate. To release electric parking brake, press the accelerator pedal.

Electric parking brake ⇨ 183.

Warning

When the system is deactivated or cancelled, the vehicle will no longer be held at a stop and can start moving. Be always prepared to manually apply the brake to hold the vehicle stationary.

Do not leave the vehicle while it is being held at a stop by adaptive cruise control. Always move selector lever to park position **P** and switch off the ignition before leaving the vehicle.

Setting the following distance

When adaptive cruise control detects a slower moving vehicle in the driving path, it will adjust the vehicle speed to maintain the following distance selected by the driver.

The following distance can be set to close (1 bar), normal (2 bars) or far (3 bars).

If the engine is running and the adaptive cruise control is enabled (grey) or active (green), you can modify the following distance setting:

Press , the current setting is shown in the Driver Information Centre.



Press  again to change the following distance: The new setting is displayed in the Driver Information Centre.

The selected following distance is indicated by full bars in the adaptive cruise control page.

⚠ Warning

The driver accepts full responsibility for the appropriate following distance based on traffic, weather and visibility conditions. Following distance must be adjusted or the system switched off when required by the prevailing conditions.

Detecting the vehicle ahead

If the system detects a vehicle in the driving path, the adaptive cruise control symbol displayed in the Driver Information Centre changes from  to .

Deactivation of the functionality

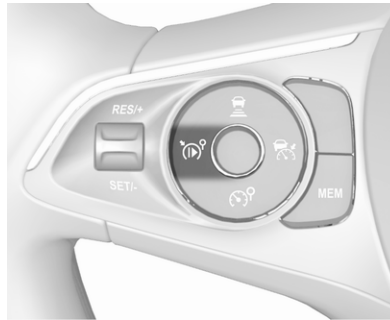

Press , the adaptive cruise control is in pause mode and a message is displayed. The vehicle is driven without adaptive cruise control.

The adaptive cruise control is deactivated, but not disabled. The last stored set speed remains in memory for later usage.

The adaptive cruise control is deactivated automatically in the following cases:

- The brake pedal is depressed.
- The vehicle accelerates above 112 mph (manual and automatic transmission) or slows down below 25 mph (manual transmission).
- The electric parking brake is applied.
- The traction control system or electronic stability control is deactivated or operating.
- The selector lever of automatic transmissions is neither in **D** nor in **M**.
- A fault is detected in the electronic stability control, the radar system or the camera system.
- Immediately after the clutch pedal has been depressed or a few seconds after the clutch pedal has been depressed (depending on the manual transmission).

Switching off the system

Press , the adaptive cruise control mode is disabled and the adaptive cruise control indication extinguishes in the Driver Information Centre.

Pressing  to activate the speed limiter deactivates adaptive cruise control.

Switching off the ignition deletes the stored set speed.

Driver's attention

- Use the adaptive cruise control carefully on bends or mountain roads, as it can lose the vehicle ahead and needs time to detect it again.
- Do not use the system on slippery roads as it can create rapid changes in tyre traction (wheel spinning), so that you could lose control of the vehicle.
- Do not use the adaptive cruise control during rain, snow or heavy dirt, as the radar sensor can be covered by a water film, dust, ice or snow. This reduces or suppresses completely the

visibility. In case of sensor blockage, clean the sensor cover.

- Do not use the system when the spare wheel is in use.

System limits

Warning

The system's automatic brake force does not permit hard braking and the braking level may not be sufficient to avoid a collision.

- After a sudden lane change, the system needs a certain time to detect the next preceding vehicle. So if a new vehicle is detected, the system may accelerate instead of braking.
- The adaptive cruise control only considers traffic driving in the same direction.
- The adaptive cruise control does not consider pedestrians and animals for braking and driving off.

- The adaptive cruise control considers stopped vehicles only at low speed.
- Do not use the adaptive cruise control when towing a trailer.
- Do not use the adaptive cruise control on roads with an incline of more than 10%.

As the radar's field of detection is quite narrow, it is possible that the system may not detect:

- vehicles of reduced width, e.g. motorcycles, scooters
- vehicles not running in the middle of the lane
- vehicles entering a corner
- vehicles suddenly pulling out

Bends

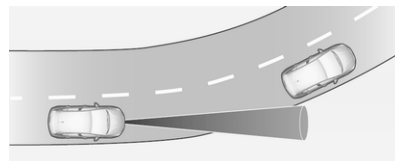

The adaptive cruise control calculates a predicted path based on the centrifugal force. This predicted path considers the current bend characteristic, but cannot consider a future bend change. The system may lose the current vehicle ahead or consider a vehicle which is not in the actual lane. This can happen when entering or exiting a bend or if the bend gets stronger or weaker. If it no longer detects any vehicle ahead, then  will extinguish.

If the centrifugal force is too high in a bend, the system slows down the vehicle slightly. This braking level is not designed to avoid spinning-off the bend. The driver is responsible for reducing the selected speed before entering a bend and in general to adapt the speed to the road type and to existing speed limits.

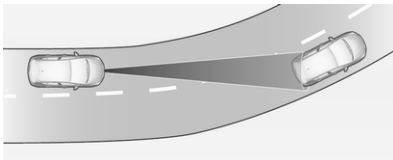

Motorways

On motorways, adapt the set speed to the situation and the weather. Always consider that adaptive cruise control has a limited visibility range, a limited braking level and a certain reaction time to verify if a vehicle is on the driving path or not. Adaptive cruise control may not be able to brake the vehicle in time to avoid a collision with a much slower vehicle or after a lane change. This is particularly true while driving fast or if the visibility is reduced due to weather conditions.

While entering or exiting a motorway, adaptive cruise control may lose the vehicle ahead and accelerate up to the set speed. For this reason, decrease the set speed before the exit or before the entry.

Vehicle path changes

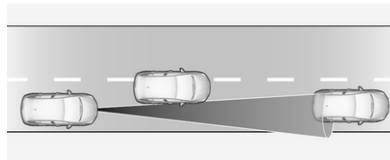

If another vehicle enters your driving path, adaptive cruise control will first consider the vehicle when it is completely in your path. Be ready to take action and depress the brake pedal if you need to brake more quickly.

Hill considerations

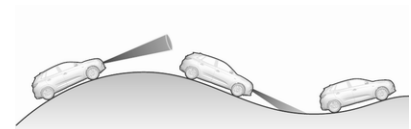

Warning

Do not use the adaptive cruise control on steep hill roads.

System performance on hills depends on vehicle speed, vehicle load, traffic conditions and the road gradient. It may not detect a vehicle in your path while driving on hills. On steep hills, you may have to use the accelerator pedal to maintain your vehicle speed.

When going downhill you may have to brake to maintain or reduce your speed.

Note that applying the brake deactivates the system.

Radars unit



The radar unit is located in the middle of the front bumper.

⚠ Warning

The radar unit was aligned carefully during manufacture. Therefore, in the event of a front-end impact, do not use the system.

The front bumper may appear to be intact, however the sensor behind may be affected and react incorrectly. After an accident, consult a workshop to verify and adjust the radar unit position.

⚠ Warning

The usage of a license plate support on the front bumper may affect the proper radar unit functionality.

When using a license plate support, follow the markings and indications on the front bumper.

Fault

In the event of an adaptive cruise control fault, a warning light is illuminated in the Driver Information Centre and a warning message is displayed in the Driver Information Centre accompanied by an audible signal.

The speed limit recognition may not operate correctly if traffic signs do not comply with the Vienna Convention on Road Signs and Signals.

Have the system checked by a dealer or a qualified workshop.

As a safety measure, do not use the system if the brake lights are faulty. Do not use the system if the front bumper is damaged.

Forward collision alert

The forward collision alert may help to avoid or reduce the harm caused by front-end crashes.

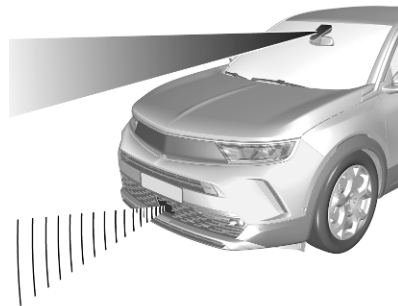

The forward collision alert uses the front camera in the windscreen and depending on the vehicle configuration a radar unit located behind the front bumper to detect a vehicle directly ahead, in the path.

If a vehicle directly ahead is approached too quickly, a warning chime sounds and a message is displayed in the Driver Information Centre.

Warning

Forward collision alert is just a warning system and does not apply the brakes. When approaching a vehicle ahead too rapidly, it may not provide you enough time to avoid a collision.

The driver accepts full responsibility for the appropriate following distance based on traffic, weather and visibility conditions.

The complete attention of the driver is always required while driving. The driver must always be ready to take action and apply the brakes.

Activation

The forward collision alert operates from 3 mph to vehicle's maximum speed.

Alerting the driver

The driver is warned by following alerts:

- A warning message is displayed in the Driver Information Center, when the distance to the vehicle ahead gets too small.
- A warning message is displayed in the Driver Information Center and a warning chime sounds, when a collision is imminent and immediate driver's action is required.
- In some cases, the system performs a short braking, when a collision is imminent and immediate driver's action is required.

Selecting the alert sensitivity

Three alert sensitivities can be selected in the settings of the active emergency braking within the vehicle personalisation ⇨ 81.

The chosen setting will be memorised when the ignition has been switched off. The alert timing will vary based on selected alert setting.

Deactivation

The system can only be deactivated by deactivating the active emergency braking in the vehicle personalisation ⇨ 81. When ignition is switched on next time, system is activated.

System limitations

Forward collision alert is designed to warn on vehicles, pedestrians and cyclists, but may react also to other objects.

In the following cases, forward collision alert may not detect a vehicle ahead or sensor performance is limited:

- driving on winding or hilly roads
- driving during nighttime
- weather limits visibility, such as fog, rain, or snow
- the sensor in the windscreen or the radar unit behind the front bumper are blocked by snow, ice, slush, mud, dirt etc.
- the windscreen is damaged or affected by foreign objects, e.g. stickers
- the bumper is damaged or affected by foreign objects, e.g. license plate support

Active emergency braking

Active emergency braking can help to reduce the damage and injury from crashes with vehicles and pedestrians directly ahead, when the driver does not actively take action either by manual braking or by steering. For vehicles equipped with

camera and radar, active emergency braking also detects cyclists. Before the active emergency braking applies, the driver is warned by the forward collision alert.

Forward collision alert ⇨ 198.

Front pedestrian protection ⇨ 204.

Active emergency braking can be deactivated in the vehicle personalisation ⇨ 81. Depending on version, this is only possible at a standstill. If deactivated,  illuminates in the Driver Information Centre. When ignition is switched on next time, system is automatically activated.

The feature uses various inputs (e.g. camera sensor, radar sensor) to calculate the probability of a frontal collision.

Warning

This system is not intended to replace the driver's responsibility for driving the vehicle and looking ahead. It warns the driver if the vehicle is at risk of a collision with

the preceding vehicle, a pedestrian or a cyclist. Just before the imminent collision, it reduces the vehicle's speed to avoid a collision or to limit its severity.

The system may not react to animals. After a sudden lane change, the system needs a certain time to detect the next preceding vehicle.

The driver must always be ready to take action and apply the brakes and steer to avoid collisions.

Functionality

Depending on the vehicle configuration and the detected objects, there are several operational speed ranges.

Active emergency braking operates up to 50 mph when a pedestrian has been detected.

On vehicles equipped with radar sensor and front camera, the active emergency braking operates up to 50 mph when a stationary vehicle or a cyclist has been detected.

On vehicles equipped only with front camera, the active emergency braking operates from 3 mph to 50 mph or 87 mph when a moving vehicle has been detected.

On vehicles equipped with radar sensor and front camera, the active emergency braking operates from 3 mph to 87 mph when a moving vehicle has been detected.

The system includes:

- brake preparation system
- emergency automatic braking
- smart brake assist
- forward collision alert
- front pedestrian protection



Brake preparation system

When approaching a vehicle ahead or a pedestrian so quickly that a collision is likely, the brake preparation system slightly pressurises the brakes. This reduces the response time, when braking is requested.

The pressurisation of the brakes may produce a noise in the brake system.

Emergency automatic braking

After activation of brake preparation system and just before the imminent collision, this function automatically applies braking to reduce the impact speed of the collision or prohibit a crash.

If active emergency braking is applied,  flashes in the Driver Information Centre. If active emergency braking is finished,  flashes for a few seconds. During this time, active emergency braking cannot be applied if there is a risk of a further collision.

Forward collision alert ⇨ 198.

Front pedestrian protection ⇨ 204.

Depending on version, below a speed of 19 mph or 31 mph, emergency automatic braking may slow down the vehicle to a complete stop. If the speed exceeds this limit, emergency automatic braking reduces the speed. However, the driver must apply the brake to come to a complete stop.

- Automatic transmission: If the vehicle comes to a complete stop, automatic braking is

maintained for a certain time. Keep the brake pedal depressed to prevent the vehicle from starting off again.

- Manual transmission: If the vehicle comes to a complete stop, the engine may stall. Keep the brake pedal depressed to prevent the vehicle from rolling away.

Cruise control and adaptive cruise control will be deactivated when an emergency automatic braking occurs.

In some cases, the active emergency braking system may provide an automatic braking in situations that seem to be unnecessary. Firmly apply the accelerator pedal or firmly turn the steering wheel to override the automatic braking if the situation and the surroundings permit.

Warning

Do not rely on the system to brake the vehicle. Emergency automatic braking is only applied just before the collision and it will not brake

outside of its operating speed range. It only responds to detected vehicles and pedestrians. For vehicles equipped with camera and radar, it also responds to detected cyclists.

Antilock brake system ⇨ 182.

Smart brake assist

If the driver brakes, but not sufficiently to avoid a collision, this system will supplement the braking. This assistance will only be provided if the driver presses the brake pedal.

Smart brake assist will automatically disengage when the brake pedal is released.

Forward collision alert ⇨ 198.

Front pedestrian protection ⇨ 204.

Operation conditions

Active emergency braking only works when

- the seat belts of the front seats and depending on version of the rear seats are fastened
- the brake system is operational
- Electronic Stability Control and Traction Control system are activated

Active emergency braking is automatically deactivated in the following cases:

- A spare wheel with smaller diameter is detected.
- A fault with the brake pedal switch or with the left or right brake light is detected.
- A fault in the active emergency braking system, in the electronic or in the brake system is detected.
- A severe crash, e.g., with airbag deployment was detected.

System limitations

The system performance may be degraded or not available in the following cases:

- sensor covered with snow, ice, slush, mud or dirt
- windscreen damaged or smeared, with blurred view or covered with foreign items, e.g. stickers,
- damaged or deformed front bumper or front bumper covered with foreign items, e.g. stickers
- radar unit is out of its regular position resulting from an impact of the front bumper
- front camera out of its regular position
- automatic braking not available, e.g. brake discs cooling going on
- brake pedal continuously used for a long time, e.g. on a long downhill road
- winding or hilly roads
- during initialisation of the system, e.g. after the vehicle battery has been disconnected

- sun or lights shining into the front camera lens
- adverse environmental conditions, e.g. rain, fog, or snow
- vehicle ahead creating road spray

After an impact or when damages are visible have the vehicle checked by a workshop.

The system performance may be affected by:

- electronic stability control and traction control system in operation
- vehicle battery out of normal operation voltage
- wet road reflecting lights
- close vehicles ahead
- tractors, muddy vehicles or vehicles with a trailer
- banked roads
- poor lighting conditions
- sudden lighting changes
- vehicle modifications, e.g. tyres
- vehicle overloaded

If a sensor is covered, a message is displayed indicating that the sensors have to be cleaned.

If the system is temporarily affected and no driver action is required, no message is displayed.

Complete attention is always required while driving, and be ready to take action to avoid crashes.

We recommend to deactivate the system in the vehicle personalisation in the following cases:

- when towing a trailer or caravan
- when carrying long objects on roof bars or a roof rack
- when the vehicle is being towed
- when performing any maintenance with ignition on
- when the vehicle is fitted with snow chains
- when a spare wheel is fitted that is smaller than the other wheels
- before using an automatic car wash
- before placing the vehicle on a rolling road in a workshop

- if the windscreen has been damaged close to the camera
- if the front bumper has been damaged or deformed
- if the radar unit is out of its regular position resulting from an impact of the front bumper
- if the brake lights are not working

Fault

If the system has a fault,  illuminates in the Driver Information Centre, a message is displayed and an audible signal is given. Consult a workshop.

If the system does not work properly or is not available, e.g. during the initialisation,  illuminates in the Driver Information Centre.

If  and  illuminate in the Driver Information Centre after the engine has been switched off and then restarted, consult a workshop.

Vehicle messages ⇨ 80.

Automatic post collision braking

If an accident is detected, the vehicle requests automatic post collision braking. The goal of this function is to reduce the risk of further collisions if the driver does not react. The automatic post collision braking is not operational if the capability of the vehicle to trigger and execute the automatic post collision braking is unavailable, as it can occur in destructive accidents or in other specific accident scenarios.



It is possible to override the automatic braking by pressing the accelerator pedal or the brake pedal.

System limitations

The system operates if the following conditions are fulfilled:

- airbags or seat belt pretensioners have been deployed by the collision
- braking system and electric functions remain continuously operational during and after collision
- driver has not depressed brake pedal or accelerator pedal

Fault

If automatic post collision braking is not available, the control indicator  or  illuminates continuously, a corresponding message appears in the Driver Information Centre and a warning chime sounds.

Have the cause of the fault remedied by a workshop.

Front pedestrian protection

Front pedestrian protection may help to avoid or reduce the harm caused by front-end crashes with pedestrians when driving forward.

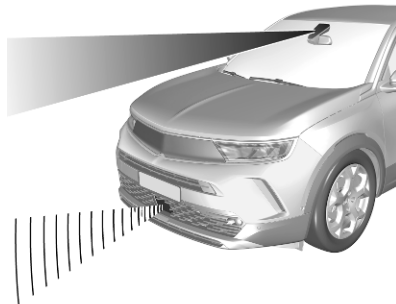

The system uses the front camera in the windscreen and depending on the vehicle configuration a radar unit in the front bumper to detect a pedestrian directly ahead in the path.

⚠ Warning

The usage of a license plate support on the front bumper may affect the proper radar unit functionality.

When using a license plate support, follow the markings and indications on the front bumper.

Front pedestrian protection can detect and alert to pedestrians in a forward gear at speeds between 3 mph and 50 mph. Additionally, it can automatically brake the vehicle.

During nighttime driving, system performance is limited.

⚠ Danger

Front pedestrian braking does not provide an alert or automatically brake the vehicle, unless it detects a pedestrian.

The system may not detect pedestrians, including children, when the pedestrian is not directly

ahead, not fully visible, not standing upright, or when part of a group.

The system can only be deactivated by deactivating the active emergency braking in the vehicle personalisation ⇨ 81. When ignition is switched on next time, system is activated.

Front pedestrian alert

When approaching a detected pedestrian too quickly, a warning message is displayed in the Driver Information Centre. A warning chime is provided.

Cruise control or adaptive cruise control may be disengaged when the front pedestrian alert occurs.

System limitations

In the following cases, front pedestrian protection may not detect a pedestrian ahead or sensor performance is limited:

- driving on winding or hilly roads
- driving in the dark

- weather limits visibility, such as fog, rain, or snow
- the sensor in the windscreen or the radar unit behind the front bumper is blocked by snow, ice, slush, mud, dirt or by foreign objects, e.g. stickers
- the windscreen is damaged
- the bumper is damaged

Parking assist**General information**

The rear system is deactivated when a plug is connected to the power outlet of the trailer hitch.

⚠ Warning

The driver bears full responsibility for the parking manoeuvre.

Always check the surrounding area when driving backwards or forwards while using parking assist system.

Rear parking assist

The system warns the driver with audible signals and a display indication against potentially hazardous obstacles behind the vehicle while the reverse gear is engaged.

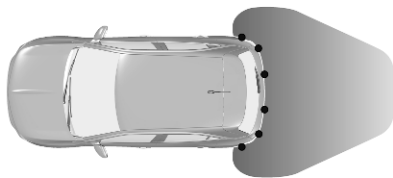

The system operates with ultrasonic parking sensors in the rear bumper.

Activation

After engaging the reverse gear, an audible signal is given from the rear speakers and a display indication will be shown. If no audible signal is

given, the display indication is not shown or a warning message appears, the system has a failure.



Depending on version the system is ready to operate when the LED in the parking assist button $P \triangle$ OFF is not illuminated. The state of the system is memorised when the ignition is switched off.

Deactivation

The system is switched off when reverse gear is disengaged.



Press $P \triangle$ OFF to deactivate the system manually. The LED in the button illuminates when the system is deactivated. If the system has been deactivated manually, it is not reactivated automatically the next time the ignition is switched on.

Indication

As soon as an obstacle gets closer to the vehicle, an audible signal is given and the symbol $P \triangle$ may flash. The interval between the sounds becomes shorter as the vehicle gets closer to that obstacle. When the distance is less than approx. 30 cm, the sound is continuous.

If the vehicle stops for more than three seconds, if the automatic transmission is in **P** position, or if no further obstacles are detected, no audible signals are given.

Notice

An audible signal is not given if the sound has been muted or if the display of the rear view camera indicated on the Info Display has been switched off.

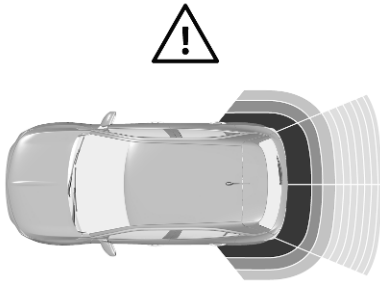

Additionally, the distance to rear obstacles is displayed by changing distance lines in the Info Display ↗ 78. When the obstacle is very close, ⚠ for danger is displayed.

Muting the sound / closing the display indication

If the audible signal is muted or the display of the rear view camera is closed and an obstacle gets closer, only the $P \Delta$ flashes.

When engaging the forward gear and driving more than 6 mph the sound and the display are automatically resumed.

Front-rear parking assist

The front-rear parking assist measures the distance between the vehicle and obstacles in front and behind the vehicle. It informs and warns the driver by giving audible signals and a display indication.

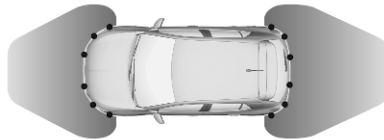

The system operates with ultrasonic parking sensors in the rear and front bumper.

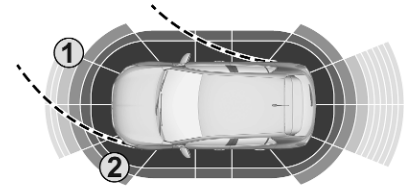

If the obstacle (1) is within the driving path and might lead to a collision, an audible signal is given.

The interval between the sounds becomes shorter as the vehicle gets closer to the obstacle in the driving path. When the distance is less than approx. 30 cm, the sound is continuous.

Obstacles (2) that are close to the vehicle, but not within the calculated driving path are indicated in the Info Display, but no audible signal is given.

The distance to rear, front and lateral obstacles is displayed by changing distance lines in the Info Display ↪ 78.

If the vehicle stops for more than three seconds in a forward gear, if the automatic transmission is in **P** position, the vehicle speed exceeds 6 mph or if no further obstacles are detected, no audible signals are given and no visual feedback is displayed in the Info Display.

Side protection

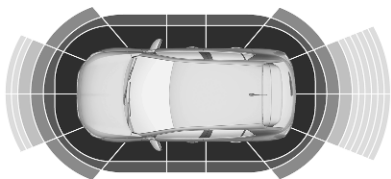

This function warns the driver by display indication in the case of obstacles alongside the vehicle. If the

obstacle is alongside the vehicle and within the driving path and might lead to a collision, an audible signal is given. Obstacles alongside the vehicle are only considered if they have been previously recognised by the parking sensors and memorised by the system.

⚠ Warning

Only fixed obstacles are indicated correctly.

Moving obstacles detected at the beginning of a manoeuvre may be indicated mistakenly.

Moving obstacles that appear alongside the vehicle and were not previously recognised by the parking sensors will not be indicated.

Objects memorised during the manoeuvre will only be considered during the current ignition cycle.

Activation

When a forward gear has been engaged, the front parking assist is triggered, as soon as an obstacle is detected in the front and the speed of the vehicle is below 6 mph.

When the reverse gear has been engaged, the front parking assist is triggered additionally to the rear parking assist.

After engaging the reverse gear, an audible signal is given from the rear speakers and a display indication will be shown. If no audible signal is given, the display indication is not shown or a warning message appears, the system has a failure.



Depending on version the system is ready to operate when the LED in the parking assist button P_{OFF} is not illuminated. The state of the system is memorised when the ignition is switched off.

Deactivation

The system is switched off when reverse gear is disengaged.



Press P_{OFF} or apply the electric parking brake to deactivate the system manually. When the system is deactivated manually, the LED in the button illuminates. If the system has

been deactivated manually, it is not reactivated automatically the next time the ignition is switched on.

Indication

As soon as an obstacle gets closer to the vehicle, an audible signal is given and the symbol P_{Δ} may flash. The interval between the sounds becomes shorter as the vehicle gets closer to that obstacle. When the distance is less than approx. 30 cm, the sound is continuous.

Audible signals are given via front or rear loudspeakers depending on which detected obstacle is nearest to the vehicle.

If the vehicle stops for more than three seconds, if the automatic transmission is in **P** position, or if no further obstacles are detected, no audible signals are given.

Notice

An audible signal is not given if the sound has been muted or if the display of the rear view camera indicated on the Info Display has been switched off.

Additionally, the distance to obstacles is displayed by changing distance lines in the Info Display ↷ 78. When the obstacle is very close, Δ for danger is displayed.

Muting the sound / closing the display indication

If the audible signal is muted or the display of the rear view camera is closed and an obstacle gets closer, only the P_{Δ} flashes.

When engaging the forward gear and driving more than 6 mph the sound and the display are automatically resumed.

System limitations

In the event of a fault or if the system does not work temporarily, e.g. because of high external noise level or other interference factors,  illuminates in the Driver Information Centre. A message is displayed in the Driver Information Centre and a warning chime sounds.

In the case of a permanent fault, seek the assistance of a workshop.

⚠ Warning

Under certain circumstances, various reflective surfaces on objects or clothing as well as external noise sources may cause the system to fail to detect obstacles.

Special attention must be paid to low obstacles which can damage the lower part of the bumper.

Caution

In the case of a severe failure of the vehicle with the need to stop the vehicle, the system is deactivated.

In the case of a gearbox failure, the parking assist system is not active, when reverse gear is engaged.

In the case of a loudspeaker failure, the audible signals may not be given.

Performance of the system can be reduced when sensors are covered, e.g. by ice or snow.

If a sensor is covered, a message is displayed indicating that the sensors have to be cleaned.

Performance of the parking assist system may be limited or the functionality may not be available at all if  illuminates or if the image shown on the Info Display is frozen or if the screen is black.

Performance of the parking assist system can be reduced due to heavy loading.

Special conditions apply if there are taller vehicles in the vicinity (e.g. off-road vehicles, mini vans, vans). Object identification and correct distance indication in the upper part of these vehicles cannot be guaranteed.

Objects with a very small reflection cross-section, e.g. objects of narrow size or soft materials, may not be detected by the system.

Parking assist systems do not detect objects outside the detection range, e.g. below the bumper or underneath the vehicle.

During a reverse parking manoeuvre, the system does not consider a mounted coupling ball bar. The driver has to consider this additional length.

Notice

It is possible that the sensor detects a non-existing object caused by echo disturbance from external acoustic noise or mechanical misalignments (sporadic false warnings may occur).

Make sure that the front number plate is properly mounted (not bent and no gaps to the bumper on the left or right side) and the sensors are firmly in place. The performance of the parking assist may be reduced if the license plate is bent or a license plate support is used.

Low curbs and surface irregularities, e.g. on construction zones, are not detected by the system. The driver accepts responsibility.

Advanced parking assist

⚠ Warning

The driver bears full responsibility for accepting the parking slot suggested by the system and the parking manoeuvre.

Always check the surrounding area in all directions when using the advanced parking assist.

The advanced parking assist measures a suitable parking slot while passing, calculates the trajectory and automatically steers the vehicle while parking.

Advanced parking assist provides assistance for the following manoeuvres:

- entry into a parallel parking slot
- entry into a perpendicular parking slot
- exit from a parallel parking slot

The driver must control acceleration, braking and gear shifting, while steering is done automatically. The driver can take control at any time by gripping the steering wheel.

It may be necessary to move forwards and backwards more than once.

Instructions are given in the Info Display ↗ 78.

Advanced parking assist can only be activated when driving forwards.

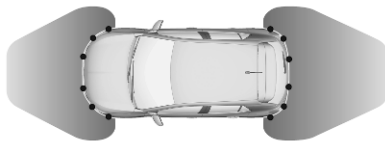

Advanced parking assist is always combined with front-rear parking assist.

The system has six ultrasonic parking sensors each in both the rear and front bumper.

Entry into a parallel parking slot

Activation

Slow down the vehicle speed below 19 mph.



Press  or activate the system via the Info Display.

Info Display ↗ 78.

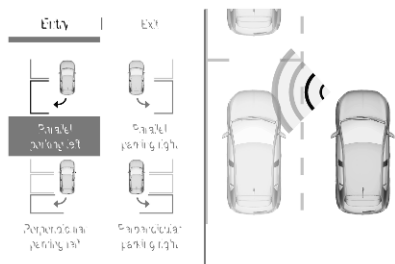

Select the parallel parking slot menu. **P** is illuminated in the Driver Information Centre to confirm the activation of the system.

The allowed parallel distance between the vehicle and a row of parked cars is between 0.5 m and 1.5 m.

The system will not identify slots that are clearly smaller than the vehicle.

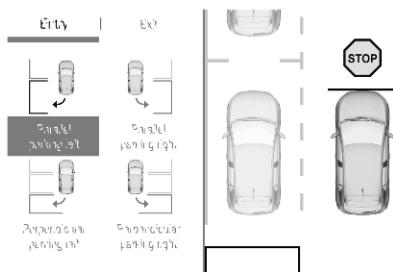

When a free slot is detected, a visual feedback on the Info Display and a first acoustic signal are given.

Drive slowly forwards. When the second acoustic signal is given, stop the vehicle, select reverse gear, release the steering wheel and start moving slowly. A visual feedback is given on the Info Display.

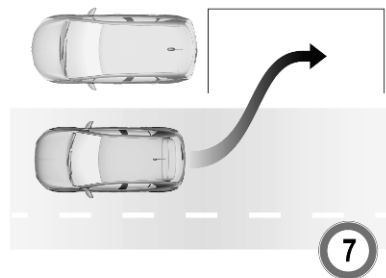

Move forwards and backwards while observing the warnings of the parking assist until the end of manoeuvre is indicated.

Entry into a perpendicular parking slot

Activation

Slow down the vehicle speed below 19 mph.



Press **P** or activate the system via the Info Display.
Info Display \rightarrow 78.

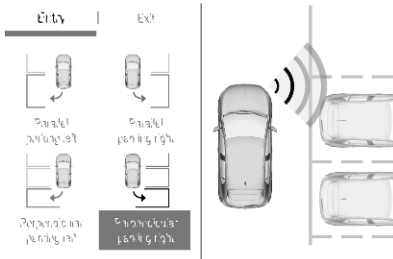

Select the perpendicular parking slot menu. **P** is illuminated in the Driver Information Centre to confirm the activation of the system.

The allowed parallel distance between the vehicle and a row of parked cars is between 0.5 m and 1.5 m.

When several successive slots are found, the vehicle will be directed towards the last one.

The system will not identify slots that are clearly smaller than the vehicle.

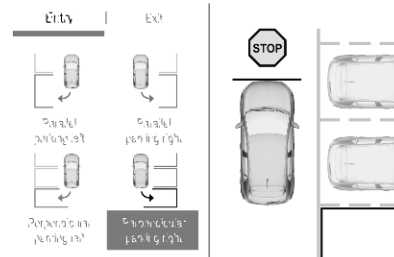

When a free slot is detected, a visual feedback on the Info Display and an acoustic signal are given. Stop the

vehicle, select reverse gear, release the steering wheel and start moving without exceeding 4 mph.

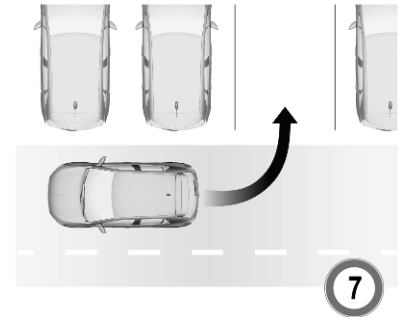

Move forwards and backwards as instructed by observing the warnings of the parking assist and paying attention to the acoustic signals until the end of manoeuvre is indicated.

During the parking manoeuvre, the system is automatically deactivated once the rear of the vehicle is within 50 cm of an obstacle.

Exiting a parallel parking slot

Activation



Press **P** or activate the system via the Info Display.
Info Display \rightarrow 78.

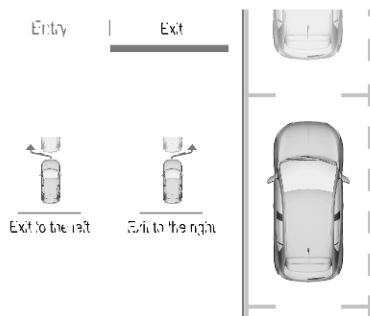

Select the exit side in the menu. **P** is illuminated in the Driver Information Centre to confirm the activation of the system.

Engage reverse or forward gear, release the steering wheel and start moving without exceeding 3 mph.

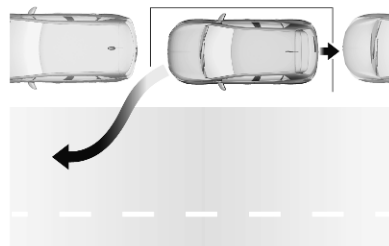

Move forwards and backwards while observing the warnings of the parking assist until the end of manoeuvre is indicated.

The manoeuvre is complete when the vehicle's front wheels are out of the parking slot.

After deactivation ensure to take control over the vehicle.

Display indication

The instructions on the display show:

- general hints and warning messages
- the demand to stop the vehicle, when a parking slot is detected

- the direction of driving during the parking manoeuvre
- the demand to shift into reverse or first gear
- the demand to stop or to drive slowly
- the successful completion of the parking manoeuvre indicated by a pop-up symbol and a chime
- the cancelling of a parking manoeuvre

Deactivation

Do not use the advanced parking assist when a temporary spare wheel is mounted. The rear view camera may not work properly.

The current park assist manoeuvre is cancelled via the button to return to the previous screen in the Info Display. To deactivate the system completely, press  in the centre console.

The system is deactivated automatically:

- if the ignition is switched off
- if stalling the engine

- if no manoeuvre is started within 5 minutes of selection of the type of manoeuvre
- after a prolonged stop of the vehicle during a manoeuvre
- activating the turn light on the opposite side to that of the manoeuvre
- if the electronic stability control is triggered
- if the speed of the vehicle exceeds the stated limit
- when the driver interrupts movement of the steering wheel
- after ten manoeuvres to enter or exit a parallel parking slot or after seven manoeuvres to enter a perpendicular parking slot
- by opening the driver's door
- if one of the front wheels encounters an obstacle
- parking manoeuvre successfully ended

Deactivation by the driver or by the system during manoeuvring will be indicated on the display. Additionally, a chime sounds.

The system is deactivated when a plug is connected to the power outlet of the trailer hitch.

Contact your dealer to switch off the system for a prolonged period.

Fault

In the event of a fault, a message is displayed in the Colour Info Display, accompanied by an acoustic signal.

In the event of a fault in the power steering,  illuminates and a message is displayed in the Driver Information Centre.

Notice

Advanced parking assist system may not respond to changes in the available parking space after initiating a parking manoeuvre. The system may recognize an entry, a gateway, a courtyard or even a crossing as a parking slot. Take care regarding the availability of the suggested parking slot.

Side blind spot alert

Side blind spot alert assist helps to avoid crashes due to unintentional lane departures when an object is detected within a specified blind spot zone.

The system displays a visual alert in each exterior mirror, when detecting objects that may not be visible in the interior and exterior mirrors.

Side blind spot alert uses some of the advanced parking assist sensors which are located in the front and rear bumper on both sides of the vehicle.

Warning

Side blind spot alert is only a lane changing aid and does not replace driver vision.

Side blind spot alert does not detect:

- Vehicles outside the side blind zones which may be rapidly approaching.
- Pedestrians or animals.

- Non-moving objects, e.g. stationary vehicles, street lights, road signs, etc.

Failure to use proper care when changing lanes may result in damage to the vehicle, injury, or death. Always check the outside and rearview mirrors, glance over your shoulder, and use the turn signal before changing lanes.

Activation

The system can be activated via the vehicle settings menu in the Info Display.

Info Display ⇨ 78.

Functionality

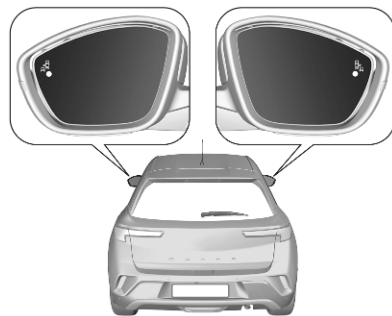

When the system detects a vehicle in the side blind zone while driving forwards, an LED will illuminate in the relevant exterior mirror. If the turn lights of the relevant side are activated, the LED will flash.

The LED comes on immediately when your vehicle is being passed.

The LED comes on after a delay when your vehicle is passing another vehicle slowly.

Operation conditions

The following conditions must be fulfilled for proper operation:

- all vehicles are moving in the same direction and in adjacent lanes
- the speed of your vehicle is between 7 or 20 and 87 mph
- passing a vehicle with a speed difference of less than 6 mph
- another vehicle is passing with a speed difference of less than 15 mph
- the traffic flow is normal
- driving on a straight or slightly curved road
- no plug is connected to the power outlet of the trailer hitch
- the sensors are not covered by mud, ice or snow
- the warning zones in the door mirrors or the detection zones on front and rear bumper are not covered with adhesive labels or other objects

No alert will be given in the following situations:

- in the presence of non-moving objects, e.g. parked vehicles, barriers, street lamps, road signs
- in very dense traffic, when moving vehicles might be confused with a stationary object
- with vehicles moving in the opposite direction
- driving on a winding road or a sharp corner
- when passing or being passed by a very long vehicle, e.g. lorry, coach, which is at the same time detected at the rear in the blind spot angle and present in the driver's forward field of vision
- when passing too quickly

Deactivation

The system can be activated via the vehicle settings menu in the Info Display.

Info Display ⇨ 78.

The state of the system is memorised when switching off the ignition.

The system is deactivated when a plug is connected to the power outlet of the trailer hitch.

Due to adverse weather conditions, such as heavy rain, false detections may occur.

Fault

In the event of a fault,  appears in the Driver Information Centre, accompanied by a display message. Seek the assistance of a workshop.

Rear view camera

The rear view camera assists the driver when reversing. It allows views of the vehicle's surroundings to be displayed as a nearly 180° picture in the Info Display, like a bird's eye view.

Warning

The rear view camera does not replace driver vision. Note that objects that are outside the camera's field of view and the

parking assist sensors, e.g. below the bumper or underneath the vehicle, are not displayed.

Do not reverse or park the vehicle using only the rear view camera.

Always check the surrounding of the vehicle before and during driving.

The system may use:

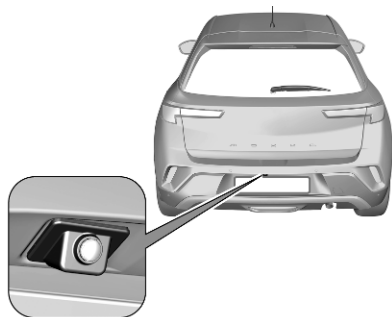

- rear view camera, installed above the rear number plate
- ultrasonic parking sensors in the rear bumper

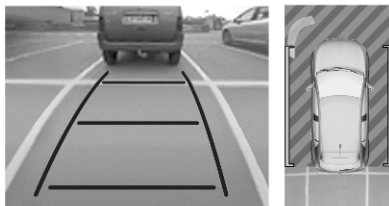

The screen in the Info display is divided into two parts. On the right there is a view from above the vehicle, and on the left there is the view from the rear displayed. If the vehicle is equipped with ultrasonic parking sensors, they complete the information on the view from above the vehicle.

The area displayed by the rear view camera is limited. The distance of the image that appears on the display differs from the actual distance.

Activation

Rear view camera is activated when reverse gear is engaged.

Functionality

Different views can be selected in the left part of the display. Change the type of view at any time during a manoeuvre by pressing the touch field in the left lower zone of the display and selecting a view from the view selection menu:

- Standard view
- Auto mode
- Zoom view
- 180° view

The display is immediately updated with the type of view selected.

Auto mode is activated by default. In this mode, the system selects the best view, standard or zoom, to display according to the information from the parking sensors.

The state of the system is not kept in memory when the ignition is switched off.

Standard view



The area behind the vehicle is displayed in the screen. The vertical lines represent the width of the vehicle with mirrors unfolded. The direction of the lines changes with the position of the steering wheel.

The first horizontal line represents a distance of about 30 cm beyond the edge of vehicle's rear bumper. The upper horizontal lines represent distances of about 1 m and 2 m.

This view is available in auto mode or in the view selection menu.

Trajectory lane of the vehicle is shown in accordance with the steering angle.

Auto mode

This mode is activated by default. If the vehicle is equipped with ultrasonic parking sensors, the automatic view changes from rear view to a view from above, as an obstacle is approached during a manoeuvre.

If the vehicle is not equipped with ultrasonic parking sensors, the view needs to be changed manually in the Info Display.

Zoom view



The rear view camera records the vehicle's surroundings during the manoeuvre in order to reconstruct a view from above the vehicle in its near surroundings. Thus, the vehicle can be manoeuvred around obstacles nearby. This view is available with auto mode or in the view selection menu.

180° view

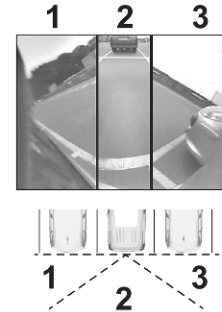

The 180° view facilitates reversing out of a parking bay, making it possible to see the approach of vehicles, pedestrians and cyclists. This view is not recommended for carrying out a complete manoeuvre.

It is made up of three areas: left 1, centre 2 and right 3. This view is available from the view selection menu only.

Deactivation

The rear view camera is deactivated when:

- a plug is connected to the power outlet of the trailer hitch
- a certain forward speed is exceeded or if reverse gear is not engaged for 7 seconds
- by pressing the icon  in the left upper corner of the touch screen

System limitations

Caution

For optimal operation of the system, it is important to keep the lense of the camera, which is located in the bumper between the number plate lights, always clean. Rinse the lenses with water and wipe with a soft cloth.

Do not clean the lenses with a steam-jet or high-pressure jet cleaner.

The rear view camera may not operate properly when:

- surrounding is dark
- sun or beam of headlights is shining directly into camera lenses
- weather limits visibility, such as fog, rain, or snow
- camera lenses blocked by snow, ice, slush, mud, dirt. Clean the lense, rinse with water, and wipe with a soft cloth
- vehicle had a rear end accident
- extreme temperature changes

Traffic sign assistant

Warning

The actual traffic sign always takes priority over the traffic sign displayed in the Driver Information Centre.

Depending on version, are two different systems available.

Speed limit system 1

Using the camera at the top of the windscreen and the vehicle's integrated navigation system, this system provides speed limits and end of speed limits in the Driver Information Centre.

The system can be activated or deactivated in the vehicle personalisation  81.

If the system is activated but does not detect a speed limit sign, the following sign is displayed:

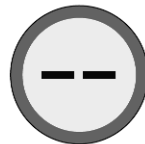

If the vehicle exceeds the speed limit by at least 3 mph, the speed limit displayed flashes about ten seconds.

Speed limiter  190.

Cruise control  188.

Adaptive cruise control ⇨ 192.

Updating navigation map data

To maintain the performance of the system, the navigation map should be updated in periodical intervals. A navigation map update is available twice per year.

Further information is available in the Infotainment system section.

Speed limit system 2

This system displays permanently speed limit information in the Driver Information Centre.

Providing the speed limit information involves the following systems:

- camera at the top of the windscreen
- vehicle's integrated navigation system
- telematics service

If travelling on a road with no speed restrictions, e.g., on German motorways, the following sign is displayed:

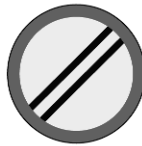

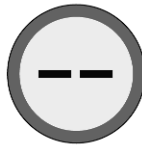

If no speed limit information can be provided, the following sign is displayed:



If a new speed limit is provided, a confirmation chime is given. The confirmation chime can be activated / deactivated in the vehicle personalisation ⇨ 81.

If the vehicle exceeds the speed limit, the speed limit displayed after some time in the Driver Information Centre flashes and an audible signal is given after some time. Time of occurrence varies. Both flashing and audible signal are terminated after a few seconds. Due to legal requirements,

the audible signal can only be deactivated in the vehicle personalisation until the next time the ignition is switched on. If the audible signal is deactivated,  illuminates for a few seconds.

In case of a failure,  illuminates permanently. Consult a workshop.

Speed limiter ⇨ 190.

Cruise control ⇨ 188.

Adaptive cruise control ⇨ 192.

Operation conditions

To provide country-specific speed limit information, the vehicle needs to identify the country it is currently in. If a corresponding country list is available in the Info Display, the respective country has to be selected manually. Otherwise, the country is automatically selected.

To get valid speed limit information, the vehicle's current position is sent via the telematics unit and is immediately deleted after processing. Tracking of the vehicle position is not possible at any time.

This is not impacted by the privacy settings of Vauxhall Connect.

Notice

It is possible to report a permanent speed limit misinformation on our website.

Updating data

To maintain the performance of the system, the vehicle software and the navigation map should be updated in periodical intervals.

A navigation map update is available at least once per year. Further information is available in the Infotainment system section.

For vehicle software update consult a workshop.

Other traffic signs

The system detects traffic signs and displays them in specific page of the Driver Information Centre.



This system can be activated or deactivated in the vehicle personalisation ↻ 81.

Driver Information Centre ↻ 77.

System limitations

Traffic sign assistant may not operate properly when:

- Driving on winding or hilly roads.
- Driving during nighttime.
- Driving with snow chains.
- Driving with a trailer.
- The area of the windscreen, where the front camera is located, is not clean or affected by foreign items, e.g. stickers.
- The visibility is limited because of the weather, such as fog, rain, or snow.
- The sun is shining directly into the camera lens.

- Traffic signs are completely or partially covered or difficult to discern.
- Traffic signs are incorrectly mounted or damaged.
- Traffic signs do not comply with the Vienna Convention on Road Signs and Signals.
- The navigation map data is outdated.

Caution

The system is intended to help the driver within a defined speed range to recognise certain traffic signs. Do not ignore traffic signs which are not displayed by the system.

Do not let this special feature tempt you into taking risks when driving.

Always adapt speed regarding road, traffic and weather conditions.

The driver assistance systems do not relieve the driver from full responsibility for vehicle operation.

When driving abroad make sure the vehicle uses the speed unit of the respective country. If necessary, select the correct units in the Info Display.

Lane departure warning



The lane departure warning system supports the driver to avoid unintended leaving of the lane. The front camera observes road edges, as well as the lane markings between

which the vehicle is driving. If the vehicle approaches a road edge or a lane marking, the system warns the driver.

Unintended lane departure is not assumed by the system when the turn lights are operated and during few seconds after turn lights have been switched off.

No warning will be issued with a dynamic driving, i.e. pressure on the brake or accelerator pedal.



When the system recognises an unintended lane departure, the control indicator  flashes yellow.

Warning

This system is a driving aid that cannot, in any circumstances, replace the need for vigilance on the part of the driver.

Activation





If the system is activated, the LED in the button  is not illuminated. To activate the system when the system is deactivated, press .

The system is only operable at vehicle speeds above 40 mph.

Deactivation

To deactivate the system, press  until LED in the button is illuminated.

Fault

In the event of a fault,  and  appear in the Driver Information Centre, accompanied by a display message and a warning chime. Seek the assistance of a workshop.

System limitations

The system performance may be affected by:

- covered camera by snow, ice, slush, mud, dirt, or affected by windscreen damage or foreign items, e.g. stickers
- close vehicles ahead
- banked roads
- winding or hilly roads
- poor lighting conditions
- sudden lighting changes
- shining sun directly into the camera lens
- adverse environmental conditions, e.g. heavy rain, fog, or snow
- vehicle modifications, e.g. tyres
- roads with poor lane markings

Lane keep assist

Lane keep assist supports the driver to avoid unintended leaving of the lane. The front camera observes road edges, as well as the lane markings between which the vehicle is driving. If the vehicle approaches a road edge or a lane marking, the steering wheel is gently turned so that the vehicle turns back into the lane. The driver will notice a turning movement of the steering wheel. Turn steering wheel in same direction, if the system does not steer sufficiently. Turn steering wheel gently into opposite direction, if lane change is intended.

When the system steers to correct the trajectory of the vehicle, , flashes yellow in the Driver Information Centre. Lane keep assist does not continuously steer the vehicle.

Unintended lane departure is not assumed by the system when the turn lights are operated and during few seconds after turn lights have been switched off.

If the system detects that the steering wheel is not held permanently, it interrupts a correction after a short time.

When hands-off driving is detected during a correction a warning message appears in the Driver Information Centre, accompanied by a warning chime. Every further hands-off detection prolongs the warning chime duration.

A lane departure warning in the Driver Information Centre alerts when the system cannot hold the vehicle within the lane and immediate driver's action is required.

Notice

The system may be switched off if it detects lanes which are too narrow, too wide or too curved.

Following preconditions have to be fulfilled that the system corrects:

- vehicle speed must be between 40 mph and 112 mph
- the turn lights are not activated
- the electronic stability control is activated and not in operation



- no plug is connected to the power outlet of the trailer hitch
- no dynamic driving, i.e. pressure on the brake or accelerator pedal
- roads with good lane markings
- no temporary spare wheel is used
- the vehicle is not driven in a tight corner
- no system fault is present which prevents corrections

Depending on version, only lane departure warning system is active, when a system fault is present, a spare wheel used, or e.g. a trailer is attached.

Lane departure warning ⇨ 223.

Activation





Depending on version, the system is automatically activated when ignition is switched on. If the system is activated, the LED in the button  is not illuminated. To activate the system when the system is deactivated, press .

Deactivation

To deactivate the system, press  until LED in the button is illuminated.

Fault

In the event of a fault,  and  appear in the Driver Information Centre, accompanied by a display message and a warning chime. Seek the assistance of a workshop.

System limitations

The system performance may be affected by:

- covered camera by snow, ice, slush, mud, dirt, or affected by windscreen damage or foreign items, e.g. stickers
- close vehicles ahead
- banked roads
- winding or hilly roads
- poor lighting conditions
- sudden lighting changes
- shining sun directly into the camera lens
- adverse environmental conditions, e.g. heavy rain, fog, or snow
- vehicle modifications, e.g. tyres
- roads with poor lane markings

A warning message may appear when the vehicle is travelling in a long straight lane on a smooth road surface even if the driver is holding the steering wheel properly.

Deactivate the system if the system is disturbed by tar marks, shadows, road cracks, temporary or construction lane markings, or other road imperfections.

⚠ Warning

Always keep your attention on the road and maintain proper vehicle position within the lane, otherwise vehicle damage, injury or death could occur.

The system may not keep the vehicle in the lane or give an alert, even if a lane marking is detected.

The steering of the system may not be sufficient to avoid a lane departure.

The system may not detect hands-off driving due to external influences (road condition and surface, weather etc). The driver

has full responsibility to control the vehicle and is always required to keep the hands on the steering wheel while driving.

Using the system while towing a trailer or on slippery roads could cause loss of control of the vehicle and a crash. Switch the system off.

Advanced lane keep assist

⚠ Warning

The system assists the driver in managing the steering, acceleration and braking within the limits of the laws of physics and the capabilities of the vehicle. Some road infrastructure elements or vehicles present on the road may not be properly seen or may be poorly interpreted by the camera and radar, which may lead to an unexpected change in direction, a lack of steering correction and/or inappropriate management of the acceleration or braking.

The activated system observes the lane markings by using the camera located at the top of the windscreen. It steers the vehicle inside the detected lane. The driver will notice a turning movement of the steering wheel.

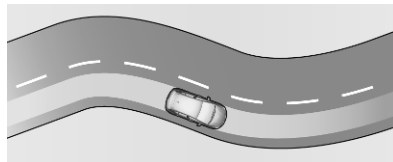

Thus, the current position of the vehicle within the lane is kept.

When the vehicle is steered by the system, ⊕ illuminates green in the Driver Information Centre.

However, the control of the vehicle can be taken over at any time by the driver. Therefore, the driver needs to apply some additional force when turning the steering wheel.

If the system detects that the driver is not holding the steering wheel firmly enough, it triggers a series of gradual alerts. If the interruption takes too long, the system will be deactivated.

⊕ extinguishes in the Driver Information Centre. The system has to be reactivated again by the driver. Adaptive cruise control ↪ 192.

Required preconditions

- Adaptive cruise control must be activated.
- The driver must hold the steering wheel.
- The turn lights are not activated.
- The Electronic Stability Control is activated and not in operation.
- No plug is connected to the power outlet of the trailer hitch.
- No dynamic driving is detected, i.e. pressure on the brake or accelerator pedal.
- Roads have good lane markings.
- No temporary spare wheel is used.
- The vehicle is not driven in a tight corner.
- No system fault is present which prevents corrections.

Activation



Press  to activate the system. The LED in the button is illuminated and ⊕ illuminates green in the Driver Information Centre.

Deactivation

To deactivate the system, press . The LED in the button and ⊕ in the Driver Information Centre are extinguished.



Pausing / suspending the system

Advanced lane keep assist may be paused or suspended in the following situations:

- The Electronic Stability Control is in operation or it has been deactivated.
- At least one of the lane markings is not detected by the system for several seconds. The system will be reactivated once the operating conditions are regained.
- The turn lights are activated.
- Driving outside the lane limits.
- The steering wheel is held too tight or moved too dynamically.
- The brake pedal or the accelerator pedal are applied.
- The adaptive cruise control is paused.
- The road is too narrow or wide.
- The lateral acceleration in curves is too high.

⊕ illuminates grey in the Driver Information Centre.

Fault

In the event of a fault,  and  appear yellow in the Driver Information Centre, accompanied by a display message and a warning chime. Seek the assistance of a workshop.

System limitations

The system performance may be affected by:

- covered camera by snow, ice, slush, mud, dirt, or affected by windscreen damage or foreign items, e.g. stickers
- close vehicles ahead
- banked roads
- winding or hilly roads
- poor lighting conditions
- sudden lighting changes
- shining sun directly into the camera lens
- adverse environmental conditions, e.g. heavy rain, fog, or snow

- vehicle modifications, e.g. tyres
- roads with poor lane markings

A warning message may appear when the vehicle is travelling in a long straight lane on a smooth road surface even if the driver is holding the steering wheel properly.

Deactivate the system if the system is disturbed by tar marks, shadows, road cracks, temporary or construction lane markings, or other road imperfections.

 Warning

Always keep your attention on the road and maintain proper vehicle position within the lane, otherwise vehicle damage, injury or death could occur.

The system may not keep the vehicle in the lane or give an alert, even if a lane marking is detected.

The steering of the system may not be sufficient to avoid a lane departure.

The system may not detect hands-off driving due to external influences (road condition and surface, weather etc). The driver has full responsibility to control the vehicle and is always required to keep the hands on the steering wheel while driving.

Using the system while towing a trailer or on slippery roads could cause loss of control of the vehicle and a crash. Switch the system off.

Driver alert

The driver alert system monitors the driving time and the vigilance of the driver. Monitoring the vigilance of the driver is based on the trajectory variations of the vehicle compared to the lane markings.

The system cannot replace the need for vigilance on the part of the driver. Taking a break is recommended as soon as feeling tired or at least every two hours. Do not drive when feeling tired.

Activation or Deactivation

The system can be activated or deactivated in the vehicle personalisation ↗ 81.

When the system is deactivated  may illuminate in the Driver Information Centre.

The system is automatically activated when ignition is switched on.

Driving time alert

The driver gets notified by a pop-up reminder symbol  in the Driver Information Centre simultaneously with an acoustic alert if the driver has not taken a break after two hours of driving at a speed above 40 mph. The alert is repeated hourly until the vehicle is stopped, no matter how vehicle speed evolves.

The counting of driving time alert is reset when the ignition has been switched off for a few minutes or the driver's seat belt has been unfastened and the driver's door has been opened.

Driver drowsiness detection

The system monitors the driver's level of vigilance at speeds above 40 mph. A camera at the top of the windscreen detects variations in trajectory compared to the lane markings.

The system may perform a learning procedure for up to 30 minutes after the start of the monitoring. During this period, the driver's individual driving behaviour is analysed and no alert is given.

If the trajectory of the vehicle suggests a certain level of drowsiness or inattention by the driver, the system triggers the first level of alert. The driver is notified by a message and an audible signal is given.

After three first level alerts, the system triggers a new alert with a message, accompanied by a more pronounced audible signal.

In certain driving conditions such as poor road surface or strong winds etc., the system may give alerts independent of the driver's level of vigilance.



The driver drowsiness detection is reinitialised in the following situations:

- the ignition has been switched off for a few minutes
- the speed remains below 40 mph for a few minutes
- the driver's seat belt has been unfastened and the driver's door has been opened

System limitations

In the following situations, the system may not operate properly or even not operate at all:

- poor visibility caused by inadequate lighting of the roadway, falling snow, heavy rain, dense fog etc.
- dazzle caused by headlamps of oncoming vehicles, low sun, reflections on damp roads, leaving a tunnel, alternating shade and light etc.
- no lane markings detected or multiple lane markings due to roadworks
- close vehicles ahead

- winding roads or narrow roads
- advanced lane keep assist is active
- covered camera by snow, ice, slush, mud, dirt, or affected by windscreen damage or foreign items, e.g. stickers,  may appear in the Driver Information Centre, accompanied by a message
- in the event of a system fault,  may appear in the Driver Information Centre, accompanied by a message and a warning chime

Charging

General information

Warning

Persons with a pacemaker should consult a doctor for possible precautions.

Charging the vehicle's high voltage battery depends upon several factors:

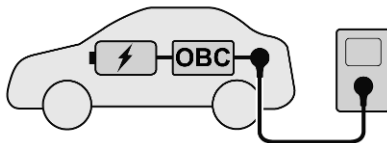

- high voltage battery of the vehicle
- internal onboard charger (OBC)
- charging cable
- external charging device

The charging cable connects the vehicle with an external charging device providing electric power. This

may be a domestic electrical outlet, a Green'Up socket, a wall box or a public charging station.

The high voltage battery is charged with direct current (DC) only. When charging the vehicle with alternating current (AC), AC has to be converted into DC. This is done by the vehicle's onboard charger. The onboard charger is available with 7.4 kW (single-phase) and 11 kW (3-phase).

If the vehicle is charged at a public DC charging station, no DC conversion is required. The high voltage battery can be directly charged with DC provided by the DC charging station.

The speed of charging the vehicle's high voltage battery depends upon the weakest element of the charging chain. To achieve the maximum charging speed, charging cable and charging device have to be attuned to each other.

Notice

Make sure that the charging cable used fits to the vehicle's onboard charger.

Charging types ⇨ 231.

Charging cable ⇨ 238.

Electric power consumption and range

The electric power consumption (combined) is within a range of 15.17 to 12.77 kWh/100 km.

The range is up to 250 miles.

For the values specific to your vehicle, refer to the EEC Certificate of Conformity provided with your vehicle or other national registration documents.

The determination of electric power consumption is regulated by directive R (EC) No. 715/2007 and No. 2017/1151 (in the latest applicable version).

Charging types

There are different types of charging the vehicle's high voltage battery.

Charging at wallboxes



A wallbox is a charging unit for private households. It provides a charging cable which has to be connected to the vehicle's charging port. Some wallboxes do not provide a charging cable. In this case, a separate charging cable is required which has to be connected to both the wallbox and the charging port of the vehicle.

Charging time may take approx. 5 hours with a charging power of 11 kW or 7.5 hours with a charging power of 7.4 kW.

Charging at charging stations

Charging stations may provide alternating current (AC) or direct current (DC). Charging time may vary depending on the charging station, DC charging stations provide the fastest charging. To charge the

vehicle's battery, the charging cable of the charging station has to be connected to the charging port of the vehicle.



- AC charging station: Charging time may take approx. 5 hours with a charging power of 11 kW or 7.5 hours with a charging power of 7.4 kW.



- DC charging station: Up to approx. 80% of battery capacity may be charged in approx. 30 minutes at a charging power of 100 kW.

Charging at domestic electrical outlets



The vehicle's high voltage battery can be charged at a domestic electrical outlet. Connect the charging cable to the vehicle's charging port and to the domestic electrical outlet.

Charging time may take approx. 30 hours with a charging power of 1.8 kW.

Charging cable

Depending on the charging type, different charging cables are used.

⚠ Warning

Improper use of portable charging cables may cause a fire, electrical shock, or burns, and may result in damage to property, serious injury, or death.

- Do not use extension cables, multi-outlet power strips, splitters, grounding adaptors, surge protectors, or similar devices.
- Do not use an electrical socket that is worn or damaged, or one that will not hold the plug firmly in place.
- Do not immerse the charging cable into any liquid.
- Do not use an electrical socket that is not properly grounded.
- Do not use an electrical socket that is on a circuit with other electrical loads.

⚠ Warning

Read all the safety warnings and instructions before using this product. Failure to follow the warnings and the instructions may result in electric shock, fire, and / or serious injury.

Never leave children unattended near the vehicle while the vehicle is charging and never allow children to play with the charging cable.

If the plug provided does not fit the electrical outlet, do not modify the plug. Arrange for a qualified electrician to inspect the electrical outlet.

Do not put fingers into the electric vehicle connector.

⚠ Danger

There is a risk of electric shock that may cause personal injury or death.

Do not use the charging cable if any part of the charging cable is damaged.

Do not open or remove the charging cable cover.

Service by qualified personnel only. Connect the charging cable to a properly grounded outlet with cables that are not damaged.

Basic domestic cable (mode 2) / enhanced domestic cable (mode 2)

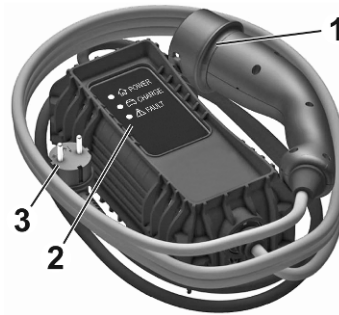

1. Vehicle plug
2. Status indicators
3. Wall plug

Basic domestic cables (mode 2) are used for charging at domestic electrical outlets. A basic domestic cable (mode 2) consists of a vehicle plug, a control box and a plug for the domestic electrical outlet. The control box has an integrated charge controller and several LEDs indicating the charging status.

Enhanced domestic cables (mode 2) are similar to basic domestic cables (mode 2). However, the charging performance of enhanced domestic cables (mode 2 charging) is better than the charging performance of basic domestic cables (mode 2). Enhanced domestic cables (mode 2) are used at Green'Up sockets which have to be installed by a certified electrician at the customer's site.

Charging cable status indicators

After plugging in the charging cable, it will perform a quick self test and all status indicators illuminate for a moment. For the functions of the status indicators, refer to the manual of the charging cable manufacturer.

Important information about portable electric vehicle charging

- Charging an electric vehicle can stress a building's electrical system more than a typical household appliance.
- Before you plug in to any electrical outlet, have a qualified electrician inspect and verify the

electrical system (electrical outlet, wiring, junctions and protection devices) for heavy-duty service at a 10 A continuous load.

- Electrical outlets may wear out with normal usage or be damaged over time, making them unsuitable for electric vehicle charging.
- Check the electrical outlet / plug while charging and discontinue use if the electrical outlet / plug is hot, then have the electrical outlet serviced by a qualified electrician.
- When outdoors, plug into an electrical outlet that is weather-proof while in use.
- Mount the charging cable to reduce strain on the electrical outlet / plug.

Mode 3 charging cable



1. Vehicle plug
2. Plug for wall box / AC charging station

Mode 3 charging cables are used for charging at wall boxes and AC charging stations. A mode 3 charging cable provides a vehicle plug and a plug for the wall box / AC charging station. Wall boxes / AC charging stations may provide an integrated mode 3 charging cable. For more information on the mode 3 charging cable, refer to the manual of the charging cable manufacturer.

Mode 4 charging cable

Notice

Only use DC charging cables shorter than 30 metres.

Mode 4 charging cables are used for DC charging. Since mode 4 charging cables are integrated within DC charging stations, they only provide a vehicle plug.

Charging

⚠ Warning

Persons with a pacemaker or similar devices should consult a doctor for possible precautions.

If in doubt, during charging do not remain inside or near the vehicle, near the charging cable or the charging unit.

In order to ensure the compatibility of plug and outlet, different labels are used. The labels are located on the inside of the vehicle's charging port flap. Make sure to connect only a cable of the same type.



Type 2 plug or outlet used for AC charging



FF plug or outlet used for DC charging

Warning

Avoid any entry of fluids into the charging port of the vehicle, the vehicle plug of the charging cable and the domestic electrical outlet.

When charging at a public AC charging station / public DC charging station, follow the instructions for the use of the respective charging station. Public AC charging stations

may not provide an integrated charging cable. In this case, a portable mode 3 charging cable is required.

Warning

When charging at a domestic electrical outlet, only use an outlet which is properly grounded and protected by a 30 mA differential switch.

Only use a domestic electrical outlet protected by a circuit breaker adapted to the amperage of the electrical circuit.

Have a qualified electrician check the electrical installation to be used. The installation has to be in compliance with national standards and compatible with the vehicle.

When using a dedicated domestic electrical outlet, have it installed by a qualified electrician.

Make sure that the electrical outlet, the plug and the cable do not support the weight of the control box.

1. Shift into **P** and switch off the vehicle.



2. Push the charging port flap to release it.
3. If necessary, take the charging cable out of the load compartment.
4. If necessary, plug in the plug of the charging cable into the corresponding port of the external power source.

Charging cable ↗ 238.

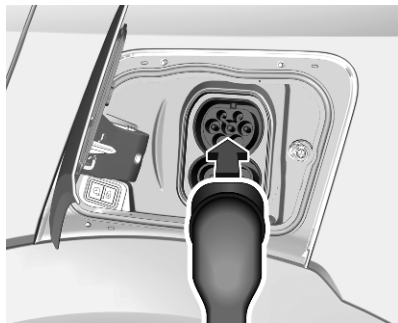

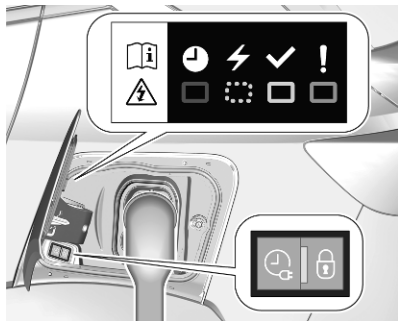

5. Plug in the vehicle plug of the mode 3 charging cable into the charging port of the vehicle.

Charging status ↗ 238.

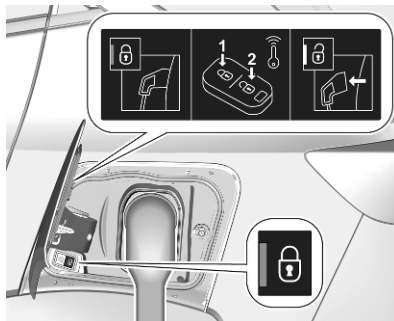

The start of charging is indicated by the green flashing of the status indicator at the charging port and at the control box of the charging cable, if available.



Once charging, the vehicle plug will be locked to the charging port and cannot be disconnected while charging is active.  indicator illuminates.

Charging types ↗ 231.

Cancelling the charging process

Notice

At public charging stations, the cancelling and subsequent resuming of the charging process may cause additional costs.

Once the charging process has started, only the driver's door can be unlocked without cancelling the charging process. Therefore, activate the driver's door only function in the vehicle personalisation.

Press  on the remote control to cancel the charging process at any time.

Press  twice to cancel the charging process at any time if the function **driver's door only** is activated in the vehicle personalisation.

Central locking system ↗ 10.

Vehicle personalisation ↗ 81.

Stop charging

The high voltage battery is fully charged if the status indicator on the charging port permanently illuminates green.

1. Unlock the vehicle before removing the vehicle plug from the charging port.

If the vehicle is already unlocked, lock the vehicle and unlock it again.

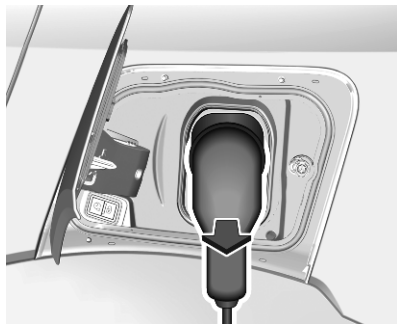

2. Disconnect the vehicle plug of the charging cable from the charging port within 30 seconds after unlocking.

3. Close the charging port flap by pressing firmly in the centre to latch properly.
4. Disconnect the charging cable from the external power source.
5. If necessary, store the charging cable in the load compartment.

While the charging cable is plugged into the vehicle, the vehicle cannot be driven.

Programmable charging

By default, charging starts as soon as the charging cable is connected to the charging port of the vehicle. It is also possible to schedule charging using the Info Display.

Programmable charging is only possible when charging at a domestic electrical outlet / Green'Up socket or a wall box.

Programmable charging is also available via the MyVaughall App.

Notice

On vehicles without integrated navigation system, programmable charging can only be used via the MyVaughall App.



1. Press .
2. Select **Charge**.



3. Press .
4. Define the number of hours and minutes after which the loading process starts.
5. Press **OK**.
6. Plug in the vehicle.

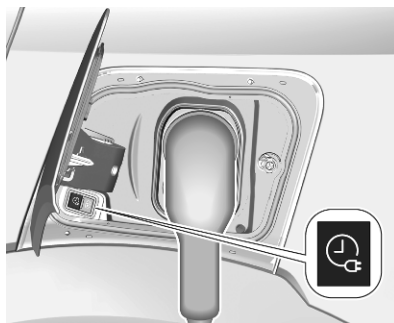

7. Within 1 minute, press  to activate programmable charging.
8. Depending on version, lock the vehicle.

The status indicator illuminates blue indicating that programmable charging is active.

Charging ⇨ 234.

Charging status ⇨ 238.

Charging status



If the vehicle is plugged in and the ignition is switched off, the charging status indicator indicates the following:

- Illuminates white: welcome lighting when charging port flap is opened
- Flashes white: charging in preparation
- Illuminates green: charging complete
- Flashes green: charging in process

- Illuminates red: charging fault
- Illuminates blue: programmable charging active

A charging fault has occurred if the vehicle is plugged in and the charging status indicator is off.

Further charging status indicators are located on the control box of the basic domestic cable (mode 2) / enhanced domestic cable (mode 2).

Charging cable ⇨ 232.

Programmable charging ⇨ 237.

Fuel

Fuel for petrol engines

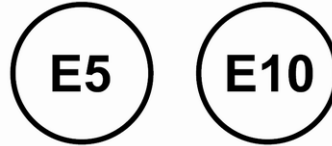

Only use unleaded fuel that complies with European standard EN 228 or E DIN 51626-1 or equivalent.

The engine is capable of running with fuel that contains up to 10% ethanol (e.g. named E10).

Use fuel with the recommended octane rating. A lower octane rating can reduce engine power and torque and slightly increases fuel consumption.

Caution

Do not use fuel or fuel additives that contain metallic compounds such as manganese-based additives. This may cause engine damage.

Caution

Use of fuel with a lower octane rating than the lowest possible rating could lead to uncontrolled combustion and engine damage.

The engine specific requirements regarding octane rating are given in the engine data overview ⇨ 288. A country-specific label at the fuel filler flap can supersede the requirement. In certain countries, the use of a particular fuel, e.g. a specific octane rating, may be required to ensure proper engine operation.

Fuel for diesel engines

The Diesel engines are compatible with bio-fuels that conform to current and future European standards and can be obtained from filling stations:



Diesel fuel that meets standard EN590 mixed with a biofuel that meets standard EN14214 (possibly containing up to 7% Fatty Acid Methyl Ester).



Diesel fuel that meets standard EN16734 mixed with a biofuel that meets standard EN14214 (possibly containing up to 10% Fatty Acid Methyl Ester).



Paraffinic Diesel fuel that meets standard EN15940 mixed with a biofuel that meets standard EN14214 (possibly containing up to 7% Fatty Acid Methyl Ester).

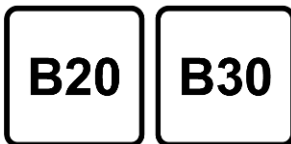

The use of B20 or B30 fuel meeting standard EN16709 is possible in your Diesel engines. However, this use, even occasional, requires strict

application of the special servicing conditions referred to as "Arduous conditions".

For more information, seek the assistance of a workshop.

Caution

The use of any other type of (bio) fuel (vegetable or animal oils, pure or diluted, domestic fuel etc.) is strictly prohibited (risk of damage to the engine and fuel system).

Notice

The only Diesel additives authorised for use are those that meet the B715000 standard.

Low temperature operation

At temperatures below 0 °C, some diesel products with biodiesel blends may clog, freeze or gel, which may affect the fuel supply system. Starting and engine operation may not work properly. Make sure to fill winter grade diesel fuel at ambient temperatures below 0 °C.

Arctic grade diesel fuel can be used at extremely low temperatures below -20 °C. Using this fuel grade in warm or hot climates is not recommended and may cause engine stalling, poor starting or damage on the fuel injection system.

Refuelling

⚠ Danger

Before refuelling, switch off ignition and any external heaters with combustion chambers.

Follow the operating and safety instructions of the filling station when refuelling.

⚠ Danger

Fuel is flammable and explosive. No smoking. No naked flames or sparks.

If you can smell fuel in your vehicle, have the cause of this remedied immediately by a workshop.

A label with symbols at the fuel filler flap is indicating the allowed fuel types. In Europe the pump nozzles of the filling stations are marked with these symbols. Refuel only the allowed fuel type.

Caution

In case of misfuelling, do not switch on ignition.

Fuel filler flap is located at left rear side of vehicle.

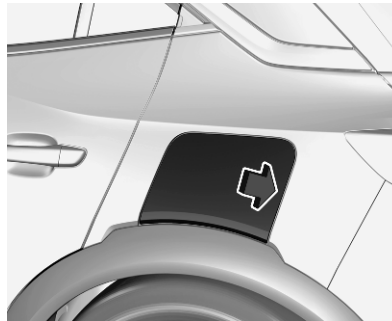

The fuel filler flap can only be opened if the vehicle is unlocked. Release the fuel filler flap by pushing the flap.

Petrol and diesel refuelling

Notice

Diesel-engined vehicles may be equipped with a mis-fuel inhibitor that prevents the refuelling with petrol.

To open, turn the cap slowly anticlockwise.

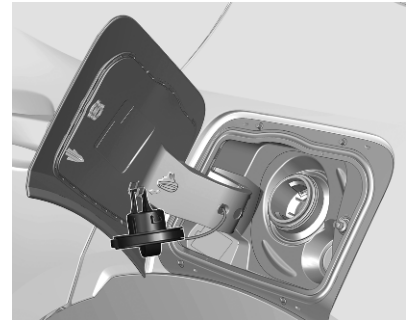

The fuel filler cap can be attached to the hook on the fuel filler flap.

Place the nozzle in straight position to the filler neck and press with slight force to insert.

To refuel, switch on pump nozzle.

After the automatic cut-off, the tank can be topped up by operating the pump nozzle a maximum of two more times.

Caution

Wipe off any overflowing fuel immediately.

To close, turn the fuel filler cap clockwise until it clicks.

Close the flap and allow it to engage.

Fuel filler cap

Only use genuine fuel filler caps.

Diesel-engined vehicles have special fuel filler caps.

Fuel consumption - CO₂-Emissions

The fuel consumption (combined) is within a range of 47.1 to 51.4 mpg.

The CO₂ emission is within a range of 148 to 113 g/km.

General information

For the values specific to your vehicle, refer to the EEC Certificate of Conformity provided with your vehicle or other national registration documents.

The determination of fuel consumption is regulated by directive R (EC) No. 715/2007 and No. 2017/1151 (in the latest applicable version).

The specification of CO₂ emission is also a constituent of the directive.

The figures given must not be taken as a guarantee for the actual fuel consumption of a particular vehicle. Furthermore, fuel consumption is dependent on personal driving style as well as road and traffic conditions.

All values are based on the EU base model with standard equipment.

The calculation of fuel consumption takes into account the vehicle's kerb weight, ascertained in accordance with the regulations. Optional equipment may result in slightly

higher fuel consumption and CO₂ emission levels and a lower maximum speed.

Trailer hitch

General information

Caution
For new vehicles, only tow a trailer after having driven at least 620 miles.

Only use towing equipment that has been approved for your vehicle.

Entrust retrofitting of towing equipment to a workshop. It may be necessary to make changes that affect the cooling system, heat shields or other equipment.

Trailers equipped with LED lights are not suitable for the wiring harness of this trailer hitch.

Fitting of towing equipment could cover the opening of the towing eye. If this is the case, use the coupling ball bar for towing. Always keep the coupling ball bar in the vehicle to have it on hand if needed.

Driving characteristics and towing tips

Before attaching a trailer, lubricate the coupling ball. However, do not do so if a stabiliser, which acts on the coupling ball, is being used to reduce snaking movements.

During trailer towing do not exceed a speed of 50 mph. A maximum speed of 60 mph is only appropriate if an oscillation damper is used and the permissible gross trailer weight does not exceed the vehicle's curb weight.

For trailers with low driving stability and caravan trailers, the use of an oscillation damper is strongly recommended.

If the trailer starts snaking, drive more slowly, do not attempt to correct the steering and brake sharply if necessary.

When driving downhill, drive in the same gear as if driving uphill and drive at a similar speed.

Adjust tyre pressure to the value specified for full load ↗ 291.

Trailer towing

Trailer loads

The permissible trailer loads are vehicle and engine-dependent maximum values which must not be exceeded. The actual trailer load is the difference between the actual gross weight of the trailer and the actual coupling socket load with the trailer coupled.

The permissible trailer loads are specified in the vehicle documents. In general, they are valid for gradients up to 12%.

The permissible trailer load applies up to the specified incline and at sea level. Since engine power decreases as altitude increases due to the air becoming thinner, therefore reducing climbing ability, the permissible gross train weight also decreases by 10% for every 1000 m of altitude. The gross train weight does not have to be reduced when driving on roads with slight inclines (less than 8%, e.g. motorways).

The permissible gross train weight must not be exceeded. This weight is specified on the identification plate ⇨ 285.

Vertical coupling load

The vertical coupling load is the load exerted by the trailer on the coupling ball. It can be varied by changing the weight distribution when loading the trailer.

The maximum permissible vertical coupling load (61 kg) is specified on the towing equipment identification plate and in the vehicle documents.

Always aim for the maximum vertical coupling load, especially in the case of heavy trailers. The vertical coupling load should never fall below 25 kg.

Rear axle load

When the trailer is coupled and the towing vehicle fully loaded, the permissible rear axle load (see identification plate or vehicle documents) may be exceeded by 60 kg, the gross vehicle weight rating must not be exceeded. If the permissible rear axle load is exceeded, a maximum speed of 60 mph applies.

Vehicle care

General Information	245
Accessories and vehicle modifications	245
Vehicle storage	248
End-of-life vehicle recovery	249
Vehicle checks	250
Performing work	250
Bonnet	251
Engine oil	251
Engine coolant	253
Washer fluid	254
Brakes	254
Brake fluid	254
Vehicle battery	254
High voltage battery	257
Diesel fuel system bleeding	257
Wiper blade replacement	258
Bulb replacement	258
LED headlights	258
Front fog lights	258
Tail lights	259
Number plate light	259
Interior lights	259
Electrical system	260
Fuses	260

Vehicle tools	260
Tools	260
Wheels and tyres	261
Winter tyres	261
Tyre designations	261
Tyre pressure	262
Tyre deflation detection system	263
Tread depth	263
Changing tyre and wheel size	264
Wheel covers	264
Tyre chains	265
Tyre repair kit	265
Wheel changing	268
Spare wheel	269
Jump starting	273
Towing	274
Towing the vehicle	274
Towing another vehicle	276
Appearance care	276
Exterior care	276
Interior care	278
Floor mats	278

General Information

Accessories and vehicle modifications

We recommend the use of genuine parts and accessories and factory approved parts specific for your vehicle type. We cannot assess or guarantee reliability of other products - even if they have a regulatory or otherwise granted approval.

Any modification, conversion or other changes made to standard vehicle specifications (including, without limitation, software modifications, modifications of the electronic control units) may invalidate the warranty offered by Vauxhall. Furthermore, such changes may affect driver assistance systems, may impact fuel or electric power consumption, CO₂ emissions and other emissions of the vehicle and cause the vehicle to no longer conform to the operating permit, impacting the validity of your vehicle registration.

Caution

Access to the diagnostic socket associated with the on-board electronics is reserved for qualified technicians and approved tools.

Caution

When transporting the vehicle on a train or on a recovery vehicle, the mud flaps might be damaged.

Cold protection covers

It is recommended to have the cold protection covers installed by a workshop.

Caution

The cold protection covers must be removed when one of the following conditions occurs:

- The ambient temperature is above 10 °C.
- The vehicle is towing a trailer.
- The vehicle is driven at speeds above 75 mph.

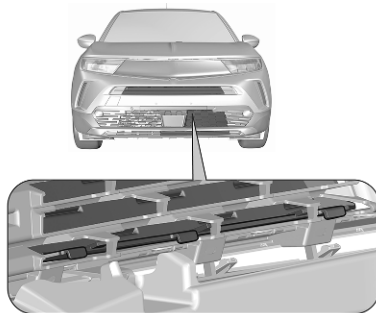
Installation

1. Place the lower part of the respective cold protection cover on the inside of the grille as shown.

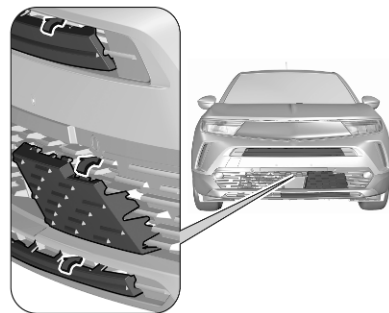

2. Press from the outside the upper part of the cold protection covers against the slat of the grille.
3. Ensure that the cold protection covers are fixed securely.

Deinstallation

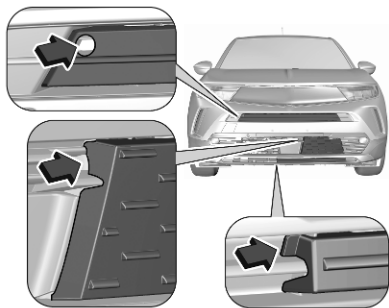

Remove the cold protection covers by gently pulling them out at the indicated positions.

Mobile phones and CB radio equipment

The vehicle specific installation instructions and the operating guidelines of the mobile phone and hands-free manufacturer must be observed when installing and operating a mobile telephone. Failure to do so could invalidate the vehicle type approval (EU directive 95/54/EC).

Recommendations for fault-free operation:

- Professionally installed exterior antenna to obtain the maximum range possible.
- Maximum transmission power 10 W.
- Installation of the phone in a suitable spot, consider the area in which the airbag inflates ⇨ 36.

Seek advice on predetermined installation points for the external antenna or equipment holder and ways of using devices with a transmission power exceeding 10 W.

Use of a hands-free attachment without external antenna with mobile telephone standards GSM 900/1800/1900 and UMTS is only permitted if the maximum transmission power of the mobile telephone is 2 W for GSM 900 or 1 W for the other types.

For reasons of safety, do not use the phone while driving. Even use of a hands-free set can be a distraction while driving.

⚠ Warning

Operation of radio equipment and mobile telephones which fail to meet above mentioned mobile telephone standards is only permitted using an antenna located outside of the vehicle.

Caution

Mobile telephones and radio equipment may lead to malfunctions in the vehicle electronics when operated inside the vehicle with no exterior antenna, unless the above mentioned regulations are observed.

Vehicle storage

Storage for a long period of time

If the vehicle is to be stored for several months:

- Wash the vehicle.
- Have the wax in the engine compartment and underbody checked.
- Clean and preserve the rubber seals.
- Fill up fuel tank completely.
- Change the engine oil.
- Drain the washer fluid reservoir.
- Check the coolant antifreeze and corrosion protection.
- Adjust tyre pressure to the value specified for full load.
- Park the vehicle in a dry, well ventilated place. Engage first or reverse gear or set selector lever to **P**. Prevent the vehicle from rolling.
- Do not apply the parking brake.
- Open the bonnet, close all doors and lock the vehicle.

Storage for a long period of time (BEV)

If the vehicle is to be stored for several months:

- Wash the vehicle.
- Have the wax in the engine compartment and underbody checked.
- Clean and preserve the rubber seals.
- Drain the washer fluid reservoir.
- Check the coolant antifreeze and corrosion protection.
- Adjust tyre pressure to the value specified for full load.
- Park the vehicle in a dry, well ventilated place. Engage first or reverse gear or set selector lever to **P**. Prevent the vehicle from rolling.
- Do not apply the parking brake.
- Open the bonnet, close all doors and lock the vehicle.

Up to four weeks

Plug in the charging cable.

Four weeks to twelve months

- Discharge the high voltage battery until 30 percent remain on the battery range indicator (battery symbol) on the Driver Information Centre.
- Do not plug in the charging cable.
- Always store the vehicle in a place with temperatures between -10°C and 30°C .
- Vehicle storage at extreme temperatures may cause damage to the high voltage battery.
- Remove the black negative (-) cable from the 12 V vehicle battery and attach a trickle charger to the vehicle battery terminals or keep the 12 V vehicle battery cables connected and trickle charge from the positive (+) and negative (-) terminals in the engine compartment.
- Every three months, check the battery's state of charge. If the state of charge is below 30 percent, recharge the battery to 30 percent.

Putting back into operation

When the vehicle is to be put back into operation:

- Connect the clamp to the negative terminal of the vehicle battery. Initialise the power windows ⇨ 23.
- Check tyre pressure.
- Fill up the washer fluid reservoir.
- Check the engine oil level.
- Check the coolant level.
- Fit the number plate if necessary.

Putting back into operation (BEV)

When the vehicle is to be put back into operation:

- Connect the clamp to the negative terminal of the vehicle battery. Initialise the power windows ⇨ 23.
- Check tyre pressure.
- Fill up the washer fluid reservoir.
- Check the coolant level.
- Fit the number plate if necessary.

Propulsion types ⇨ 4.

End-of-life vehicle recovery

Information on end-of-life vehicle recovery centres and the recycling of end-of-life vehicles is available on our website, where legally required. Only entrust this work to an authorised recycling centre.



High voltage battery

The high voltage battery is designed for the life of the vehicle if the recommendations are followed. If it becomes necessary to replace the high voltage battery, contact a workshop for instructions on its disposal. Improper disposal carries

the risk of severe burns, electric shock, and damage to the environment.

Recommendations ⇨ 257.

Vehicle checks

Performing work

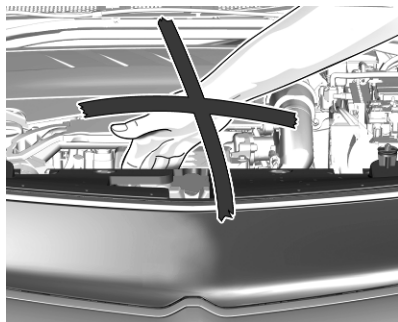

⚠ Warning

Only perform engine compartment checks when the ignition is off.
The cooling fan may start operating even if the ignition is off.

⚠ Danger

The ignition system uses extremely high voltage. Do not touch.



⚠ Danger

Electric or Hybrid versions:
Never try to perform maintenance work on high voltage components yourself. You may be injured and the vehicle may be damaged. Service and repair of these high voltage components should only be performed by a trained service technician with proper knowledge and tools. Exposure to high voltage may cause shock, burns, and even death. The high voltage

components in the vehicle can only be serviced by technicians with special training.

High voltage components are identified by labels. Do not remove, open, take apart, or modify these components. High voltage cable or wiring has orange covering. Do not probe, tamper with, cut, or modify high voltage cable or wiring.

⚠ Warning

Electric or Hybrid versions:
Only perform engine compartment checks when the vehicle is off.
The cooling fan may start operating even if the vehicle is off.

Caution

Electric or Hybrid versions:
Even small amounts of contamination to the liquids can cause damage to vehicle systems.

Do not allow contaminants to contact the fluids, reservoir caps, or dipsticks.

Bonnet

Opening

Caution

Before opening the bonnet, deactivate the stop-start system
 ⇨ 167

Open the driver's door.



Pull the release lever and return it to its original position.

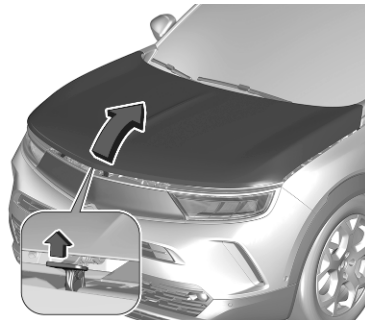

Push the safety catch upwards and open the bonnet.

Closing



Lower the bonnet and let it fall into the latch from a low height (20-25 cm). Check that the bonnet is engaged.

Caution

Do not press the bonnet into the latch to avoid dents.

Engine oil

Check the engine oil level manually on a regular basis to prevent damage to the engine. Ensure that the correct specification of engine oil is used.

Recommended fluids and lubricants
⇨ 283.

The maximum engine oil consumption is 0.6 l per 600 miles.

Check with the vehicle on a level surface. The engine must be at operating temperature and switched off for at least 5 min.

Caution

It is the owner's responsibility to maintain the proper level of an appropriate quality oil in the engine.

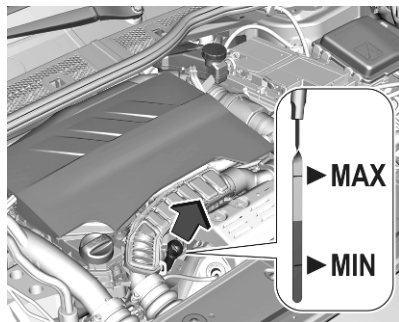

Different dipsticks are used depending on engine variant.

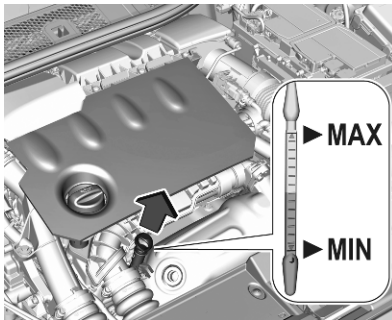

Pull out the dipstick, wipe it clean, reinsert it fully, pull out and read the engine oil level.

When the engine oil level has dropped to the **MIN** mark, top up the engine oil.

We recommend the use of the same grade of engine oil that was used at last change.

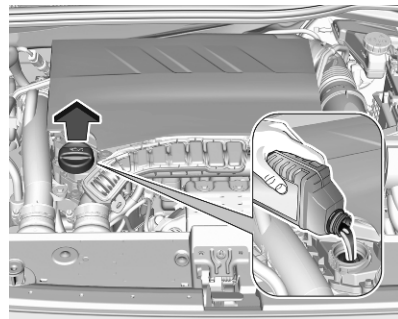

The engine oil level must not exceed the **MAX** mark on the dipstick.

Caution

Overfilled engine oil must be drained or suctioned out. If the oil exceeds the maximum level, do not start the vehicle and contact a workshop.

Capacities ⇨ 290.

Fit the cap on straight and tighten it.

Engine coolant

Coolant level BEV

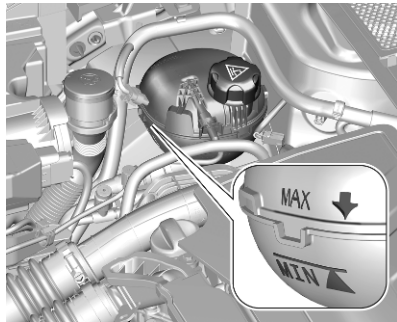

If the coolant level is at the **MIN** mark or below, seek the assistance of a workshop to have the engine coolant topped up.

Caution

Using the wrong engine coolant can cause severe damages to the high voltage battery. Only experienced mechanics are allowed to open the coolant reservoir and to top up coolant.

Propulsion types ⇨ 4.

Coolant level ICE

The factory filled coolant provides freeze protection down to approx. -37 °C.

Caution

Only use approved antifreeze.

Coolant and antifreeze ⇨ 283.

Caution

Too low a coolant level can cause engine damage.

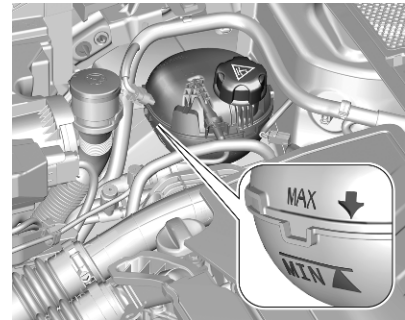

If the cooling system is cold, the coolant level should be above the **MIN** mark. Top up if the level is low.

⚠ Warning

Allow the engine to cool before opening the cap. Carefully open the cap, relieving the pressure slowly.

To top up, use a 1:1 mixture of released coolant concentrate mixed with clean tap water. If no coolant concentrate is available, use clean tap water. Install the cap tightly. Have

the coolant concentration checked and have the cause of the coolant loss remedied by a workshop.

Washer fluid

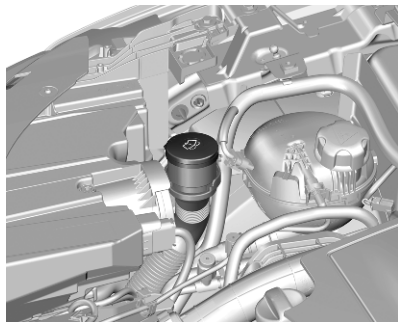

Fill with clean water mixed with a suitable quantity of approved windscreen washer fluid which contains antifreeze.

Caution

Only washer fluid with a sufficient antifreeze concentration provides protection at low temperatures or a sudden drop in temperature.

Washer fluid ↪ 283.

Brakes

Depending on the driving style, the brake wear may vary significantly. The brake wear may increase when the vehicle is driven over short distances, e.g. in the city.

It may be necessary to have the condition of the brakes checked, even between vehicle services.

Unless there is a leak in the circuit, a drop in the brake fluid level indicates that the brake pads are worn.

Once new brake linings are installed, do not brake unnecessarily hard for the first few journeys.

Brake fluid

⚠ Warning

Brake fluid is poisonous and corrosive. Avoid contact with eyes, skin, fabrics and painted surfaces.

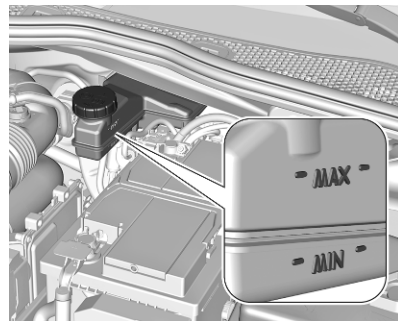

The brake fluid level must be between the **MIN** and **MAX** marks.

If fluid level is below **MIN** seek the assistance of a workshop.

Brake and clutch fluid ↪ 283.

Vehicle battery

The vehicle battery is maintenance-free provided that the driving profile allows sufficient charging of the battery. Short-distance-driving and frequent engine starts can discharge the battery. Avoid the use of unnecessary electrical consumers.



Batteries do not belong in household waste. They must be disposed of at an appropriate recycling collection point.

Laying up the vehicle for more than four weeks can lead to battery discharge. Disconnect the clamp from the negative terminal of the vehicle battery.

Ensure the ignition is switched off before connecting or disconnecting the vehicle battery.

Battery discharge protection ⇨ 92.

Replacing the vehicle battery

Notice

Any deviation from the instructions given in this section may lead to temporary deactivation or disturbance of the stop-start system.

When the vehicle battery is being replaced, please ensure that there are no open ventilation holes in the vicinity of the positive terminal. If a ventilation hole is open in this area, it must be closed off with a dummy cap, and the ventilation in the vicinity of the negative terminal must be opened.

Ensure that the battery is always replaced by the same type of battery.

The vehicle battery has to be replaced by a workshop.

Stop-start system ⇨ 167.

Charging the vehicle battery

⚠ Warning

On vehicles with stop-start system, ensure that the charging potential does not exceed 14.6 V when using a battery charger. Otherwise the vehicle battery may be damaged.

Jump starting ⇨ 273.

Discharge protection

Battery voltage

When the vehicle battery voltage is running low, a warning message will appear in the Driver Information Centre.

When the vehicle is being driven, the load reduction function temporarily deactivates certain functions, such as the air conditioning, the heated rear window, heated steering wheel, etc.

The deactivated functions are reactivated automatically as soon as conditions permit.

Idle boost

If charging of the vehicle battery is required due to battery condition, the power output of the generator must be increased. This will be achieved by an idle boost which may be audible.

A message appears in the Driver Information Centre.

Power outlet

The power outlets are deactivated in the event of low vehicle battery voltage.

Warning label



Meaning of symbols:

- No sparks, naked flames or smoking.
- Always shield eyes. Explosive gases can cause blindness or injury.
- The vehicle battery contains sulphuric acid which could cause blindness or serious burn injuries.
- Keep the vehicle battery out of reach of children.

- See the Owner's Manual for further information.
- Explosive gas may be present in the vicinity of the vehicle battery.

Power saving mode

This mode deactivates electrical consumers to avoid excessive discharging of the vehicle battery. These consumers, such as the Infotainment system, windscreen wipers, low beam headlights, courtesy light, etc. can be used for a total maximum time of about 40 minutes after ignition is switched off.

Changing into power saving mode

When power saving mode is activated, a message appears in the Driver Information Centre.

An active telephone call using the hands-free option will be maintained for around 10 minutes longer.

Deactivating power saving mode

Power saving mode is deactivated automatically when the engine is restarted. Run the engine for a sufficient charge:

- for less than 10 minutes to use the consumers for approx. 5 minutes
- for more than 10 minutes to use the consumers for up to approx. 30 minutes

Heating functionalities**Notice**

Individual heating functionalities, such as heated seats or heated steering wheel, may be temporarily unavailable in the event of electrical loading constraints. Functions will be resumed after some minutes.

High voltage battery

To preserve the range and the durability of the high voltage battery, the following is recommended:

- Whenever possible do not charge the high voltage battery more than 80%.
- Do not completely discharge the high voltage battery.
- Do not store the vehicle for a long period of non-use (more than 12 hours) when the high voltage battery has a low or high charge level. Prefer a charge level between 20 and 40%.
- Limit the use of fast charging.
- Do not expose the vehicle to temperatures below -30 °C and above 60 °C for more than 24 hours.
- Avoid charging the vehicle at low temperatures (except if the vehicle ran more than 20 minutes) or above 30 °C.

- Do not use the high voltage battery as a generator of energy.
- Do not use a generator to recharge the high voltage battery.

Vehicle storage ⇨ 248.

Leakage

Damage to the high voltage battery could result in the leakage of toxic gases or fluids either immediately or later. The following is recommended:

- Always inform the fire and emergency services in the event of an incident, that the vehicle is equipped with a high voltage battery.
- Never touch the liquids leaking from the high voltage battery.
- Do not inhale the gases emitted by the high voltage battery which are toxic.

- Move away from the vehicle in the event of incident or accident, the gases emitted being flammable and could cause a fire.
- Too low a coolant level must be topped up and the cause of the coolant loss remedied by a workshop.

Diesel fuel system bleeding

If the tank has been run dry, the diesel fuel system must be bled. Refuel at least five litres diesel. Switch on the ignition for about 60 seconds and switch off again. Then crank the engine. If the engine does not start directly, repeat this process a few times. If the engine then fails to start, seek the assistance of a workshop.

Wiper blade replacement

Windscreen

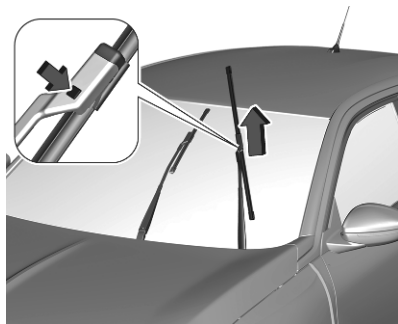

Switch off ignition.

Within one minute after switching off ignition, operate the wiper lever to position the wiper blades vertically on the windscreen.

Lift the wiper arm until it stays in the raised position, press button to disengage the wiper blade and remove.

Attach the new wiper blade to the wiper arm and push until it engages.

Lower wiper arm carefully.

To return the wiper arms to their original position, switch on the ignition and operate the wiper lever.

Rear window



Lift wiper arm. Disengage wiper blade as shown in illustration and remove.

Attach the wiper blade slightly angled to the wiper arm and push until it engages.

Lower wiper arm carefully.

Bulb replacement

Before replacing a bulb, ensure that all exterior and interior lights and the ignition are switched off.

Only hold a new bulb at the base. Do not touch the bulb glass with bare hands.

Use only the same bulb type for replacement.

Bulb check

After a bulb replacement switch on the ignition, operate and check the lights.

LED headlights

Headlights for low and high beam, daytime running lights and turn lights are designed as LEDs and cannot be changed.

Have lights repaired by a workshop in case of failure.

Front fog lights

Have lights repaired by a workshop in case of failure.

Tail lights

LED tail lights

Have lights repaired by a workshop in case of failure.

Rear fog light

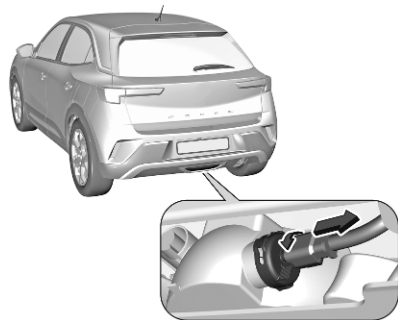

1. Turn the bulb holder anticlockwise and remove it from the reflector housing.

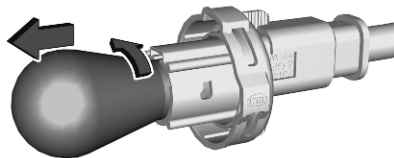

2. Slightly press down the bulb, turn it anticlockwise and remove it from the socket.
3. Replace and insert the new bulb into socket by turning clockwise.
4. Insert the bulb socket into the reflector and turn clockwise.

Centre high-mounted brake light

Have lights repaired by a workshop in case of failure.

Bulb check

Switch on the ignition, operate and check all lights.

Number plate light

Have lights repaired by a workshop in case of failure.

Interior lights

Have the following bulbs replaced by a workshop:

- courtesy light, reading lights
- load compartment light
- instrument panel illumination

Electrical system

Fuses

A defective fuse must be replaced by a workshop.

Vehicle tools

Tools

The vehicle tools are either located in a toolbag on the carpet, in a toolbox under the carpet or in a box below the floor cover in the load compartment.

Vehicles with spare wheel

Open the load compartment.

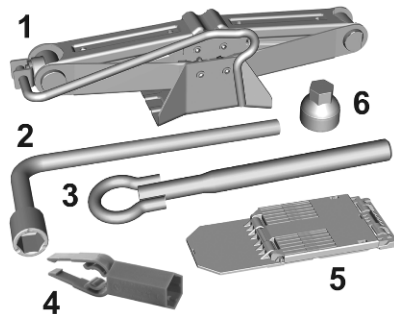

The tools are located either in the toolbox on the carpet or in the toolbox under the carpet:

- Jack (1)
- Wheel wrench (2)

- Towing eye (3)
- Wheel bolt cover remover (4)
- Chock (5)
- Adapter for the locking wheel nuts (6)

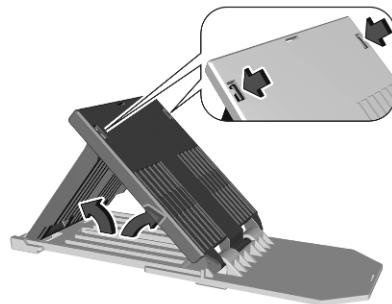

To use the chock, fold apart and stick together.

Vehicles without spare wheel

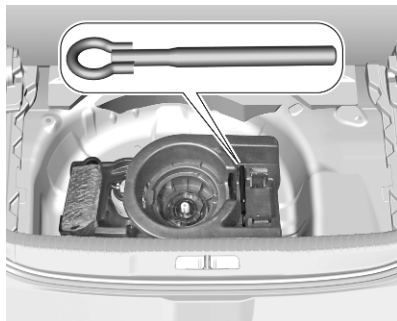

The towing eye is located in a box below the floor cover in the load compartment.

Tyre repair kit ⇨ 265.

Wheels and tyres

Tyre condition, wheel condition

Drive over edges slowly and at right angles if possible. Driving over sharp edges can cause tyre and wheel damage. Do not trap tyres on the kerb when parking.

Regularly check the wheels for damage. Seek the assistance of a workshop in the event of damage or unusual wear.

Winter tyres

Winter tyres improve driving safety at temperatures below 7 °C and should therefore be fitted on all wheels.

In accordance with country-specific regulations, affix the speed sticker in the driver's field of view, if the tyre speed code is below the maximum speed of the vehicle.

All tyre sizes are permitted as winter tyres ⇨ 291.

Tyre designations

E.g. **225/55 R 18 98 V**

225 : tyre width, mm

55 : cross-section ratio (tyre height to tyre width), %

R : belt type: Radial

RF : type: RunFlat

18 : wheel diameter, inches

98 : load index e.g. 98 is equivalent to 750 kg

V : speed code letter

Speed code letter:

Q : up to 100 mph

S : up to 112 mph

T : up to 118 mph

H : up to 130 mph

V : up to 150 mph

W : up to 168 mph

Choose a tyre appropriate for the maximum speed of your vehicle.

The maximum speed is achievable at kerb weight with driver (75 kg) plus 125 kg payload. Optional equipment could reduce the maximum speed of the vehicle.

Directional tyres

Directional tyres should be mounted so that they rotate in the correct direction. The proper rotation direction is indicated by a symbol (e.g. an arrow) on the sidewall.

Tyre pressure

Check the pressure of cold tyres at least every 14 days and before any long journey. Do not forget the spare wheel. This also applies to vehicles with tyre deflation detection system.

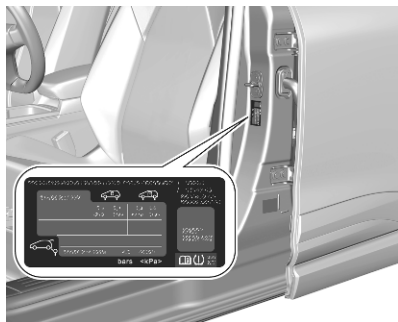

The tyre pressure information label on the left B-pillar indicates the original equipment tyres and the correspondent tyre pressures.

The tyre pressure data refers to cold tyres. It applies to summer and winter tyres.

Always inflate the spare tyre to the pressure specified for full load.

Incorrect tyre pressures will impair safety, vehicle handling, comfort and fuel economy and will increase tyre wear.

The driver is responsible for correct adjustment of tyre pressure.

The tyre pressure tables show all possible tyre combinations ↻ 291.

For the tyres approved for your vehicle, refer to the EEC Certificate of Conformity provided with your vehicle or other national registration documents.

Tyre pressures differ depending on various options. For the correct tyre pressure value, identify the respective tyre in the tyre pressure table ↻ 291 or on the tyre pressure information label as described before.

⚠ Warning

If the pressure is too low, this can result in considerable tyre warm-up and internal damage, leading to tread separation and even to tyre blow-out at high speeds.

⚠ Warning

For specific tyres the recommended tyre pressure as shown in the tyre pressure table may exceed the maximum tyre pressure as indicated on the tyre. Never exceed the maximum tyre pressure as indicated on the tyre.

Temperature dependency

The tyre pressure depends on the temperature of the tyre. During driving, tyre temperature and pressure increase. Tyre pressure values provided on the tyre information label and tyre pressure chart are valid for cold tyres, which means at 20 °C.

The pressure increases by nearly 1.5 psi for a 10 °C temperature increase. This must be considered when warm tyres are checked.

Tyre deflation detection system

The tyre deflation detection system continually checks the rotation speed of all four wheels and warns on low tyre pressure condition once vehicle is driving. This is achieved by comparing tyre rolling circumference with reference values and further signals.

If a tyre loses pressure the control indicator  illuminates and a warning message is displayed in the Driver Information Centre.

Control indicator  ⇨ 74.

In this case reduce speed, avoid sharp cornering and strong braking. Stop at next safe opportunity and check tyre pressure.

After adjusting tyre pressure initialise system to extinguish the control indicator and restart system.

If the failure continues to be displayed, contact a workshop. The system is inoperable when the ABS or Electronic Stability Control has a malfunction or a temporary spare wheel is used. Once the tyre has been refitted, check the tyre pressure with cold tyres and initialise the system.

Caution

Deflation detection system warns just about low tyre pressure condition and does not replace regular tyre maintenance by the driver.

System initialisation

After tyre pressure correction or wheel change, the system must be initialised to learn new circumference reference values:

1. Always ensure that all four tyres have correct tyre pressure ⇨ 291.
2. Apply parking brake.

3. Initialise the system via the Info Display ⇨ 78.
4. Reset is confirmed by pop-up indication.

After initialisation system automatically calibrates to new tyre pressures during driving. After longer drive the system will adopt and monitor new pressures.

Always check tyre pressure with cold tyres.

System has to be reinitialised when:

- Tyre pressure has been changed
- Load condition has been changed
- Wheels have been swapped or exchanged

The system will not warn instantaneously on a tyre blow out or a rapid deflation. This is due to required calculation time.

Tread depth

Check tread depth at regular intervals.

For safety reasons, it is recommended that the tread depth of the tyres on one axle should not vary by more than 2 mm.



The legally permissible minimum tread depth (1.6 mm) has been reached when the tread has worn down as far as one of the tread wear indicators (TWI). Their position is indicated by markings on the sidewall.

If there is more wear at the front than the rear, swap round front wheels and rear wheels periodically. Ensure that the direction of rotation of the wheels remains the same.

Tyres age, even if they are not used. We recommend tyre replacement every 6 years.

Changing tyre and wheel size

If tyres of a different size than those fitted at the factory are used, it may be necessary to reprogramme the tyre deflation detection system and make other vehicle modifications.

Have the label with tyre pressures replaced.

⚠ Warning

The use of unsuitable tyres or wheels may lead to accidents and will invalidate the vehicle operating permit.

Wheel covers

Wheel covers and tyres that are factory approved for the respective vehicle and comply with all of the relevant wheel and tyre combination requirements must be used.

If the wheel covers and tyres used are not factory approved, the tyres must not have a rim protection ridge.

Wheel covers must not impair brake cooling.

⚠ Warning

Use of unsuitable tyres or wheel covers could lead to sudden pressure loss and thereby accidents.

Vehicles with steel wheels: When using locking wheel nuts, do not attach wheel covers.

Spare wheels: Do not use wheel covers.

Tyre chains

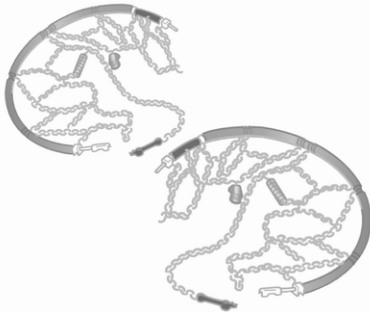

Tyre chains are only permitted on the front wheels.

Only use tyre chains designed to be used with tyre type of the vehicle:

- For 16 inch and 17 inch tyres, only use Polaire XP9 120 (9mm) tyre chains.
- For 18 inch tyres, only use Polaire 0112 PSSD tyre chains.

Notice

The use of tyre chains and the maximum allowed speed is regulated by country-specific legislation.

⚠ Warning

Damage may lead to tyre blowout.

When fitting the tyre chains follow the instructions provided by the manufacturer of the tyre chains.

After having fitted the tyre chains, stop the vehicle after having driven a short distance and make sure that the tyre chains are correctly tightened.

Temporary spare wheel

The use of tyre chains is not permitted on the temporary spare wheel.

Tyre repair kit

Minor damage to the tyre tread can be repaired with the tyre repair kit.

Do not remove foreign bodies from the tyres.

Tyre damage exceeding 4 mm or that is at tyre's sidewall cannot be repaired with the tyre repair kit.

Depending on version, there are two different tyre repair kits (Type A and Type B).

⚠ Warning

Do not drive faster than 50 mph.
Do not use for a lengthy period.
Steering and handling may be affected.

In the case of a flat tyre:

Apply the parking brake and engage first gear, reverse gear or **P**.

The tyre repair kit is in the load compartment below the floor cover.

1. Remove the sealant bottle and the compressor.
2. Pull speed limit label from sealant bottle and place it in driver's visible area.

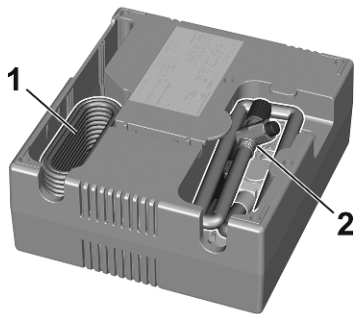

3. Remove the electrical connection cable (1) and air hose (2) from the stowage compartments on the underside of the compressor.

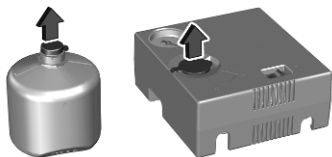

4. Type A: Open sealant bottle and lift the lid.

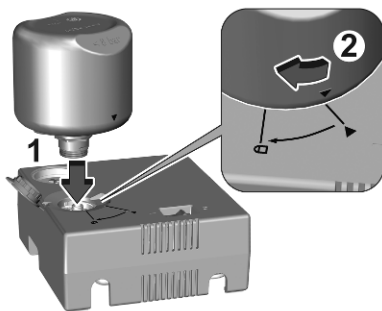

5. Type A: First, insert sealant bottle into the compressor and align the triangle symbols. Then, push down sealant bottle and turn it to the lock position.

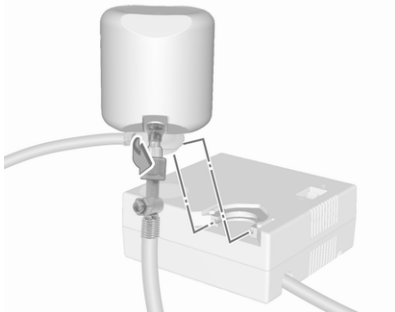

Type B: Screw the compressor air hose to the connection on the sealant bottle.

6. Type B: Fit the sealant bottle into the bracket on the compressor.
 7. Set the compressor near the tyre in such a way that the sealant bottle is upright.
 8. Unscrew valve cap from defective tyre.

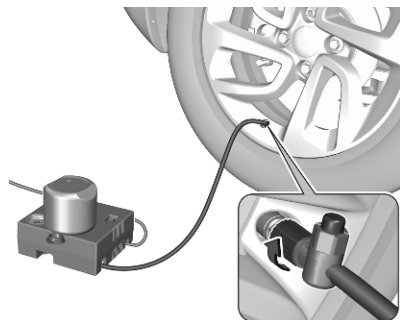

9. Screw the filler hose to the tyre valve.
 10. The switch on the compressor must be set to O.

11. Connect the compressor plug to the 12 V power outlet or cigarette lighter socket ↪ 61.

To avoid discharging the vehicle battery, we recommend to use the tyre repair kit only when the combustion engine is running or when the electric engine is ready.

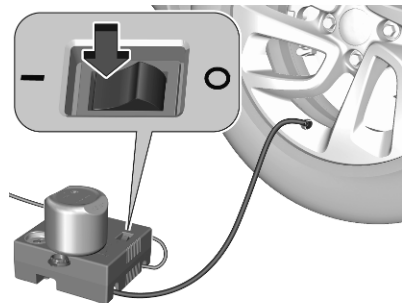

12. Set the rocker switch on the compressor to I. The tyre is filled with sealant.
13. The compressor pressure gauge briefly indicates up to 600 kPa (6 bar) whilst the sealant bottle is emptying (approx. 30 seconds). Then the pressure starts to drop.

14. All of the sealant is pumped into the tyre. Then the tyre is being inflated.

15. The prescribed tyre pressure should be obtained within ten minutes.

Tyre pressure ↪ 291.

When the correct pressure is obtained, switch off the compressor.

If the prescribed tyre pressure is not obtained within ten minutes, remove the tyre repair kit. Move the vehicle one tyre rotation. Reattach the tyre repair kit and continue the filling procedure for 10 minutes. If the prescribed tyre pressure is still not obtained, the tyre is too badly damaged. Seek the assistance of a workshop.

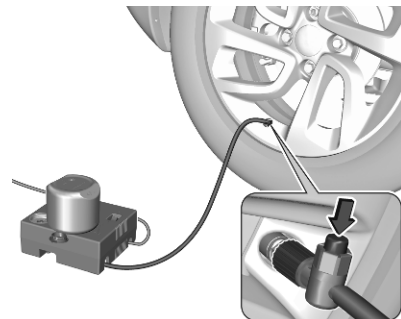

Drain excess tyre pressure with the button on the air hose.

Do not run the compressor longer than ten minutes.

16. Detach the tyre repair kit. Remove sealant bottle from compressor. Screw the filler hose to the free connection of the sealant bottle. This prevents sealant from escaping. Stow tyre repair kit in load compartment.
17. Remove any excess sealant using a cloth.
18. Continue driving immediately so that sealant is evenly distributed in the tyre. Drive between 13 mph and 37 mph. After driving

approx. 3 miles but no more than ten minutes, stop and check tyre pressure. Screw compressor air hose directly onto tyre valve when doing this. Fill tyre as described before. Drain excess tyre pressure with the button on the air hose.

If tyre pressure hasn't decreased under 200 kPa (2 bar), set it to the correct value. Otherwise the vehicle must not be used. Seek assistance of a workshop.

Repeat the checking procedure once more after driving further 3 miles but no more than ten minutes to check that there is no more loss of pressure.

If the tyre pressure has fallen below 200 kPa (2 bar), the vehicle must not be used. Seek the assistance of a workshop.

19. Stow away tyre repair kit in load compartment.

Notice

The driving characteristics of the repaired tyre are severely affected, therefore have this tyre replaced.

If unusual noise is heard or the compressor becomes hot, turn compressor off for at least 30 min.

The built-in safety valve opens at a pressure of seven bar (102 psi).

Note the expiry date of the kit. After this date its sealing capability is no longer guaranteed. Pay attention to storage information on sealant bottle.

Replace the used sealant bottle. Dispose of the bottle as prescribed by applicable laws.

The compressor and sealant can be used from approx. -30 °C.

Wheel changing

Make the following preparations and observe the following information:

- Park the vehicle on a level, firm and non-skid surface. The front wheels must be in the straight-ahead position.
- Apply the parking brake and engage first gear, reverse gear or P.

- Place a chock under the wheel diagonally opposite the wheel to be changed.
- If the ground on which the vehicle is standing is soft, a solid board (approx. 1 cm thick) should be placed under the jack.
- Take heavy objects out of the vehicle before jacking up.
- No people or animals may be in the vehicle when it is jacked-up.
- Never crawl under a jacked-up vehicle.
- Do not start the vehicle when it is raised on the jack.
- Before screwing in the wheel bolts, clean them.

Warning

Do not grease wheel bolts.

Tightening torques

⚠ Warning

Ensure to use always the correct wheel bolts if changing the wheels. When installing the spare wheel for temporary usage, the bolts for alloy wheel rims can also be used.

Depending on the wheel rim material, two different bolts are available.

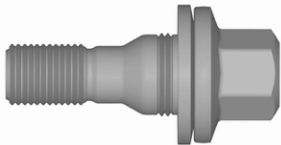

Tightening torque for alloy wheel rims is 115 Nm.

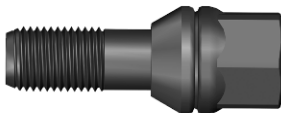

Tightening torque for steel wheel rims is 115 Nm.

Use the correct wheel bolts for the respective wheels.

Jacking positions

The jacking positions shown refer to the use of lifting arms and accessory jacks used for changing winter / summer tyres.



The rear arm position of the lifting platform is centrally under the relevant vehicle jacking point.

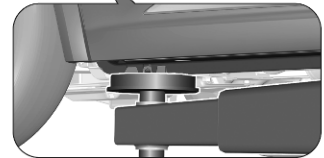

The front arm position of the lifting platform is centrally under the relevant vehicle jacking point.

Spare wheel

The spare wheel can be classified as a temporary spare wheel depending on the size compared to the other mounted wheels and country regulations. In this case, a permissible maximum speed applies, even though no label at the spare wheel indicates this.

If there is a label on the spare wheel, the permissible speed still depends on the country regulations.

Only mount one temporary spare wheel. Take curves slowly. Do not use for a long period of time.

Caution

The use of a spare wheel that is smaller than the other wheels or in combination with winter tyres could affect driveability. Have the defective tyre replaced as soon as possible.

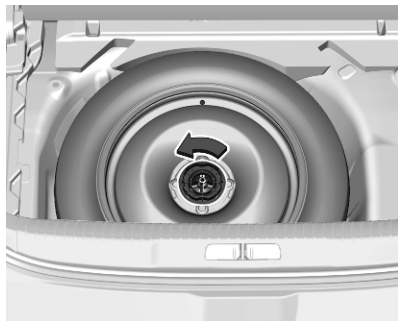

The spare wheel is located in the load compartment beneath the floor covering.

To remove:

1. Open the floor cover ⇨ 49.
2. The temporary spare wheel is secured with a wing nut. Unscrew nut and take out the spare wheel.
3. When, after a wheel change, no wheel is placed in the spare wheel well, tighten the wing nut and close floor cover.
4. After wheel change back to full size wheel, place the temporary spare wheel in the well and secure with the wing nut.

Only mount one temporary spare wheel. The permissible maximum speed on the label on the temporary spare wheel is only valid for the factory-fitted tyre size.

Fitting the spare wheel

Make the following preparations and observe the following information:

- Park the vehicle on a level, firm and non-skid surface. The front wheels must be in the straight-ahead position.

- Apply the parking brake and engage first gear, reverse gear or P.
- Place a chock under the wheel diagonally opposite the wheel to be changed.
- Remove the spare wheel.
- Never change more than one wheel at once.
- Use the jack only to change wheels in case of puncture, not for seasonal winter or summer tyre change.
- The jack is maintenance-free.
- If the ground on which the vehicle is standing is soft, a solid board (approx. 1 cm thick) should be placed under the jack.
- Take heavy objects out of the vehicle before jacking up.
- No people or animals may be in the vehicle when it is jacked-up.
- Never crawl under a jacked-up vehicle.
- Do not start the vehicle when it is raised on the jack.

- Before screwing in the wheel bolts, clean them.

⚠ Warning

Do not grease wheel bolts.

⚠ Warning

Ensure to use always the correct wheel bolts if changing the wheels. When installing the spare wheel for temporary usage, the bolts for alloy wheel rims can also be used.

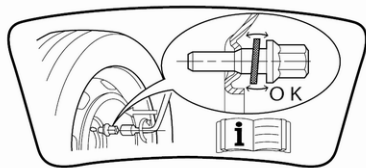

- Note that the spare wheel is secured by the conical contact of each bolt if the wheel bolts for the alloy wheel rims are used. In this case, the washers do not come into contact with the spare wheel.

1. Disengage wheel bolt caps with the wheel bolt cover remover.

Vehicle tools ⇨ 260.

Steel wheel rims with cover: Pull off the wheel cover.



2. Attach the wheel wrench and loosen each wheel bolt by half a turn.

The wheels might be protected by locking wheel nuts. To loosen

these specific nuts first attach the adapter onto the head of the nut before installing the wheel wrench. The adapter is located in the tool bag.

The wheels might be protected by locking wheel nuts. To loosen these specific nuts first attach the adapter onto the head of the nut before installing the wheel wrench. The adapter is located in the tool bag ⇨ 260.



3. Ensure the jack is correctly positioned under the relevant vehicle jacking point.

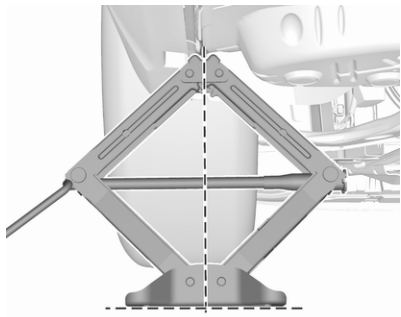

4. Set the jack to the necessary height. Position it directly below the jacking point in a manner that prevents it from slipping.

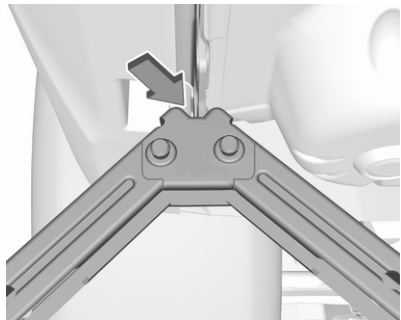

Ensure that the edge of the body fits into the notch of the jack.

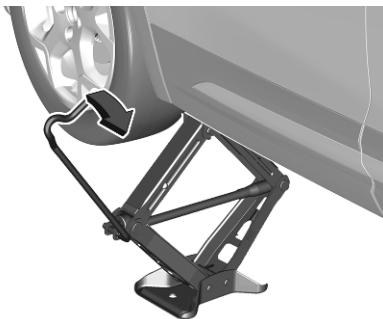

With the jack correctly aligned, jack up until wheel is clear of the ground.

5. Unscrew the wheel nuts.
6. Change the wheel.
7. Screw on the wheel nuts.
8. Lower the vehicle and remove jack.
9. Install the wheel wrench ensuring that it is located securely and tighten each bolt in a crosswise sequence.

Tightening torque is 115 Nm.

If the vehicle is equipped with alloy wheel rims, note that the wheel bolts can also be used for the spare wheel with steel rims. In this case, the spare wheel is secured by the conical contact of each bolt.

10. Stow the replaced wheel, the vehicle tools and the adapter for the locking wheel nuts ↻ 260.
11. Check the tyre pressure of the installed tyre and the wheel nut torque as soon as possible.

Stowing a damaged full size wheel in the load compartment

The spare wheel well is not designed for other tyre sizes than the spare wheel. A damaged full size wheel must be stowed in the load compartment and secured properly. Loading information ↻ 51.

Jump starting

Do not start with quick charger.

A vehicle with a discharged vehicle battery can be started using jump leads and the vehicle battery of another vehicle.

Caution

Never jump start another vehicle with an electric vehicle.

⚠ Warning

Be extremely careful when starting with jump leads. Any deviation from the following instructions can lead to injuries or damage caused by battery explosion or damage to the electrical systems of both vehicles.

⚠ Warning

Avoid contact of the battery with eyes, skin, fabrics and painted surfaces. The fluid contains sulphuric acid which can cause injuries and damage in the event of direct contact.

- Never expose the vehicle battery to naked flames or sparks.
- A discharged vehicle battery can already freeze at a temperature of 0 °C. Defrost the frozen battery before connecting jump leads.
- Wear eye protection and protective clothing when handling a battery.
- Use a booster battery with the same voltage (12 V). Its capacity (Ah) must not be much less than that of the discharged vehicle battery.
- Use jump leads with insulated terminals and a cross section of at least 16 mm² (25 mm² for diesel engines).

- Do not disconnect the discharged vehicle battery from the vehicle.
- Switch off all unnecessary electrical consumers.
- Do not lean over the vehicle battery during jump starting.
- Do not allow the terminals of one lead to touch those of the other lead.
- The vehicles must not come into contact with each other during the jump starting process.
- Apply the parking brake, transmission in neutral, automatic transmission in P.

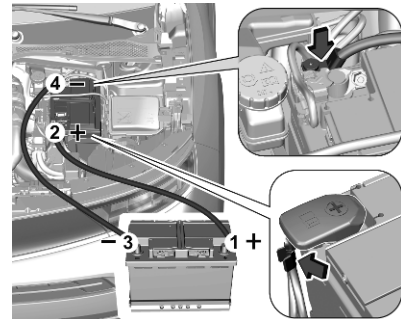

Lead connection order:

1. Connect the red lead to the positive terminal of the booster battery.
2. Connect the other end of the red lead to the positive terminal of the discharged battery.
3. Connect the black lead to the negative terminal of the booster battery.
4. Connect the other end of the black lead to a vehicle grounding point of your vehicle in the engine compartment.

Route the leads so that they cannot catch on rotating parts in the engine compartment.

To start the engine:

1. Start the engine of the vehicle providing the jump.
2. After 5 minutes, start the other engine. Start attempts should be made for no longer than 15 seconds at an interval of 1 minute.

3. Allow both engines to idle for approx. 3 minutes with the leads connected.
4. Switch on electrical consumers e.g. headlights, heated rear window.
5. Reverse above sequence exactly when removing leads.

Towing

Towing the vehicle

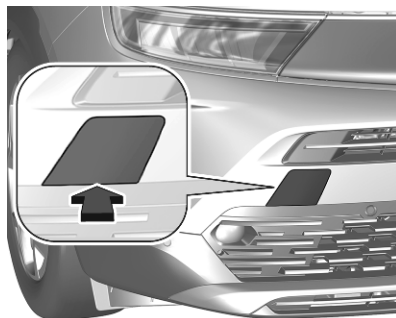

Remove the cap.

The towing eye is stowed with the vehicle tools ⇨ 260.

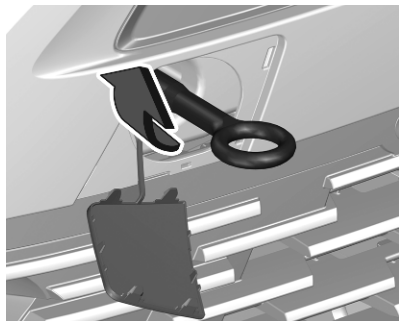

Screw in the towing eye as far as it will go until it stops in a horizontal position.

Attach the tow rod to the towing eye.

The towing eye must only be used for towing and not for recovering the vehicle.

Switch on ignition to permit operation of brake lights, horn, windscreen wiper and, depending on version, to release the steering wheel lock.

Caution

Deactivate the driver assistance systems like active emergency braking ⇨ 200, otherwise the vehicle may automatically brake during towing.

Switch the selector lever to neutral.
Release the parking brake.

Caution

Drive slowly. Do not drive jerkily. Excessive tractive force can damage the vehicle.

When the engine is not running, considerably more force is needed to brake and steer.

To prevent the entry of exhaust gases from the towing vehicle, switch on the air recirculation and close the windows.

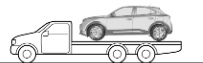

When towing a BEV or a vehicle equipped with an automatic transmission, transport the vehicle on a platform or tow it with the front wheels lifted.

Seek the assistance of a workshop.

After towing, unscrew the towing eye.

Insert cap with the flange into the recess and fix cap by pushing.

Propulsion types ⇨ 4.

Towing another vehicle

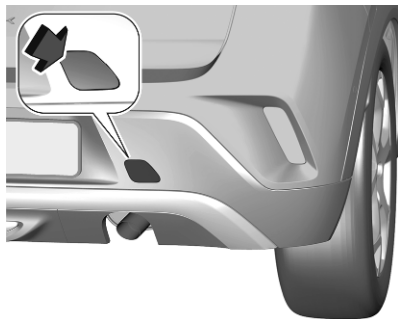

Remove the cap.

The towing eye is stowed with the vehicle tools ↗ 260.



Screw in the towing eye as far as it will go until it stops in a horizontal position.

Attach a tow rope – or better still a tow rod – to the towing eye.

The towing eye must only be used for towing and not for recovering a vehicle.

Caution

Drive slowly. Do not drive jerkily. Excessive tractive force can damage the vehicle.

After towing, unscrew the towing eye.

Insert cap with the upper flange into the recess and fix cap by pushing.

Appearance care

Exterior care

Locks

The locks are lubricated at the factory using a high quality lock cylinder grease. Use a de-icing agent only when absolutely necessary, as this has a degreasing effect and impairs lock function. After using a de-icing agent, have the locks regreased by a workshop.

Washing

The paintwork of your vehicle is exposed to environmental influences. Bird droppings, dead insects, resin, pollen and the like should be cleaned off immediately, as they contain aggressive constituents which can cause paint damage.

If using a vehicle wash, comply with the vehicle wash manufacturer's instructions. The windscreen wiper and rear window wiper must be

switched off. Remove antenna and external accessories such as roof racks etc.

If you wash your vehicle by hand, make sure that the insides of the wheel housings are also thoroughly rinsed out.

Clean edges and folds on opened doors and the bonnet as well as the areas they cover.

Clean bright metal mouldings with a cleaning solution approved for aluminium to avoid damages.

Caution

Always use a cleaning agent with a pH value of 4 to 9.

Do not use cleaning agents on hot surfaces.

Do not clean the engine compartment with a steam-jet or high-pressure jet cleaner.

Thoroughly rinse and leather-off the vehicle. Rinse leather frequently. Use separate leathers for painted and glass surfaces: remnants of wax on the windows will impair vision.

Have the door hinges of all doors greased by a workshop.

Exterior lights

Headlight and other light covers are made of plastic. Do not use any abrasive or caustic agents, do not use an ice scraper, and do not clean them dry.

Polishing and waxing

Polishing is necessary only if the paint has become dull or if solid deposits have become attached to it.

Plastic body parts must not be treated with wax or polishing agents.

Windows and wiper blades

Switch off wipers before handling in their areas.

Use a soft lint-free cloth or chamois leather together with window cleaner and insect remover.

When cleaning the rear window from inside, always wipe in parallel to the heating element to prevent damage.

For mechanical removal of ice, use a sharp-edged ice scraper. Press the scraper firmly against the glass so that no dirt can get under it and scratch the glass.

Clean smearing wiper blades with a soft cloth and window cleaner. Also make sure to remove any residues such as wax, insect residues and similar from the window.

Ice residues, pollution and continuous wiping on dry windows will damage or even destroy the wiper blades.

Wheels and tyres

Do not use high-pressure jet cleaners.

Clean rims with a pH-neutral wheel cleaner.

Rims are painted and can be treated with the same agents as the body.

Paintwork damage

Rectify minor paintwork damage with a touch-up pen before rust forms. Have more extensive damage or rust areas repaired by a workshop.

Underbody

Some areas of the vehicle underbody have a PVC undercoating while other critical areas have a durable protective wax coating.

After the underbody is washed, check the underbody and have it waxed if necessary.

Bitumen / rubber materials could damage the PVC coating. Have underbody work carried out by a workshop.

Before and after winter, wash the underbody and have the protective wax coating checked.

Towing equipment

Do not clean the coupling ball bar with a steam-jet or high-pressure jet cleaner.

Interior care

Interior and upholstery

Only clean the vehicle interior, including the instrument panel fascia and panelling, with a dry cloth or interior cleaner.

Clean the leather upholstery with clear water and a soft cloth. In case of heavy soiling, use leather care.

The Driver Information Centre and the displays should only be cleaned using a soft damp cloth. If necessary use a weak soap solution.

Clean fabric upholstery with a vacuum cleaner and brush. Remove stains with an upholstery cleaner.

Clothing fabrics may not be colourfast. This could cause visible discolourations, especially on light-coloured upholstery. Removable stains and discolourations should be cleaned as soon as possible.

Clean seat belts with lukewarm water or interior cleaner.

Caution

Close Velcro fasteners as open Velcro fasteners on clothing could damage seat upholstery.

The same applies to clothing with sharp-edged objects, like zips or belts or studded jeans.

Plastic and rubber parts

Plastic and rubber parts can be cleaned with the same cleaner as used to clean the body. Use interior cleaner if necessary. Do not use any other agent. Avoid solvents and petrol in particular. Do not use high-pressure jet cleaners.

Floor mats

Warning

If a floor mat has the wrong size or is not properly installed, it can interfere with the accelerator pedal and/or brake pedal, what can cause unintended acceleration

and/or increased stopping distance which can cause a crash and injury.

Use the following guidelines for proper floor mat usage.

- The original equipment floor mats were designed for this vehicle. If the floor mats need to be replaced, it is recommended to buy certified floor mats which fit properly and are fixed by the retainers on the driver side. Always check that the floor mats do not interfere with the pedals.
- Use the floor mat with the correct side up. Do not turn it over.
- Do not place anything on top of the driver side floor mat.
- Use only a single floor mat on the driver side.

Inserting floor mats

The driver side floor mat is held in place by two retainers.

To install:

1. Move the seat backwards as far as possible.

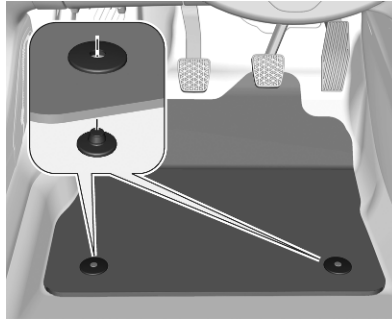

2. Align slots in the mat with the retainers, as shown.
3. Push the mat to the floor.

Removing floor mats

To remove:

1. Move the seat backwards as far as possible.
2. Remove the mat.

Service and maintenance

General information	280
Service information	280
Recommended fluids, lubricants and parts	283
Recommended fluids and lubricants	283

General information

Service information

In order to ensure economical and safe vehicle operation and to maintain the value of your vehicle, it is of vital importance that all maintenance work is carried out at the proper intervals as specified.

The detailed, up-to-date service schedule for your vehicle is available at the workshop.

Severe operating conditions exist if one or more of the following circumstances occur frequently: Cold starting, stop and go operation, e.g. for taxis and police vehicles, trailer operation, mountain driving, driving on poor and sandy road surfaces, increased air pollution, presence of airborne sand and high dust content, driving at high altitude and large variations of temperature.

Under these severe operating conditions, certain service work may be required more frequently than the regular service interval indicated in

the service display. Contact a workshop for customised service schedules.

Service display ⇨ 66.

Service intervals

Engine code	EB2LTD, EB2LTED	EB2ADTD, EB2ADTS, EB2ADTSM	DV5RCE	Electric vehicle
Country group 1	16,000 miles / 1 year	12,500 miles / 1 year	20,000 miles / 1 year ¹⁾	16,000 miles / 2 years ²⁾

1) Unless otherwise indicated in the service display.

2) Initial service interval is 8,000 miles / 1 year

Country Group 1:

Andorra, Austria, Belgium, Cyprus, Denmark, Finland, France, Germany, Greece, Iceland, Italy, Liechtenstein, Luxembourg, Malta, Monaco, Netherlands, Norway, Portugal, Republic of Ireland, San Marino, Spain, Sweden, Switzerland, United Kingdom.

Country Group 2:

Bosnia-Herzegovina, Bulgaria, Croatia, Czech Republic, Estonia, Hungary, Latvia, Lithuania, North Macedonia, Poland, Romania, Slovakia, Slovenia.

Country Group 3:

Albania, Kosovo, Montenegro, New Zealand, Serbia.

Country Group 4:

Israel, Lesotho, South Africa, Swaziland, Turkey.

Country Group 5:

Russia.

Country Group 6:

All other countries which are not listed in the previous country groups.

Confirmations

Confirmation of service is recorded in the Service and warranty booklet. The date and mileage is completed with the stamp and signature of the servicing workshop.

Make sure that the Service and warranty booklet is completed correctly as continuous proof of service is essential if any warranty or goodwill claims are to be met, and is also a benefit when selling the vehicle.

Recommended fluids, lubricants and parts

Recommended fluids and lubricants

Only use products that meet the recommended specifications.

Warning

Operating materials are hazardous and could be poisonous. Handle with care. Pay attention to information given on the containers.

Engine oil

Engine oil is identified by its quality and its viscosity. Quality is more important than viscosity when selecting which engine oil to use. The oil quality ensures e.g. engine cleanliness, wear protection and oil aging control, whereas viscosity grade gives information on the oil's thickness over a temperature range.

Select the appropriate engine oil based on its quality and on the minimum ambient temperature ⇨ 287.

Topping up engine oil

Caution

In case of any spilled oil, wipe it up and dispose it properly.

Engine oils of different manufacturers and brands can be mixed as long as they comply with the required engine oil quality and viscosity.

Use of engine oils for all petrol engines with only ACEA quality is prohibited, since it can cause engine damage under certain operating conditions.

Select the appropriate engine oil based on its quality and on the minimum ambient temperature ⇨ 287.

Additional engine oil additives

The use of additional engine oil additives could cause damage and invalidate the warranty.

Engine oil viscosity grades

The SAE viscosity grade gives information of the thickness of the oil.

Multigrade oil is indicated by two figures, e.g. SAE 5W-30. The first figure, followed by a W, indicates the low temperature viscosity and the second figure the high temperature viscosity.

Select the appropriate viscosity grade depending on the minimum ambient temperature ⇨ 287.

All of the recommended viscosity grades are suitable for high ambient temperatures.

Coolant and antifreeze

Use only antifreeze approved for the vehicle. Consult a workshop.

The system is factory filled with coolant designed for excellent corrosion protection and frost protection down to approx. -28 °C. In cold regions with very low temperatures the factory filled coolant provides frost protection down to approx. -37 °C. This concentration should be maintained all year round.

The use of additional coolant additives that intend to give additional corrosion protection or seal against minor leaks can cause function problems. Liability for consequences resulting from the use of additional coolant additives will be rejected.

Washer fluid

Use only washer fluid approved for the vehicle to prevent damage of wiper blades, paintwork, plastic and rubber parts. Consult a workshop.

Brake and clutch fluid

Over time, brake fluid absorbs moisture which will reduce braking effectiveness. The brake fluid should therefore be replaced at the specified interval.

Use only brake fluid approved for the vehicle. Consult a workshop.

AdBlue

Only use AdBlue to reduce the nitrogen oxides in the exhaust emission ↗ 172.

Technical data

Vehicle identification	285
Vehicle identification number ..	285
Identification plate	285
Engine identification	286
Vehicle data	287
Recommended fluids and lubricants	287
Engine data	288
Vehicle dimensions	289
Capacities	290
Tyre pressures	291

Vehicle identification

Vehicle identification number

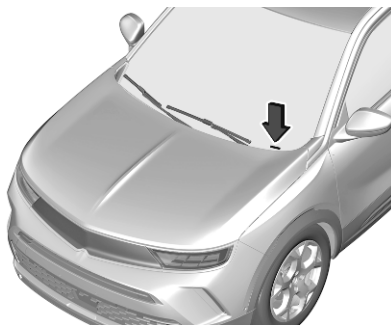

The Vehicle Identification Number may be embossed on the instrument panel, visible through the windscreen, or in the engine compartment on the right body panel.

Identification plate

The identification plate is located on the front left or right door frame. The layout and position differ for some export countries.

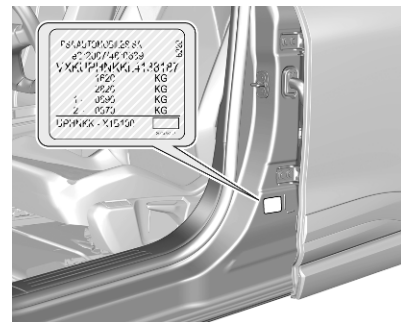

Information on identification label:

- 1 : manufacturer
- 2 : type approval number
- 3 : vehicle identification number
- 4 : permissible gross vehicle weight rating in kg
- 5 : permissible gross train weight in kg
- 6 : maximum permissible front axle load in kg
- 7 : maximum permissible rear axle load in kg
- 8 : manufacturer address, vehicle-specific or country-specific data

The combined total of front and rear axle loads must not exceed the permissible gross vehicle weight.

Vehicle's kerb weight depends on the specification of the vehicle, e.g. optional equipment and accessories. Refer to the EEC Certificate of Conformity provided with your vehicle or other national registration documents.

The technical data is determined in accordance with European Community standards. We reserve the right to make modifications. Specifications in the vehicle documents always have priority over those given in this manual.

Engine identification

The technical data tables show the engine identifier code.

Engine data ⇨ 288.

To identify the respective engine, refer to the engine power in the EEC Certificate of Conformity provided with your vehicle or other national registration documents.

Vehicle data

Recommended fluids and lubricants

Required engine oil quality

Country groups ⇨ 280

Countries included in country groups 1 to 3 and 5

all engines

Vauxhall Original engine oil

B71 2010 / B71 2312

Engine EC5F: B71 2290, B71 2296 or B71 300 may also be used.

Engine oil viscosity grades

	B71 2010	B71 2312	B71 2302	B71 2297
Engine oil viscosity grade	SAE 0W-20	SAE 0W-30	SAE 0W-30	SAE 5W-30

Engine data

Engine identifier code	EB2LTD	EB2LTED	EB2ADTD	EB2ADTS	EB2ADTSM	DV5RCE	Electric vehicle
Sales designation	1.2 T	1.2 T	1.2 T	1.2 T	1.2 T	1.5 D	–
Piston displacement [cm ³]	1199	1199	1199	1199	1199	1499	–
Engine power [kW]	100	74 / 81	74	96	96	81	100 / 115
at rpm	6000	6000	5500	5500	5500	3750	–
Torque [Nm]	230	205	205	230	230	250	260
at rpm	1750	1750	1750	1750	1750	1750	–
Fuel type	Petrol	Petrol	Petrol	Petrol	Petrol	Diesel	–
Octane rating RON ¹⁾²⁾							
recommended	95	95	95	95	95	–	–
possible	98	98	98	98	98	–	–
possible	91	91	91	91	91	–	–
Additional fuel type	–	–	–	–	–	–	–

1) A country specific label at the fuel filler flap can supersede the engine specific requirement.

2) In certain countries, the use of a particular fuel, e.g. a specific octane rating, may be required to ensure proper engine operation.

Vehicle dimensions

Length [mm]	4151
Width with two exterior mirrors folded [mm]	1791
Width with two exterior mirrors [mm]	1987
Height (without antenna) [mm]	1531 / 1532 ³⁾
Length of load compartment floor [mm]	667
Length of load compartment with folded second row [mm]	1418
Load compartment width between wheel arches [mm]	1021
Wheelbase [mm]	2557 / 2561 ³⁾
Turning circle diameter [m]	11.08

3) electric vehicle

Capacities

Engine oil

Engine	EB2LTD, EB2LTED	EB2ADTD	EB2ADTS	EB2ADTSM	DV5RCE
including filter [l]	- ⁴⁾	3.5	3.5	3.5	4.0
between MIN and MAX [l]	-	1.0	1.0	1.0	1.5

4) Not available at time of printing.

Fuel tank

Petrol, refilling quantity [l]	44
Diesel, refilling quantity [l]	41

AdBlue tank

AdBlue, refilling quantity [l]	13
--------------------------------	----

High voltage battery

Battery capacity [kWh]	50
------------------------	----

Tyre pressures

Engine	Tyres	Vehicle with up to 3 people		With full load	
		front [kPa/bar] ([psi])	rear [kPa/bar] ([psi])	front [kPa/bar] ([psi])	rear [kPa/bar] ([psi])
ICE	215/65 R16, 215/60 R17, 215/55 R18	220/2.2 (32)	220/2.2 (32)	270/2.7 (39)	270/2.7 (39)
BEV	215/65 R16, 215/60 R17, 215/55 R18	250/2.5 (36)	250/2.5 (36)	250/2.5 (36)	300/3.0 (44)
	125/85 R16 Temporary spare wheel	420/4.2 (60)	420/4.2 (60)	420/4.2 (60)	420/4.2 (60)

Propulsion types ⇨ 4.

Customer information

Customer information	292
Declaration of conformity	292
REACH	294
Software update	294
Registered trademarks	295
Vehicle data recording and privacy	296
Emergency call data recording and privacy	296
Event data recorders	297
Radio Frequency Identification (RFID)	300

Customer information

Declaration of conformity

Radio transmission systems

This vehicle has systems that transmit and / or receive radio waves subject to Directive 2014/53/EU and The Radio Equipment Regulations 2017 by the United Kingdom. The manufacturers of the systems listed below declare conformity with Directive 2014/53/EU and The Radio Equipment Regulations 2017. The full text of the EU declaration of conformity for each system is available at the following internet address: www.opel.com/conformity.

Importer is Vauxhall Motors Limited, MP UK 1-101-135, Chalton House, Luton Road, Chalton, Luton, Bedfordshire, LU4 9TT, United Kingdom.

Infotainment system Multimedia Navi Pro / Multimedia Navi

Continental Automotive Czech Republic s.r.o

Prumyslová 1851, 250 01 Brandys nad Labem, Czech Republic

	Operation frequency (MHz)	Maximum output (dBm)
BT	2402.0 - 2480.0	4.1
Wifi	2412.0 - 2462.0	16.7

Infotainment system Multimedia / Radio

Robert Bosch Car Multimedia GmbH
Robert-Bosch-Strasse 200, 31139 Hildesheim, Germany

Operation frequency:
2400.0 - 2483.5 MHz

Maximum output: 4 dBm

Wireless charger

Continental Automotive GmbH
Siemensstrasse 12, 93055 Regensburg, Germany

Operation frequency:
90.0 - 119.0 kHz

Maximum output:
39.24dB μ A/m at 3m

Antenna module

Hirschmann Car Communication
GmbH

Stuttgarter Strasse 45-51, 72654
Neckartenzlingen, Germany

Operation frequency: N/A

Maximum output: N/A

ASK Industrie SpA

C.P. 110 c/o U.P. RE2, 42121 Reggio
Emilia, Italy

Operation frequency: N/A

Maximum output: N/A

Fiamm France - RCA Spa

12 rue Augustin Fresnel, 78420
Aubergenville, France

Operation frequency: N/A

Maximum output: N/A

Electronic key transmitter

Valeo Comfort and Driving
Assistance

76, rue Auguste Perret 94046 Créteil
- CEDEX France

Operation frequency:
433.05 - 434.79 MHz

Maximum output: -6,85 dBm

Electronic key receiver

Valeo Comfort and Driving
Assistance

76, rue Auguste Perret 94046 Créteil
- CEDEX France

	Operation frequency	Maximum output (dBm)
BT	2402.0 - 2480.0	5.0

Radio 125 kHz - 7.3

Radio remote control transmitter

Huf Hülsbeck & Fürst GmbH & Co.
KG

Steeper Str. 17, 42551 Velbert,
Germany

Operation frequency:
433.05 - 434.79 MHz

Maximum output: -14 dBm

Radio remote control receiver

Aptiv Services France SAS

22 Avenue des Nations ZAC Paris
Nord II 93420 Villepinte France

Operation frequency: 125 kHz

Maximum output: 66 dB μ A/m at 10m

Immobiliser

Kostal Bulgaria Automotive
Pazardzhik

ul. "Sinitevska" 4, 4400 Southern
Industrial Zone, Bulgaria

Operation frequency: 119 - 134 kHz

Maximum output: 72 dB μ A/m at 10m

Radar unit

ZF TRW Autocruise SAS

Secteur de la Pointe du Diable,
Avenue du technopôle, 29280
Plouzane, France

Operation frequency:
76.0 - 77.0 GHz

Maximum output: 28 dBm

BTA Module

Marelli S.p.A.

Viale A. Borletti 61/63, 20011
Corbetta, Italy

	Operation frequency (MHz)	Maximum output (dBm)
GSM 900	880 - 960	33
GSM 1800	1710 - 1880	30
UMTS	880 - 960 1920 - 2170	24 24

ICASA type approval numbers

List of all Independent Communications Authority of South Africa (ICASA) type approval numbers:

TA-2018/5025, TA-2018/5031, TA-2017/2387, TA-2018/1848, TA-2018/208, TA-2017/1106, TA-2017/3180

REACH

Registration, Evaluation, Authorisation and Restriction of Chemicals (REACH) is a European Union regulation adopted to improve the protection of human health and the environment from the risks that can be posed by chemicals. Visit www.opel.com for further information and for access to the Article 33 communication.

Software update

The Infotainment system can download and install selected software updates over a wireless connection.

Notice

The availability of these over-the-air vehicle software updates varies by vehicle and country. Find more information on our website.

Remote device management and remote software and firmware updates

As an integral part of the service related to the performance of subscribed connected service contracts, necessary device management and necessary software and firmware updates related to the software and firmware for the named connected service will be performed remotely, in particular by using over-the-air technology.

For this, a secure radio network connection between the vehicle and the device management server will be established when ignition is switched on and a mobile network is available. Depending on the equipment of the vehicle, connection configuration must be set to **Connected vehicle** to allow the establishment of the radio network connection.

Irrespective of a valid connected service subscription, remote product security or product safety related device management and software and firmware updates will be performed when the processing is

necessary for the compliance with a legal obligation to which the manufacturer is subject (e.g. applicable product liability law, emergency call regulation) or when the processing is necessary in order to protect the vital interests of the respective vehicle users and passengers.

The establishment of a secure radio network connection and the related remote updates are not affected by privacy settings and will be performed in principal after an initiation by the vehicle user following a respective notification.

The system is able to notify receipt of an update as soon as it is connected to an exterior Wi-Fi network or a mobile network. Large updates are downloaded only via the Wi-Fi network.

The availability of an update is notified on the Info Display at the end of a trip with an option of immediate installation or postponement of installation.

The installation time is variable and can take several minutes with a maximum of about 30 minutes. A notification will give an estimate of the duration and a description of the update.

Updates can be checked manually via the Info Display. Follow the on-screen prompts in the respective menu.

Info Display ⇨ 78.

Notice

Steps for downloading and installing updates may vary by vehicle.

For safety reasons and because it requires sustained attention by the driver, the installation must be carried out with the ignition on without starting the engine. The installation cannot be carried out in the following cases:

- engine running
- emergency call in progress
- insufficient vehicle battery charge
- charging the vehicle's high voltage battery

Notice

During the installation process, the vehicle may not be operational.

If the update has failed, seek the assistance of a workshop.

Registered trademarks

Apple Inc.

Apple CarPlay™ is a trademark of Apple Inc.

App Store® and iTunes Store® are registered trademarks of Apple Inc. iPhone®, iPod®, iPod touch®, iPod nano®, iPad® and Siri® are registered trademarks of Apple Inc.

Bluetooth SIG, Inc.

Bluetooth® is a registered trademark of Bluetooth SIG, Inc.

DivX, LLC

DivX® and DivX Certified® are registered trademarks of DivX, LLC.

Google Inc.

Android™ and Google Play™ Store are trademarks of Google Inc.

Velcro Companies

Velcro® is a registered trademark of Velcro Companies.

Verband der Automobilindustrie e.V.

AdBlue® is a registered trademark of the VDA.

Vehicle data recording and privacy

Emergency call data recording and privacy

Data processing

All processing of personal information by the emergency call function complies with the framework for protection of personal information established by regulation 2016/679 (GDPR) and directive 2002/58/EC of the European Parliament and the Council, and in particular, seeks to protect the vital interests of the data subject, in accordance with article 6.1, paragraph d) of regulation 2016/679.

The processing of personal information is strictly limited to the requirements of the emergency call function used with the European emergency call number.

The emergency call function is only able to collect and process the following data relating to the vehicle: chassis number, type (passenger

vehicle or light commercial vehicle), fuel type or power source, three most recent locations and direction of travel, number of passengers and a timestamped log file recording technical data related to the system's operation.

The recipients of the processed data are the emergency call handling centres designated by the relevant national authorities in the territory in which they are located, enabling priority routing and handling of calls to the emergency number.

Data storage

Data contained in the system's memory is not accessible from outside the system until a call is made. The system is not traceable and is not continuously monitored in its normal operation mode.

The data in the system's internal memory is automatically and continuously erased. Only the vehicle's three most recent locations, necessary for the normal functioning of the system, are stored.

When an emergency call is triggered, the data log is stored for no more than 13 hours.

Access to data

You have the right to access the data and, if necessary, submit a request to rectify, erase or restrict the processing of any personal information not processed in accordance with the provisions of Regulation 2016/679 (GDPR). Third parties to which data has been communicated shall be notified of any rectification, erasure or restriction carried out in accordance with the aforementioned directive, unless doing so would be impossible or require a disproportionate effort.

You also have the right to lodge a complaint with the relevant data protection authority.

If you want to claim your above-mentioned rights please contact us per email at privacyrights@mpsa.com.

For more information regarding our contact details please take a look at our Privacy & Cookies Policy on our website.

Event data recorders

Electronic control units are installed in your vehicle. Control units process data which is received by vehicle sensors, for example, or which they generate themselves or exchange amongst themselves. Some control units are necessary for the safe functioning of your vehicle, others assist you while you drive (driver assistance systems), while others provide comfort or infotainment functions.

The following contains general information about data processing in the vehicle. You will find additional information as to which specific data is uploaded, stored and passed on to third parties and for what purpose in your vehicle under the key word Data Protection closely linked to the references for the affected functional

characteristics in the relevant owner's manual or in the general terms of sale. These are also available online.

Operating data in the vehicle

Control units process data for operation of the vehicle.

This data includes, for example:

- vehicle status information (e.g. speed, movement delay, lateral acceleration, wheel rotation rate, "seat belts fastened" display)
- ambient conditions (e.g. temperature, rain sensor, distance sensor)

As a rule such data is transient and is not stored for longer than an operational cycle, and only processed on board the vehicle itself. Often control units include data storage (including the vehicle key). This is used to allow information to be documented temporarily or permanently on vehicle condition, component stress, maintenance requirements and technical events and errors.

Depending on technical equipment levels, the data stored is as follows:

- system component operating states (e.g. fill level, tyre pressure, battery status)
- faults and defects in important system components (e.g. lights, brakes)
- system reactions in special driving situations (e.g. triggering of an airbag, actuation of the stability control systems)
- information on events damaging the vehicle
- for electric vehicles the amount of charge in the high-voltage battery, estimated range

In special cases (e.g. if the vehicle has detected a malfunction), it may be necessary to save data that would otherwise just be volatile.

When you use services (e.g. repairs, maintenance), the operating data saved can be read together with the vehicle identification number and used where necessary. Staff working for the service network (e.g. garages, manufacturers) or third parties (e.g.

breakdown services) can read the data from the vehicle. The same applies to warranty work and quality assurance measures.

Data is generally read via the OBD (On-Board Diagnostics) port prescribed by law in the vehicle. The operating data read documents the technical condition of the vehicle or individual components and assists with fault diagnosis, compliance with warranty obligations and quality improvement. This data, in particular information on component stress, technical events, operator errors and other faults, is transmitted to the manufacturer where appropriate, together with the vehicle identification number. The manufacturer is also subject to product liability. The manufacturer potentially also uses operating data from vehicles for product recalls. This data can also be used to check customer warranty and guarantee claims.

Fault memories in the vehicle can be reset by a service company when carrying out servicing or repairs or at your request.

Comfort and infotainment functions

Comfort settings and custom settings can be stored in the vehicle and changed or reset at any time.

Depending on the equipment level in question, these include

- seat and steering wheel position settings
- chassis and air conditioning settings
- custom settings such as interior lighting

You can input your own data in the infotainment functions for your vehicle as part of the selected features.

Depending on the equipment level in question, these include

- multimedia data such as music, videos or photos for playback in an integrated multimedia system
- address book data for use with an integrated hands-free system or an integrated navigation system

- input destinations
- data on the use of online services

This data for comfort and infotainment functions can be stored locally in the vehicle or be kept on a device that you have connected to the vehicle (e.g. a smartphone, USB stick or MP3 player). Data that you have input yourself can be deleted at any time.

This data can only be transmitted out of the vehicle at your request, particularly when using online services in accordance with the settings selected by you.

Smartphone integration, e.g. Android Auto or Apple CarPlay

If your vehicle is equipped accordingly, you can connect your smartphone or another mobile device to the vehicle so that you can control it via the controls integrated in the vehicle. The smartphone image and sound can be output via the multimedia system in this case. At the same time, specific information is transmitted to your smartphone. Depending on the type of integration,

this includes data such as position data, day / night mode and other general vehicle information. For more information, please see the operating instructions for the vehicle / infotainment system.

Integration allows selected smartphone apps to be used, such as navigation or music playback. No further integration is possible between smartphone and vehicle, in particular active access to vehicle data. The nature of further data processing is determined by the provider of the app used. Whether you can define settings, and if so which ones, is dependent on the app in question and your smartphone's operating system.

Online services

If your vehicle has a radio network connection, this allows data to be exchanged between your vehicle and other systems. The radio network connection is made possible by means of a transmitter device in your vehicle or a mobile device provided by you (e.g. a smartphone). Online functions can be used via this radio network connection. These include online services and applications / apps provided to you by the manufacturer or other providers.

Proprietary services

In the case of the manufacturer's online services, the relevant functions are described by the manufacturer in an appropriate location (e.g. Owner's Manual, the manufacturer's website) and the associated data protection information is provided. Personal data may be used to provide online services. Data exchange for this purpose takes place via a protected connection, e.g. using the manufacturer's IT systems provided for the purpose. Collection,

processing and use of personal data for the purposes of preparation of services take place solely on the basis of legal permission, e.g. in the case of a legally prescribed emergency communication system or a contractual agreement, or by virtue of consent.

You can activate or deactivate the services and functions (which are subject to charges to some extent) and, in some cases, the vehicle's entire radio network connection. This does not include statutory functions and services such as an emergency communication system.

Third party services

If you make use of online services from other providers (third parties), these services are subject to the liability and data protection and usage conditions of the provider in question. The manufacturer frequently has no influence over the content exchanged in this regard.

Therefore, please note the nature, scope and purpose of the collection and use of personal data within the scope of third party services provided by the service provider in question.

Radio Frequency Identification (RFID)

RFID technology is used in some vehicles for functions such as tyre pressure monitoring and immobiliser. It is also used in connection with conveniences such as radio remote controls for door locking / unlocking and starting. RFID technology in Vauxhall vehicles does not use or record personal information or link with any other Vauxhall system containing personal information.

Index

A

Accessories and vehicle
 modifications 245

Active emergency braking.... 76, 200

Adaptive cruise control 192

AdBlue..... 74, 172

Adjustable air vents 159

Advanced lane keep assist... 73, 226

Advanced parking assist..... 211

Airbag and belt tensioners 70

Airbag deactivation 38, 70

Airbag label..... 33

Airbag system 33

Air conditioning regular
 operation 161

Air conditioning system 152

Air intake 160

Air vents..... 159

Antilock brake system 182

Antilock brake system (ABS) 72

Anti-theft alarm system 18

Anti-theft locking system 17

Appearance care..... 276

Armrest..... 29

Audio..... 108, 141

Automatic anti-dazzle 22

Automatic crash notification..... 82

Automatic light control 85

Automatic locking 14

Automatic operation of electric
 parking brake off..... 72

Automatic post collision braking. 204

Automatic transmission 177

Autostop..... 75, 167

Auxiliary heater..... 158

B

Battery discharge protection 92

BlueInjection..... 172

Bluetooth audio streaming.. 111, 143

Bluetooth connection..... 127, 148

Bonnet 251

Brake and clutch fluid..... 283

Brake and clutch system 71

Brake assist 185

Brake fluid 254

Brakes..... 254

Breakdown..... 274

Bulb replacement 258

C

Capacities 290

Car wash mode..... 175, 177

Catalytic converter 171

Central locking system 10

Centre console storage 47

Changing tyre and wheel size ... 264

Charging..... 234

Charging cable..... 232

Charging cable connected..... 75

Charging status.....	238
Charging system	70
Charging types.....	231
Child locks	15
Child restraint installation	
locations	43
Child restraints.....	39
Child restraint systems	39
Climate control systems.....	151
Clock.....	61
Control indicators.....	67
Control of the vehicle	163
Controls.....	57
Convex shape	20
Coolant and antifreeze.....	283
Cruise control	188
Cupholders	46
Curtain airbag system	37
Curve lighting.....	87
D	
DAB.....	108, 141
Danger, Warnings and Cautions ...	4
Daytime running lights	86
Declaration of conformity.....	292
DEF.....	172
Deflation detection system.....	74
Diesel exhaust fluid.....	172
Diesel fuel system bleeding	257
Door open	77

Door panel storage.....	47
Doors.....	16
Drive modes.....	181
Driver alert.....	228
Driver assistance systems.....	187
Driver Information Centre.....	77
Driving characteristics and	
towing tips	243
Driving hints.....	163

E

Electric adjustment	20
Electrical system.....	260
Electric drive unit.....	175
Electric parking brake.....	183
Electric parking brake fault.....	72
Electric power consumption.....	230
Electric range.....	230
Electronic climate control system	154
Electronic key system.....	8
Electronic Stability Control and	
Traction Control system....	73, 186
Emergencies.....	163
Emergency call.....	82
Emergency call data recording	
and privacy.....	296
End-of-life vehicle recovery	249
Engine coolant	253
Engine coolant temperature	73

Engine coolant temperature	
gauge	66
Engine data	288
Engine exhaust	171
Engine identification.....	286
Engine oil	251, 283, 287
Engine oil level monitor.....	66
Engine oil pressure	74
Entry lighting	92
Event data recorders.....	297
Exhaust filter.....	73, 171
Exit lighting	92
Exterior care	276
Exterior light	75
Exterior lighting.....	84
Exterior mirrors.....	20
External devices.....	111, 143

F

Fixed air vents	160
Floor mats.....	278
Folding mirrors	20
Forward collision alert.....	198
Front airbag system	36
Front fog lights	76, 89, 258
Front pedestrian protection.....	204
Front seats.....	27
Fuel.....	239
Fuel consumption - CO ₂ -	
Emissions	242

- | | | | | | |
|-----------------------------------|----------|---------------------------------|---------|-----------------------------------|----------|
| Fuel for diesel engines | 240 | Hill start assist | 185 | Light switch | 84 |
| Fuel for petrol engines | 239 | Horn | 58 | Load compartment | 16, 48 |
| Fuel gauge | 64 | I | | Load compartment cover | 49 |
| Fuses | 260 | Identification plate | 285 | Loading information | 51 |
| G | | Ignition switch positions | 164 | Low beam..... | 75 |
| Gauges..... | 63 | Immobiliser | 19 | Low fuel | 75 |
| Gear shifting..... | 72 | Indicators..... | 67 | M | |
| General information..... | 230, 243 | Inductive charging..... | 62 | Malfunction indicator light | 70 |
| Glovebox | 46 | Info Display..... | 78 | Manual anti-dazzle | 22 |
| H | | Instrument panel illumination | | Manual seat adjustment..... | 28 |
| Hand brake..... | 183 | control | 91 | Manual transmission | 180 |
| Hazard warning flashers | 88 | Instrument panel overview | 55 | Massage..... | 30 |
| Headlight flash | 86 | Interior care | 278 | Matrix-LED headlights..... | 87 |
| Headlight range adjustment | 86 | Interior lighting..... | 91 | Misted light covers | 90 |
| Headlights..... | 84 | Interior lights | 91, 259 | Multimedia..... | 132 |
| Headlights when driving abroad .. | 86 | Interior mirrors..... | 21, 22 | Multimedia Navi Pro..... | 93 |
| Head restraints | 26 | Introduction | 3 | N | |
| Heated mirrors | 21 | J | | Navigation..... | 114 |
| Heated rear window | 24 | Jump starting | 273 | New vehicle running-in | 164 |
| Heated steering wheel | 57 | K | | Number plate light | 259 |
| Heating | 30 | Keys | 6 | O | |
| Heating and ventilation system . | 151 | Keys, locks..... | 6 | Object detection systems..... | 205 |
| High beam | 76, 85 | L | | Odometer | 63 |
| High beam assist..... | 76, 85 | Lane departure warning..... | 223 | Oil, engine..... | 283, 287 |
| High voltage battery..... | 249, 257 | Lane keep assist..... | 72, 224 | Outside temperature | 60 |
| High voltage battery gauge..... | 65 | Lashing eyes | 50 | Overrun cut-off | 167 |
| High voltage battery | | LED headlights..... | 76, 258 | | |
| temperature high..... | 75 | | | | |

- P**
- Parking 170
 - Parking assist 73, 205
 - Parking brake..... 71, 183
 - Parking lights 90
 - Particulate filter..... 171
 - Pedestrian safety alert..... 58
 - Pedestrian safety alert fault..... 76
 - Performing work 250
 - Peripheral lighting..... 92
 - Phone..... 127, 148
 - Phone projection..... 111, 143
 - Post collision braking..... 204
 - Power button..... 164
 - Power indicator gauge..... 65
 - Power outlets 61
 - Power seat adjustment 29
 - Power windows 23
 - Preheating 73
 - Programmable charging..... 237
 - Propulsion types..... 4
 - Puncture..... 269
- Q**
- Quickheat..... 158
- R**
- Radio Frequency Identification (RFID)..... 300
 - Radio remote control 7
 - Rain sensor..... 76
 - RDS..... 108, 141
 - REACH..... 294
 - Reading lights 91
 - Rear floor storage cover 49
 - Rear fog light 76, 90, 259
 - Rear view camera 217
 - Rear window wiper and washer . . 60
 - Recommended fluids and lubricants 283, 287
 - Reduced engine power..... 75
 - Refuelling 241
 - Regenerative braking..... 185
 - Registered trademarks..... 295
 - Reversing lights 90
 - Ride control systems..... 186
 - Roadside assistance..... 82
 - Roller blinds 25
 - Roof load..... 51
 - Roof rack 51
- S**
- Seat belt reminder 69
 - Seat belts 30
 - Seat heating..... 30
 - Seat position 27
 - Selective catalytic reduction..... 172
 - Selector..... 177
 - Service 161, 280
 - Service display 66
 - Service information 280
 - Service vehicle soon 71
 - Side airbag system 36
 - Side blind spot alert..... 216
 - Sidelights..... 84
 - Smart access..... 10, 164
 - Software update..... 294
 - SOS..... 82
 - Spare wheel 269
 - Speech recognition..... 125, 146
 - Speed limiter..... 190
 - Speed limit recognition 188, 190, 192
 - Speedometer 63
 - Sport mode 187
 - Starting and operating..... 164
 - Starting the engine 166
 - Steering..... 163
 - Steering wheel adjustment 57
 - Steering wheel controls 57
 - Stop engine..... 71
 - Stop-start system..... 167
 - Storage..... 46
 - Storage compartments..... 46
 - Sunvisor lights 91
 - Sun visors 24
 - Symbols 4
 - System check..... 71
- T**
- Tachometer 64
 - Tailgate..... 16

Tail lights	259
Temperature preconditioning	158
Three-point seat belt	31
Tools	260
Total vehicle range	66
Tow bar	243
Towing	243, 274
Towing another vehicle	276
Towing the vehicle	274
Traffic Announcements	108, 141
Traffic sign assistant	76, 220
Trailer coupling	243
Trailer towing	243
Tread depth	263
Turn lights	69, 89
Tyre chains	265
Tyre deflation detection system	263
Tyre designations	261
Tyre pressure	262
Tyre pressures	291
Tyre repair kit	265

U

Ultrasonic parking assist	205
Upholstery	278
USB devices	111, 143
USB port	61
Using this manual	3

V

Vauxhall Connect	82
Vehicle battery	254
Vehicle checks	250
Vehicle data	287
Vehicle data recording and privacy	297
Vehicle dimensions	289
Vehicle identification number	285
Vehicle jack	260
Vehicle locator lighting	92
Vehicle messages	80
Vehicle personalisation	81
Vehicle ready	75
Vehicle security	17
Vehicle specific data	3
Vehicle storage	248

Vehicle tools	260
Ventilation	151

W

Warning chimes	80
Warning lights	67
Warning triangle	50
Washer fluid	254
Wheel changing	268
Wheel covers	264
Wheels and tyres	261
Windows	22
Windscreen	22
Windscreen wiper and washer	58
Winter tyres	261
Wiper blade replacement	258

Copyright by Vauxhall Motors Ltd.

The information contained in this publication is effective as of the date indicated below. Vauxhall Motors Ltd. reserves the right to make changes to the technical specifications, features and design of the vehicles relative to the information contained in this publication, as well as changes to the publication itself.

Edition: February 2023, Vauxhall Motors Ltd.

Printed on chlorine-free bleached paper.

ID-VMKBORIE2302-en

