

# Vauxhall VIVA

Owner's Manual



---

## Contents

Introduction .....	2
In Brief .....	5
Keys, Doors, and Windows .....	18
Seats and Restraints .....	31
Storage .....	52
Instruments and Controls .....	59
Lighting .....	85
Infotainment System .....	92
Climate Controls .....	129
Driving and Operating .....	138
Vehicle Care .....	159
Service and Maintenance .....	198
Technical Data .....	205
Customer Information .....	210
Index .....	213

## 2 Introduction

---

### Introduction

#### Introduction

Fuel	Designation	<input type="text"/>		
Engine oil	Grade	<input type="text"/>		
	Viscosity	<input type="text"/>		
Tyre pressure		Tyre size	Front	Rear
	Summer tyres	<input type="text"/>	<input type="text"/>	<input type="text"/>
	Winter tyres	<input type="text"/>	<input type="text"/>	<input type="text"/>
Weights	Gross vehicle weight rating	<input type="text"/>		
	- kerb weight, basic model	<input type="text"/>		
	= Loading	<input type="text"/>		

### Vehicle specific data

Please enter your vehicle's data on the previous page to keep it easily accessible. This information is available in the sections "Service and maintenance" and "Technical data" as well as on the identification plate.

### Introduction

Your vehicle is a designed combination of advanced technology, safety, environmental friendliness and economy.

This Owner's Manual provides you with all the necessary information to enable you to drive your vehicle safely and efficiently.

Make sure your passengers are aware of the possible risk of accident and injury which may result from improper use of the vehicle.

You must always comply with the specific laws and regulations of the country that you are in. These laws may differ from the information in this Owner's Manual.

When this Owner's Manual refers to a workshop visit, we recommend your Vauxhall Authorised workshop. For gas vehicles, we recommend a Vauxhall Authorised workshop licensed to service gas vehicles.

All Vauxhall Authorised workshops provide first-class service at reasonable prices. Experienced mechanics trained by Vauxhall work according to specific Vauxhall instructions.

The customer literature pack should always be kept ready to hand in the vehicle.

### Using this Manual

- This manual describes all options and features available for this model. Certain descriptions, including those for display and menu functions, may not apply to your vehicle due to model variant, country specifications, special equipment or accessories.
- The "In brief" section will give you an initial overview.

- The table of contents at the beginning of this manual and within each section shows where the information is located.
- The index will enable you to search for specific information.
- This Owner's Manual depicts left-hand drive vehicles. Operation is similar for right-hand drive vehicles.
- The Owner's Manual uses the factory engine designations. The corresponding sales designations can be found in the section "Technical data".
- Directional data, e.g. left or right, or front or back, always relate to the direction of travel.
- The vehicle display screens may not support your specific language.
- Display messages and interior labelling are written in bold letters.

## 4 Introduction

---

### Danger, Warning, and Caution

#### **Danger**

Text marked  **Danger** provides information on risk of fatal injury. Disregarding this information may endanger life.

#### **Warning**

Text marked  **Warning** provides information on risk of accident or injury. Disregarding this information may lead to injury.

#### **Caution**

Text marked **Caution** provides information on possible damage to the vehicle. Disregarding this information may lead to vehicle damage.

### Symbols

Page references are indicated with ⇨. ⇨ means "see page".

Thank you for choosing a Vauxhall.

We wish you many hours of pleasurable driving.

**Your Vauxhall Team**

## In Brief

### Initial Drive Information

Unlocking the Vehicle .....	5
Seat Adjustment .....	6
Head Restraint Adjustment .....	7
Safety Belts .....	7
Mirror Adjustment .....	7
Steering Wheel Adjustment .....	8
Instrument Panel Overview .....	9
Exterior Lighting .....	11
Horn .....	12
Windscreen Wiper/Washer .....	13
Climate Controls .....	14
Transmission .....	15
Starting the Engine .....	15
Parking .....	16

## Initial Drive Information

### Unlocking the Vehicle



Press  to unlock the doors and load compartment. Open the doors by pulling the handles.



To open the tailgate, push the touchpad switch under the tailgate moulding.

Unlocks all doors. The hazard warning lights will flash twice.

Radio remote control ⇨ *Radio Remote Control* ⇨ 19,

Central locking system ⇨ *Central Locking System* ⇨ 21,

Load compartment ⇨ *Load Compartment* ⇨ 23.

## 6 In Brief

### Seat Adjustment

#### Seat positioning



Pull handle, slide seat, release handle.

Try to move the seat back and forth to ensure that the seat is locked in place.

Seat position ⇨ *Seat Position* ⇨ 33,  
Seat adjustment ⇨ *Seat Adjustment* ⇨ 33.

#### Danger

Do not sit nearer than 25 cm from the steering wheel, to permit safe airbag deployment.

#### Seat backrests



Pull lever, adjust inclination and release lever. Allow the seat to engage audibly.

Seat position ⇨ *Seat Position* ⇨ 33,  
Seat adjustment ⇨ *Seat Adjustment* ⇨ 33.

#### Seat height



Lever pumping motion

Up : Seat higher

Down : Seat lower

Seat position ⇨ *Seat Position* ⇨ 33,  
Seat adjustment ⇨ *Seat Adjustment* ⇨ 33.

## Head Restraint Adjustment

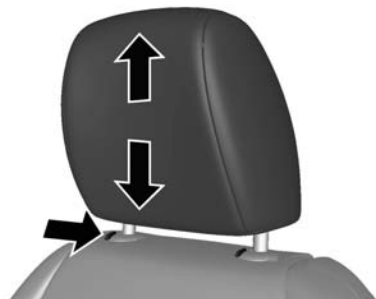

Press release button, adjust height and engage.

## Safety Belts



Pull out the seat belt and engage in belt buckle. The seat belt must not be twisted and must fit close against the body. The backrest must not be tilted back too far (maximum approx. 25°).

To release belt, press red button on belt buckle.

Seat position ⇨ *Seat Position* ⇨ 33,

Seat belts ⇨ *Safety Belts* ⇨ 35,

Airbag system ⇨ *Airbag System* ⇨ 38.

## Mirror Adjustment Interior Mirror



To reduce dazzle, adjust the lever on the underside of the mirror housing.

Interior mirror ⇨ *Manual Rearview Mirror* ⇨ 27.



## 8 In Brief

### Exterior Mirrors

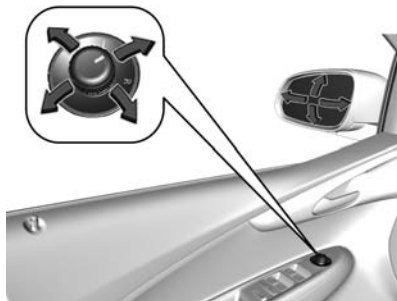

Select the relevant exterior mirror and adjust it.

Convex exterior mirrors ⇨ *Power Mirrors* ⇨ 26.

### Steering Wheel Adjustment



Unlock the lever, adjust the steering wheel, then engage the lever and ensure it is fully locked.

Do not adjust the steering wheel unless the vehicle is stationary and the steering wheel lock has been released.

Airbag system ⇨ *Airbag System* ⇨ 38,

Ignition positions ⇨ *Ignition Positions* ⇨ 139.

## Instrument Panel Overview

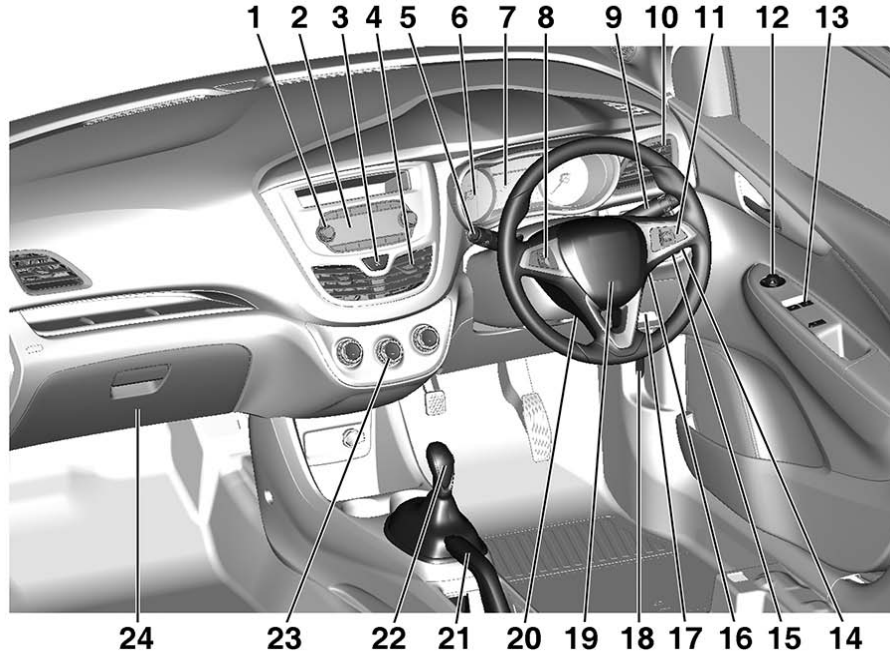

## 10 In Brief

1. Infotainment system on page *Operation* ⇨ 99.
2. Info-Display on page *Overview* ⇨ 93.
3. Hazard warning lights on page *Hazard Warning Flashers* ⇨ 86.
4. Centre air vents on page *Adjustable Air Vents* ⇨ 135.
5. Turn and lane-change signals, headlight flash, dipped beam and main beam on page *Indicator and Lane-Change Signals* ⇨ 86.  
Exit lighting on page *Exit Lighting* ⇨ 90.  
Parking lights on page *Parking Lights* ⇨ 88.
6. Instruments on page *Steering Wheel Adjustment* ⇨ 60.
7. Driver Information Centre on page *Driver Information Centre (DIC)* ⇨ 75.
8. Cruise control, Speed limiter on page *Driver Assistance Systems* ⇨ 152.  
Heated steering wheel on page *Heated Steering Wheel* ⇨ 60.
9. Windscreen wiper, Windscreen washer system, rear wiper, rear washer system on page *Windscreen Wiper/Washer* ⇨ 61.
10. Side air vents on page *Fixed Air Vents* ⇨ 136.
11. Steering wheel controls on page *Steering Wheel Controls* ⇨ 60.
12. Exterior mirrors on page *Convex Mirrors* ⇨ 26
13. Power windows on page *Power Windows* ⇨ 27.  
Central locking system on page *Central Locking System* ⇨ 21.
14. Light switch,  
Headlight range adjustment,  
Front fog lights,  
Rear fog light,  
Instrument illumination on page *Exterior Lamp Controls* ⇨ 85.
15. Traction control system on page *Traction Control System (TCS)* ⇨ 147.  
Automatic engine start/stop on page *Automatic Engine Start/Stop Feature* ⇨ 141.  
City mode on page *Electronic Stability Control (ESC)* ⇨ 148.  
Lane departure warning on page *Lane Departure Warning (LDW)* ⇨ 154.
16. Ignition switch with steering wheel lock on page *Ignition Positions* ⇨ 139.
17. Fuse box on page *Fuses* ⇨ 173.
18. Bonnet release lever on page *Bonnet* ⇨ 161.

19. Horn on page *Horn* ⇨ 61.  
Driver airbag on page *Airbag System* ⇨ 38.
20. Steering wheel adjustment on page *Steering Wheel Adjustment* ⇨ 60.
21. Parking brake on page *Handbrake* ⇨ 146.
22. Selector lever, manual gearbox on page *Manual Gearbox* ⇨ 145.
23. Climate control system on page *Electronic Climate Control System* ⇨ 132.
24. Glove box on page *Glove Box* ⇨ 53.

## Exterior Lighting



Turn light switch.

- : Lights off
- ☉ : Sidelights
- ☉ : Dipped beam

### Fog lights

Press light switch.

- ☉ : Front fog light
- ☉ : Rear fog light

Lighting ⇨ *Exterior Lamp Controls* ⇨ 85.

## Headlight flash, main beam and dipped beam

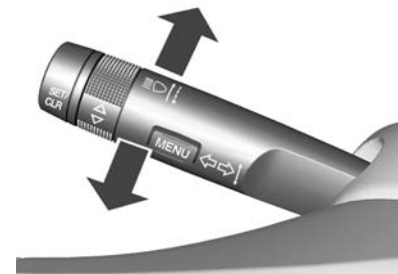

Headlight flash : Pull lever

Main beam : Push lever

Dipped beam : Push or pull lever

Main beam ⇨ *Headlamp Main/Dipped Beam Changer* ⇨ 85.

## 12 In Brief

### Turn and lane-change signals



Lever up : Right indicator

Lever down : Left indicator

Turn and lane-change signals ⇨  
*Indicator and Lane-Change  
Signals* ⇨ 86,

Parking lights ⇨ *Parking  
Lights* ⇨ 88.

### Hazard lights



Operated with .

Hazard warning lights ⇨ *Hazard  
Warning Flashers* ⇨ 86.

### Horn



Press .

## Windscreen Wiper/ Washer

### Windscreen wiper

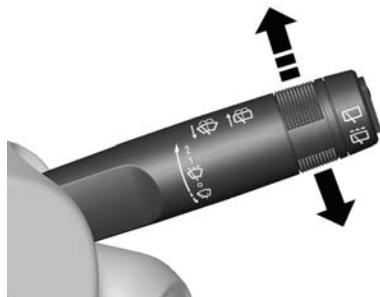

**2** : Fast

**1** : Slow

 : Intermittent wiping

**0** : Off

For a single wipe when the Windscreen wiper is off, press the lever down to position 1x.

Windscreen wiper ⇨ *Windscreen Wiper/Washer* ⇨ 61,

Wiper blade replacement ⇨ *Wiper Blade Replacement* ⇨ 166.

### Windscreen washer system



Pull lever.

Windscreen wiper ⇨ *Windscreen Wiper/Washer* ⇨ 61,

Washer fluid ⇨ *Washer Fluid* ⇨ 164.

## Rear window wiper and washer systems



Press the rocker switch to activate the rear window wiper:

Upper position : Short interval

Lower position: Long interval

Middle position: Off

## 14 In Brief

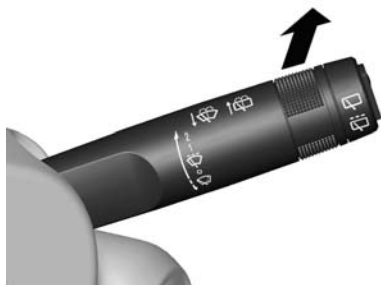

Push lever.

Washer fluid is sprayed on the rear window and the wiper wipes a few times.

Rear window wiper/washer ⇨ *Rear Window Wiper/Washer* ⇨ 62.

### Climate Controls

Heated rear window, heated exterior mirrors



The heating is operated by pressing the .

Heated rear window ⇨ *Heated Rear Window* ⇨ 29.

Demisting and defrosting the windows



Press .

Set the temperature control to the highest level.

Heated rear window  on.

Climate control system ⇨ *Heating and Ventilation System* ⇨ 129.

## Transmission

### Manual gearbox

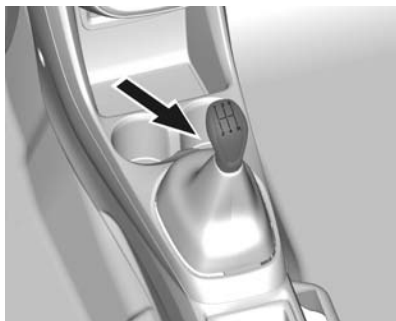

Reverse: with the vehicle stationary, depress clutch pedal and engage the gear.

If the gear does not engage, set the lever to neutral, release the clutch pedal and depress again; then repeat gear selection.

Manual gearbox ⇨ *Manual Gearbox* ⇨ 145.

## Starting the Engine

### Check before starting off

- Tyre pressure and condition ⇨ *Tyre Pressure* ⇨ 179.
- Engine oil level and fluid levels ⇨ *Engine Oil* ⇨ 162.
- All windows, mirrors, exterior lighting and number plates are free from dirt, snow and ice and are operational.
- Proper position of mirrors, seats, and seat belts ⇨ *Convex Mirrors* ⇨ 26, *Seat Position* ⇨ 33, *Three-Point Seat belt* ⇨ 36.
- Brake function at low speed, particularly if the brakes are wet.

### Starting the engine

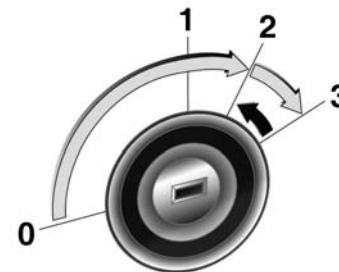

- Turn key to position 1.
- Move the steering wheel slightly to release the steering wheel lock.
- Operate clutch and brake.
- Automatic transmission in P or N.
- Do not operate accelerator pedal.
- Turn key to position 3 and release Starting the engine. ⇨ *Starting the Engine* ⇨ 140.



## 16 In Brief

### Stop-start system



If the vehicle is at a low speed or at a standstill and certain conditions are fulfilled, activate an Autostop as follows:

- depress the clutch pedal
- set the lever in neutral
- release the clutch pedal

An Autostop is indicated by the needle at the AUTOSTOP position in the tachometer.

To restart the engine, depress the clutch pedal again.

Stop-start system ⇨ *Automatic Engine Start/Stop Feature* ⇨ 141.

### Parking

#### Warning

- Do not park the vehicle on an easily ignitable surface. The high temperature of the exhaust system could ignite the surface.
- Always apply handbrake. Pull switch (P) for approx. one second.
- Switch off the engine.
- surface or uphill slope, engage first gear or set the selector lever to position P before removing the ignition key. On an uphill slope, turn the front wheels away from the kerb.

If the vehicle is on a downhill slope, engage reverse gear or set the

(Continued)

#### Warning (Continued)

selector lever to position P before removing the ignition key. Turn the front wheels towards the kerb.

- Remove the ignition key. Turn the steering wheel until the steering wheel lock is felt to engage.

For vehicles with automatic transmission, the key can only be removed when the selector lever is in position P.

- Close the windows.
- Lock the vehicle with  on the radio remote control.
- Activate the anti-theft alarm system ⇨ *Anti-theft Alarm System* ⇨ 24.
- The engine cooling fans may run after the engine has been switched off ⇨ *End-of-Life Vehicle Recovery* ⇨ 161.

- After running at high engine speeds or with high engine loads, operate the engine briefly at a low load or run in neutral for approx.

30 seconds before switching off, in order to protect the turbocharger.

Keys, locks ⇨ *Keys* ⇨ 18,

Laying the vehicle up for a long period of time ⇨ *Vehicle Storage* ⇨ 160.

## 18 Keys, Doors, and Windows

### Keys, Doors, and Windows

#### Keys and Locks

Keys .....	18
Car Pass .....	19
Radio Remote Control .....	19
Memorised Settings .....	20
Central Locking System .....	21
Automatic Door Locks .....	23
Safety Locks .....	23

#### Doors

Load Compartment .....	23
------------------------	----

#### Vehicle Security

Anti-theft Alarm System .....	24
Immobiliser .....	25

#### Exterior Mirrors

Convex Mirrors .....	26
Power Mirrors .....	26
Folding Mirrors .....	26
Heated Mirrors .....	26

#### Interior Mirrors

Manual Rearview Mirror .....	27
------------------------------	----

#### Windows

Manual Windows .....	27
Power Windows .....	27
Heated Rear Window .....	29
Sun Visors .....	29

#### Roof

Sunroof .....	29
---------------	----

### Keys and Locks

#### Keys

##### Replacement keys

The key number is specified on a detachable tag.

The key number must be quoted when ordering replacement keys as it is a component of the immobiliser system.

Locks ⇨ *Exterior Care* ⇨ 195.

##### Lock cylinders

Designed to free-wheel if they are forcefully rotated without the correct key or if the correct key is not fully inserted. To reset, turn cylinder with the correct key until its slot is vertical, remove key and then re-insert it. If the cylinder still free-wheels, turn the key through 180° and repeat operation.



### Key with foldaway key section

Press button to extend.

To fold the key, first press the button.

### Car Pass

The Car Pass contains security related vehicle data and should therefore be kept in a safe place.

When the vehicle is taken to a workshop, this data is required in order to perform certain operations.

### Radio Remote Control



Used to operate:

- central locking system
- anti-theft alarm system

The radio remote control has a range of approx. 20 metres. It can be restricted by external influences.

The hazard lights confirm operation.

Handle with care, protect from moisture and high temperatures and avoid unnecessary operation.

### Fault

If the central locking system cannot be operated with the radio remote control, it may be due to the following:

- Range exceeded,
- Battery voltage too low,
- Frequent, repeated operation of the remote control while not in range, which will require resynchronisation,
- Overload of the central locking system by operating at frequent intervals, the power supply is interrupted for a short time,
- Interference from higher-power radio waves from other sources.

Unlocking ⇨ *Central Locking System* ⇨ 21.

### Radio remote control battery replacement

Replace the battery as soon as the range is reduced.

## 20 Keys, Doors, and Windows



Batteries do not belong in household waste. They must be disposed of at an appropriate recycling collection point.

### Key with foldaway key section



Extend the key and open the unit. Replace the battery (battery type CR 2032), paying attention to the installation position. Close the unit and synchronise.

### Key with fixed key section

Have the battery replaced by a workshop.

### Radio remote control synchronisation

After replacing the battery, unlock the door with the key in the driver's door lock. The radio remote control will be synchronised when the ignition is switched on.

### Memorised Settings

Whenever the key is removed from the ignition switch, the following settings are automatically memorised by the key:

- lighting
- infotainment system
- central locking system
- comfort settings

The saved settings are automatically used the next time the memorised key is inserted into the ignition switch and turned to position 1 ⇨ *Ignition Positions* ⇨ 139.

A precondition is that Personalisation by driver is activated in the personal settings of the Graphic-Info-Display.

This must be set for each key used.

On vehicles equipped with Colour-Info-Display, the personalisation is permanently activated.

Vehicle personalisation ⇨ *Vehicle Personalisation* ⇨ 82.

## Central Locking System



Unlocks and locks doors, load compartment.

**Note:** In the event of an accident in which airbags or belt pretensioners are deployed, the vehicle is automatically unlocked.

### Unlocking



Press .

- To unlock only the driver's door, press  once. To unlock all doors and the load compartment, press  twice, or
- press  once to unlock all doors, load compartment.

The setting can be changed in the menu Settings in the Info-Display.

Vehicle personalisation ⇨ *Vehicle Personalisation* ⇨ 82.

The setting can be saved for the key being used.

Memorised settings ⇨ *Memorised Settings* ⇨ 20.

### Locking

Close doors, load compartment and fuel filler flap.



Press .

If the driver's door is not closed properly, the central locking system will not work.

## 22 Keys, Doors, and Windows

### Central locking button

Locks or unlocks all doors, the load compartment from the passenger compartment.



Press central locking button: the doors are locked or unlocked.

### Fault in radio remote control system

#### Unlocking



Manually unlock the driver's door by turning the key in the lock. Switch on the ignition and press the central locking button to unlock all doors, load compartment.

By switching on the ignition, the anti-theft locking system is deactivated ⇨ *Anti-theft Alarm System* ⇨ 24.

### Locking

Closed all Door, Open the Driver's Door, press central locking button. The vehicle is locked.

Close the Driver's door. Manually lock the driver's door by turning the key.

### Fault in central locking system

#### Unlocking

Manually unlock the driver's door by turning the key in the lock. The other doors can be opened by Pulling up on the sill button and pulling the interior handle to release the latch for other doors. The load compartment cannot be opened.

To deactivate the anti-theft locking system, switch on the ignition ⇨ *Anti-theft Alarm System* ⇨ 24.

## Safety Locks

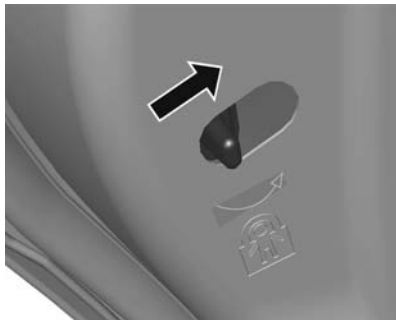

### **Warning**

Use the child locks whenever children are occupying the rear seats.

### Caution

Do not pull the inside door handle while the child security door lock is set to LOCK position. To do so can damage the inside door handle.

To close the child security door lock, move the lever up to the lock position.

To open a rear door when the child security door lock is activated, unlock the door from the inside and open the door from the outside.

To cancel the child security door lock, move the lever down to the unlock position.

## Doors

### Load Compartment

#### Tailgate



#### Opening

To open the tailgate, with all doors unlocked, press the touchpad switch on the underside of pull cup handle and lift up.

Central locking system ⇨ *Central Locking System* ⇨ 21.



## 24 Keys, Doors, and Windows



### Closing

Use the inside pull handle to lower and close the tailgate.

Do not press the touchpad switch while closing the tailgate; it will unlock again.

Central locking system ⇨ *Central Locking System* ⇨ 21.

### General hints for operating tailgate

#### Danger

Do not drive with the tailgate open or ajar, e.g. when transporting bulky objects, since toxic exhaust gases, which cannot be seen or smelled, could enter the vehicle.

This can cause unconsciousness and even death.

#### Caution

Before opening the tailgate check overhead obstructions, such as a garage door, to avoid damage to the tailgate. Always check the moving area above and behind the tailgate.

**Note:** The installation of certain heavy accessories onto the tailgate may affect its ability to remain open.

## Vehicle Security

### Anti-theft Alarm System

It monitors:

- doors, tailgate, bonnet
- ignition

Unlocking the vehicle deactivates both systems simultaneously.

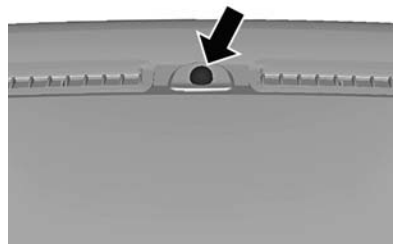

Status LED is integrated in the sensor on top of the instrument panel.

Status during the first 30 seconds of anti-theft alarm system activation:

LED illuminates : test, arming delay.

LED flashes quickly : doors, tailgate or bonnet not completely closed, or system fault.

### Deactivation

Unlocking the vehicle by pressing  on the radio remote control deactivates anti-theft alarm system.

### Alarm

The alarm can be silenced by pressing any button of the radio remote control or by switching on the ignition.

The anti-theft alarm system can be deactivated by pressing the  or switching on the ignition.

### Auto door lock

If any of the doors is not opened or the position of Ignition key is not located in position 1 or position 2 within 3 minutes after unlocking doors using the transmitter, all the doors are locked and anti-theft alarm system is activated automatically.

### Automatic door unlocks

All doors will be automatically unlocked when the impact is delivered to impact sensors while the ignition is position 2.

However, the doors may not be unlocked if mechanical problems occur with the door lock system or battery.

### Immobiliser

The system is part of the ignition switch and checks whether the vehicle is allowed to be started with the key being used.

The immobiliser is activated automatically after the key has been removed from the ignition switch.

If control indicator  flashes when the ignition is on, there is a fault in the system; the engine cannot be started. Switch off the ignition and then repeat the start attempt.

If control indicator  continues flashing, attempt to start the engine using the spare key and seek the assistance of a workshop.

**Note:** The immobiliser does not lock the doors. You should always lock the vehicle after leaving it and switch on the anti-theft alarm system ⇨ *Central Locking System* ⇨ 21, *Anti-theft Alarm System* ⇨ 24.

Control indicator  ⇨ *Immobiliser Light* ⇨ 74.

## 26 Keys, Doors, and Windows

### Exterior Mirrors

#### Convex Mirrors

The convex exterior mirror contains an aspherical area and reduces blind spots. The shape of the mirror makes objects appear smaller, which will affect the ability to estimate distances.

#### Power Mirrors



Select the relevant exterior mirror by turning the control to left (L) or right (R). Then swivel the control to adjust the mirror.

In position 0 no mirror is selected.

#### Folding Mirrors



For pedestrian safety, the exterior mirrors will swing out of their normal mounting position if they are struck with sufficient force. Reposition the mirror by applying slight pressure to the mirror housing.

#### Heated Mirrors



Operated by pressing .

Heating works with the engine running and is switched off automatically after a short time.

## Interior Mirrors

### Manual Rearview Mirror

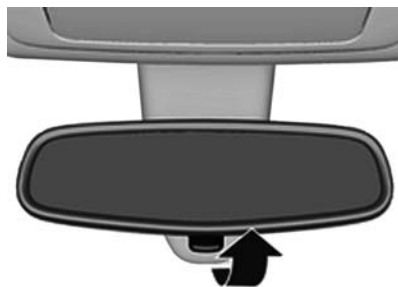

To reduce dazzle, adjust the lever on the underside of the mirror housing.

## Windows

### Manual Windows

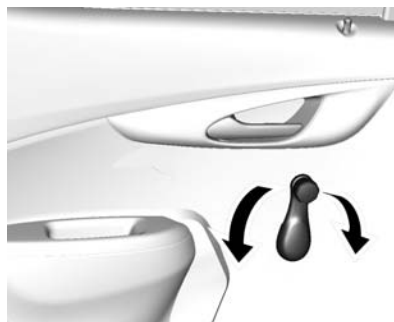

The door windows can be opened or closed with the window winders.

### Power Windows

#### Warning

Take care when operating the power windows. Risk of injury, particularly to children.

(Continued)

#### Warning (Continued)

Be careful when closing the windows. Ensure that nothing becomes trapped in them as they move.



Power windows can be operated with ignition position 2.

Operate the switch for the respective window by pushing to open or pulling to close.

#### Operation

To open the window, press down on the switch.

## 28 Keys, Doors, and Windows

To close the window, lift up on the switch.

Release the switch when the window reaches the desired position.

### Auto up/down

To fully open the window automatically, press the switch fully down. To fully close the window automatically, pull the switch fully up. In automatic operation, the window will fully open or close even if you let go of the switch.

To stop the window at the desired position while the window is in operation, pull up or press down and release the switch to the opposite direction of the movement.

### Safety function

If the window glass encounters resistance above the middle of the window during automatic closing, it is immediately stopped and opened again.

### Overload

If the windows are repeatedly operated at short intervals, the window operation is disabled for some time.

### Initialising the power windows

If the windows cannot be closed automatically (e.g. after disconnecting the vehicle battery), activate the window electronics as follows:

1. Close doors.
2. Switch on ignition.
3. Close the window completely and keep the switch pulled for additional 2 seconds.
4. Repeat for each window.

### Child safety system for rear windows



Press switch  to deactivate rear power windows.

To activate press  again.

## Heated Rear Window



Operated by pressing .

Heating works with the engine running and is switched off automatically after a short time.

## Sun Visors

The sun visors can be folded down or swivelled to the side to prevent dazzling.

If the sun visors have integral mirrors, the mirror covers should be closed when driving.

## Roof

### Sunroof

#### Warning

Take care when operating the sunroof. Risk of injury, particularly to children.

Keep a close eye on the movable parts when operating them.

Ensure that nothing becomes trapped in them as they move.

Sunroof can be operated with ignition on.

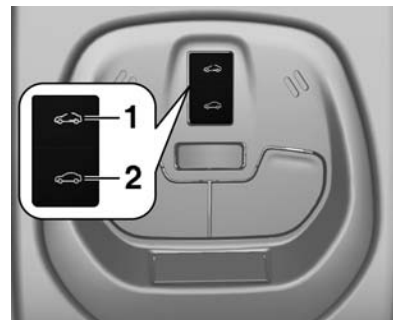

### Raise

Hold switch 1 depressed until the sunroof is raised at the rear.

### Open

From raised position press and release switch 1: the sunroof is opened automatically up to end position. To stop movement before end position, operate switch once more.

## 30 Keys, Doors, and Windows

---

### Close

Hold switch 2 depressed from any position until sunroof is closed completely. Releasing the switch stops movement in any position.

**Note:** If the top of the roof is wet, tilt sunroof, allow water to run off and then open sunroof.

Do not affix any stickers to sunroof.

### Sunblind

The sunblind is manually operated.

Close or open the sunblind by sliding.

When the sunroof is open, the sunblind is always open.

## Seats and Restraints

### Head Restraints

Head Restraints ..... 31

### Front Seats

Seat Position ..... 33

Seat Adjustment ..... 33

Heated Front Seats ..... 35

### Safety Belts

Safety Belts ..... 35

Three-Point Safety Belt ..... 36

### Airbag System

Airbag System ..... 38

Front Airbag System ..... 41

Side Airbag System ..... 42

Curtain Airbag System ..... 42

Airbag On-Off Switch ..... 43

### Child Restraints

Child Restraint Systems ..... 44

Child Restraint Installation

Locations ..... 46

ISOFIX Child Restraint

Systems ..... 49

Top Tether Child Restraint

Systems ..... 51

## Head Restraints

### Position



Only drive with the head restraint set to the proper position.

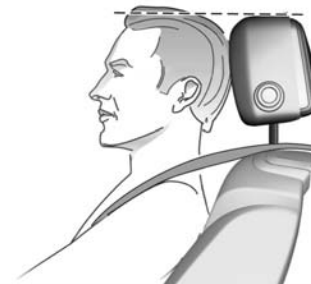

The upper edge of the head restraint should be at upper head level. If this is not possible for extremely tall people, set to highest position, and set to lowest position for small people.



## 32 Seats and Restraints

### Head restraints on front seats

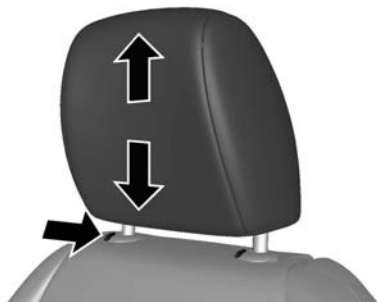

#### Height adjustment

Pull the head restraint upwards and let engage. To move downwards, press the catch to release and push the head restraint downwards.

### Head restraints on rear seats

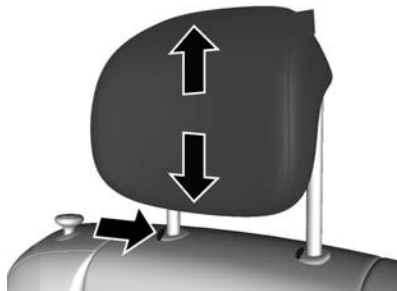

#### Height adjustment

Pull the head restraint upwards or press the catch to release and push the head restraint downwards.

### Removal

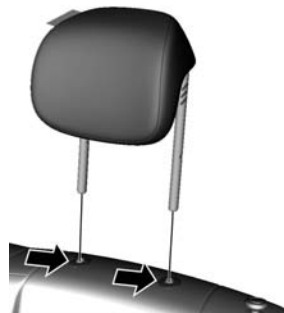

Press both catches, pull the head restraint upwards and remove.

## Front Seats

### Seat Position

#### Warning

Only drive with the seat correctly adjusted.



- Sit with buttocks as far back against the backrest as possible. Adjust the distance between the seat and the pedals so that legs are slightly angled when

pressing the pedals. Slide the front passenger seat as far back as possible.

- Sit with shoulders as far back against the backrest as possible. Set the backrest rake so that it is possible to easily reach the steering wheel with arms slightly bent. Maintain contact between shoulders and the backrest when turning the steering wheel. Do not angle the backrest too far back. We recommend a maximum rake of approx. 25°.
- Adjust the steering wheel ⇨ *Steering Wheel Adjustment* ⇨ 60.
- Set the seat high enough to have a clear field of vision on all sides and on all display instruments. There should be at least one hand of clearance between your head and the headlining. Your thighs should rest lightly on the seat without pressing into it.
- Adjust the head restraint ⇨ *Head Restraints* ⇨ 31.

- Adjust the height of the seat belt ⇨ *Three-Point Seat belt* ⇨ 36.

### Seat Adjustment

#### Danger

Do not sit nearer than 25 cm to the steering wheel, to permit safe airbag deployment.

#### Warning

Never adjust seats while driving as they could move uncontrollably.

#### Warning

Never store any objects under the seats.

## 34 Seats and Restraints

### Seat positioning



Pull handle, slide seat, release handle.

Try to move the seat back and forth to ensure that the seat is locked in place.

### Seat backrests



Pull lever, adjust inclination and release lever. Allow the backrest to engage audibly.

### Seat height





Lever pumping motion

Up : Seat higher

Down : Seat lower

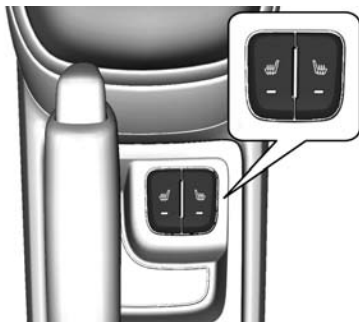
## Heated Front Seats



Activate seat heating by pressing  for the respective front seat.

Activation is indicated by the LED in the button.

Pressing  once more deactivates seat heating.

The passenger seat may take longer to heat up.

Seat heating is operational when engine is running and during an Autostop.

Stop-start system ⇨ *Automatic Engine Start/Stop Feature* ⇨ 141.

## Safety Belts



The seat belts are locked during heavy acceleration or deceleration of the vehicle holding the occupants in the sitting position. Therefore the risk of injury is considerably reduced.

### **Warning**

Fasten safety belt before each trip.

(Continued)

### **Warning (Continued)**

In the event of an accident, people not wearing safety belts endanger their fellow occupants and themselves.

Seat belts are designed to be used by only one person at a time. ⇨ *Child Restraint Systems* ⇨ 44.

Periodically check all parts of the belt system for damage, pollution and proper functionality.

Have damaged components replaced. After an accident, have the belts and triggered belt pretensioners replaced by a workshop.

### **Note**

Make sure that the belts are not damaged by shoes or sharp-edged objects or trapped. Prevent dirt from getting into the belt retractors.

Seat belt reminder  ⇨ *Safety Belt Reminders* ⇨ 69.

## 36 Seats and Restraints

### Seat belt reminder

Front seats are equipped with a seat belt reminder, indicated for driver seat by control indicator  in the tachometer and for passenger seat by the control indicators in the Driver Information Centre  $\Rightarrow$  *Safety Belt Reminders*  $\Rightarrow$  69.

### Belt force limiters

Stress on the body is reduced by the gradual release of the belt during a collision.

### Belt pretensioners

In the event of a head-on or rear-end collision of a certain severity, the seat belts are tightened.

#### **Warning**

Incorrect handling (e.g. removal or fitting of belts) can trigger the belt tensioners with risk of injury.

Deployment of the belt pretensioners is indicated by illumination of control indicator   $\Rightarrow$  *Safety Belt Reminders*  $\Rightarrow$  69.

Triggered belt pretensioners must be replaced by a workshop. Belt pretensioners can only be triggered once.

#### **Note**

Do not affix or install accessories or other objects that may interfere with the operation of the belt pretensioners. Do not make any modifications to belt pretensioner components as this will invalidate the vehicle type approval.

## Three-Point Safety Belt

### Fastening seat belt



Withdraw the belt from the retractor, guide it untwisted across the body and insert the latch plate into the buckle. Tighten the lap belt regularly whilst driving by pulling the shoulder belt

Seat belt reminder  $\Rightarrow$  *Safety Belt Reminders*  $\Rightarrow$  69.



Loose or bulky clothing prevents the belt from fitting snugly. Do not place objects such as handbags or mobile phones between the belt and your body.

**⚠ Warning**

The belt must not rest against hard or fragile objects in the pockets of your clothing.

### Removing seat belt

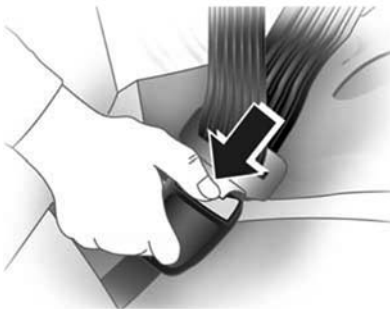

To release belt, press red button on belt buckle.

### Using the seat belt while pregnant



**⚠ Warning**

The lap belt must be positioned as low as possible across the pelvis to prevent pressure on the abdomen.

## 38 Seats and Restraints

### Airbag System

The airbag system consists of a number of individual systems depending on the scope of equipment.

When triggered the airbags inflate within milliseconds. They also deflate so quickly that it is often unnoticeable during the collision.

#### Warning

If handled improperly the airbag systems can be triggered in an explosive manner.

#### Note

The airbag systems and belt pretensioner control electronics are located in the centre console area. Do not put any magnetic objects in this area.

Do not stick anything on the airbag covers and do not cover them with other materials.

Each airbag is triggered only once. Have deployed airbags replaced by a workshop. Furthermore, it might be necessary to have the steering wheel, the instrument panel, parts of the panelling, the door seals, handles and the seats replaced.

Do not make any modifications to the airbag system as this will invalidate the vehicle type approval.

When the airbags inflate, escaping hot gases may cause burns.

Control indicator  for airbag systems ⇨ *Airbag and Seat belt Tensioner Light* ⇨ 70.

### Child restraint systems on front passenger seat with airbag systems

Warning according to ECE R94.02:



EN: NEVER use a rearward-facing child restraint on a seat protected by an ACTIVE AIRBAG in front of it; DEATH or SERIOUS INJURY to the CHILD can occur.

DE: Nach hinten gerichtete Kindersitze NIEMALS auf einem Sitz verwenden, der durch einen davor befindlichen AKTIVEN AIRBAG geschützt ist, da dies den

TOD oder SCHWERE  
VERLETZUNGEN DES KINDES zur  
Folge haben kann.

FR: NE JAMAIS utiliser un siège  
d'enfant orienté vers l'arrière sur un  
siège protégé par un COUSSIN  
GONFLABLE ACTIF placé devant  
lui, sous peine d'infliger des  
BLESSURES GRAVES, voire  
MORTELLLES à l'ENFANT.

ES: NUNCA utilice un sistema de  
retención infantil orientado hacia  
atrás en un asiento protegido por un  
AIRBAG FRONTAL ACTIVO.  
Peligro de MUERTE o LESIONES  
GRAVES para el NIÑO.

RU: ЗАПРЕЩАЕТСЯ  
устанавливать детское  
удерживающее устройство лицом  
назад на сиденье автомобиля,  
оборудованном фронтальной  
подушкой безопасности, если  
ПОДУШКА НЕ ОТКЛЮЧЕНА! Это  
может привести к СМЕРТИ или  
СЕРЬЕЗНЫМ ТРАВМАМ  
РЕБЕНКА.

NL: Gebruik NOOIT een  
achterwaarts gericht kinderzitje op  
een stoel met een ACTIEVE

AIRBAG ervoor, om DODELIJK of  
ERNSTIG LETSEL van het KIND te  
voorkomen.

DA: Brug ALDRIG en bagudvendt  
autostol på et forsæde med AKTIV  
AIRBAG, BARNET kan komme i  
LIVSFARE eller komme  
ALVORLIGT TIL SKADE.

SV: Använd ALDRIG en bakåtvänd  
barnstol på ett säte som skyddas  
med en framförvarande AKTIV  
AIRBAG. DÖDSFALL eller  
ALLVARLIGA SKADOR kan drabba  
BARNET.

FI: ÄLÄ KOSKAAN sijoita  
taaksepäin suunnattua lasten  
turvaistuinta istuimelle, jonka  
edessä on AKTIIVINEN  
TURVATYYNY, LAPSI VOI KUOLLA  
tai VAMMAUTUA VAKAVASTI.

NO: Bakovervendt  
barnesikringsutstyr må ALDRI  
brukes på et sete med AKTIV  
KOLLISJONSPUTE foran, da det  
kan føre til at BARNET utsettes for  
LIVSFARE og fare for ALVORLIGE  
SKADER.

PT: NUNCA use um sistema de  
retenção para crianças voltado para  
trás num banco protegido com um  
AIRBAG ACTIVO na frente do  
mesmo, poderá ocorrer a PERDA  
DE VIDA ou FERIMENTOS  
GRAVES na CRIANÇA.

IT: Non usare mai un sistema di  
sicurezza per bambini rivolto  
all'indietro su un sedile protetto da  
AIRBAG ATTIVO di fronte ad esso:  
pericolo di MORTE o LESIONI  
GRAVI per il BAMBINO!

EL: ΠΟΤΕ μη χρησιμοποιείτε  
παιδικό κάθισμα ασφαλείας με φορά  
προς τα πίσω σε κάθισμα που  
προστατεύεται από μετωπικό  
ΕΝΕΡΓΟ ΑΕΡΟΣΑΚΟ, διότι το παιδί  
μπορεί να υποστεί ΘΑΝΑΣΙΜΟ ή  
ΣΟΒΑΡΟ ΤΡΑΥΜΑΤΙΣΜΟ.

PL: NIE WOLNO montować fotelika  
dziecięcego zwróconego tyłem do  
kierunku jazdy na fotelu, przed  
którym znajduje się WŁĄCZONA  
PODUSZKA POWIETRZNA.  
Niezastosowanie się do tego  
zalecenia może być przyczyną  
ŚMIERCI lub POWAŻNYCH  
OBRAŻEŃ u DZIECKA.



## 40 Seats and Restraints

TR: Arkaya bakan bir çocuk emniyet sistemini KESİNLİKLE önünde bir AKTİF HAVA YASTIĞI ile korumakta olan bir koltukta kullanmayınız. ÇOCUK ÖLEBİLİR veya AĞIR ŞEKİLDE YARALANABİLİR.

UK: НИКОЛИ не використовуйте систему безпеки для дітей, що встановлюється обличчям назад, на сидінні з УВІМКНЕНОЮ ПОДУШКОЮ БЕЗПЕКИ, інакше це може призвести до СМЕРТІ чи СЕРІОЗНОГО ТРАВМУВАННЯ ДИТИНИ.

HU: SOHA ne használjon hátrafelé néző biztonsági gyerekülést előlről AKTÍV LÉGZSÁKKAL védett ülésen, mert a GYERMEK HALÁLÁT vagy KOMOLY SÉRÜLÉSÉT okozhatja.

HR: NIKADA nemojte koristiti sustav zadržavanja za djecu okrenut prema natrag na sjedalu s AKTIVNIM ZRAČNIM JASTUKOM ispred njega, to bi moglo dovesti do SMRTI ili OZBILJNJIH OZLJEDA za DIJETE.

SL: NIKOLI ne nameščajte otroškega varnostnega sedeža, obrnjenega v nasprotni smeri vožnje, na sedež z AKTIVNO ČELNO ZRAČNO BLAZINO, saj pri tem obstaja nevarnost RESNIH ali SMRTNIH POŠKODB za OTROKA.

SR: NIKADA ne koristiti bezbednosni sistem za decu u kome su deca okrenuta unazad na sedištu sa AKTIVNIM VAZDUŠNIM JASTUKOM ispred sedišta zato što DETE može da NASTRADA ili da se TEŠKO POVREDI.

MK: НИКОГАШ не користете детско седиште свртено наназад на седиште заштитено со АКТИВНО ВОЗДУШНО ПЕРНИЧЕ пред него, затоа што детето може ДА ЗАГИНЕ или да биде ТЕШКО ПОВРЕДЕНО.

BG: НИКОГА не използвайте детска седалка, гледаща назад, върху седалка, която е защитена чрез АКТИВНА ВЪЗДУШНА ВЪЗГЛАВНИЦА пред нея - може да се стигне до СМЪРТ или СЕРИОЗНО НАРАНЯВАНЕ на ДЕТЕТО.

RO: Nu utilizați NICIODATĂ un scaun pentru copil îndreptat spre partea din spate a mașinii pe un scaun protejat de un AIRBAG ACTIV în fața sa; acest lucru poate duce la DECESUL sau VĂTĂMAREA GRAVĂ a COPILULUI.

CS: NIKDY nepoužívejte dětský zádržný systém instalovaný proti směru jízdy na sedadle, které je chráněno před sedadlem AKTIVNÍM AIRBAGEM. Mohlo by dojít k VÁŽNÉMU PORANĚNÍ nebo ÚMRTÍ DÍTĚTE.

SK: NIKDY nepoužívajte detskú sedačku otočenú vzad na sedadle chránenom AKTÍVNYM AIRBAGOM, pretože môže dôjsť k SMRTI alebo VÁŽNYM ZRANENIAM DIEŤAŤA.

LT: JOKIU BŪDU nemontuokite atgal atgręžtos vaiko tvirtinimo sistemos sėdynėje, prieš kuria įrengta AKTYVI ORO PAGALVĖ, nes VAIKAS GALI ŽŪTI arba RIMTAI SUSIŽALOTI.

LV: NEKĀDĀ GADĪJUMĀ neizmantojiet uz aizmuguri vērstu bērnu sēdekļlīti sēdvietā, kas tiek aizsargāta ar tās priekšā uzstādītu AKTĪVU DROŠĪBAS SPILVENU, jo pretējā gadījumā BĒRNS var gūt SMAGAS TRAUMAS vai IET BOJĀ.

ET: ĀRGE kasutage tahapoole suunatud lapseturvaistet istmel, mille ees on AKTIIVSE TURVAPADJAGA kaitstud iste, sest see vöib põhjustada LAPSE SURMA või TÖSISE VIGASTUSE.

MT: QATT tuža tražžin għat-tfal li jħares lejn in-naħa ta' wara fuq sit protett b'AIRBAG ATTIV quddiemu; dan jista' jikkawħa l-MEWT jew ĠRIEFI SERJI lit-TFAL.

Beyond the warning required by ECE R94.02, for safety reasons never use a forward-facing child restraint system on the passenger seat with an active front airbag.

**⚠ Danger**

Do not use a child restraint system on the passenger seat with active front airbag.

The airbag label is located on both sides of the front passenger sun visor.

Airbag deactivation ⇨ *Airbag On-Off Switch* ⇨ 43.

## Front Airbag System

The front airbag system consists of one airbag in the steering wheel and one in the instrument panel on the front passenger side. These can be identified by the word AIRBAG.

The front airbag system is triggered in the event of a front-end impact of a certain severity. The ignition must be switched on.

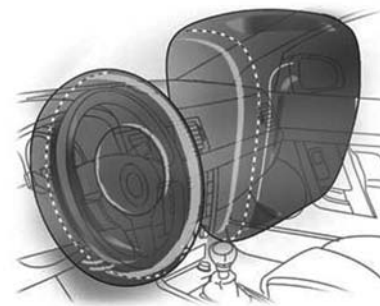

The inflated airbags cushion the impact, thereby reducing the risk of injury to the upper body and head of the front seat occupants considerably.

**⚠ Warning**

Optimum protection is only provided when the seat is in the proper position

⇨ *Seat Position* ⇨ 33.

Keep the area in which the airbag inflates clear of obstructions.

(Continued)

## 42 Seats and Restraints

### Warning (Continued)

Fit the seat belt correctly and engage securely. Only then the airbag is able to protect.

### Side Airbag System

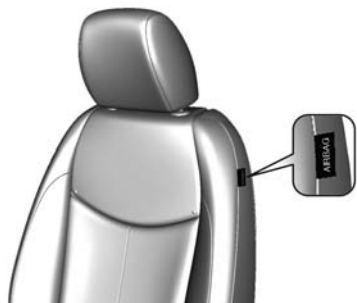

The side airbag system consists of an airbag in each front seat backrest. This can be identified by the word AIRBAG.

The side airbag system is triggered in the event of a side impact of a certain severity. The ignition must be switched on.

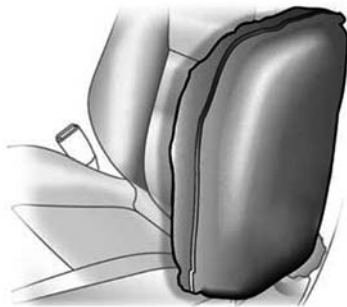

The inflated airbags cushion the impact, thereby reducing the risk of injury to the upper body and pelvis in the event of a side-on collision considerably.

### Warning

Keep the area in which the airbag inflates clear of obstructions.

### Note

Only use protective seat covers that have been approved for the vehicle. Be careful not to cover the airbags.

### Curtain Airbag System

The curtain airbag system consists of an airbag in the roof frame on each side. This can be identified by the word AIRBAG on the roof pillars.

The curtain airbag system is triggered in the event of a side-on impact of a certain severity. The ignition must be switched on.

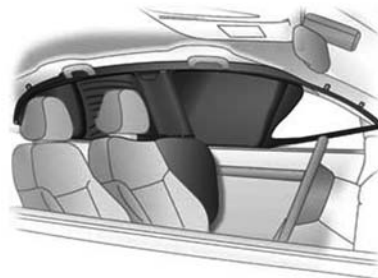

The inflated airbags cushion the impact, thereby reducing the risk of injury to the head in the event of a side-on impact considerably.

**Warning**

Keep the area in which the airbag inflates clear of obstructions.

The hooks on the handles in the roof frame are only suitable for hanging up light articles of clothing, without coat hangers. Do not keep any items in these clothes.

### Airbag On-Off Switch

The front passenger airbag system must be deactivated if a child restraint system is to be fitted on this seat. The side airbag and curtain airbag systems, the belt pretensioners and all driver airbag systems will remain active.



The front passenger airbag system can be deactivated via a key-operated switch on the left side of the instrument panel.

Use the ignition key to choose the position:

**OFF** : Front passenger airbags are deactivated and will not inflate in the event of a collision. Control indicator **OFF** illuminates continuously.

A child restraint system can be installed in accordance with the chart.

**ON** : Front passenger airbags are activated. No child restraint systems can be installed.

**Danger**

Risk of fatal injury for a child using a child restraint system on a seat with activated front passenger airbag.

Risk of fatal injury for an adult person on a seat with deactivated front passenger airbag.



If the control indicator **OFF** illuminates for approx. 60 seconds after the ignition is switched on, the front passenger airbag system will

## 44 Seats and Restraints

inflate in the event of a collision. Status remains until the next change.

If both control indicators are illuminated at the same time, there is a system failure. The status of the system is not discernible, therefore no person is allowed to occupy the front passenger seat. Contact a workshop immediately.

Change status only when the vehicle is stationary with the ignition off.

Status remains until the next change.

Control indicator for airbag deactivation ⇨ *Airbag On-Off Light*  
⇨ 70.

### Child Restraints

#### Child Restraint Systems

We recommend the following child restraint systems which are tailored specifically to the vehicle:

- Group 0, Group 0+  
Maxi-Cosi Cabriofix with ISOFIX base, for children up to 13 kg.
- Group I  
Duo Plus with ISOFIX and Top tether, in this group.
- Group II, Group III  
Kidfix with or without ISOFIX for children from 15kg up to 36kg.

When a child restraint system is being used, pay attention to the following usage and installation instructions and also those supplied with the child restraint system.

Always comply with local or national regulations. In some countries, the use of child restraint systems is forbidden on certain seats.

#### **Danger**

If using a rear-facing child restraint system on the front passenger seat, the airbag system for the front passenger seat must be deactivated. This also applies to certain forward-facing child restraint systems as indicated in the tables.

Airbag deactivation ⇨ *Airbag On-Off Switch* ⇨ 43.

### **Selecting the right system**

The rear seats are the most convenient location to fasten a child restraint system.

Children should travel facing rearwards in the vehicle as long as possible. This ensures that the child's backbone, which is still very weak, is under less strain in the event of an accident.

Suitable are restraint systems that comply with valid UN ECE regulations. Check local laws and regulations for mandatory use of child restraint systems.

Ensure that the child restraint system to be installed is compatible with the vehicle type.

Ensure that the mounting location of the child restraint system within the vehicle is correct, see following tables.

Allow children to enter and exit the vehicle only on the side facing away from the traffic.

When the child restraint system is not in use, secure the seat with a seat belt or remove it from the vehicle.

### **Note**

Do not affix anything on the child restraint systems and do not cover them with any other materials.

A child restraint system which has been subjected to stress in an accident must be replaced.

## 46 Seats and Restraints

### Child Restraint Installation Locations

#### Permissible options for fitting a child restraint system

Weight and age class	On front passenger seat		On rear outboard seats	On rear centre seat
	activated airbag	deactivated airbag		
Group 0: up to 10 kg or approx. 10 months	X	U 1)	U	X
Group 0+: up to 13 kg or approx. 2 years	X	U 1)	U	X
Group I: 9 to 18 kg or approx. 8 months to 4 years	X	U 1)	U	X
Group II: 15 to 25 kg or approx. 3 to 7 years	X	X	U	X
Group III: 22 to 36 kg or approx. 6 to 12 years	X	X	U	X

**U** : Universal suitability in conjunction with three-point seat belt.

**X** : No child restraint system permitted in this weight class.

**1)** : Adjust front seat backrest inclination to upright position.

**Permissible options for fitting an ISOFIX child restraint system**

Weight and age class	Size Class	Fixture	On front passenger seat	On rear outboard seats	On rear centre seat
Group 0: up to 10 kg or approx. 10 months	F	ISO/L1	X	X	X
	G	ISO/L2	X	X	X
	E	ISO/R1	X	IL	X
Group 0+: up to 13 kg or approx. 2 years	E	ISO/R1	X	IL	X
	D	ISO/R2	X	IL	X
	C	ISO/R3	X	IL 1)	X
Group I: 9 to 18 kg or approx. 8 months to 4 years	D	ISO/R2	X	IL	X
	C	ISO/R3	X	IL 1)	X
	B	ISO/F2	X	IL, IUF	X
	B1	ISO/F2X	X	IL, IUF	X
	A	ISO/F3	X	IL, IUF	X



## 48 Seats and Restraints

Weight and age class	Size Class	Fixture	On front passenger seat	On rear outboard seats	On rear centre seat
Group II: 15 to 25 kg or approx. 3 to 7 years			X	IL	X
Group III: 22 to 36 kg or approx. 6 to 12 years			X	IL	X

### Note

Move front passenger seat to most forward position or move forward until child restraint system does not have any interference with front seat backrest.

**1)** : Only applicable for rear outer behind passenger's seat with foremost seating position and backrest upright.

**IL** : Suitable for particular ISOFIX restraint systems of the "specific-vehicle", "restricted" or "semi-universal" categories.

The ISOFIX restraint system must be approved for the specific vehicle type.

**IUF** : Suitable for ISOFIX forward-facing child restraint systems of universal category approved for use in this weight class.

**X** : No ISOFIX child restraint system approved in this weight class.

### ISOFIX size class and seat device

**A - ISO/F3** : Forward-facing child restraint system for children of maximum size in the weight class 9 to 18 kg.

**B - ISO/F2** : Forward-facing child restraint system for smaller children in the weight class 9 to 18 kg.

**B1 - ISO/F2X** : Forward-facing child restraint system for smaller children in the weight class 9 to 18 kg.

**C - ISO/R3** : Rear-facing child restraint system for children of maximum size in the weight class up to 13 kg.

**D - ISO/R2** : Rear-facing child restraint system for smaller children in the weight class up to 13 kg.

**E - ISO/R1** : Rear-facing child restraint system for young children in the weight class up to 13 kg.

**F - ISO/L1** : Left lateral-facing position CRS (carry-cot).

**G - ISO/L2** : Right lateral-facing position CRS (carry-cot).

### ISOFIX Child Restraint Systems

Fasten vehicle-approved ISOFIX child restraint systems to the ISOFIX mounting brackets. Specific vehicle ISOFIX child restraint system positions are marked in the table by IL.

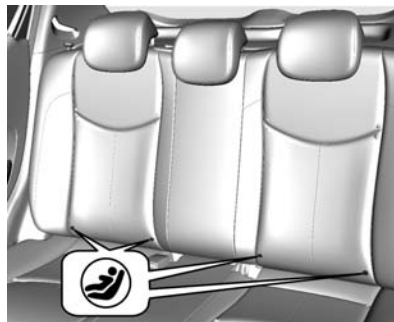

ISOFIX mounting brackets are indicated by the ISOFIX logo on the backrest.

Remove rear head restraint before mounting a child restraint system, if required ⇨ *Child Restraint Installation Locations* ⇨ 46.

ISOFIX child restraint systems of universal category positions are marked in the table by IUF.

Remove rear head restraint before mounting a child restraint system if required.

Route, attach, and tighten the top tether according to your child restraint instructions and the following instructions:

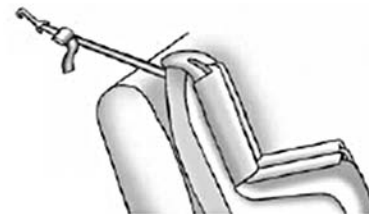

If you are using a single tether in an outboard seating position and the head restraint has been removed, route the tether over the backrest.

## 50 Seats and Restraints

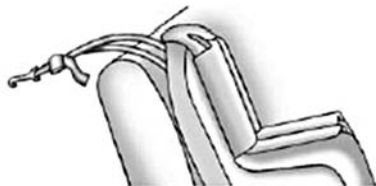

If you are using a dual tether in an outboard seating position and the head restraint has been removed, route the tether over the backrest.



If the rear outboard seating position you are using has an adjustable head restraint and you are using a single tether, raise the head restraint and route the tether under the head restraint and in between the head restraint posts.



If the rear outboard seating position you are using has an adjustable head restraint and you are using a dual tether, raise the head restraint and route the tether under the head restraint and around the head restraint posts.

## Top Tether Child Restraint Systems

The vehicle has two fastening eyes on the backside of the rear seats.

Top-Tether fastening eyes are marked with the symbol  for a child seat.

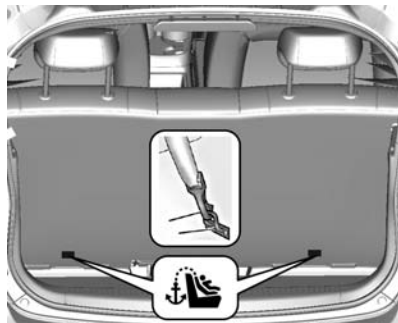

In addition to the ISOFIX mounting, fasten the Top-Tether strap to the Top-Tether fastening eyes.

ISOFIX child restraint systems of universal category positions are marked in the table by IUF.

Remove rear head restraint before mounting a child restraint system if required ⇨ *Child Restraint Installation Locations* ⇨ 46.

## 52 Storage

### Storage

#### Storage Compartments

Storage Compartments .....	52
Instrument Panel Storage .....	52
Glove Box .....	53
Cupholders .....	53

#### Luggage/Load Locations

Load Compartment .....	53
------------------------	----

#### Additional Storage Features

Rear Compartment/Storage	
Panel Cover .....	56
Convenience Net .....	56
Warning Triangle .....	56
First Aid Kit .....	57

#### Information on Loading the Vehicle

Information on Loading the Vehicle .....	57
--	----

### Storage Compartments

#### Warning

Do not store heavy or sharp objects in the storage compartments. Otherwise, the storage compartment lid could open and vehicle occupants could be injured by objects being thrown around in the event of hard braking, a sudden change in direction or an accident.

### Instrument Panel Storage



The storage is used for small articles, etc.

## Glove Box



Inside the glovebox there is a compartment for the Owner's Manual. Pull the lug to open the compartment. The glovebox should be closed whilst driving.

## Cupholders



A cupholder is located in the centre console.

## Luggage/Load Locations

### Load Compartment

#### Load compartment extension

Caution
First turn down the rear seat cushion before folding the rear seat backrest. Disregard may lead to damage to the rear seat.
1. Push head restraints down by pressing the catch.

1. Push head restraints down by pressing the catch.

**Note:** To ensure enough room for rear seat cushion operation, slide the front seat forward and move the front seat backrest upright.

## 54 Storage



2. Pull the strap under the seat cushion and turn down the seat cushion.

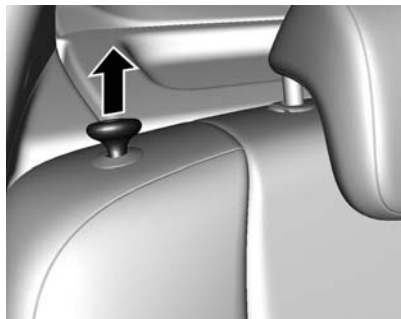

3. Pull the release lever on top of the rear backrest.



4. Fold the backrest forward and down.



5. Put the seat belts for the outboard seats into the belt guides.

To return the backrest to the original position, pull out the seat belt from the belt guides and lift backrest up. Push backrest firmly into place.

### **Warning**

When folding up, ensure that backrests are securely locked in position before driving. Failure to do so may result in personal injury or damage to the load or vehicle in the event of hard braking or a collision.

Make sure the seat belts are not pinched by the latch.

The centre rear seat belt may lock when you raise the backrest. If this happens, allow the belt to go back all the way and repeat operation.

If the seat belt is still locked, turn down the seat cushion and try again.

To return the rear seat cushion, put the rear part of the seat cushion in its original position ensuring that the seat belt buckle straps are not

twisted or caught under the seat cushion, then push the front part of the seat cushion firmly down until it latches.

### Caution

When returning rear seat backrest to the upright position, place the rear seat belt and buckles between the rear seat backrest and one cushion. Make sure the rear seat belt and buckles do not get pinched under the rear seat cushion.

Make sure the seat belts are not twisted or caught in the seat backrest and are arranged in their proper position.

**Notice:** The luggage compartment shall contain all fittings installed in production by the car manufacturer (spare wheel, jack, etc.). Other features, either not installed or only optional, such as first-aid-kit or fire extinguisher, shall not be considered.

**Where special features such as a folding or removable rear seat of backrest have been provided by the manufacturer to obtain maximum loading volume, the measurements shall be made with the following loading limits.**

Front loading limit: the rear side of the backrest of the seats situated immediately in front of the luggage compartment set at the normal driving or riding position as defined by the manufacturer, and/or the folded rear seats; the rear seats and/or backrest folded or removed, with the front loading limit above the backrest being a vertical plane tangential to the rear side of the front seat backrest and the load height limited by the roof headlining.

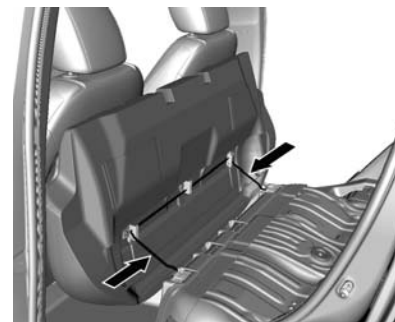

To remove the rear seat cushion, push the hinges in direction of arrow.



## 56 Storage

### Additional Storage Features

#### Rear Compartment/ Storage Panel Cover

##### Load compartment cover



You can place small objects or hide items stored in the cargo area.

To use the panel, hang each loop to both anchors of the tailgate.

When not in use, place the panel in rear seat backward.

**Note:** If it is located in inappropriate place may cause rattle noise and wear by contact with rear seat.

#### Caution

Do not place heavy objects in panel.

When loading and unloading storage panel cover, turn it for easy installation due to large storage panel cover than tailgate.

#### Convenience Net

You can carry small loads with your optional convenience net.

To install the net, hang each loop in the upper corner of the net to both anchors of the back panel.

#### Caution

The convenience net is designed for small loads. Do not carry heavy objects in your convenience net.

### Warning Triangle

#### Vehicles with tyre repair kit



Stow the warning triangle in the vehicle tool box below the floor cover in the load compartment.

### Vehicles with spare wheel

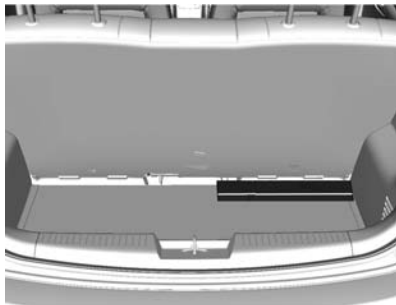

Stow the warning triangle in the space on the load compartment.

### First Aid Kit

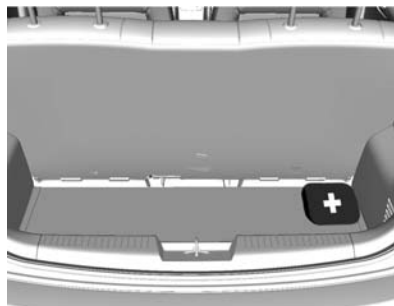

Stow the first aid kit in the space on the load compartment.

### Information on Loading the Vehicle

- Heavy objects in the load compartment should be placed against the seat backrests. Ensure that the backrests are securely engaged. If objects can be stacked, heavier objects should be placed at the bottom.
- Secure objects in load compartment to prevent sliding.
- When transporting objects in the load compartment, the backrests of the rear seats must not be angled forward.
- Do not allow the load to protrude above the upper edge of the backrests.
- Do not place any objects on the load compartment cover or the instrument panel, and do not cover the sensor on top of the instrument panel.

## 58 Storage

- The load must not obstruct the operation of the pedals, parking brake and gear selector lever, or hinder the freedom of movement of the driver. Do not place any unsecured objects in the interior.
- Do not drive with an open load compartment.

### **Warning**

Always make sure that the load in the vehicle is securely stowed.

Otherwise objects can be thrown around inside the vehicle and cause personal injury or damage to the load or car.

- The payload is the difference between the permitted gross vehicle weight (see identification plate ⇨ *Vehicle Identification Number (VIN)* ⇨ 205) and the kerb weight. For the kerb weight in detail, refer to the technical data section.

The kerb weight includes weights for the driver (68 kg), luggage (7 kg) and all fluids (tank 90% full).

Optional equipment and accessories increase the kerb weight.

- Driving with a roof load increases the sensitivity of the vehicle to cross-winds and has a detrimental effect on vehicle handling due to the vehicle's higher centre of gravity. Distribute the load evenly and secure it properly with retaining straps. Adjust the tyre pressure and vehicle speed according to the load conditions. Check and retighten the straps frequently.

## Instruments and Controls

### Controls

Steering Wheel Adjustment	60
Steering Wheel Controls	60
Heated Steering Wheel	60
Horn	61
Windscreen Wiper/Washer	61
Rear Window Wiper/Washer	62
Outside Temperature	63
Clock	63
Power Sockets	63

### Warning Lights, Gauges, and Indicators

Speedometer	64
Mileometer	64
Trip Odometer	64
Rev Counter	65
Fuel Gauge	65
Control Indicators	66
Engine Coolant Temperature Gauge	68
Service Display	68
Indicator	69
Seat Belt Reminders	69
Airbag and Safety Belt Tensioner	70

Airbag On-Off Light	70
Charging System Light	70
Malfunction Indicator Lamp	70
Service Vehicle Soon Light	71
Brake and Clutch System Warning Light	71
Antilock Brake System (ABS) Warning Light	71
Gear Shifting Light	71
Variable Effort Steering Light	72
Lane Departure Warning (LDW) Light	72
Ultrasonic Parking Sensor Light	72
Electronic Stability Control (ESC) Indicator Light	72
Electronic Stability Control (ESC) Off Light	72
Traction Control System (TCS) Off Light	72
Engine Coolant Temperature Warning Light	73
Tyre Pressure Monitoring System Light	73
Engine Oil Pressure Light	73
Low Fuel Warning Light	74
Auto Stop Mode	74
Immobiliser Light	74
Reduced Engine Power Light	74

Main-Beam On Light	74
Front Fog Lamp Light	74
Rear Fog Lamp Light	74
Tail lamp Indicator Light	74
Cruise Control Light	74
Bonnet Ajar Light	74
Door Ajar Light	74

### Information Displays

Driver Information Centre (DIC)	75
---------------------------------	----

### Vehicle Messages

Vehicle Messages	80
Warning Buzzers	81

### Vehicle Personalisation

Vehicle Personalisation	82
-------------------------	----

## 60 Instruments and Controls

### Controls

#### Steering Wheel Adjustment



Unlock lever, adjust steering wheel, then engage lever and ensure it is fully locked.

Do not adjust steering wheel unless vehicle is stationary and steering wheel lock has been released.

#### Steering Wheel Controls





The Infotainment system, the cruise control and a connected mobile phone can be operated via the controls on the steering wheel.

Further information is available in the Infotainment system manual.

Cruise control ⇨ *Cruise Control* ⇨ 152.

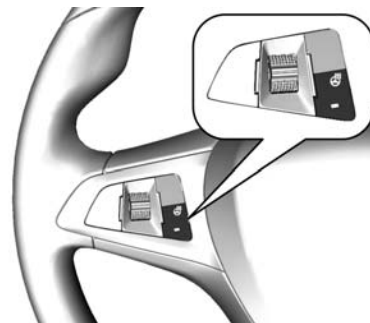
#### Heated Steering Wheel



Activate heating by pressing . Activation is indicated by the LED in the button.



The grip areas of the steering wheel are heated quicker and to a higher temperature than the other areas.

Heating is operational when the engine is running and during an Autostop.

Stop-start system ⇨ *Automatic Engine Start/Stop Feature* ⇨ 141.

## Horn



Press .

## Windscreen Wiper/Washer

### Windscreen wiper

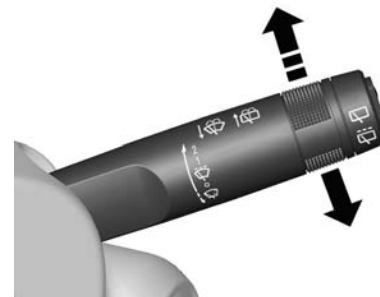

**2** : Continuous wipe, fast speed. off.

**1** : Continuous wipe, slow speed.

 : Intermittent operation.

**○** : System off.

For a single wipe when the Windscreen wiper is off, press the lever down to position 1x.

Do not use if the Windscreen is frozen. Switch off in car washes.

## 62 Instruments and Controls

### Windscreen washer

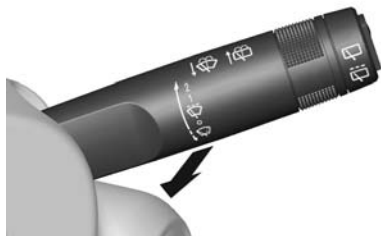

Pull lever. Washer fluid is sprayed onto the Windscreen and the wiper wipes a few times.

### Rear Window Wiper/ Washer



Press the rocker switch to activate the rear window wiper:

Upper position: Short interval

Lower position: Long interval

Middle position: Off

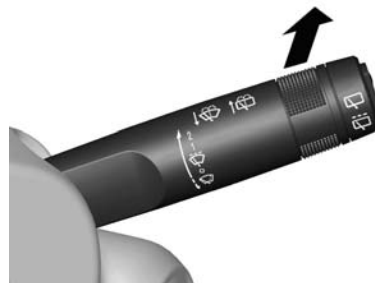

Push lever. Washer fluid is sprayed onto the rear window and the wiper wipes a few times.

Do not use if the Windscreen is frozen. Switch off in car washes.

The rear window wiper comes on automatically when the Windscreen wiper is switched on and reverse gear is engaged.

Activation or deactivation of this function can be changed in the menu Settings in the Info-Display.

Vehicle personalisation ⇨ *Vehicle Personalisation* ⇨ 82.

## Outside Temperature



The outside temperature is shown in the infotainment display.

Driver Information Centre (DIC) ⇨  
*Driver Information Centre (DIC)* ⇨ 75.

## Clock



Time and date are shown in the infotainment display.

Personalisation ⇨  
*Personalisation* ⇨ 115.

## Power Sockets



A 12 Volt power socket is located in the centre console.

Do not exceed the maximum power consumption of 120 watts.

With ignition off, the power socket is deactivated. Additionally the power socket is deactivated in the event of low vehicle battery voltage.

Electrical accessories that are connected must comply with the electromagnetic compatibility requirements laid down in DIN VDE 40 839.



## 64 Instruments and Controls

Do not connect any current-delivering accessories, e.g. electrical charging devices or batteries.

Do not damage the outlet by using unsuitable plugs.

Stop-start system ⇨ *Automatic Engine Start/Stop Feature* ⇨ 141.

### Warning Lights, Gauges, and Indicators

#### Speedometer

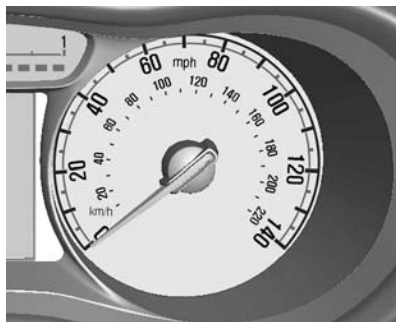

Indicates vehicle speed.

#### Mileometer



The bottom line displays the recorded distance in miles.

#### Trip Odometer

The top line displays the recorded distance since the last reset.

To reset, press **SET/CLR** on the indicator lever for a few seconds ⇨ *Driver Information Centre (DIC)* ⇨ 75.

## Rev Counter

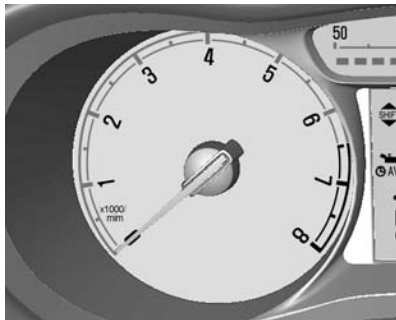

Displays the engine speed.  
Drive in a low engine speed range for each gear as much as possible.

### Caution

If the needle is in the red warning zone, the maximum permitted engine speed is exceeded.  
Engine at risk.

## Fuel Gauge

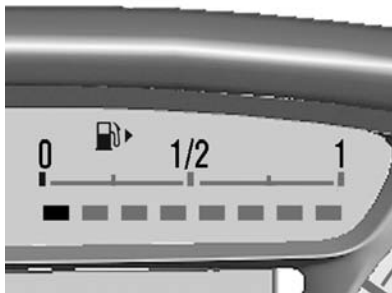

Displays the fuel level.

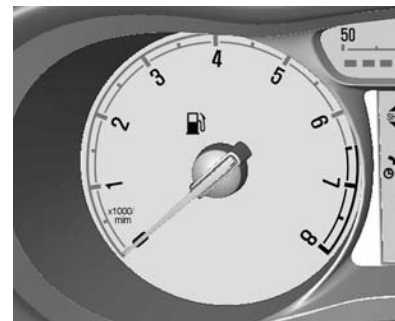

Control indicator  illuminates if the level in the tank is low. Refuel immediately if it flashes.

Because of the fuel remaining in the tank, the top-up quantity may be less than the specified tank capacity.

Never run the tank dry.

## 66 Instruments and Controls

---

### Control Indicators

The control indicators described are not present in all vehicles. The description applies to all instrument versions.

Depending on the equipment the position of the control indicators may vary.

When the ignition is switched on, most control indicators will illuminate briefly as a functionality test.

The control indicator colours mean:

Red: Danger, important reminder

Yellow: Warning, information, fault

Green: Confirmation of activation

Blue: Confirmation of activation

White: Confirmation of activation

### Control indicators in the instrument cluster



## 68 Instruments and Controls

### Control indicators in the centre



### Engine Coolant Temperature Gauge

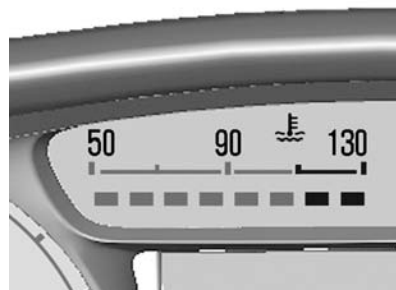

Displays the coolant temperature.

Left area: Engine operating temperature not yet reached

Central area: Normal operating temperature

Right area: Temperature too high

### Caution

If engine coolant temperature is too high, stop vehicle, switch off engine. Danger to engine. Check coolant level.

### Service Display

The engine oil life system lets you know when to change the engine oil and filter. Based on driving conditions, the interval at which an engine oil and filter change will be indicated can vary considerably.



The menu and function can be selected via the buttons on the indicator lever.

To display the remaining engine oil life duration:



Press **MENU** to select the Vehicle Information Menu.

Turn the adjuster wheel to select Remaining Oil Life.

The system must be reset every time the engine oil is changed to allow proper functionality. Seek the assistance of a workshop.

Press **SET/CLR** to reset. The ignition must be switched on, with the engine not running.

When the system has calculated that engine oil life has been diminished, Change Engine Oil Soon or a warning code appears in the Driver Information Centre. Have engine oil and filter changed by a workshop within one week or 300 miles (whichever occurs first).

Driver Information Centre ⇨ *Driver Information Centre (DIC)* ⇨ 75.

Service information ⇨ *Service Information* ⇨ 198.

## Indicator

⇨⇨ illuminates or flashes green.

### Illuminates briefly

The parking lights are switched on.

### Flashes

An indicator or the hazard warning lights are activated.

Rapid flashing: failure of an indicator light or associated fuse, failure of indicator light on trailer.

Bulb replacement ⇨ *Bulb Replacement* ⇨ 167.

Fuses ⇨ *Fuses* ⇨ 173.

Indicators ⇨ *Indicator Signals* ⇨ 86.

## Seat Belt Reminders

### Seat belt reminder on front seats

 illuminates or flashes red.

### Illuminates

After the ignition has been switched on until the seat belt has been fastened.

### Flashes

After having started the engine for a maximum of 100 seconds until the seat belt has been fastened.

Fastening the seat belt ⇨ *Three-Point Seat belt* ⇨ 36.

### Seat belt status on rear seats

 in the Driver Information Centre flashes or illuminates.

## 70 Instruments and Controls

### Flashes

After starting off when the seat belt is unfastened.

Fastening the seat belt ⇨  
*Three-Point Seat belt* ⇨ 36.

### Airbag and Safety Belt Tensioner Light

 illuminates red.

When the ignition is switched on, the control indicator illuminates for a few seconds. If it does not illuminate, does not go out after few seconds or illuminates whilst driving, there is a fault in the airbag system. Seek the assistance of a workshop. The airbags and belt pretensioners may fail to trigger in the event of an accident.

Deployment of the belt pretensioners or airbags is indicated by continuous illumination of .

### Warning

Have the cause of the fault remedied immediately by a workshop.

Seat belts, airbag system ⇨ *Seat belts* ⇨ 35, *Airbag System* ⇨ 38.

### Airbag On-Off Light

<sub>2</sub> illuminates yellow.

Illuminates for a few seconds after the ignition is switched on. The front passenger airbag is activated.

<sub>2</sub> illuminates yellow.

The front passenger airbag is deactivated ⇨ *Airbag On-Off Switch* ⇨ 43.

### Danger

Risk of fatal injury for a child using a child restraint system together with activated front passenger airbag. Risk of fatal  
(Continued)

### Danger (Continued)

injury for an adult person with deactivated front passenger airbag.

### Charging System Light

 illuminates red.

Illuminates when the ignition is switched on and extinguishes shortly after the engine starts.

#### Illuminates when the engine is running

Stop, switch off engine. Vehicle battery is not charging. Engine cooling may be interrupted. The brake servo unit may cease to be effective. Seek the assistance of a workshop.

### Malfunction Indicator Lamp

 illuminates or flashes yellow.

Illuminates when the ignition is switched on and extinguishes shortly after the engine starts.

### Illuminates when the engine is running

Fault in the emission control system. The permitted emission limits may be exceeded. Seek the assistance of a workshop immediately.

### Flashes when the engine is running

Fault that could lead to catalytic converter damage. Ease up on the accelerator until the flashing stops. Seek the assistance of a workshop immediately.

## Service Vehicle Soon Light

 illuminates yellow.

Additionally a warning code is displayed.

The vehicle needs a service.

Seek the assistance of a workshop.

Vehicle messages ⇨ *Vehicle Messages* ⇨ 80.

## Brake and Clutch System Warning Light

 illuminates red.

The brake and clutch fluid level is too low ⇨ *Brake Fluid* ⇨ 164.

### Warning

Stop. Do not continue your journey. Consult a workshop.

### Operate pedal

 illuminates or flashes yellow.

Clutch pedal needs to be depressed to start the engine in Autostop mode.

Stop-start system ⇨ *Automatic Engine Start/Stop Feature* ⇨ 141.

### Flashes

Clutch pedal needs to be depressed for a main start of the engine ⇨ *Automatic Engine Start/Stop Feature* ⇨ 141, ⇨ *New Vehicle Run-In* ⇨ 139.

## Antilock Brake System (ABS) Warning Light



 illuminates yellow.

Illuminates for a few seconds after the ignition is switched on. The system is ready for operation when the control indicator extinguishes.

If the control indicator does not go out after a few seconds, or if it illuminates while driving, there is a fault in the ABS. The brake system remains operational but without ABS regulation.

Anti-lock brake system ⇨ *Antilock Brake System (ABS)* ⇨ 146.

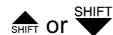
## Gear Shifting Light

 or  with the number of the next higher or lower gear is indicated, when upshifting or downshifting is recommended for fuel saving reasons.



## 72 Instruments and Controls

### Variable Effort Steering Light

 illuminates yellow.

Fault in Electric Power Steering (EPS) system. This may lead to a higher or lower steering effort. Consult a workshop.

Stop-start system ⇨ *Automatic Engine Start/Stop Feature* ⇨ 141.

### Lane Departure Warning (LDW) Light

 illuminates green or flashes yellow.

#### Illuminates green

The system is switched on and ready to operate.

#### Flashes yellow

The system recognises an unintended lane change.

### Ultrasonic Parking Sensor Light

 illuminates yellow.

Fault in system

or

Fault due to sensors that are dirty or covered by ice or snow

or

Interference due to external sources of ultrasound. Once the source of interference is removed, the system will operate normally.

Have the cause of the fault in the system remedied by a workshop.

Ultrasonic parking assist ⇨ *Parking Assist (Rear parking assist)* ⇨ 150.

### Electronic Stability Control (ESC) Indicator Light

 illuminates or flashes yellow.

#### Illuminated

A fault in the system is present.

Continued driving is possible. Driving stability, however, may deteriorate depending on road surface conditions.

Have the cause of the fault remedied by a workshop.

#### Flashes

The system is actively engaged.

Engine output may be reduced and the vehicle may be braked automatically to a small degree.

### Electronic Stability Control (ESC) Off Light

 illuminates yellow.

The system is deactivated.

### Traction Control System (TCS) Off Light

 illuminates yellow.

The system is deactivated.

## Engine Coolant Temperature Warning Light

 illuminates red.

This light tells you that the engine coolant has overheated.

If you have been operating your vehicle under normal driving conditions, you should pull off the road, stop your vehicle and let the engine idle for a few minutes.

If the light does not go out, you should switch the engine off and consult a workshop as soon as possible. We recommend that you consult your authorised workshop.

## Tyre Pressure Monitoring System Light

 illuminates or flashes yellow.

### Illuminates

Tyre pressure loss. Stop immediately and check tyre pressure.

## Flashes

Fault in system or tyre without pressure sensor mounted (e.g. spare wheel). After 60-90 seconds the control indicator illuminates continuously. Consult a workshop.

Tyre pressure monitoring system   
*Tyre Pressure*  179.

## Engine Oil Pressure Light

 illuminates red.

Illuminates when the ignition is switched on and extinguishes shortly after the engine starts.

### Illuminates when the engine is running

#### Caution

Engine lubrication may be interrupted. This may result in damage to the engine and/or locking of the drive wheels.



If the engine oil pressure warning light comes on while driving, Pull off the road, stop the engine and check the oil level.

1. Depress clutch.
2. Select neutral gear, set selector lever to N.
3. Move out of the flow of traffic as quickly as possible without impeding other vehicles.
4. Switch off ignition.

#### Warning

When the engine is off, considerably more force is needed to brake and steer. Autostop the brake servo unit will still be operational.

Do not remove key until vehicle is stationary, otherwise the steering wheel lock could engage unexpectedly.

Check oil level before seeking assistance of a workshop  *Engine Oil*  162.

## 74 Instruments and Controls

### Low Fuel Warning Light

 illuminates or flashes yellow.

#### Illuminates

Level in fuel tank is too low.

#### Flashes

Fuel used up. Refuel immediately.  
Never run the tank dry.

Catalytic converter ⇨ *Catalytic Converter* ⇨ 144.

### Auto Stop Mode

 illuminates when engine is in an Autostop.

Stop-start system ⇨ *Starting the Engine* ⇨ 140.

### Immobiliser Light

 flashes yellow.

Fault in the immobiliser system. The engine cannot be started.

### Reduced Engine Power Light

 illuminates yellow.

The engine power is limited. Consult a workshop.

### Main-Beam On Light

 illuminates blue.

Illuminated when main beam is on and during headlight flash ⇨ *Exterior Lamp Controls* ⇨ 85.

### Front Fog Lamp Light

 illuminates green.

The front fog lights are on ⇨ *Front Fog Lamps* ⇨ 87.

### Rear Fog Lamp Light

 illuminates yellow.

The rear fog light is on ⇨ *Rear Fog Lamps* ⇨ 87.

### Tail lamp Indicator Light

 illuminates green.

The exterior lights are on ⇨ *Exterior Lamp Controls* ⇨ 85.

### Cruise Control Light

 illuminates white or green.

#### Illuminates white

The system is on.

#### Illuminates green

A certain speed is stored.

Cruise control ⇨ *Cruise Control* ⇨ 152.

### Bonnet Ajar Light

 illuminates when the bonnet is open.

Automatic engine stop/start feature ⇨ *Automatic Engine Start/Stop Feature* ⇨ 141.

### Door Ajar Light

 illuminates red.

A door or the tailgate is open.

## Information Displays

### Driver Information Centre (DIC)

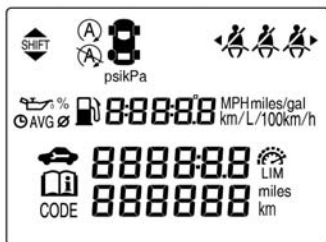

The Driver Information Centre (DIC) is located in the instrument cluster.

The menu pages are selected by pressing **MENU** on the indicator lever.

Selectable menu pages of Mid-level display are:

- trip menu, see below
- vehicle menu, see below

Some of the displayed functions differ when the vehicle is being driven or at a standstill. Some functions are only available when the vehicle is being driven.

#### Selecting menus and functions

The menus and functions can be selected via the buttons on the indicator lever.



Press **MENU** to switch between the menus or to return from a sub-menu to the next higher menu level.



Turn the adjuster wheel to highlight a menu option or to set a numeric value.



## 76 Instruments and Controls

Press **SET/CLR** to select a function or to confirm a message.

### Trip Menu

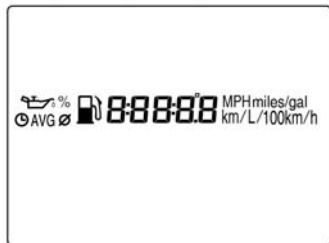

Trip computer is located in Driver Information Centre (DIC).

It provides the driver with driving information such as average speed, driving distance for remaining fuel, average consumption and driving time.



To operate the trip computer, turn the adjuster wheel in indicator lever.

Each time you turn the adjuster wheel, the mode changes in the following order:

Trip Odometer—> Total Fuel Range  
—> Average Vehicle Speed—>  
Instantaneous Fuel Economy—>  
Average Fuel Economy—> Timer

Some modes can be reset by pressing **SET/CLR**.

### Average speed

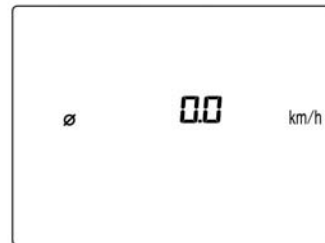

This mode indicates the average speed.

The average speed is accumulated while the engine is running even the vehicle is not driven.

To reset the average speed, press **SET/CLR**.

### Driving distance for remaining fuel

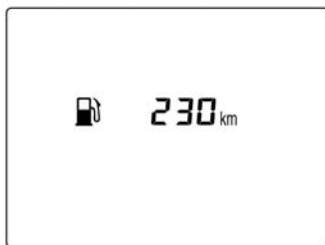

This mode indicates the estimated driving distance to empty from the current fuel in the fuel tank.

If you fill the fuel when the vehicle is in inclined situations or a battery is disconnected, trip computer cannot read the actual value.

**Note:** As an auxiliary device, the trip computer may have differences with the actual distance for remaining fuel according to circumstances.

The driving distance for remaining fuel can be changed by the driver, the road, and the vehicle speed because it is calculated according to the changing fuel efficiency.

### Average consumption

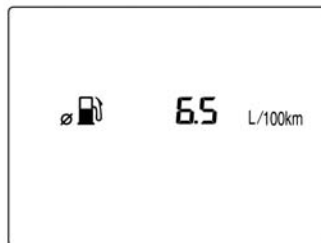

This mode indicates the average consumption.

The average consumption is accumulated while the engine is running even the vehicle is not driven.

### Driving time



This mode indicates the total driving time.

The driving time is accumulated since the last driving time reset even when the vehicle is not driven.

To stop or start the driving time, press **SET/CLR**.

To reset the driving time, press **SET/CLR** for a few seconds.

**Note:** The average speed, driving distance for remaining fuel, average consumption can differ from the

## 78 Instruments and Controls

actual distance according to driving conditions, driving pattern or vehicle speed.

### Trip odometer



Trip odometer displays the recorded distance since a certain reset.

To reset, press **SET/CLR** for a few seconds.

### Instantaneous fuel economy

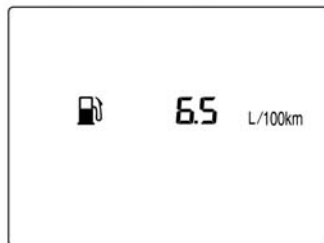

Display of the instantaneous consumption.

### Vehicle menu

You can select the following order:

- engine oil life
- unit setting
- tyre learn
- tyre loading
- language set

Each menu can be selected turn the adjuster wheel in the indicator lever.

### Engine oil life



It displays an estimate of the oil's remaining useful life.

If the number 98 is displayed, it means 98% of the current oil life remains.

When the remaining oil life is low, the vehicle message will appear in the Driver Information Centre (DIC). The engine oil should be changed as soon as possible.

After engine oil change, the engine oil life system must be reset. To reset, press **SET/CLR** a few seconds.

Engine oil on ⇨ *Engine Oil* ⇨ 162.

### Unit setting

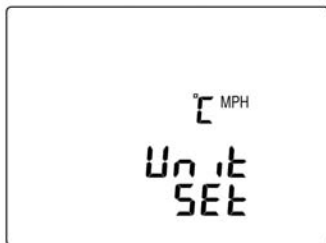

Press **SET/CLR** a few seconds.  
Turn the adjuster wheel to select one of the settings.

1. metric (km/h, °C)
2. imperial (MPH, °C)
3. us (MPH, °F)

During change unit, selected unit is flashed.

Press **SET/CLR** to confirm.

### Tyre learn

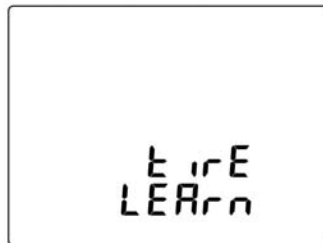

This display allows for matching new tyre and wheel by the TPMS sensors.

To process matching, press **SET/CLR** a few seconds.

See Tyre pressure monitoring system light ⇨ *Tyre Pressure Monitoring System Light* ⇨ 73.

### Tyre loading



Press **SET/CLR** a few seconds to select the menu.

Turn the adjuster wheel to select one of the settings.

- load Lo
- load Eco
- load Hi



## 80 Instruments and Controls

### Vehicle Messages

Messages are indicated mainly in the Driver Information Centre (DIC), in some cases together with a warning and signal buzzer.

Press **SET/CLR, MENU** or turn the adjuster wheel to confirm a message.



The vehicle messages are displayed as code numbers.

No. Vehicle message

- 2 No remote detected, Press clutch to restart
- 3 Coolant level low add coolant

- 4 A/C Off due to high engine temp
- 5 Steering column is locked
- 6 Step on brake to release park brake
- 7 Turn steering wheel, Turn key Off, Then On
- 8 Turn key Off, Then On – repeat breath test
- 9 Turn steering wheel, Start vehicle again
- 11 Brakes worn
- 12 Vehicle overloaded
- 13 Compressor overheated
- 15 Check high mounted brake lamp
- 16 Check brake lamps
- 17 Headlight levelling malfunction
- 18 Left dipped beam failure
- 19 Check rear fog lamp
- 20 Check right dipped beam lamp
- 21 Check left position lamp
- 22 Check right position lamp
- 23 Reversing light failure
- 24 Number plate light failure
- 25 Check left front indicator lamp
- 26 Left rear turn indicator failure
- 27 Check right front indicator lamp
- 28 Check right rear indicator lamp
- 29 Check trailer brake lamp
- 30 Check trailer reversing lamp
- 31 Check left trailer indicator lamp
- 32 Check right trailer indicator lamp
- 33 Check trailer rear fog lamp
- 34 Check trailer rear lamp
- 35 Replace Battery In Remote Key
- 36 Stabilitrak Initialising
- 38 Take steering (text approval still pending)
- 48 Side detection system unavailable
- 49 Lane departure warning unavailable
- 50 Reset bonnet – see owners manual
- 52 Change timing belt
- 53 Tighten fuel cap / Electric vehicles

56 Pressure imbalance – front  
57 Pressure imbalance – rear  
58 Winter tyre detected  
59 Open, then close driver window  
60 Open, then close passenger window  
61 Open, then close left rear window  
62 Open, then close right rear window  
63 Open, then close midgate window  
64 Open, then close endgate window (placeholder only)  
65 Theft attempted  
66 Service theft alarm  
67 Service steering column lock  
68 Service power steering, Drive with care  
70 Service levelling system  
75 Service AC system  
76 Service side detection system

77 Service lane departure warning / Service front camera  
78 Service pedestrian protection  
79 Engine oil low – add oil  
81 Service transmission  
82 Change engine oil soon  
84 Engine power is reduced  
89 Service vehicle soon  
91 No remote detected  
92 No remote detected, Press brake to restart  
93 Press button again to turn engine Off / Electric vehicles  
94 Shift to park  
95 Service airbag  
96 Power sliding door unavailable  
98 Power tailgate unavailable / Power tailgate switch is Off  
99 Pedestrian protection system disabled  
120 Reduce speed for hill decent control

145 Washer fluid low – add fluid  
151 Press clutch to start  
173 All wheel drive Off  
174 Low battery  
258 Park assist Off

### Warning Buzzers

Only one warning chime will sound at a time.

The warning chime regarding unfastened seat belts has priority over any other warning chime.

### When starting the engine or whilst driving

- If seat belt is not fastened.
- If a door or the tailgate is not fully closed when starting-off.
- If a certain speed is exceeded with parking brake applied.
- If a programmed speed is exceeded.

## 82 Instruments and Controls

- If a warning message or a warning code appears in the Driver Information Centre.
- If the parking assist detects an object.
- If reverse gear is engaged and the rear end carrier is extended.
- If a fault in the automatic locking system is detected.

### When the vehicle is parked and / or the driver's door is opened

- With exterior lights on.

### During an Autostop

- If the driver's door is opened.

### Battery voltage

When the vehicle battery voltage is running low, a warning message or warning code 174 will appear in the Driver Information Centre.

1. Switch off immediately any electrical consumers which are not required for a safe ride, e.g. seat heating, heated rear window or other main consumers.
2. Charge the vehicle battery by driving continuously for a while or by using a charging device.

The warning message or warning code will disappear after the engine has been started twice consecutively without a voltage drop.

If the vehicle battery cannot be recharged, have the cause of the fault remedied by a workshop.

## Vehicle Personalisation

The vehicle can be personalised by changing the settings in the infotainment display.

Depending on vehicle equipment some of the functions described below might not be available.



Press **MENU**, when ignition is ON and infotainment system is activated.

Setting menus displayed.

To switch the Settings menu turn the MENU knob.

To select the Settings menu, press **MENU**.

To close or back to previous, press **BACK**.

Select the "Vehicle settings".

### Vehicle Settings

- Park assist / Collision detection

Park assist: Activate or deactivate the ultrasonic sensors.

- Comfort settings

Chime volume: Change the volume of warning chime.

Personalisation by driver: Activate or deactivate the personalisation.

Rear auto wipe in reverse: Activate or deactivate the rear wipe in reverse gear.

- Language

Select the Language menu item.

Scroll through the list and select the desired language.

- Exterior ambient lighting

Exterior lighting by unlocking: Activate or deactivate the entry lighting.

Duration upon exit of vehicle: Activate or deactivate of exit lighting and change the lighting duration.

Stop door lock if door open: Activate or deactivate the driver's door lock when the door is open.

If deactivated is selected, the Delayed door lock menu is available.

Delayed door lock: Activate or deactivate the delayed door lock.

When pressing the central locking button, three chimes are sounds to signal delayed locking is in use. This function will delay the locking of the doors until five seconds after the last door is closed.

- Remote locking, unlocking, starting

Remote unlock feedback: Activate or deactivate the light feedback while unlocking.

Remote door unlock: Change the configuration to unlock only the driver's door or the all doors while unlocking.

Auto relock doors: Activate or deactivate the door automatically locking when door is not opened after unlocking.

- Restore factory settings

All settings are restored to initial settings.

- Valet mode

if valet mode is activated, all vehicle displays are locked and no changes may be performed within the system.

**Note:** Vehicle-related messages remain enabled.

## 84 Instruments and Controls

---

Locking the system: Press **MENU** and then select the **SETTINGS** Menu.

Scroll through the list and select the Valet Mode menu item.

Enter a four-digit code and select the **ENTER**.

To confirm the first input, re-enter the four-digit code and select the **LOCK**. The system is locked.

Unlocking the system: Turn the Infotainment system on.

Enter the respective four-digit code and select the **UNLOCK**. The system is unlocked.

Forgotten PIN code: To reset the PIN code to the default setting, contact your Opel Service Partner.

## Lighting

### Exterior Lighting

Exterior Lamp Controls	85
Headlamp Main/Dipped-Beam Changer	85
Headlamp Range Adjustment	86
Daytime Running Lamps (DRL)	86
Hazard Lights	86
Turn and Lane-Change Signals	86
Front Fog Lamps	87
Rear Fog Lamps	87
Cornering Lights	87
Position Lamps	88
Reversing Lamps	88
Misted Lamp Covers	88

### Interior Lighting

Instrument Panel Illumination Control	88
Interior Lamps	89

### Lighting Features

Centre Console Lighting	90
Entry Lighting	90
Exit Lighting	90
Battery Power Protection	91

## Exterior Lighting

### Exterior Lamp Controls

#### Light Switch



Turn light switch:

O : Lights off

☉☉ : Sidelights

☉☉☉ : Dipped beam

Control indicator ☉☉☉ ⇨ Tail light  
Indicator Light ⇨ 74.

When dipped beam is on, ☉☉☉  
illuminates. Control indicator ☉☉☉ ⇨  
Tail light Indicator Light ⇨ 74.

### Tail lights

Tail lights are illuminated together  
with dipped beam and sidelights.

### Headlamp Main/ Dipped-Beam Changer

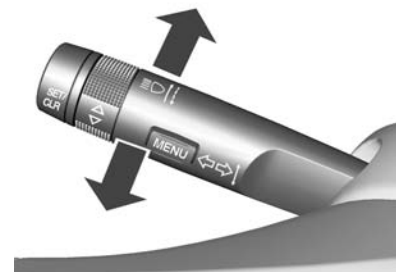

To switch from low to main beam,  
push lever.

To switch to dipped beam, push  
lever again or pull.

### Headlight flash

To activate the headlight flash, pull  
lever.

## 86 Lighting

### Headlamp Range Adjustment

#### Manual headlight range adjustment



To adapt headlight range to the vehicle load to prevent dazzling: turn thumb wheel  to required position.

0 : Front seats occupied

1 : All seats occupied

2 : All seats occupied and load compartment laden

3 : Driver's seat occupied and load compartment laden

### Daytime Running Lamps (DRL)

Daytime running light increases visibility of the vehicle during daylight.

They are switched on automatically when ignition is on.

### Hazard Lights



Operated with .

In the event of an accident with airbag deployment the hazard warning flashers are activated automatically.

### Turn and Lane-Change Signals



Lever up : Right indicator

Lever down : Left indicator

If the lever is moved past the resistance point, the indicator is switched on constantly. When the steering wheel moves back, the indicator is automatically deactivated.

For three flashes, e.g. when changing lanes, press the lever until resistance is felt and then release.

Move the lever to the resistance point and hold for longer indication.

Switch the indicator off manually by moving the lever to its original position.

## Front Fog Lamps



Operated with .

## Rear Fog Lamps



Operated with .

Light switch in position : Rear fog light can only be switched on with front fog lights.

## Cornering Lights

### Corner lighting



On tight bends or when turning off, depending on the steering angle or the indicator light signal, an additional left or right reflector is switched on which illuminates the road in the direction of travel. It is activated up to a speed of 25 mph.



## 88 Lighting

### Position Lamps



When the vehicle is parked, the parking lights on one side can be activated:

1. Switch off ignition.
2. Move indicator lever all the way up (right parking lights) or down (left parking lights).

Confirmed by a signal and the corresponding indicator control indicator.

### Reversing Lamps

The reversing light comes on when the ignition is on and reverse gear is selected.

### Misted Lamp Covers

The inside of the light housing may mist up briefly in poor, wet and cold weather conditions, in heavy rain or after washing. The mist disappears quickly by itself; to help switch on the exterior lights.

### Interior Lighting

#### Instrument Panel Illumination Control



Brightness of the following lights can be adjusted when the exterior lights are on :

- instrument panel illumination
- info-Display
- illuminated switches and operation elements

Turn thumb wheel  until the required brightness is obtained.

On vehicles with light sensor the brightness can only be adjusted when the exterior lights are on and the light sensor detects night conditions.

## Interior Lamps

During entry and exit of the vehicle, the front courtesy lights automatically switch on and then off after a delay.

**Note:** In the event of an accident with airbag deployment the courtesy lights are turned on automatically.

### Front courtesy light



Operate rocker switch :

 : Automatic switching on and off.

press  : On.

press  : Off.

### Reading lamps



Operated with buttons in front courtesy lights.

## 90 Lighting

### Lighting Features

#### Centre Console Lighting

Spotlight incorporated in the interior lighting comes on when the dipped beam is switched on.

#### Entry Lighting

##### Welcome lighting

The exterior lights, instrument panel light and interior lights are switched on for a short time by pressing the unlocking button  on the radio remote control twice. This function works only in the dark and facilitates locating the vehicle.

The lighting switches off immediately when the ignition key is turned to position 1  $\Rightarrow$  *Ignition Positions*  $\Rightarrow$  139.

Activation or deactivation of this function can be changed in the menu **Settings** in the Info-Display. Vehicle personalisation  $\Rightarrow$  *Vehicle Personalisation*  $\Rightarrow$  82.

The settings can be saved for the key being used  $\Rightarrow$  *Memorised Settings*  $\Rightarrow$  20.

The following lights will additionally switch on when the driver's door is opened :

- all switches
- driver Information Centre

#### Exit Lighting

The following lights illuminate if the key is removed from the ignition switch :

- Interior lights
- Instrument panel light (only when it is dark)

They will switch off automatically after a delay. Both lights will be activated again if the driver's door is opened.

The exterior lights illuminate the surrounding area for an adjustable time after leaving the vehicle.

#### Switching on



1. Switch off ignition.
2. Remove ignition key.
3. Open driver's door.
4. Pull indicator lever.
5. Close driver's door.

If the driver's door is not closed the lights switch off after 2 minutes.

Exit lighting is switched off immediately if the indicator lever is pulled while the driver's door is open.

Activation, deactivation and duration of this function can be changed in the menu Settings in the Info-Display. Vehicle personalisation ⇨ *Vehicle Personalisation* ⇨ 82.

The settings can be saved for the key being used ⇨ *Memorised Settings* ⇨ 20.

## **Battery Power Protection**

### **Switching off electric lights**

To prevent discharge of the vehicle battery when the ignition is switched off, some interior lights are switched off automatically after some time.

## 92 Infotainment System

# Infotainment System

### Introduction

Introduction .....	92
Theft-Deterrent Feature .....	92
Overview .....	93
Operation .....	99

### Radio

AM-FM Radio .....	102
Radio Data System (RDS) ....	106

### Audio Players

Auxiliary Devices .....	108
-------------------------	-----

### Personalisation

Personalisation .....	115
-----------------------	-----

### Phone

Bluetooth ((Type A/B only)) ...	116
---------------------------------	-----

### OnStar System

OnStar System .....	125
---------------------	-----

## Introduction

### General

The Infotainment system provides Infotainment in your car, using the latest technology.

The radio can be easily used by registering up to 24 AM-FM radio or DAB stations with the – (preset) buttons 1 ~ 4 per every six pages.

The USB player can play connected USB storage devices or iPod products.

The function of the Bluetooth phone connection allows for the use of wireless hands-free phone calls, as well as a phone music player.

Connect a portable music player to the exterior sound input and enjoy the rich sound of the Infotainment system.

The digital sound processor provides a number of preset equaliser modes for sound optimisation.

## Specifications

- Maximum output power : 25 W x 4 channels
- Speaker impedance : 4 ohms

The system can be easily adjusted using the carefully designed adjusting device, smart display, and multifunctional menu dial regulator.

- The "**Overview**" section provides a simple overview of the Infotainment system functions and a summary of all regulatory devices.
- The "**Operation**" section explains the basic controls for the Infotainment system.

## Theft-Deterrent Feature

The Infotainment system is equipped with an electronic security system for the purpose of theft deterrence.

The Infotainment system therefore functions only in your vehicle and is worthless to a thief.

## Overview

### Control panel R300 BT

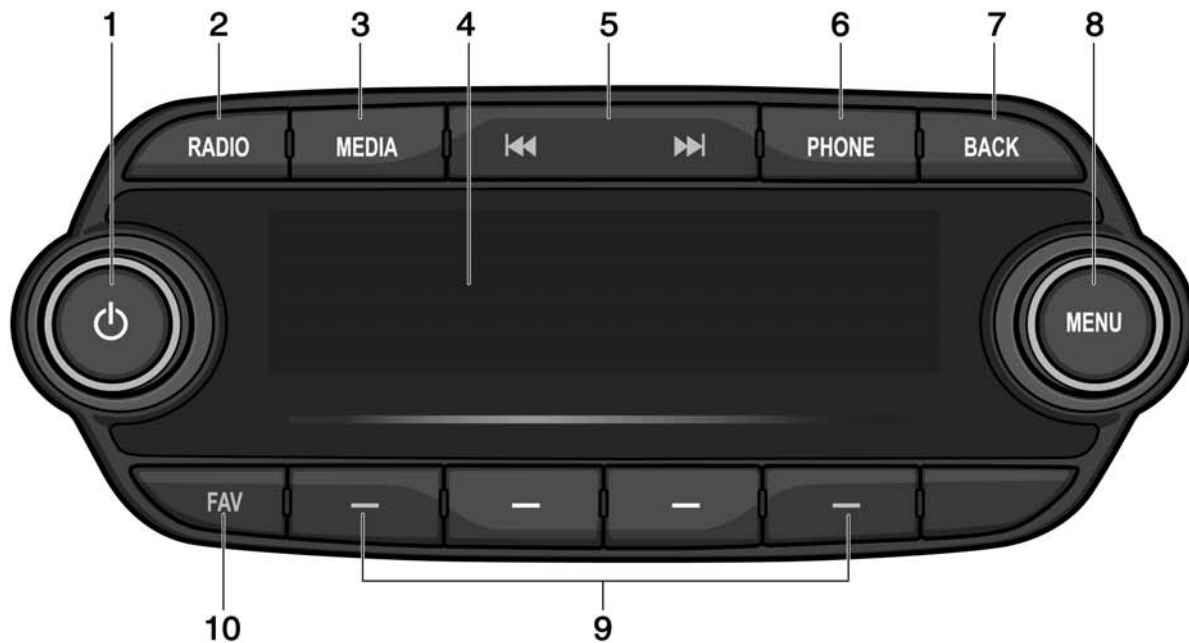

## 94 Infotainment System

1.  (power) button with VOLUME dial
  - When power is off, press to turn power on.
  - When power is on, press and hold to turn power off.
  - When power is on, press shortly to turn the mute function on or off.
  - Turn to control volume.
2. RADIO

Select Radio mode. Each time the button is pressed, the system switches between AM RADIO → FM RADIO → DAB → AM RADIO → ....
3. MEDIA

Press the button to change the mode in the order of USB/iPod → AUX → Bluetooth music → USB/iPod → ....
4. Display

Display for Play, Reception, Menu state and information.
5.  (seek)
  - In Radio or DAB mode:  
When pressed shortly, automatically seeks station with superior reception.  
When pressed and held, continuously changes the station until the button is released. When releasing, the system stops on the current frequency displayed or seeks the next station.
  - In USB/iPod/Bluetooth audio playback:  
When pressed shortly, move to the previous or next file.  
When pressed and held, rewind or fast forward the file.
6. PHONE

Press this button to enter the phone application mode.
7. BACK

Cancel input content or return to the previous menu.
8. MENU button with TUNE dial
  - Turn dial to search the station/file on the list screen or move/change setup content or setup values.
  - Press the button to display the currently functioning menu or select/practice setup content and setup values.

9. - (preset) buttons

- In Radio mode:

When pressed shortly,  
recall the stored radio  
station.

When pressed and held,  
store the current radio  
station to the  
Favourites page.

- In Menu mode:

Press any of these buttons  
to select the function linked  
to that button.

10. FAV (favourites)



Press this button to select the  
page of saved favourite  
channels.

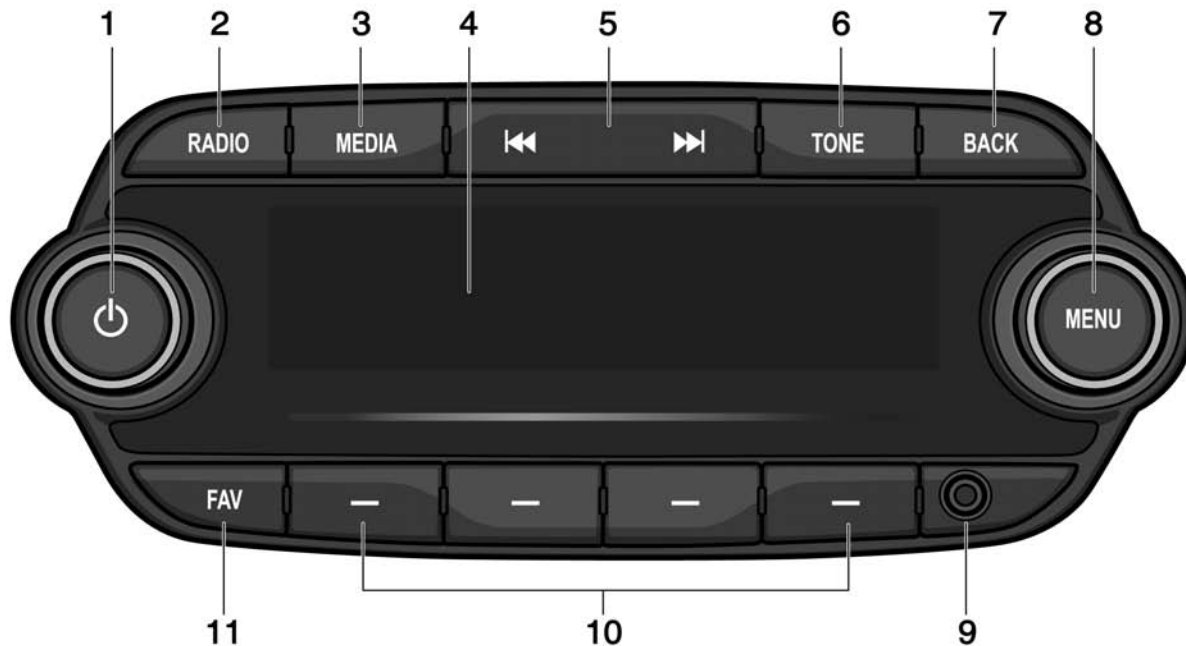

## 96 Infotainment System

### Control panel R300



1.  (power) button with VOLUME dial
  - When power is off, press to turn power on.
  - When power is on, press and hold to turn power off.
  - When power is on, press shortly to turn the mute function on or off.
  - Turn to control volume.
2. RADIO  
Select Radio mode. Each time the button is pressed, the system switches between AM RADIO → FM RADIO → AM RADIO → ....
3. MEDIA  
Press the button to enter the Aux mode.
4. Display  
Display for Play, Reception, Menu state and information.
5.  (seek)  
When pressed shortly, automatically seeks station with superior reception.  
When pressed and held, continuously changes the station until the button is released. When releasing, the system stops on the current frequency displayed or seeks the next station.
6. TONE  
Press this button to enter the Tone Settings mode.
7. BACK  
Cancel input content or return to the previous menu.
8. MENU button with TUNE dial
  - Turn dial to search the station on the list screen or move/change setup content or setup values.
9. AUX port  
Connect the external audio device.
10. - (preset) buttons
  - In Radio mode:  
When pressed shortly, recall the stored radio station.  
When pressed and held, store the current radio station to the Favourites page.
  - In Menu mode:  
Press any of these buttons to select the function linked to that button.
11. FAV (favourites)  
Press this button to select the page of saved favourite channels.

## 98 Infotainment System

### Steering wheel audio remote control: option

#### R300 BT

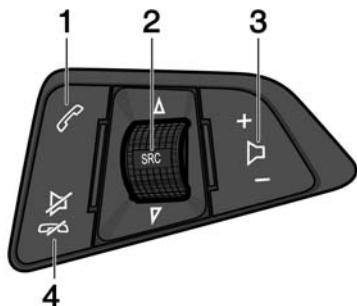

#### 1. ☎ (call)

- Press the button to answer the call or enter the recent call.
- Press and hold the button to enter the dialled call log or to move back and forth from hands-free mode and private call mode during a call.

#### 2. SRC (source) / $\Delta$ $\nabla$ (seek) dial

- When buttons are turned up or down.

In Radio modes, changes broadcast frequencies saved to - (preset) buttons.

In USB/iPod/Bluetooth audio modes, changes the file.

- When buttons are turned and held.

In Radio modes, automatically searches broadcast frequencies.

In USB/iPod/Bluetooth audio modes, rewind or fast forward the file.

- Press the button to change the audio source.

#### 3. + $\nabla$ - (volume)

- Press the buttons to increase or decrease the volume.
- Press and hold the buttons to quickly increase or decrease the volume.

#### 4. $\nabla$ (mute) / $\nabla$ (hang up)

- Press the button in any music play mode to turn the mute function on or off.
- Press and hold the button to reject or finish the call.

#### R300

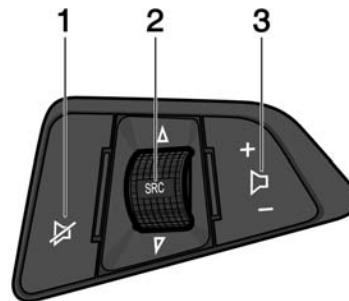

#### 1. $\nabla$ (mute)

- Press the button in any music play mode to turn the mute function on or off.

2. SRC (source) /  $\Delta$   $\nabla$  (seek) dial

- When buttons are turned up/down.

In Radio modes, changes broadcast frequencies saved to Presets.

- When buttons are turned and held.

In Radio modes, automatically searches broadcast frequencies.

- Press the button to change the audio source.

3. +  $\square$  - (volume)

- Press the buttons to increase or decrease the volume.
- Press and hold the buttons to quickly increase or decrease the volume.

## Operation

### Buttons and controlling device

the Infotainment system is operated by using the function buttons, multifunctional dial, and the menu indicated on the screen display.

the buttons and control devices used in the system are the following:

- the Infotainment system buttons and dials
- the Steering wheel audio remote control buttons

### System on/off



Press  to turn the power on.

When the power is off, pressing  will turn the power on and play a radio broadcast.

### Automatically turn power on

- When the external source is connected in the power off mode, system will turn power on and play.

If this connection is removed, system will automatically turn power off.

- When a call is received or initiated, the power is turned on and the action is carried out.

If this action is ended, system will automatically turn power off.

- When pressing an HVAC (Heating, Ventilation, and Air Conditioning) related button, system will turn power on and operate this action.

If no action is taken within 5 seconds, the system will automatically turn power off.

## 100 Infotainment System



Press and hold  to turn the power off.

When the System is turned off, the time of Day is displayed.

### Volume control





Turn the VOLUME dial to control the volume.

- Using the Steering wheel audio remote control, press +  - to control the volume.
- Available volume range: 1 ~ 63.
- When the volume is turned down to zero, this is not equivalent to mute mode.
- Turning on the Infotainment system power will set the volume level to its previous selection (when it is less than the maximum starting volume).

### Mute control

Press  to turn mute on.

- Mute symbol " " will display in the status field and mute the sound.
- Press  again or turn VOLUME dial to restore sound.
- In USB mode, when the system is set to mute, playback is paused.

### Tone settings

Press TONE to enter the Tone Settings screen.

Or press MENU > select Settings > select Tone Settings to enter the Tone Settings screen.

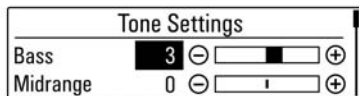

- Turn the TUNE dial to select the Tone Settings mode. Use this dial to switch between Bass ↔ Midrange ↔ Treble ↔ Fade ↔ Balance ↔ EQ.
- Highlight the desired tone setting option and press MENU to be able to change its current value.
- Turning the TUNE dial will change the tone setting value and the changes will be reflected in the bar graphic on the display.

Press MENU to store the new setting and return to the Tone Settings screen.

### Tone setting menu

- **Bass:** Sets the bass sound level.
- **Midrange:** Sets the middle sound level.
- **Treble:** Sets the treble sound level.
- **Fade:** Sets the sound fade between the front and rear speaker.
- **Balance:** Sets the sound balance between the right and left speaker.
- **EQ:** Sets one of the 7 EQ styles (Custom, Pop, Rock, Country, Jazz, Talk, Classical).
- The tone settings values range between -12 and +12.

### Select function

#### AM-FM radio or DAB



Press RADIO to select the AM, FM or DAB function.

Press MENU to open the AM, FM or DAB menu that includes options for selecting broadcast stations.

## 102 Infotainment System

### USB/iPod/Bluetooth music or exterior sound (AUX) input play

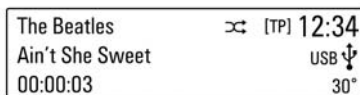

Press MEDIA to select the audio player functions.

Each time MEDIA is pressed, the system switches between USB/iPod → AUX → Bluetooth music → USB/iPod → ...

Press MENU to open the menu with options for the relevant function or the menu of the relevant device.

### Bluetooth hands-free phone device

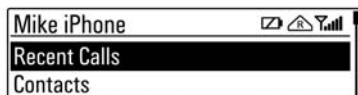

Press PHONE to enter the Bluetooth hands-free phone function.

## Radio

### AM-FM Radio

#### Listening to radio or DAB station

#### Selecting the radio mode



Press RADIO repeatedly to switch between AM RADIO → FM RADIO → DAB → AM RADIO → ....

- The previously chosen broadcasting station will be received.

- When changing Radio mode/ band by pressing RADIO, the system displays radio intro view firstly.
- The playing screen contains the data elements related to the broadcast audio source.

### Selecting the DAB mode

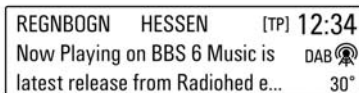

Each time RADIO is pressed, the system switches between AM RADIO → FM RADIO → DAB → AM RADIO → ....

- An 8 character service label and an 8 character ensemble label will be used.

- The Dynamic Label is displayed as artist/song info when available from the station.
- When DAB signal information has been detected, this information will be updated on the display to show the information.
- The information and formatting displayed with Dynamic Label Text will vary based on the information and formatting provided by the broadcaster.
- DAB information such as Station Label, Ensemble Label, Dynamic Label Text are not be displayed until complete reception.
- When there is more information than displayable in the Dynamic Label Text space, the text fields of lines 2 and 3 will be shown.
- When there is no station information available but the ensemble is known, the station label will be replaced with the text "**No Label**".
- When there is no ensemble information available but the Station Label is known, the ensemble label will be replaced with the text "**No Label**".
- When there is no station or ensemble information available, the display will show the DAB block number and frequency in the display screen (e.g. 10C, 213.360).
- When tuned to a DAB+ station, the default text displayed for the user will be the dynamic label plus a variant for artist and song only. No other variations of dynamic label plus will be displayed.
- When tuned to a DAB+ station, if there is no information available from the broadcaster, the dynamic label text will be populated with the standard dynamic label text.



## 104 Infotainment System

### Station search

Press **◀◀ / ▶▶** to automatically search for radio station with superior reception.

Pressing and holding **◀◀ / ▶▶** continuously changes the station until the button is released. After the release, the system stops at the current frequency displayed or seeks for the next station.

### Seeking for DAB service component

Press **◀◀ / ▶▶** to automatically search for the station of the ensemble with superior reception.

Pressing and holding **◀◀ / ▶▶** continuously changes the station and ensemble until the button is released. After the release, the system stops at the current station displayed or seeks for the next station.

- If the next or previous station is located in another ensemble, then the first or last receivable strong station of that ensemble is tuned.

- If there are no strong signal stations, the display will show **"No DAB Stations Available"**.

### Linking the DAB service

In DAB mode, press **MENU >** turn the TUNE dial to select the DAB linking feature **>** press **MENU** to turn the DAB linking feature on or off.

- The DAB linking feature:

**DAB to DAB linking:** On or Off

**DAB to FM linking:** On or Off

- When DAB to DAB linking is set to On status and the currently tuned DAB station weakens and fails, the system will directly search and link quickly to a related FM station.
- When DAB to FM linking is set to the On status and the currently tuned DAB station weakens and fails, the system will attempt to link to the FM variant of the service.

DAB to DAB linking is either deactivated or has failed.

### Tuning a radio station manually

Turn the TUNE dial to manually find the desired broadcasting frequency.

### Tuning a DAB station manually

Press **MENU** to enter the DAB menu.

Turn the TUNE dial to select DAB manual tuning, and then press **MENU**.

Turn the TUNE dial to manually find the desired broadcasting frequency, and then press **MENU**.

- The station list is arranged in the order of channel labels.

### Using the DAB stations list

Turn the TUNE dial to show the DAB stations list.

- The station list information will be displayed.
- If the station list is empty, DAB stations list updating is started automatically.

Turn the TUNE dial to select the desired list, and then press **MENU** to receive the relevant broadcasting channel.

- When the beginning or end of the station list is reached, the tuning wraps to the beginning or end of the list depending on the direction of tuning.

### Storing favourites

Repeatedly press FAV to select the desired page of stored favourites.

Press and hold any of the - (preset) buttons to store the current radio or DAB station to that button of the selected Favourites page.

- Up to 6 Favourites pages can be stored, and each page can store up to four radio or DAB stations.
- It is possible to setup the number of the Favourites pages being used in Menu → Set Number of Favourite Pages.
- If a new radio or DAB station is stored to a - (preset) button previously stored, its previous content will be deleted and replaced with the new radio or DAB station that is stored.

- The maximum number of Favourites that a user can store is 24.

### Selecting presets

Repeatedly press FAV to select the desired FAV preset page.

- The number 1 broadcasting information of the selected FAV preset page will be displayed.

Press a - (preset) button to directly listen to the radio or DAB station stored to that button.

### Waveband menus

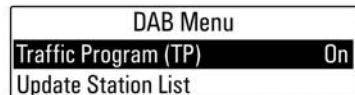

While listening to the radio, press MENU to enter the AM, FM or DAB menu.

Turn the TUNE dial to move to the desired menu item, and then press MENU to select the relevant item or to enter the item's detailed menu.

### AM-FM menu

- **Station list:** Selects a station in the list of strong stations.
- **Update station list:** Automatically searches and saves receivable frequencies to the Station List.
- **Manual tuning:** Briefly turn the dial to move to the previous/next frequency.
- **Set number of favourites page:** Set the number of Favourites pages.

## 106 Infotainment System

### DAB menu

- **Traffic program (TP):** Turn TP feature on or off.
- **Categories (DAB category):** Selects a station from the list.  
  
The list is displayed in the order of Information → Pop → Rock → Classical → Music → All.
- **DAB announcements:** Enter the DAB announcements menu, and then set the list entry of interest.  
  
Available announcements :  
News → Weather → Sports → Finance → Travel → Event → Special → Radio Info → Warning → Traffic → Alarm.
- **DAB to DAB linking:** Turn the DAB linking feature on or off (activate or deactivate the Auto ensemble linking function).
- **DAB to FM linking:** Turn the FM linking feature on or off (activate or deactivate the Auto linking DAB-FM function).

- **L band:** Turn L Band feature on or off.  
  
When L Band is turned on, the system will seek/tune the station to include the L Band frequency blocks.
- **Intellitext:** Selects the specially broadcast text providing information such as sports scores, headline news, and others.

### Radio Data System (RDS)

The Radio Data System (RDS) is a service by FM stations that considerably makes it easier to find radio stations with fault-free reception.

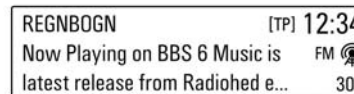

RDS stations are indicated by the program service name instead of the broadcasting frequency.

When TP is on, the search will only include TP supported stations or stations with EON-TA support.

When TP is off, the search will include all available stations.

The basic operation such as tuning/ seeking the stations and storing/ selecting presets is the same as for AM, FM or DAB. Please refer to the AM, FM or DAB section for more information.

### Adjust the RDS menu

While listening to the radio, press MENU to enter the FM Menu.

Turn the TUNE dial to move to the desired menu item, and then press MENU to select the relevant item or to enter the item's detailed menu.

- **Traffic program (TP):** Turn the TP feature on or off.

When TP is turned on in the FM menu, the system will initiate a TP search in order to tune to the strongest available TP station.

- **RDS:** Turn the RDS feature on or off.

When RDS is turned on, the program service name of the current station appears instead of its frequency.

When RDS is turned off, the RDS Text will be switched off, the alternate frequency feature will not function, and the frequency will be displayed in the place of the PSN (PS name).

- **Region:** Turns the Region feature on or off.  
Only alternative frequencies with the same regional programmes are selected.
- **Categories (FM category):** Selects a station from the list.  
The list is displayed in the order of Information → Pop → Rock → Classical → Music → All.

### Volume of the traffic announcements (TA)

While the Traffic Alert is playing, the Traffic alert volume can be adjusted by turning the VOLUME dial.

The system will store this setting for future traffic alerts.

- Once an alert is completed, the system volume returns to its previously set level prior to the traffic alert.
- If the traffic alert volume is set to zero during an alert, the next traffic alert will arrive at the minimum connection volume level.

- The same process will apply to DAB Announcements.

### Radio traffic service

(TP : Traffic Program)

Radio traffic service stations are RDS stations that broadcast traffic news.

Press MENU > turn the TUNE dial to select TP > press MENU to turn the TP feature on or off.

- If the current station is not a radio traffic service station, then a search is automatically started for the next radio traffic service station.
- Once a radio traffic service station has been found, "TP " is displayed in the display screen.
- If the radio traffic service is switched on, then it is interrupted for the duration of the traffic announcement in all modes.

## 108 Infotainment System

### Blocking out traffic announcements

If a traffic alert comes in while listening to an audio source, the system will display the Traffic Alert Pop-up.

The pop-up will display with a Dismiss option highlighted by default for the alert.

- If a Traffic Alert pop-up is displayed, the Traffic Alert pop-up can also be dismissed by SRC on the SWC.
- If a Traffic Alert pop-up is displayed when an external device is connected, the system does not read the device.
- If a Traffic Alert pop-up is displayed while a call comes in or is initiated, the call is received or made.
- If the above phone event is ended, the system will cancel the TA event, and then go back to the latest radio mode.

### Audio Players

#### Auxiliary Devices

##### USB player

##### Cautions for using USB devices

- Operation cannot be guaranteed if the HDD built-in USB mass storage device or CF or SD memory card is connected by using a USB adaptor. Use a USB or flash memory type storage device.
- Take caution to avoid static electricity discharge when connecting or disconnecting the USB. If connection and disconnection are repeated many times in a short time, this may cause a problem in using the device.
- Operation is not guaranteed if the connecting terminal of the USB device is not metal.

- Connection with i-Stick Type USB storage devices may be faulty due to vehicle vibration, so their operation cannot be guaranteed.
- Be careful not to touch the USB connecting terminal with an object or any part of your body.
- The USB storage device can only be recognised when it is formatted in FAT16/32 file format. Only devices with an allocated unit size of 512 byte/sector or 2,048 byte/sector can be used. NTFS and other file systems cannot be recognized.
- According to the type and capacity of the USB storage device and the type of the stored file, the time it takes to recognise the files may differ. This is not a problem with the product in this case, so please wait for the files to be processed.
- Files in some USB storage devices may not be recognised due to compatibility problems, and connections with a memory reader or a USB hub are not

supported. Please check the device's operation in the vehicle before use.

- When devices such as an MP3 player or digital camera are connected through a mobile disc, it may not operate normally.
- Do not disconnect the USB storage device while it is being played.

This may cause damage to the product or the performance of the USB device.

- Disconnect the connected USB storage device when the vehicle ignition is turned off. If the ignition is turned on while the USB storage device is connected, the USB storage device may be damaged or may not operate normally in some cases.

### Caution

USB storage devices can only be connected to this product for the purpose of playing music files.

The product's USB terminal should not be used to charge USB accessory equipment since the heat generation using the USB terminal may cause performance issues or damage to the product.

- When the logical drive is separated from a mass USB storage device, only the files from the top-level logical drive can be played as USB music files. This is the reason that the music files to be played should be stored in the top-level drive of the device. Music files on particular USB storage devices may also not be normally played if an application is loaded by partitioning a separate drive inside the USB device.

- Music files to which DRM (Digital Right Management) is applied cannot be played.

This product can support USB storage devices that are up to 16 Gigabytes in capacity with a limit of 6,000 files, 100 folders, and 8 stages of folder structure. Normal usage cannot be guaranteed for storage devices that exceed this limit.

If the device loading time takes longer than usual, use after formatting the USB into FAT16/32 format.

### Caution for using USB music files

- Damaged music files may be cut-off during playback or may not be played at all.

### About MP3 (WMA) music files

- The MP3 files that can be played are the following:
  - Bit rate: 8 kbps ~ 320 kbps

## 110 Infotainment System

- Sampling frequency:  
48 kHz, 44.1 kHz, 32 kHz (for MPEG-1)  
24 kHz, 22.05 kHz, 16 kHz (for MPEG-2)
- This product displays MP3 (WMA) files with the mp3, .wma (lower case letters) or .MP3 or .WMA (capital letters) file name extensions.
- This product can display ID3 tag (Version 1.0, 1.1, 2.2, 2.3, 2.4) information about album, artist, etc. for MP3 files.
- This product can play MP3 files which use VBR. When a VBR type MP3 file is being played, the remaining time displayed may be different from the actual time remaining.

### Order of playing music files

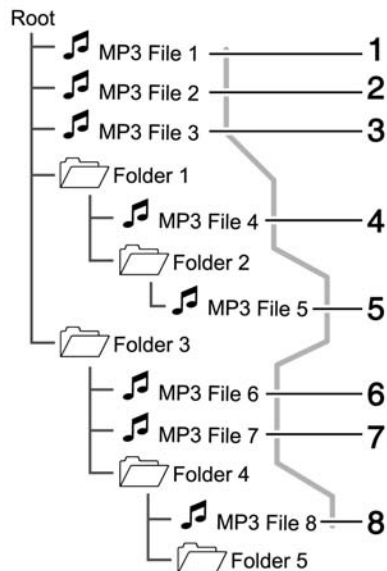

### Connecting the USB storage device

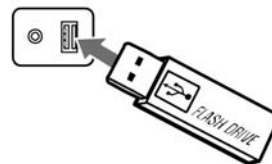

Connect the USB storage device in which music files are stored to the USB connection terminal.



Once the product finishes reading the information on the USB storage device, it will automatically start playing.

If a non-readable USB storage device is connected, an error message will appear and the product will automatically switch to the previously used function or the FM radio function.

If the USB storage device to be played is already connected, repeatedly press MEDIA to select the USB player.

- It will automatically play from the previous playing point.

- If there is no device connected, “**No Media Available**” will be displayed with a DISMISS and PAIR option on the display screen.
- The information displayed includes the file name, folder name, and ID3 Tag information saved with the song.

If incorrect ID3 Tag information (e.g. artist, song title) was added to MP3 (WMA) files before they were burnt to a disc, this information will be displayed as is by the Infotainment system.

Incorrect ID3 Tag information cannot be modified or corrected on the Infotainment system (ID3 Tags can only be corrected on a PC).

The information for songs expressed in special symbols or in unavailable languages may be displayed as “\*\*\*\*\*” or are not displayed at all.

#### **Ending USB music files playback**

Press RADIO or MEDIA to select other functions.

#### **Selecting playing file**

While playing, press ◀◀ / ▶▶ to select the previous or next file.

Using the Steering wheel audio remote control, files can be easily changed by pressing ◀◀ / ▶▶.

Turn the TUNE dial to move the desired file in the file list, and then press MENU to instantly change it.

#### **Fast-forwarding and re-winding the file**

While playing, press and hold ◀◀ / ▶▶ to rewind or fast-forward through the song until released.

Once released, the file will begin playing at normal speed.

#### **Using the USB menu**

While playing the file, press MENU to enter the USB Menu.

Turn the TUNE dial to move to the desired menu item, and then press MENU to select the relevant item or to enter the item's detailed menu.



## 112 Infotainment System

- **Folder View:** Enter the Folder View mode, and move to the previous or next folder.
- **Shuffle:** Turn the shuffle feature on or off.

### Browsing/indexing device

- Browsing is not supported until indexing is completed for the connected device.
- If the browse function is selected during the indexing process, a pop-up **“Feature not supported during Indexing Use folder view to browse contents ”** will display.
- When a single device with greater than 6,000 songs is connected, a pop-up **“Media indexing memory full Use folder view or remove other device ”** will display.

### Remove USB

Remove the USB device from the USB connection terminal.

If the USB device is removed, the system will display the No Connection message for each

source on the display screen and keep the current status until the device is reconnected.

### Using the Media transfer protocol (MTP) menu

**Charge Only:** Select the charge option for the MTP device. The MTP device will be charged, and the system will show the pop-up message, when it is connected.

- The default setting is Charge Only.
- When the Charge Only option is selected in the Media Transfer Protocol (MTP) Setting Menu, the audio source is not changed and the connected device is only charged.
- If you change to USB mode while charging the device, a Charge message with charging activity indicator is shown on the display screen. In this case, the system will not start indexing the files on the device.
- Charging may not be supported by some MTP devices.

**Scan Music Folder Only:** Select the Music Folder Scan option for the MTP device.

The system can display the Artist Name/Song Name/Elapsed Time regarding the current song and access the playlist on the MTP device.

**Scan All Folder:** Select the All Folder scan option for the MTP device.

- The device indexing time takes longer than the setting of Scan Music Folder Only. It depends on the smartphone and the files/folders on the smartphone.
- With some phones featuring Media Transfer Protocol (MTP), music search can take a long time.
- If the phone screen is locked, you cannot search for music. To access music on the phone, unlock the phone screen.

## iPod player

### Connecting iPod player

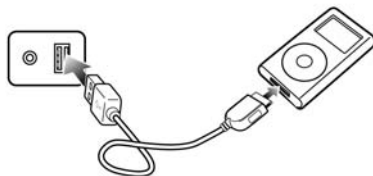

Connect the iPod device in which the music files are stored to the USB connection terminal.

Some iPod/iPhone product models may not be supported.

Only connect the iPod to this product with connection cables supported by iPod products. Other connection cables cannot be used.

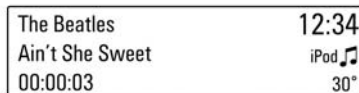

- In some cases, the iPod product may be damaged, if the ignition is turned off when it is connected to the product.

When the iPod product is not being used, keep it separately from this product with the car ignition turned off.

- Once the product finishes reading the information on the iPod device, it will play automatically.
- If a non-readable iPod device is connected, then the relevant error message will appear and the product will automatically

switch to the previously used function or the FM radio function.

If the iPod device to be played is already connected, repeatedly press MEDIA to select the iPod player.

- It will automatically play from the previously played point.
- The playback functions and the information display items of the iPod player used with this product may be different from the iPod in terms of play order, method, and the information displayed.

Afterwards, the functions to play the iPod are operated similarly to USB playback.

### Ending iPod playback

To end playback, press RADIO or MEDIA to select other functions.

### Using the iPod menu

While playing the file, press MENU to enter the Menu iPod.

## 114 Infotainment System

Turn the TUNE dial to move the desired menu item, and then press MENU to select the relevant item or to enter the item's detailed menu.

- **Browse "Device Name"**: Selects a list item in the list of browse names such as Playlists, Artists, Albums, Tracks, Genres, Audio Books, and Composers.
- **Shuffle**: Turn the shuffle feature on or off.

### Remove iPod

Remove the iPod from the USB connection terminal.

When the iPod is removed, the system automatically changes to the previously used function or the FM radio.

### AUX input

#### Connecting an exterior sound device

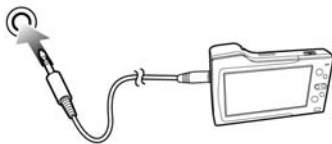

Connect the audio output of the external audio equipment to the AUX input terminal.

- The Infotainment system will automatically switch to the exterior sound (AUX) input mode when the exterior sound device is connected.



Press MEDIA to switch to the exterior sound input mode if the exterior sound system has already been connected.

Turn the VOLUME dial to adjust the volume.

## Personalisation

### How to use the Settings menu for personalisation

- Settings menus and functions may differ according to car model.
- The settings menu comprises a detailed list for the relevant setup menu or functioning state.
- If there is another detailed list from the relevant detailed list, you can repeat this action.

Select Settings in the Menu > turn the TUNE dial to move to the desired menu item > press MENU to enter the item's detailed menu.

### Setting the time and date

**Set time :** Manually set the hours and minutes for the current time.

- Press Set Time in the Time and Date menu.
- Press - to select the Time format 12HR or 24HR.
- Turn the TUNE dial to change the hour, and then press MENU to move to the Minute Setting.

- Turn the TUNE dial to change the minute, and then press MENU to move to the AM or PM Setting.
- Turn the TUNE dial to select the AM or PM, and then press MENU to finish the Time Setting. When MENU is pressed, the Time and Date menu is automatically displayed.

**Set date :** Manually set the current year, month or date.

Press Set Date in the Time and Date menu.

Press - to select the Date format.

The format shows:

DD/MM/YYYY: 15. Oct. 2014  
MM/DD/YYYY: Oct. 15. 2014  
YYYY/MM/DD: 2014. Oct. 15

- Turn the TUNE dial to change the Month, and then press MENU to move to the Day Setting.
- Turn the TUNE dial to change the Day, and then press MENU to move to the Year Setting.

- Turn the TUNE dial to change the Year, and then press MENU to finish the Date Setting. When MENU is pressed, the Time and Date menu is automatically displayed.

### Set time and date automatically.

Press - to select the Time setting mode in the Set Time menu.

- **Off (Manual):** Activates manual mode.
- **On-Cell Network:** Set the Cell Network clock synchronization feature on or off.
- **On-RDS:** Set the RDS clock synchronization feature on or off.

### Setting the tone

- For details, see *page 7*.

### Setting the auto volume

Auto Volume adjusts the volume of the audio based on the speed or ambient noise of the vehicle.

- **Off:** Auto Volume does not act.

## 116 Infotainment System

- **Low:** A lower range volume curve is used to adjust audio volume with changes in vehicle speed.
- **Medium-Low:** Medium-Low will adjust Auto Volume to approximately the range between low to medium respectively.
- **Medium:** A middle range volume curve is used to adjust the audio volume with changes in vehicle speed.
- **Medium-High:** Medium-High will adjust Auto Volume to approximately the range between medium to high respectively.
- **High:** A more aggressive volume curve is used to adjust the audio volume with changes in vehicle speed.

### Setting the maximum start-up volume

Manually set maximum limit for the start-up volume.

### Setting the language

Turn the TUNE dial to select the Vehicle Settings in the Settings menu > press MENU > turn the TUNE dial to select Languages > press MENU to enter the item's detailed menu.

Select the desired language for displaying.

### Return factory settings

Turn the TUNE dial to select the Vehicle Settings in the Settings menu > press MENU > turn the TUNE dial to select Return to Factory Settings > press MENU to enter the item's detailed menu.

Restore all settings to the default settings.

### Software information

Turn the TUNE dial to select Vehicle Settings in the Settings menu > press MENU > turn the TUNE dial to select Software Information > press MENU to enter the item's detailed menu.

Shows the current Software version, and DAB Software version.

## Phone

### Bluetooth ((Type A/ B only))

#### About Bluetooth

#### About Bluetooth wireless technology

- Bluetooth<sup>®</sup> Wireless Technology refers to a short-distance wireless networking technology which uses a 2.45GHz frequency to connect various devices within a certain distance.
- Supported by PCs, external devices, Bluetooth<sup>®</sup> phones, PDAs, various electronic devices, and automotive environments, Bluetooth<sup>®</sup> Wireless Technology transmits data at high speed without having to use a connector cable.
- Bluetooth<sup>®</sup> Hands-free refers to a device which allows the user to conveniently make phone

calls with Bluetooth® mobile phones through the multimedia system.

### **Before connecting the Bluetooth unit**

- Before connecting the head unit with the mobile phone, check to see that the mobile phone supports Bluetooth features.
- Even if the phone supports Bluetooth Wireless Technology, the phone will not be found in a search" if the phone has been set to hidden mode or if the Bluetooth power is turned off.
- Disable the hidden mode or turn on the Bluetooth power prior to searching or connecting with the head unit.
- If Auto Connection is used, the Bluetooth phone automatically connects to the system when the ignition is turned on.
- If you do not want automatic connection with your Bluetooth device, turn the Bluetooth feature off on the Bluetooth device.

- Park the vehicle when connecting the unit with the mobile phone.
- Bluetooth connection may be intermittently disconnected depending on the phone. Follow these steps to try again.
  - Turn the Bluetooth® function within the mobile phone OFF/ON and try again.
  - Turn the mobile phone power OFF/ON and try again.
  - Completely remove the mobile phone battery, reboot, and try again.
  - Reboot this unit and try again.
  - Delete all paired devices, pair and try again.
- The hands-free call volume and quality may differ depending on the mobile phone.
- Pairing Bluetooth devices and the use of Bluetooth features are not supported when the vehicle is in motion. Please park your vehicle first.

- The process of downloading contacts may differ depending on the mobile phone.

In case of events not described within this manual, see *the mobile phone manufacturer's user guide*.

- As a Bluetooth wireless connection can have a range of up to 10 meters, your Bluetooth device may automatically connect to the system even if the device is not inside the vehicle. Please consider this, especially when pairing or connecting Bluetooth devices to the Infotainment system when other Bluetooth devices may be within range.
- This unit uses the latest Digital Noise & Echo suppression system to provide the best sound clarity with little or no distortion, but under some conditions there may still be some echo and noise experienced within the vehicle.

## 118 Infotainment System

It is recommended to keep the car windows closed during hands-free calls for best results.

- This unit uses the following Bluetooth profiles:
  - Phone Book Access Profile (PBAP)
  - Hands Free Profile (HFP)
  - Advanced Audio Distribution Profile (A2DP)
  - Audio Video Remote Control Profile (AVRCP)
- If the Bluetooth profiles do not match, the system will display the "Action not supported by this device" pop-up on the display screen (e.g. device is not able to control the TUNE dial).

### Before using Bluetooth music mode

- Bluetooth Audio mode can be used only if a Bluetooth Audio device has been connected.
- If music is not yet playing from your mobile device after switching to streaming audio (Bluetooth Audio) mode or after

pressing Play on the mobile device itself, try to start music playback by pressing the Play button again.

- Check whether music from the Bluetooth device is playing after converting to streaming audio mode. The Streaming audio feature may not be supported by some mobile phones.
- If the Bluetooth phone is disconnected while Bluetooth Audio mode is active, then the music will also stop.
- Bluetooth streaming audio may not be supported by some mobile phones.
- If the Bluetooth indicator is not displayed, then no Bluetooth device is connected or the connection is not of satisfactory quality.
- This unit can pair up to 5 Bluetooth devices.

## Connecting Bluetooth

### Registering the Bluetooth device

Register the Bluetooth device to be connected to the Infotainment system.

Firstly, set up the Bluetooth device to be connected from the Bluetooth settings menu to enable other devices to search for the Bluetooth device.

Press PHONE to enter the Phone application mode.

To select Pair, press -. The information "**Name: Device name / PIN: 0000**" appears in the display screen and then the Pairing progress starts.

- If no phone source is connected, the status region displays "**No Device Paired**".
- To change the PIN, press the - and select New Pin in the Pair menu. Turn and press MENU to change the PIN.

From the Bluetooth device, search for this unit and pair the device.

1. Turn on Bluetooth on your phone.
2. Search and select device "**Device name**" in the Bluetooth menu.
3. Enter this item on your phone.

To learn more about searching from Bluetooth devices and pairing, refer to the user's manual of your Bluetooth device.

After a while, the Bluetooth device is automatically registered.

- If the registration of the device to be connected to the system is successful, "**Bluetooth Connected**" appears in the display screen.
- After Pairing is completed, a contacts download request is sent to your mobile phone. Please check your phone and accept the download request if necessary.

When pairing a second device, repeat the above steps.

- If a Bluetooth device is connected, a new device cannot be paired. If you want to pair a new phone, first disconnect the connected Bluetooth device.
- This unit can pair up to 5 Bluetooth devices.

#### **Adding/Connecting/ Disconnecting/Deleting the Bluetooth devices**

Firstly, set up the Bluetooth device to be connected from the Bluetooth set-up menu to enable other devices to search for the Bluetooth device.

Press PHONE > press MENU to select the Bluetooth Devices to enter the Phone List menu > turn the TUNE dial to move to a device list item > press - to select the desired menu item.

- **Select Add:** The information "**Name: Device name / PIN: 0000**" appears in the display screen and then the Pairing progress starts.

- **Select Connect:** After a while, the Bluetooth device is automatically connected, and "**Bluetooth Connected**" appears on the display screen.
- **Select Disconnect:** Disconnect the connected Bluetooth device from the Phone List menu.
- **Select Delete:** Delete the registered Bluetooth device from the Phone List menu.

#### **Bluetooth music player**

##### **Connecting Bluetooth music player**

Connect the Bluetooth device on which the music files are stored.



## 120 Infotainment System



Repeatedly press MEDIA to select the Bluetooth Music mode.

- Audio file within the Bluetooth device will automatically play once "**Bluetooth Music**" is displayed on the display screen.
- If music is not yet playing from your mobile device after switching to streaming audio (Bluetooth Music) mode or after pressing Play on the mobile device itself, try to start music playback by pressing the Play button again.

While playing, press ◀◀ / ▶▶ to move to the previous or next track.

- This function only operates with Bluetooth devices that support Audio Video Remote Control Profile (AVRCP) version 1.0 or above. (Depending on the Bluetooth device options, some devices may display Audio Video Remote Control Profile (AVRCP) being connected for the initial connection.)
- If the Bluetooth device is disconnected while Bluetooth music is playing, the music will also stop.

Afterwards, the functions to play Bluetooth Music are operated similarly to USB playback.

### Using the Bluetooth music menu

While playing, press MENU to enter the Bluetooth Audio Menu. Turn the TUNE dial to move to the desired menu item, and then press MENU to select the relevant item or to enter the item's detailed menu.

- **Browse "Device Name"**: Select a list item in the list of browse names. If the Bluetooth profiles do not match, the system will display "**Action not supported by devices**".  
Support Profile version : Audio Video Remote Control Profile (AVRCP) 1.4.
- **Shuffle**: Turn the shuffle feature on or off.
- **Manage Bluetooth devices**: Enter the Phone List menu.

### Emergency call

#### Warning

Connection setup cannot be guaranteed in all situations. For this reason, do not rely exclusively on a mobile phone when a vitally important communication (e.g. a medical emergency) is concerned.

(Continued)

### Warning (Continued)

On some networks, it may be necessary for a valid SIM card to be properly inserted in the mobile phone.

### Warning

Bear in mind that you can make and receive calls with the mobile phone, if it is in a service area with a sufficiently strong signal. Under certain circumstances emergency calls cannot be made on all mobile phone networks; it is possible that they cannot be made when certain network services and/or telephone functions are active. You can enquire about this with the local network operators.

The emergency call number can differ depending on the region and country. Please enquire

(Continued)

### Warning (Continued)

beforehand about the correct emergency call number for the relevant region.

### Making an emergency call

Dial the emergency call number (e.g. 112).

The telephone connection to the emergency call centre is set up.

Answer when the service personnel questions you about the emergency.

### Warning

Do not end the call until you are requested to do so by the emergency call centre.

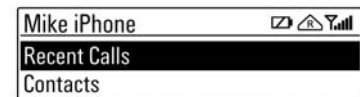

### Operation



### Incoming call

When a phone call comes in on the connected Bluetooth mobile phone, the playing track will be cut off and the phone will ring with the relevant information displayed.

To receive a call, press  on the steering wheel audio control to move to the Active Call screen or press - to select Answer to move to the Active Call screen.

To reject a call, press and hold  /  on the steering wheel audio control or press - to select Ignore.

## 122 Infotainment System

- An ignored call is sent to the voice mail box, the ringtone stops, and the alert is extinguished, returning the display to the previous screen prior to the alert.
- If the call is not ignored or answered before it is transferred to the voice mail box, the alert will extinguish returning to the previous screen and the ringtone stops.

### Call waiting

If another person calls while you are already on the phone, the system displays a second incoming call pop-up.

Press PHONE or  on the steering wheel audio control to switch between 1st call and 2nd call.

If two calls are active (call waiting mode), a call waiting alert is not displayed.

### Phone volume control

Turn the VOLUME dial to adjust the Phone Volume while in an active phone call (e.g. through volume steps 0 ~ 63).

#### Caution

It is possible to transfer your ringtone depending on the mobile phone.

Adjust the ringtone volume of the mobile phone if the volume is too low.

You can use the volume control to adjust the Ring Tone Volume while the ring tone is given out starting at a defined minimum volume. The volume ranges from level 3 to max.

### During a call

During the active call, the Active Call screen displays information relevant for the active phone call.

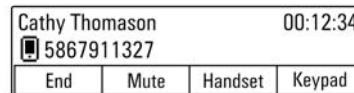

**End:** End an active phone call.

When a call is ended, the system returns to the screen active before the call.

**Mute/Unmute:** Mute the vehicle microphone while in an active call by pressing the button.

If the microphone is muted, the label changes Unmute. Press the button again to unmute the microphone.

**Handset/hands-free:** Switch from hands-free mode to the phone handset mode by pressing - directly.

- If the phone call on the active phone source is handled in handset mode, the label changes to hands-free.
- Pressing the button now returns the phone conversation to hands-free mode.
- The hands-free mode is default when a call is initiated.
- If there is an issue and the call is not transferred to hands-free or handset as the user requested, a message is displayed notifying the user that the transfer could not be carried out. Please retry.

**Keypad** : Enter the Keypad screen.

### Ending a call

If a call is ended while the system is displaying any other screen than the Active Call screen, the Call Ended message is displayed.

- The call may be ended by the person on the other end of the line, from the Bluetooth handheld device or by pressing  on the steering wheel audio remote control.

- After 5 seconds, the display returns to the previous screen.

### Re-dialling a call

If the phone call was dropped, you can re-dial the number before the time out by pressing - directly below the display labelled Redial.

### Calling a number in the call log

Press PHONE to enter the Phone List menu > turn the TUNE dial to select the Recent Calls > press ENTER > turn the TUNE dial to select Missed Calls, Received Calls or Sent Calls, then press ENTER.

The recent calls list displays an intermediate menu containing missed calls, received calls, and sent calls.

Turn the TUNE dial to select a name or phone number, and press ENTER to make a call.

### Calling a number in the phone book

Press PHONE to enter the Phone List menu > turn the TUNE dial to select Contacts > press ENTER >

turn the TUNE dial to select a name or phone number, and press ENTER to make a call.

The last outgoing phone source is retained at the next ignition cycle, if that phone device is connected, and it is the outgoing phone source.

### Downloading the phone book

If the Bluetooth device supports a phone book synchronization function, the phonebook is downloaded automatically after the connection has been established.

- The call history lists can be downloaded from the connected Bluetooth device.
- Sorting call histories by time is not supported.
- It is possible to download the call history even when proceeding another action.
- It is not possible to start the download process when the call history download feature is turned off within the Bluetooth device.

## 124 Infotainment System

- After Pairing is completed, a contacts download request is sent to your mobile phone. Some phones require additional confirmation. Please check your phone and accept the download request if necessary.
- If a paired phone is deleted, its call history lists will also be deleted from the system.
- The system only uses information coded in UTF-8 format.

### Dial a number by keypad

Press PHONE to enter the Phone List menu > turn the TUNE dial to select the Keypad and press ENTER to enter the Keypad screen.

- When users select Keypad from the Phone Home Screen, a phone dialler keypad is displayed.
- Users rotate the knob to highlight the desired digit to dial and press the knob to select it.

Turn the TUNE dial to highlight the desired digit to dial and press ENTER to select it.

You can enter max 24 digits.

- If the user continues to turn the knob when the end of the keypad is reached, it jumps to the other side of the keypad.
- Digits are displayed in the digit screen as they are entered.
- The Call button is not active until the user has input a digit.
- Once the user has entered the desired phone number, press - to begin calling that number.
- While the connection is established, the system displays the Active Call screen.
- If the user made a mistake while entering a phone number, turn the TUNE dial to highlight Delete and press the knob to delete the last digit entered.
- Pressing and holding the knob for the standard time while Delete is highlighted clears the entire digit field.

### Bluetooth devices view

Press PHONE to enter the Phone menu > turn the TUNE dial to select the Bluetooth Devices > press ENTER to enter the Phone List menu.

- The list contains the device names of all Bluetooth devices that have been paired with the system.
- If the device name received is blank, Unknown is displayed.
- From the Bluetooth Device List menu, the user may add (pair) a device, delete a device, and connect a device.

### Text messages

When a Text Message is received by the connected Bluetooth mobile phone, the playing track will be cut off and the phone will display the relevant information.

- If the sender is registered in the phone book, the first and last name are displayed.
- If the number is not stored in the phone book, the phone number is displayed.
- The Text Message alert is displayed as soon as all information is available.

To display the entire message, press - directly below the display labelled "**View**". The detail message screen is now displayed.

## OnStar System

### OnStar Overview

If equipped, this vehicle has a comprehensive, in-vehicle system that can connect to a live Advisor for Emergency, Security, Navigation, Connection, and Diagnostic Services.

For safety, some features are disabled while the vehicle is in motion.

### Control Panel Overview OnStar Light

The OnStar system status light is next to the OnStar buttons. If the status light is :

- **Solid Green** : The OnStar system is ready to make calls
- **Flashing Green** : On a call
- **Red** : Indicates a problem
- **No Light** : OnStar subscription is not active or has expired and is not functional

### OnStar Buttons

#### **(Hands-free calling) button** :

Press to speak to an Advisor

- Make a call, end a call, or answer an incoming call.
- Give OnStar Hands-Free Calling voice commands.
- Give OnStar Turn-by-Turn Direction voice commands. Requires the available Directions and Connections service plan.

#### **(OnStar) button** : Press to connect to an Advisor

- Verify account information or update contact information.
- Get driving directions. Requires the available Directions and Connections service plan.
- Receive On-Demand Diagnostics for a check on the vehicle's key operating systems.
- Receive Roadside Assistance.

#### **(Emergency) button** : Press to connect to an Emergency Advisor

- Get help for an emergency.

## 126 Infotainment System

- Be a Good Samaritan or respond to an AMBER Alert.

Get assistance in severe weather or other crisis and evacuation routes.

### OnStar SMS

When the Short Message Service (SMS) is received by the vehicle, the pop-up screen with the message is displayed.

### OnStar Welcome

When the user joins and operates the OnStar service for the first time, the pop-up screen "**Get OnStar started now. Please, press the blue button**" is displayed.

OnStar Mobile App Download the OnStar RemoteliNK mobile app to select Apple®, Android™, and BlackBerry® devices to check vehicle fuel level, oil life, or tyre pressure; to start the vehicle (if equipped) or unlock it; or to connect to an OnStar Advisor.

### OnStar Service

#### Hans-free Calling

Press the  (Hands-free calling) button to make a call, end a call, and answer an incoming call.

Press the  (Hands-free calling) button to give OnStar Hands-Free Calling voice commands.

Press the  (Hands-free calling) button to give OnStar Turn-by-Turn Direction voice commands for automated directions.

#### OnStar

Press the  (OnStar) button to be connected to a specially trained OnStar Advisor who can verify account information and answer questions about the system.

#### Emergency

With Automatic Crash Response, the built-in system can automatically connect to help in a crash even if you cannot ask for it.

Press the  (Emergency) button to connect to an Emergency Advisor.

GPS technology is used to identify the vehicle location and can provide critical information to emergency personnel. The Advisor is also trained to offer critical assistance in emergency situations.

1.  (Power) button with VOLUME dial

- Turn the dial to adjust the volume.

- Press the button to turn mute function on/off.

7. BACK button

Cancel the input item or return to the previous screen/menu.

8. MENU button with TUNE dial

- Turn the dial to move the desired item.
- Press the button to display the menu screen provided by the current item or current mode.

10. - (Preset) buttons

- Press any of these buttons to select the channel linked to that button.

## Hands-free Calling

### Hands-free Calling

- Press the  (Hands-free calling) button to enter the OnStar Main menu.
- Say “**Call**” System responds : “**Please say the name or number to call**”
- Say the entire number without pausing, including the area code. System responds : “**OK calling**”.
- If you selects the Cancel or says “**Cancel**”, system goes to the OnStar Main menu.
- When you call someone by the some actions (say the name tag, new number, redial), the calling OSD is displayed and dialling by the OnStar 3G Module.

### Place a Call Using a Stored Number

- Press the  (Hands-free calling) button to enter the OnStar Main menu.

- Say “**Call <name tag>**.” System responds : “**Call <name tag>**”, then dial to the nametag's phone

### Store a Name Tag for Speed Dialling

- Press the  (Hands-free calling) button to enter the OnStar Main menu.
- Say “**Store**” System responds : “**Please say the number you would like to store**”
- Say the entire number without pausing. System responds : “**Please say the name tag**”
- Pick a name tag. System responds : “**About to store <name tag>Does that sound OK?**”
- Say “**Yes**” or say “**No**” to try again. System responds : “**OK, storing <name tag>**”

### Retrieve My Number

- Press the  (Hands-free calling) button to enter the OnStar Main menu.

- Say “**My number.**” System responds : “**Your OnStar Hands-Free Calling number is,**” then says the number.

### End a Call

- Press the  (Hands-free calling) button, System responds : “Call ended”

### Verify Minutes and Expiration

- Press the  (Hands-free calling) button to enter the OnStar Main menu.
- Say “**Minutes**” then “**Verify**” to check how many minutes remain and their expiration date.

### Turn by Turn Directions

OnStar navigation requires the Directions and Connections service plan.

Press the  (OnStar) button to receive directions or have them sent to the vehicle navigation screen, if equipped.



## 128 Infotainment System

- Destinations can also be forwarded to the vehicle from MapQuest.com.
- The OnStar mapping database is continuously updated. For coverage maps, see [www.onstar.com](http://www.onstar.com) (U.S.) or [www.onstar.ca](http://www.onstar.ca) (Canada).

### Turn-by-Turn Directions

- Press the  (OnStar) button to connect to a live Advisor.
- Request directions.
- Directions are downloaded to the vehicle.
- Follow the voice-guided commands.

### Using Voice Commands, During a Planned Route Cancel Route

- Press the  (OnStar) button. System responds : **“OnStar ready,”** then a tone
- Say **“Cancel route.”** System responds : **“Do you want to cancel directions?”**

- Say **“Yes.”** System responds : **“OK, request completed, thank you, goodbye ”**

### Route Preview

- Press the  (OnStar) button. System responds : **“OnStar ready,”** then a tone
- Say **“Route preview.”** System responds with the next three manoeuvres.

### Repeat

- Press the  (OnStar) button. System responds : **“OnStar ready,”** then a tone
- Say **“Repeat.”** System responds with the last direction given, and then responds with **“OnStar ready,”** then a tone.

### Get My Destination

- Press the  (OnStar) button. System responds : **“OnStar ready,”** then a tone
- Say **“Get my destination.”** System responds with the address and the distance to the

destination, and then responds with **“OnStar ready,”** then a tone.

### Using the OnStar Main menu

#### Hands-free Calling :

Press the  (Hands-free calling) button to enter the OnStar Main menu > Turn the TUNE dial to select the **“Call ”**, **“Directory ”**, **“Redial ”**, **“Store ”**, **“Minute ”** or **“Cancel ”**, then press the ENTER button.

#### Turn by Turn Directions

Press the  (Hands-free calling) button to enter the OnStar Main menu > Turn the TUNE dial to select the **“Plan Route ”**, **“Directory ”**, **“Store Destination ”** or **“Cancel ”**, then press the ENTER button.

#### OnStar Info

Press the  (Hands-free calling) button to enter the OnStar Main menu > Turn the TUNE dial to select the **“Messages ”**, **“Minutes ”**, **“My Number ”** or **“Cancel ”**, then press the ENTER button.

## Climate Controls

### Climate Control Systems

Heating and Ventilation System .....	129
Air Conditioning System .....	130
Electronic Climate Control System .....	132

### Air Vents

Adjustable Air Vents .....	135
Fixed Air Vents .....	136

### Maintenance

Air Intake .....	136
Passenger Compartment Air Filter .....	136
Air Conditioning Regular Operation .....	137
Service .....	137

## Climate Control Systems

### Heating and Ventilation System



Controls for:

- temperature
- air distribution
- fan speed
- demisting and defrosting
- air recirculation

- heated rear window ⇨ *Heated Rear Window* ⇨ 29

### Temperature

Adjust the temperature by turning the knob.

**Red:** Warm

**Blue:** Cold

Heating will not be fully effective until the engine has reached normal operating temperature.

### Air distribution

 : To head area via adjustable air vents.

 : To head area and foot well.

 : To foot well, with a small amount of the air being directed to windscreen, front door windows and side air vents.

 : To windscreen and foot well, with a small amount of the air being directed to front door windows and side air vents.



 : To windscreen and front door windows, with a small amount of the air being directed to side air vents.

## 130 Climate Controls

### Fan speed

Adjust the air flow by switching the fan to the desired speed.

### Demisting and defrosting

- Turn the air distribution knob to DEFROST .
- Set temperature control to warmest level.
- Adjust the fan control knob to highest speed for quick defrosting.
- Switch on heated rear window R .
- Open side air vents as required and direct them towards the door windows.

**Note:** If the settings for demisting and defrosting are selected, an Autostop will be inhibited.

If the settings for demisting and defrosting are selected while the engine is in an Autostop, the engine will restart automatically.

**Note:** If mode knob is set on Defrost mode , A/C operates and Recirculation mode will be fixed to outside air mode regardless of indicator status.

Stop-start system ⇨ *Automatic Engine Start/Stop Feature* ⇨ 141.

### Air Conditioning System



The air conditioning system has controls for :

**AC** : Cooling

 : Air recirculation

### Cooling

Press **A/C** to switch on cooling. Activation is indicated by the LED in the button. Cooling is only functional when the engine is running and climate control fan is switched on. Press **A/C** again to switch off cooling. The air conditioning system cools and dehumidifies (dries) as soon as the outside temperature is slightly above the freezing point. Therefore condensation may form and drip from under the vehicle. If no cooling or drying is required, switch off the cooling system for fuel saving reasons. Activated cooling might inhibit Autostops.

### Air recirculation system

The air recirculation mode is operated with . An indicator light comes on to show that the recirculation is on.

Press  again to deactivate recirculation mode.



 **Warning**

Periodically turn to the outside air mode for fresh air. The exchange of fresh air is reduced in air recirculation mode. In operation without cooling the air humidity increases, so the windows may mist up. The quality of the passenger compartment air deteriorates, which may cause the vehicle occupants to feel drowsy.



In warm and very humid ambient air conditions, the windscreen might mist up from outside, when cold air is directed to it. If windscreen mists up from outside, activate windscreen wiper and deactivate .

### Maximum cooling



Briefly open the windows so that hot air can disperse quickly.

- Switch on cooling A/C.
- Switch on air recirculation system .
- Press air distribution switch .
- Set temperature control to coldest level.
- Set fan speed to highest level.
- Open all vents.

### Demisting and defrosting the windows



- Turn the air distribution knob to DEFROST .
- Set temperature control to warmest level.
- Adjust the fan control knob to highest speed for quick defrosting.
- Switch on heated rear window R .

- Open side air vents as required and direct them towards the door windows.

**Note:** If  is pressed while the engine is running, an Autostop will be inhibited until  is pressed again.

If  is pressed while the engine is in an Autostop, the engine will restart automatically.

**Note:** If mode knob is set on Defrost mode , A/C operates and Recirculation mode will be fixed to outside air mode regardless of indicator status.

Stop-start system  *Automatic Engine Start/Stop Feature*  141.

## 132 Climate Controls

### Electronic Climate Control System



Controls for:

- temperature
- air distribution
- fan speed
- automatic mode
- air recirculation
- demisting and Defrosting

#### Temperature

Adjust the temperature by turning the knob.

**Red** : Warm

**Blue** : Cold

Heating will not be fully effective until the engine has reached normal operating temperature.

#### Air distribution

 : To head area via adjustable air vents.

 : To head area and foot well.

 : To foot well, with a small amount of the air being directed to windscreen, front door windows and side air vents.

 : To windscreen and foot well, with a small amount of the air being directed to front door windows and side air vents.



 : To windscreen and front door windows, with a small amount of the air being directed to side air vents.

#### Fan speed

Adjust the air flow by dial knob the fan to the desired speed.

In order to turn off or on, press  or adjust blower knob.

#### Automatic mode

The system automatically controls the fan speed, air delivery, air conditioning, and recirculation in order to heat or cool the vehicle to the desired temperature. When the AUTO indicator light is on, the system is in full automatic operation. If the air delivery mode, fan speed, recirculation, or air conditioning setting is adjusted, the AUTO indicator turns off. To improve fuel efficiency and to cool the vehicle faster, recirculation may be automatically selected in warm weather. The recirculation light will not come on. Press  to select recirculation; press it again to select outside air. To turn off the system, press power .

Basic setting for maximum comfort:

- Press **AUTO**.
- Open all air vents to allow optimised air distribution in automatic mode.
- Press A/C to switch on optimal cooling and demisting. Activation is indicated by the LED in the button.
- Set the desired temperature.

### Temperature preselection

Temperatures can be set to the desired value. If the minimum temperature Lo is set, the climate control system runs at maximum cooling, if cooling A/C is switched on. If the maximum temperature Hi is set, the climate control system runs at maximum heating. Recommended temperature is 22 °C.

**Note:** If A/C is switched on, reducing the set cabin temperature can cause the engine to restart from an Autostop or inhibit an Autostop ⇨ *Automatic Engine Start/Stop Feature* ⇨ 141.

### Air recirculation system

The air recirculation mode is operated with . An indicator light comes on to show that the recirculation is on.

Press  again to deactivate recirculation mode.



#### Warning



Periodically turn to the outside air mode for fresh air. The exchange of fresh air is reduced in air recirculation mode. In operation without cooling the air humidity increases, so the windows may mist up. The quality of the passenger compartment air deteriorates, which may cause the vehicle occupants to feel drowsy.

### Demisting and defrosting the windows

- Press . Activation is indicated by the LED in the button. And recirculation mode is to be set

and to be fixed to outside air mode, automatically. The air conditioning system operated but an indicator light is no change.

- Temperature and air distribution are set automatically and the fan runs at high speed.
- Switch on heated rear window R .
- To return to previous mode : Press , to return to automatic mode: press **AUTO**

**Note:** If  is pressed while the engine is running, an Autostop will be inhibited until  is pressed again.

If  is pressed while the engine is in an Autostop, the engine will restart automatically.

Stop-start system ⇨ *Automatic Engine Start/Stop Feature* ⇨ 141.

## 134 Climate Controls

### Manual settings

Climate control system settings can be changed by activating the buttons and rotary knobs as follows.

Changing a setting will deactivate the automatic mode.

### Fan speed



Adjust the air flow by switching the fan to the desired speed. The selected fan speed is indicated by the number of segments in the display. If the fan is switched off the air conditioning is also deactivated.

To return to automatic mode, press **AUTO**.

### Air distribution





Press appropriate button for desired adjustment. Activation is indicated by the LED in the button.

 : To head area via adjustable air vents.

 : To head area and foot well.

 : To foot well, with a small amount of the air being directed to windscreen, front door windows and side air vents.

 : To windscreen and foot well, with a small amount of the air being directed to front door windows and side air vents.

 : To windscreen and front door windows, with a small amount of the air being directed to side air vents.

Return to automatic air distribution :  
Press **AUTO**

### Cooling





Press **A/C** to switch on cooling. Activation is indicated by the LED in the button. Cooling is only functional when the engine is running and climate control fan is switched on. Press **A/C** again to switch off cooling. The air conditioning system cools and dehumidifies (dries) when outside temperature is above a specific level. Therefore

condensation may form and drip from under the vehicle. If no cooling or drying is required, switch off the cooling system for fuel saving reasons.

Activated cooling might inhibit Autostops ⇨ *Automatic Engine Start/Stop Feature* ⇨ 141.

### Air recirculation system

Press  to activate air recirculation mode. Activation is indicated by the LED in the button.

Press  again to deactivate recirculation mode.



#### Warning

The exchange of fresh air is reduced in air recirculation mode. In operation without cooling the air humidity increases, so the windows may mist up from inside. The quality of the passenger compartment air deteriorates, which may cause the vehicle occupants to feel drowsy.

In warm and very humid ambient air conditions, the windscreen might mist up from outside, when cold air is directed to it. If windscreen mists up from outside, activate windscreen wiper.

### Maximum cooling

Briefly open the windows so that hot air can disperse quickly.

- Switch on cooling A/C.
- Switch on air recirculation system .
- Press air distribution switch .
- Set temperature control to coldest level.
- Set fan speed to highest level.
- Open all vents.

## Air Vents

### Adjustable Air Vents

At least one air vent must be open while cooling is on in order to prevent the evaporator from icing up due to lack of air movement.

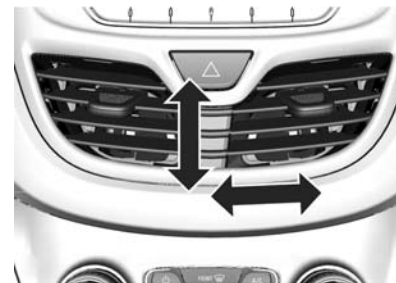

Direct the flow of air by tilting and swivelling the slats. If you do not want the flow, move the slats to inside for centre vent and outside for side vent. The vent has some air leakages at closed position.



## 136 Climate Controls

### Warning

Do not attach any objects to the slats of the air vents. Risk of damage and injury in case of an accident.

### Fixed Air Vents

Additional air vents are located beneath the windscreen and door windows and in the foot wells. These are fixed and cannot be adjusted.

## Maintenance

### Air Intake

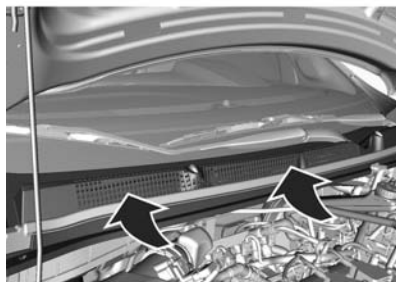

The air intake in front of the windscreen in the engine compartment must be kept clear to allow air intake. Remove any leaves, dirt or snow.

## Passenger Compartment Air Filter

### Cabin air filtration

The particle filter cleans the cabin air from solid particulates such as pollen, dust, soot from the air. The filter should be replaced as part of routine scheduled maintenance.

### Caution

More frequent maintenance of the air filter is required if the driving circumstances are dusty roads, air pollution areas, and frequent unpaved roads. It makes the filter efficiency to be decreased and the bronchus to be bad effected.

## **Air Conditioning Regular Operation**

In order to ensure continuously efficient performance, cooling must be operated for a few minutes once a month, irrespective of the weather and time of year. Operation with cooling is not possible when the outside temperature is too low.

## **Service**

For optimal cooling performance, it is recommended to annually check the climate control system.

- functionality and pressure test
- heating functionality
- leakage check
- check of drive belts
- cleaning of condenser and evaporator drainage
- performance check

## 138 Driving and Operating

### Driving and Operating

#### Driving Information

Control of a Vehicle .....	138
Steering .....	139

#### Starting and Operating

New Vehicle Run-In .....	139
Ignition Positions .....	139
Starting the Engine .....	140
Retained Accessory Power (RAP) .....	141
Automatic Engine Start/Stop Feature .....	141
Parking .....	143

#### Engine Exhaust

Engine Exhaust .....	144
Catalytic Converter .....	144

#### Manual Gearbox

Manual Gearbox .....	145
----------------------	-----

#### Brakes

Brakes .....	145
Antilock Brake System (ABS) .....	146

Parking Brake .....	146
Brake Assist .....	147
Hill Start Assist (HSA) .....	147

#### Ride Control Systems

Traction Control System (TCS) .....	147
Electronic Stability Control (ESC) .....	148

#### Object Detection Systems

Parking Assist (Rear parking assist) .....	150
--	-----

#### Driver Assistance Systems

Driver Assistance Systems ...	152
Cruise Control .....	152
Speed Limiter .....	153
Lane Departure Warning (LDW) .....	154

#### Fuel

Fuel (for Petrol Engines) .....	156
Filling the Tank .....	156
Fuel Consumption - CO2-Emissions .....	158

### Driving Information

#### Control of a Vehicle

##### Never coast with engine not running (except during Autostop)

Many systems will not function in this situation (e.g. brake servo unit, power steering). Driving in this manner is a danger to yourself and others.

##### Idle boost

If charging of the vehicle battery is required due to vehicle battery condition, the power output of the alternator must be increased. This will be achieved by an idle boost which may be audible.

##### Pedals

To ensure the pedal travel is uninhibited, there must be no mats in the area of the pedals.

## Steering

If power steering assist is lost because the engine stops or due to a system malfunction, the vehicle can be steered but may require a higher or lower steering effort.

Control indicator  *Variable Effort Steering Light* ⇨ 72.

### Caution

Vehicle equipped with electric power steering:

If the steering wheel is turned until it reaches the end of its travel and is held against that position for an extended period of time, power steering assist may be reduced.

If the steering assistance is used for an extended period of time, power assistance may be reduced.

Normal use of the power steering assist should return when the system cools down.

## Starting and Operating

### New Vehicle Run-In

Do not brake unnecessarily hard for the first few journeys.

During the first drive, smoke may occur because of wax and oil evaporating off the exhaust system. Park the vehicle in the open for a while after the first drive and avoid inhaling the fumes.

During the running-in period fuel and engine oil consumption may be higher.

Autostop may be inhibited to allow for charging the vehicle battery.

## Ignition Positions

### Ignition switch positions

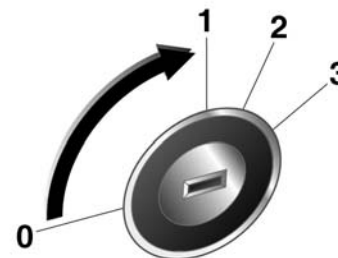

0 : Ignition off

1 : Steering wheel lock released, ignition off

2 : Ignition on

3 : Starting

## 140 Driving and Operating

### Starting the Engine

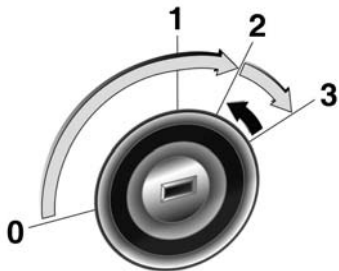

Manual gearbox: Operate clutch

Automatic transmission : Operate brake and move the selector lever to P or N

Do not operate accelerator pedal.

Turn the key briefly to position 3 and release : An automatic procedure operates the starter with a short delay as long as the engine is running, see Automatic Starter Control.

Before restarting or to switch off the engine, turn the key back to position 0.

During an Autostop, the engine can be started by depressing the clutch pedal.

#### Starting the vehicle at low temperatures

The start of the engine without additional heaters is possible down to -25 °C for diesel engines and -30 °C for petrol engines.

Diesel engines The start of the engine without additional heaters is possible down to -25 °C.

Petrol engines The start of the engine without additional heaters is possible down to -30 °C.

Required is an engine oil with the correct viscosity, the correct fuel, performed services and a sufficiently charged vehicle battery.

With temperatures below -30 °C, the automatic transmission requires a warming phase of approx. 5 minutes.

The selector lever must be in position P.

#### Automatic starter control

This function controls the engine starting procedure. The driver does not need to hold the key in position 3.

Once applied, the system will go on starting automatically until the engine is running. Because of the checking procedure, the engine starts running after a short delay.

Possible reasons for a non-starting engine:

- clutch pedal not operated (manual gearbox)
- time out occurred

#### Overrun cut-off

The fuel supply is automatically cut-off during overrun, i.e. when the vehicle is driven with a gear engaged but accelerator is released.

## Retained Accessory Power (RAP)

### Retained power off

The following electronic systems can work until the driver's door is opened or at the latest for 10 minutes after the ignition is switched off :

- power windows
- power outlets

Power to the Infotainment system will continue to operate for 30 minutes or until the key is removed from the ignition, regardless of whether any door will be opened.

## Automatic Engine Start/ Stop Feature

The stop-start system helps to save fuel. When conditions allow, it switches off the engine as soon as the vehicle is at a low speed or at a standstill, e.g. at a traffic light or in a traffic jam. It starts the engine automatically as soon as the clutch is depressed. A vehicle battery

sensor ensures that an Autostop is only performed if the vehicle battery is sufficiently charged for a restart.

### Activation

The stop-start system is available as soon as the engine is started, the vehicle starts-off and the conditions as stated below in this section are fulfilled.

### Deactivation



Deactivate the stop-start system manually by pressing the button. The deactivation is indicated by the LED in the button extinguishing.

## Autostop

If the vehicle is at a low speed or at a standstill, activate an Autostop as follows :

- depress the clutch pedal
- set the lever in neutral
- release the clutch pedal

The engine will be switched off while the ignition stays on.



An Autostop is indicated by the needle at the AUTOSTOP position in the tachometer.

## 142 Driving and Operating

During an Autostop, the heating and brake performance will be maintained.

### Conditions for an Autostop

The stop-start system checks if each of the following conditions is fulfilled.

- The stop-start system is not manually deactivated.
- The bonnet is fully closed.
- The driver's door is closed or the driver's seat belt is fastened.
- The vehicle battery is sufficiently charged and in good condition.
- The engine is warmed up.
- The engine coolant temperature is not too high.
- The engine exhaust temperature is not too high, e.g. after driving with high engine load.
- The ambient temperature is not too low.
- The defrost selection does not inhibit an Autostop.

- The climate control system allows an Autostop.
- The brake vacuum is sufficient.
- The vehicle has moved since the last Autostop.

Otherwise an Autostop will be inhibited.

An Autostop may become less available as the ambient temperature approaches the freezing point.

Certain settings of the climate control system may inhibit an Autostop. See Climate control chapter for more details.

Immediately after motorway driving an Autostop may be inhibited.

New vehicle running-in ⇨ *New Vehicle Run-In* ⇨ 139.

### Vehicle battery discharge protection

To ensure reliable engine restarts, several vehicle battery discharge protection features are implemented as part of the stop-start system.

### Power saving measures

During an Autostop, several electrical features such as auxiliary electric heater or rear window heating are disabled or switched into a power saving mode. The fan speed of the climate control system is reduced to save power.

### Restart of the engine by the driver

Depress the clutch pedal to restart the engine.

The engine start is indicated by the needle at the idle speed position in the tachometer.

If the selector lever is shifted out of neutral before depressing the clutch first, control indicator  illuminates or is shown as a symbol in the Driver Information Centre.

Control indicator  ⇨ *Control Indicators* ⇨ 66.

### Restart of the engine by the stop-start system

The selector lever must be in neutral to enable an automatic restart.

If one of the following conditions occurs during an Autostop, the engine will be restarted automatically by the stop-start system.

- The stop-start system is manually deactivated.
- The bonnet is opened.
- The driver's seat belt is unfastened and the driver's door is opened.
- The engine temperature is too low.
- The vehicle battery is discharged.
- The brake vacuum is not sufficient.
- The vehicle starts to move.
- The climate control system requests an engine start.

- The air conditioning is manually switched on.

If the bonnet is not fully closed, a warning message is displayed in the Driver Information Centre.

If an electrical accessory, e.g. a portable CD player, is connected to the power socket, a brief power drop during restart might be noticeable.

### Parking

#### Warning

- Do not park the vehicle on an easily ignitable surface. The high temperature of the exhaust system could ignite the surface.
- Always apply parking brake. Apply manual parking brake without pressing release button. Apply as firmly as possible on downhill or

(Continued)

#### Warning (Continued)

uphill slopes. Depress the foot brake at the same time to reduce operating force.

- Switch off the engine and ignition. Turn the steering wheel until the steering wheel lock engages.
- If the vehicle is on a level surface or uphill slope, engage first gear before switching off the ignition. On an uphill slope, turn the front wheels away from the kerb.

If the vehicle is on a downhill slope, engage reverse gear before switching off the ignition. Turn the front wheels towards the kerb.

(Continued)



## 144 Driving and Operating

### Warning (Continued)

- Lock the vehicle and activate the anti-theft alarm system.

**Note:** In the event of an accident with airbag deployment, the engine is turned off automatically if the vehicle comes to a standstill within a certain time.

### Engine Exhaust

#### Danger

Engine exhaust gases contain poisonous carbon monoxide, which is colourless and odourless and could be fatal if inhaled.

If exhaust gases enter the interior of the vehicle, open the windows. Have the cause of the fault rectified by a workshop.

Avoid driving with an open load compartment, otherwise exhaust gases could enter the vehicle.

### Catalytic Converter

The catalytic converter reduces the amount of harmful substances in the exhaust gases.

### Caution

Fuel grades other than those listed on pages ⇨ *Fuel (for Petrol Engines)* ⇨ 156, ⇨ *Engine Data* ⇨ 207 could damage the catalytic converter or electronic components.

Unburnt petrol will overheat and damage the catalytic converter. Therefore avoid excessive use of the starter, running the fuel tank dry and starting the engine by pushing or towing.

In the event of misfiring, uneven engine running, a reduction in engine performance or other unusual problems, have the cause of the fault rectified by a workshop as soon as possible. In an emergency, driving can be continued for a short period, keeping vehicle speed and engine speed low.

## Manual Gearbox

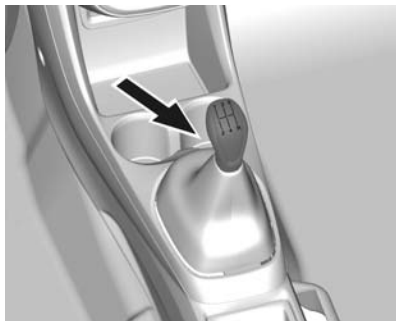

To engage reverse, depress the clutch pedal and then engage the reverse gear.

If the gear does not engage, set the lever to neutral, release the clutch pedal and depress again; then repeat gear selection.

Do not slip the clutch unnecessarily.

When operating, depress the clutch pedal completely. Do not use the pedal as a foot rest.

### Caution

It is not advisable to drive with the hand resting on the selector lever.

## Brakes

The brake system comprises two independent brake circuits.

If a brake circuit fails, the vehicle can still be braked using the other brake circuit. However, braking effect is achieved only when the brake pedal is depressed firmly. Considerably more force is needed for this. The braking distance is extended. Seek the assistance of a workshop before continuing your journey.

When the engine is not running, the support of the brake servo unit disappears once the brake pedal has been depressed once or twice. Braking effect is not reduced, but braking requires significantly greater force. It is especially important to bear this in mind when being towed.

Control indicator (⚠) ⇨ *Brake and Clutch System Warning Light* ⇨ 71.

## 146 Driving and Operating

### Antilock Brake System (ABS)

Anti-lock brake system (ABS) prevents the wheels from locking.

ABS starts to regulate brake pressure as soon as a wheel shows a tendency to lock. The vehicle remains steerable, even during hard braking.

ABS control is made apparent through a pulse in the brake pedal and the noise of the regulation process.

For optimum braking, keep the brake pedal fully depressed throughout the braking process, despite the fact that the pedal is pulsating. Do not reduce the pressure on the pedal.

After starting off, the system performs a self-test which may be audible.

Control indicator  ⇨ *Antilock Brake System (ABS) Warning Light* ⇨ 71.

### Adaptive brake light

During full braking, all three brake lights flash for the duration of ABS control.

#### Fault

#### **Warning**

If there is a fault in the ABS, the wheels may be liable to lock due to braking that is heavier than normal. The advantages of ABS are no longer available. During hard braking, the vehicle can no longer be steered and may swerve.

Have the cause of the fault remedied by a workshop.

### Parking Brake



#### **Warning**

Always apply parking brake firmly without operating the release button, and apply as firmly as possible on a downhill or uphill slope.

To release the parking brake, pull the lever up slightly, press the release button and fully lower the lever.

(Continued)

### Warning (Continued)

To reduce the operating forces of the parking brake, depress the foot brake at the same time.

See *Brake and Clutch System Warning Light* ⇨ 71.

## Brake Assist

If the brake pedal is depressed quickly and forcefully, maximum brake force is automatically applied (full braking).

Maintain continuous pressure on the brake pedal for as long as full braking is required. Maximum brake force is automatically reduced when the brake pedal is released.

## Hill Start Assist (HSA)

The system helps prevent unintended movement when driving away on inclines.

When releasing the foot brake after stopping on an incline, the brakes remain on for a further two seconds.

The brakes release automatically as soon as the vehicle begins to accelerate.

The hill start assist is not active during an Autostop.

## Ride Control Systems

### Traction Control System (TCS)

The Traction Control system (TC) is a component of the Electronic Stability Control system.

TC improves driving stability when necessary, regardless of the tyre of road surface or tyre grip, by preventing the drive wheels from spinning.

As soon as the drive wheels starts to spin, engine output is reduced and the wheel spinning the most is braked individually. This considerably improves the driving stability of the vehicle on slippery road surfaces.

TC is operational as soon as the control indicator  extinguishes.

When TC is active  flashes.

## 148 Driving and Operating

### Warning

Do not let this special safety feature tempt you into taking risks when driving.

Adapt speed to the road conditions.

Control indicator  ⇨ *Electronic Stability Control (ESC) Indicator Light* ⇨ 72.

### Deactivation

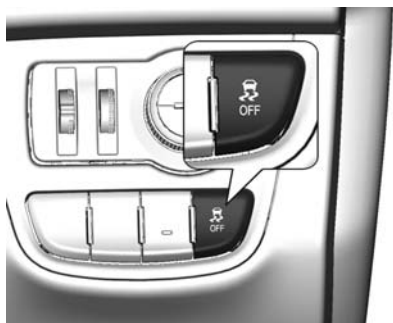

TC can be switched off when spinning of drive wheels is required : Press  briefly.

Control indicator  illuminates.

TC is reactivated by pressing  again.

TC is also reactivated the next time the ignition is switched on.

### Fault

If there is a fault in the system the control indicator  illuminates continuously and a message or a warning code appears in the Driver Information Centre. The system is not operational.

Have the cause of the fault remedied by a workshop.

### Electronic Stability Control (ESC)

Electronic Stability Control (ESC) improves driving stability when necessary, regardless of the type of road surface or tyre grip. It also prevents the drive wheels from spinning.

As soon as the vehicle starts to swerve (understeer/oversteer), engine output is reduced and the wheels are braked individually. This considerably improves the driving stability of the vehicle on slippery road surfaces.

ESC is operational as soon as the control indicator  extinguishes.

When ESC is active  flashes.

### Warning

Do not let this special safety feature tempt you into taking risks when driving.

Adapt speed to the road conditions.

Control indicator  ⇨ *Electronic Stability Control (ESC) Indicator Light* ⇨ 72.

## Deactivation

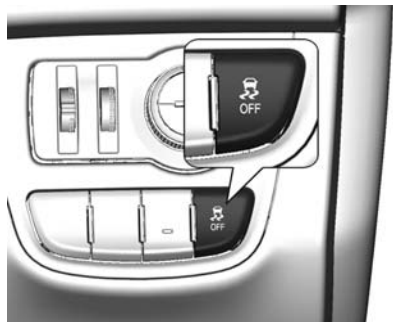

For very high-performance driving ESC can be deactivated : Hold  depressed for approx. 5 seconds.

Control indicator  illuminates.

ESC is reactivated by pressing  again. If the TC system was previously disabled, both TC and ESC are reactivated.

ESC is also reactivated the next time the ignition is switched on.

## Fault

If there is a fault in the system the control indicator  illuminates continuously and a message or a warning code appears in the Driver Information Centre. The system is not operational.

Have the cause of the fault remedied by a workshop.

## City mode

City mode is a feature which enables increased steering assistance during lower speed conditions, e.g. city traffic or parking. Steering assistance is increased for greater convenience.

## Activation



Press "CITY" when engine is running. The system works from standstill up to 37 mph, and in reverse gear. Above this speed the system changes to normal mode. When activated, City mode engages automatically below 37 mph.

An illuminated LED in the City mode button indicates that the system is active.

## 150 Driving and Operating

### Deactivation

Press **CITY**: LED in the button extinguishes.

Each time the engine is started, City mode is deactivated.

### Overload

If the steering in City mode is heavily loaded, e.g. in long parking manoeuvres or heavy city traffic, the system is deactivated for overheat protection. Steering operates in normal mode until City mode activates automatically.

### Fault

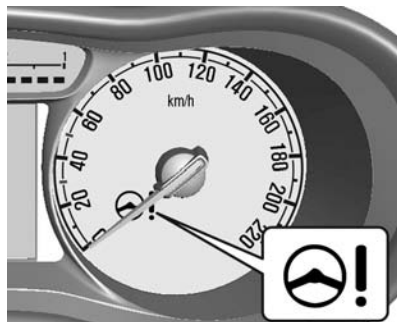

In the event of a fault in the system,  illuminates and a message is displayed in the Driver Information Centre.

Vehicle messages ⇨ *Vehicle Messages* ⇨ 80.

## Object Detection Systems

### Parking Assist (Rear parking assist)

#### Warning

It is the driver who bears full responsibility for the parking manoeuvre.

Always check the surrounding area while reversing and using the rear parking assist system.

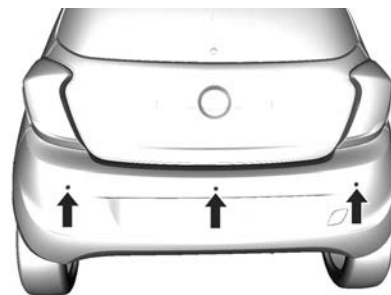

The rear parking assist makes parking easier by measuring the distance between the vehicle and rear obstacles. It informs and warns the driver by giving acoustic signals and display indication.

The system has three ultrasonic parking sensors in the rear bumper.

**Note:** The attached parts in the detection area cause system malfunction.

### Activation

When reverse gear is engaged, the system is activated automatically. An obstacle is indicated by audio.

The interval between the audios becomes shorter as the vehicle gets closer to the obstacle. When the distance is less than 40 cm, the audio sounds continue.

### Warning

Under certain circumstances, various reflective surfaces on objects or clothing as well as  
(Continued)

### Warning (Continued)

external noise sources may cause the system to fail to detect obstacles. Special attention has to be paid to low obstacles which can damage the lower part of the bumper.

### Deactivation

The system automatically switches off when reverse gear is disengaged.

The system might not detect the obstacle when the vehicle is driven above a 6 mph.

### Fault

In the event of a fault in the system,  illuminates.

Additionally if the system does not work due to temporary conditions like snow covered sensors,  illuminates.

### Caution

Performance of the system can be reduced when sensors are covered, e.g. by ice or snow.

Performance of the parking assist system can be reduced due to heavy loading.

Special conditions apply if there are taller vehicles involved in the parking scene (e.g. off-road vehicles, MPVs, vans, campers, trailers and trucks). Object identification and correct distance indication in the upper part of these vehicles cannot be guaranteed.

Objects with a very small reflection cross section, like objects of narrow size or soft materials, may not be detected by the system.

Parking assist will not detect objects out of the detection range.



## 152 Driving and Operating

### Driver Assistance Systems

#### Warning

Driver assistance systems are developed to support the driver and not to replace the driver's attention.

The driver accepts full responsibility when driving the vehicle.

When using driver assistance systems, always take care regarding the current traffic situation.

### Cruise Control

The cruise control can store and maintain speeds of approx. 15 to 106 mph. Deviations from the stored speeds may occur when driving uphill or downhill.

For safety reasons, the cruise control cannot be activated until the foot brake has been operated once.

Activating in first gear is not possible.

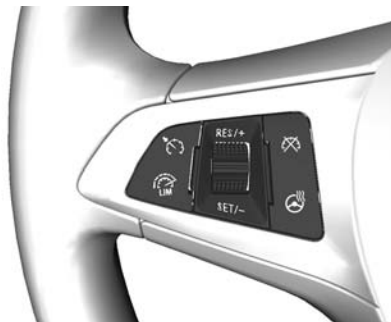



Do not use the cruise control if it is not advisable to maintain a constant speed.

Control indicator  *Control Indicators* ⇨ 66.

#### Switching on



Press ; control indicator  in instrument cluster illuminates white.

#### Activation

Accelerate to the desired speed and turn thumb wheel to **SET/-**, the current speed is stored and maintained. Control indicator  in instrument cluster illuminates green. Accelerator pedal can be released.

Vehicle speed can be increased by depressing the accelerator pedal. When the accelerator pedal is released, the previously stored speed is resumed.

Cruise control remains activated while changing gear.

#### Increase speed

With cruise control active, hold thumb wheel turned to **RES/+** or briefly turn to **RES/+** repeatedly: speed increases continuously or in small increments.

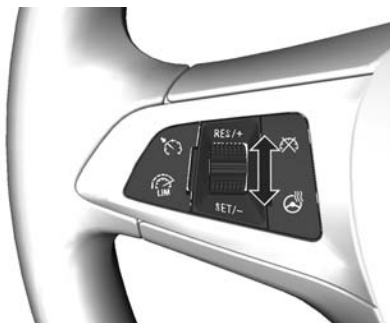

Alternatively accelerate to the desired speed and store by turning to **SET/-**.



### Reduce speed

With cruise control active, hold thumb wheel turned to **SET/-** or briefly turn to **SET/-** repeatedly: speed decreases continuously or in small increments.

### Deactivation

Press ; control indicator  in instrument cluster illuminates white. Cruise control is deactivated. Last used set speed is stored in memory for later speed resume.

Automatic deactivation:



- Vehicle speed is below approx. 15 mph.

- The brake pedal is depressed.
- The clutch pedal is depressed for a few seconds.
- The selector lever is in neutral.
- Engine speed is in a very low range.
- The Traction Control system or Electronic Stability Control is operating.

### Resume stored speed

Turn thumb wheel to **RES/+** at a speed above 15 mph. The stored speed will be obtained.

### Switching off

Press , control indicator  in instrument cluster extinguishes. The stored speed is deleted.

Pressing  to activate the speed limiter or switching off the ignition also switches off cruise control and deletes the stored speed.

## Speed Limiter

The speed limiter prevents the vehicle exceeding a preset maximum speed.

The maximum speed can be set at a speed above 18 mph.



The driver can only accelerate up to the preset speed. Deviations from the limited speed may occur when driving downhill.

The preset speed limit is displayed in the Driver Information Centre (DIC) when the system is active.

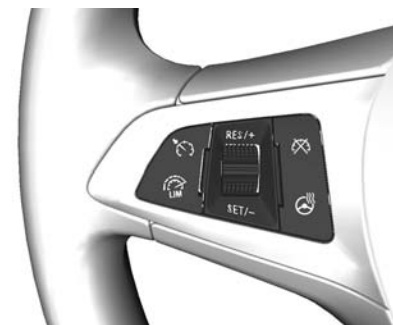
### Activation



## 154 Driving and Operating

Press . If cruise control has been activated before, it is switched off when speed limiter is activated and control indicator  extinguishes.

### Set speed limit

With speed limiter active, hold thumb wheel turned to **RES/+** or briefly turn to **RES/+** repeatedly until the desired maximum speed is displayed in the DIC.

Alternatively, accelerate to the desired speed and briefly turn thumb wheel to **SET/-**: the current speed is stored as maximum speed. Speed limit is displayed in the DIC.



### Change speed limit

With speed limiter active, turn thumb wheel to **RES/+** to increase or **SET/-** to decrease the desired maximum speed.

### Exceeding the speed limit

In the event of an emergency, it is possible to exceed the speed limit by depressing the accelerator pedal firmly beyond the point of resistance. The limited speed will flash in the DIC and a chime sounds during this period.

Release the accelerator pedal and the speed limiter function is reactivated once a speed lower than the limit speed is obtained.

### Deactivation

Press : speed limiter is deactivated and the vehicle can be driven without speed limit.

The limited speed will be stored and is indicated in brackets in the DIC. Additionally, a corresponding message appears.

### Resume limit speed

Turn thumb wheel to **RES/+**. The stored speed limit will be obtained.

### Switching off

Press , the speed limit indication extinguishes in the DIC. The stored speed is deleted.

By pressing  to activate cruise control, speed limiter is also deactivated and the stored speed is deleted.

By switching off the ignition, speed limiter is also deactivated, but the speed limit will be stored for next speed limiter activation.

### Lane Departure Warning (LDW)

The lane departure warning system observes the lane markings between which the vehicle is driving, via a front camera. The system detects lane changes and warns the driver in the event of an unintended lane change by visual and acoustic signals.

Criteria for the detection of an unintended lane change are :

- no operation of indicators

- no brake pedal operation
- no active accelerator operation or speeding-up
- no active steering

If the driver is active, no warning will be issued.

### Activation



The lane departure warning system is activated by pressing the . The illuminated LED in the button indicates that the system is switched on. When the control

indicator  in the instrument cluster illuminates green, the system is ready to operate.

The system is only operable at vehicle speeds above 35 mph and if lane markings are available.

When the system recognises an unintended lane change, the control indicator  changes to yellow and flashes. Simultaneously a chime sound is activated.



### Deactivation

The system is deactivated by pressing ; the LED in the button extinguishes.

At speeds below 35 mph the system is inoperable.

### Fault

The lane departure warning system may not operate properly when :

- The windscreen is not clean.
- There are adverse environmental conditions, e.g. heavy rain, snow, direct sunlight or shadows.

The system cannot operate when no lane marking is detected.

## 156 Driving and Operating

### Fuel

#### Fuel (for Petrol Engines)

Only use unleaded fuel that complies with European standard EN 228 or E DIN 51626-1 or equivalent.

Your engine is capable of running with E10 fuel that fulfils these standards. E10 fuel contains up to 10% bioethanol.

Use fuel with the recommended octane rating ⇨ *Engine Data* ⇨ 207. Use of fuel with too low an octane rating can reduce engine power and torque and slightly increases fuel consumption.

#### Caution

Do not use fuel or fuel additives that contain metallic compounds such as manganese-based additives. This may cause engine damage.

#### Caution

Use of fuel that does not comply to EN 228 or E DIN 51626-1 or equivalent can lead to deposits or engine damage and loss of warranty.

#### Caution

Use of fuel with too low an octane rating could lead to uncontrolled combustion and engine damage.

### Filling the Tank

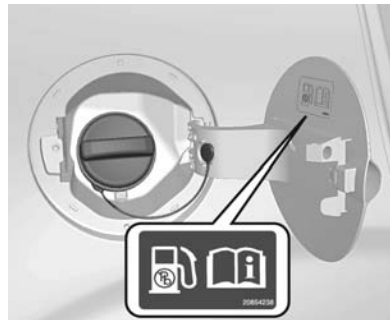

#### Danger

Before refuelling, switch off engine and any external heaters with combustion chambers. Switch off any mobile phones.

Follow the operating and safety instructions of the filling station when refuelling.

**⚠ Danger**

Fuel is flammable and explosive.  
No smoking. No naked flames or  
sparks.

If you can smell fuel in your  
vehicle, have the cause of this  
remedied immediately by a  
workshop.

**Caution**

In case of misfuelling, do not  
switch on ignition.



1. Stop the engine.
2. Pull up on fuel filler door release lever located on the floor, right front side of driver's seat.
3. Turn the fuel filler cap anticlockwise slowly. If a hissing sound is heard, wait for it to stop before completely unscrewing the cap. The fuel filler door is in the right rear quarter panel.

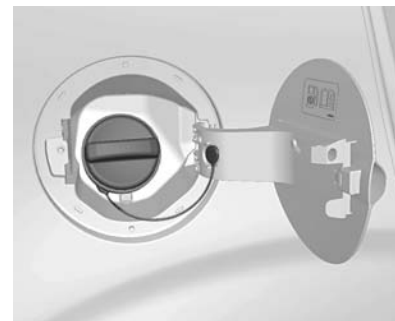

4. Remove the cap. The cap is tethered to the vehicle.
5. After refuelling, replace cap. Turn it clockwise until you hear several clicks.
6. Push the fuel filler door closed until it latches.

**Note:** If, in cold weather, the fuel filler door does not open, tap the door lightly. Then try to open it again.

**Caution**

Wipe off any overflowing fuel immediately.

## 158 Driving and Operating

---

### **Fuel Consumption - CO<sub>2</sub>-Emissions**

The fuel consumption (combined) of the model Opel Karl is within a range of to 52 to 58 mpg.

The CO<sub>2</sub> emission (combined) is within a range of 104 to 99 g/km.

For the values specific for your vehicle, refer to the EEC Certificate of Conformity provided with your vehicle or other national registration documents.

### **General information**

The official fuel consumption and specific CO<sub>2</sub> emission figures quoted relate to the EU base model with standard equipment.

Fuel consumption data and CO<sub>2</sub> emission data are determined according to regulation R (EC) No.

715/2007 (in the version respectively applicable), taking into consideration the vehicle weight in running order, as specified by the regulation.

The figures are provided only for the purpose of comparison between different vehicle variants and must not be taken as a guarantee for the actual fuel consumption of a particular vehicle. Additional equipment may result in slightly higher results than the stated consumption and CO<sub>2</sub> figures.

Furthermore, fuel consumption is dependent on personal driving style as well as road and traffic conditions.

## Vehicle Care

### General Information

Accessories and Modifications .....	160
Vehicle Storage .....	160
End-of-Life Vehicle Recovery .....	161

### Vehicle Checks

Doing Your Own Service Work .....	161
Bonnet .....	161
Engine Oil .....	162
Engine Coolant .....	163
Washer Fluid .....	164
Brakes .....	164
Brake Fluid .....	164
Battery .....	164
Wiper Blade Replacement ....	166

### Bulb Replacement

Bulb Replacement .....	167
Headlamps and Parking Lamps .....	167
Fog Lamps .....	169
Front Indicator Lamps .....	169
Taillights .....	169
Side Indicator Lamps .....	171

Centre High-Mounted Brake lamp (CHMBL) .....	171
Number Plate Lamp .....	172
Interior Lamps .....	172
Instrument Panel Illumination .....	172

### Electrical System

Fuses .....	173
Engine Compartment Fuse Block .....	174
Instrument Panel Fuse Block .....	176

### Vehicle Tools

Tools .....	177
-------------	-----

### Wheels and Tyres

Wheels and Tyres .....	178
Winter Tyres .....	178
Tyre Designations .....	178
Tyre Pressure .....	179
Tyre Pressure Monitor System .....	180
Tread Depth .....	183
Wheel Covers .....	184
Tyre Chains .....	184
Tyre Repair Kit .....	184
Tyre Changing .....	188
Compact Spare Tyre .....	191

### Jump Starting

Jump Starting .....	192
---------------------	-----

### Towing the Vehicle

Towing the Vehicle .....	194
--------------------------	-----

### Appearance Care

Exterior Care .....	195
Interior Care .....	197



## 160 Vehicle Care

### General Information

#### Accessories and Modifications

We recommend the use of genuine parts and accessories and factory approved parts specific for your vehicle type. We cannot assess or guarantee reliability of other products - even if they have a regulatory or otherwise granted approval.

Do not make any modifications to the electrical system, e.g. changes of electronic control units (chip tuning).

#### Caution

When transporting the vehicle on a train or on a recovery vehicle, the mud flaps might be damaged.

### Vehicle Storage

#### Storage for a long period of time

If the vehicle is to be stored for several months :

- Wash and wax the vehicle.
- Have the wax in the engine compartment and underbody checked.
- Clean and preserve the rubber seals.
- Fill up fuel tank completely.
- Change the engine oil.
- Drain the washer fluid reservoir.
- Check the coolant antifreeze and corrosion protection.
- Adjust tyre pressure to the value specified for full load.
- Park the vehicle in a dry, well ventilated place. Engage first or reverse gear. Prevent the vehicle from rolling.
- Do not apply the parking brake.

- Open the bonnet, close all doors and lock the vehicle.
- Disconnect the clamp from the negative terminal of the vehicle battery. Beware that all systems are not functional, e.g. anti-theft alarm system.

#### Putting back into operation

When the vehicle is to be put back into operation :

- Connect the clamp to the negative terminal of the vehicle battery. Activate the electronics of the power windows.
- Check tyre pressure.
- Fill up the washer fluid reservoir.
- Check the engine oil level.
- Check the coolant level.
- Fit the number plate if necessary.

## End-of-Life Vehicle Recovery

Information on end-of-life vehicle recovery centres and the recycling of end-of-life vehicles is available on our website. Only entrust this work to an authorised recycling centre.

Gas vehicles must be recycled by a service centre authorised for gas vehicles.

## Vehicle Checks

### Doing Your Own Service Work

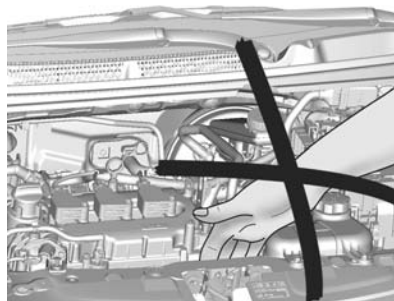

#### Warning

Only perform engine compartment checks when the ignition is off.

The cooling fan may start operating even if the ignition is off.

#### Danger

The ignition system uses extremely high voltage. Do not touch.

## Bonnet

### Opening

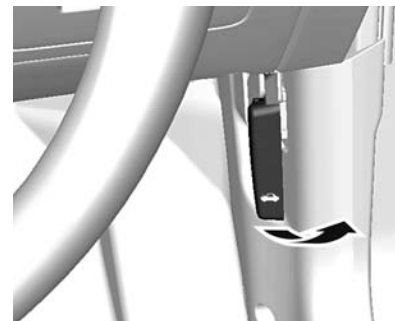

Pull the release lever and return it to its original position.

## 162 Vehicle Care



Push the safety catch and open the bonnet.

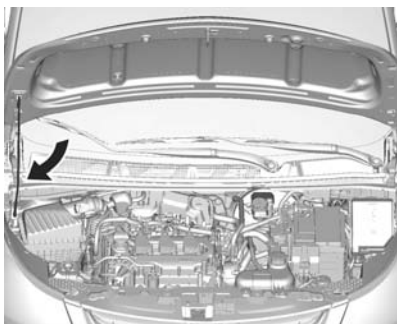

Secure the bonnet support.

If the bonnet is opened during an Autostop, the engine will be restarted automatically for safety reasons.

### Closing

Before closing the bonnet, press the support into the holder. Lower the bonnet and allow it to fall into the latch from a low height (20-25 cm). Check that the bonnet is engaged.

### Caution

Do not press the bonnet into the latch, to avoid dents.

### Engine Oil

Check the engine oil level manually on a regular basis to prevent damage to the engine.

Ensure that the correct specification of oil is used. Recommended fluids and lubricants ⇨ *Recommended Fluids and Lubricants* ⇨ 200.

Check with the vehicle on a level surface. The engine must be at operating temperature and switched off for at least 5 minutes.

Pull out the dipstick, wipe it clean, insert it to the stop on the handle, pull out and read the engine oil level.

Insert dipstick to the stop on the handle and make half a turn.

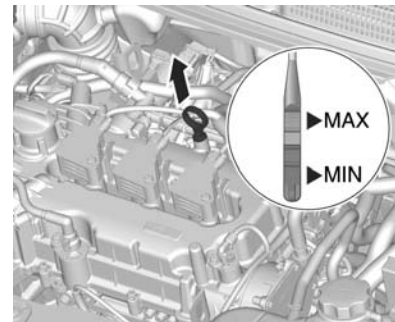

When the engine oil level has dropped to the MIN mark, top up engine oil.

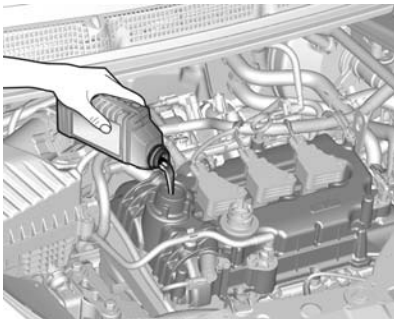

We recommend the use of the same grade of engine oil that was used at last change.

The engine oil level must not exceed the **MAX** mark on the dipstick.

### Caution

Overfilled engine oil must be drained or suctioned out.

Capacities ⇨ *Capacities and Specifications* ⇨ 209.

Fit the cap on straight and tighten it.

## Engine Coolant

The coolant provides freeze protection down to approx.  $-28^{\circ}\text{C}$ .

In northern countries with very low temperatures the factory filled coolant provides frost protection down to approx.  $-37^{\circ}\text{C}$ .

### Caution

Only use approved antifreeze.

## Coolant level

### Caution

Too low a coolant level can cause engine damage.

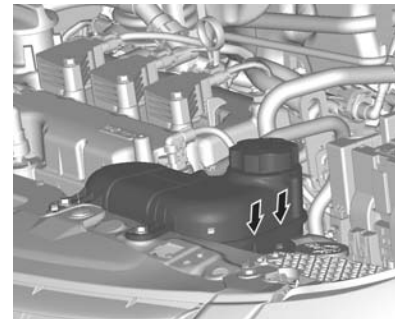

If the cooling system is cold, the coolant level should be above the filling line mark.

### ⚠ Warning

Allow the engine to cool before opening the cap. Carefully open the cap, relieving the pressure slowly.

To top up use a 1:1 mixture of released coolant concentrate mixed with clean tap water. If no coolant concentrate is available, use clean tap water. Install the cap tightly. Have the coolant concentration

## 164 Vehicle Care

checked and have the cause of the coolant loss remedied by a workshop.

### Washer Fluid

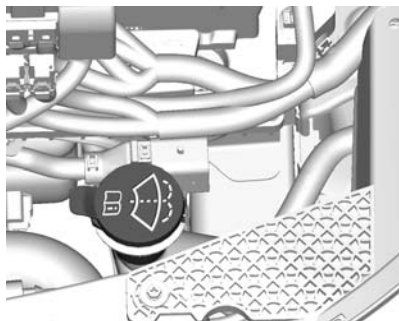

Fill with clean water mixed with a suitable quantity of washer fluid which contains antifreeze.

#### Caution

Only washer fluid with a sufficient antifreeze concentration provides protection at low temperatures or a sudden drop in temperature.

(Continued)

#### Caution (Continued)

Use of washer fluid containing isopropanol can damage exterior lamps.

### Brakes

In the event of minimum thickness of the brake lining, a squealing noise sounds during braking.

Continued driving is possible but have the brake lining replaced as soon as possible.

Once new brake linings are installed, do not brake unnecessarily hard for the first few journeys.

### Brake Fluid

#### Warning

Brake fluid is poisonous and corrosive. Avoid contact with eyes, skin, fabrics and painted surfaces.



The brake fluid level must be between the **MIN** and the **MAX** marks.

If fluid level is below the **MIN** mark, seek the assistance of a workshop.

Brake and clutch fluid ⇨  
*Recommended Fluids and  
Lubricants* ⇨ 200.

### Battery

Vehicles without stop-start system will be equipped with a lead acid battery. Vehicles with stop-start system will be equipped with an AGM battery which is not a lead acid battery.

The vehicle battery is maintenance-free provided that the driving profile allows sufficient charging of the battery. Short-distance-driving and frequent engine starts can discharge the battery. Avoid the use of unnecessary electrical consumers.



Batteries do not belong in household waste. They must be disposed of at an appropriate recycling collection point.

Laying up the vehicle for more than 4 weeks can lead to battery discharge. Disconnect the clamp from the negative terminal of the vehicle battery.

Ensure the ignition is switched off before connecting or disconnecting the vehicle battery.

### Replacing the vehicle battery

**Note:** Any deviation from the instructions given in this paragraph may lead to a temporary deactivation of the stop-start system.

When the vehicle battery is being replaced, please ensure that there are no open ventilation holes in the vicinity of the positive terminal. If a ventilation hole is open in this area, it must be closed off with a dummy cap, and the ventilation in the vicinity of the negative terminal must be opened.

Only use vehicle batteries that allow the fuse box to be mounted above the vehicle battery.

In vehicles with stop-start system, ensure to have the AGM (Absorptive Glass Mat) battery replaced with an AGM battery again.



An AGM battery can be identified by the label on the battery. We recommend the use of an original Vauxhall vehicle battery.

**Note:** Using an AGM vehicle battery different from the original Vauxhall vehicle battery may result in a lower performance of the stop-start system.

We recommend that you have the vehicle battery replaced by a workshop. Stop-start system ⇨ *Automatic Engine Start/Stop Feature* ⇨ 141.

## 166 Vehicle Care

### Charging the vehicle battery

#### **Warning**

On vehicles with stop-start system, ensure that the charging potential does not exceed 14.6 volts when using a battery charger. Otherwise the vehicle battery might be damaged.

Jump starting ⇨ *Jump Starting* ⇨ 192.

#### **Warning label**



Meaning of symbols:

- No sparks, naked flames or smoking.
- Always shield eyes. Explosive gases can cause blindness or injury.
- Keep the vehicle battery out of reach of children.
- The vehicle battery contains sulphuric acid which could cause blindness or serious burn injuries.
- See the Owner's Manual for further information.
- Explosive gas may be present in the vicinity of the vehicle battery.

### Wiper Blade Replacement

#### Wiper blades on the windscreen



Lift wiper arm. Press release lever and detach wiper blade.

Attach the wiper blade slightly angled to the wiper arm and push until it engages.

Lower wiper arm carefully.

### Wiper blade on the rear window



Lift wiper arm. Push the wiper blade, slightly angled to the wiper arm, downwards until it disengages.

Attach the wiper blade, slightly angled to the wiper arm, and push until it engages.

Lower wiper arm carefully.

### Bulb Replacement

Switch off the ignition and switch off the relevant switch or close the doors.

Only hold a new bulb at the base! Do not touch the bulb glass with bare hands.

Use only the same bulb type for replacement.

Replace headlamp bulbs from within the engine compartment.

#### Bulb check

After a bulb replacement switch on the ignition, operate and check the lights.

### Headlamps and Parking Lamps

#### Dipped beam and main beam

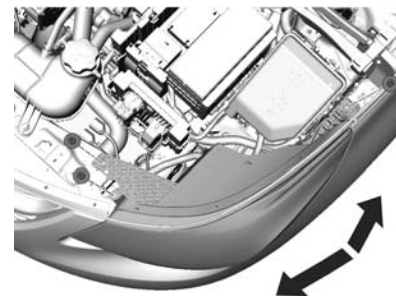

1. Unscrew the three screws.
2. Carefully withdraw the headlight assembly from retaining pins and remove as shown in illustration and remove, make sure that cable duct remains in position.
3. Detach plug connector from bulb.



## 168 Vehicle Care

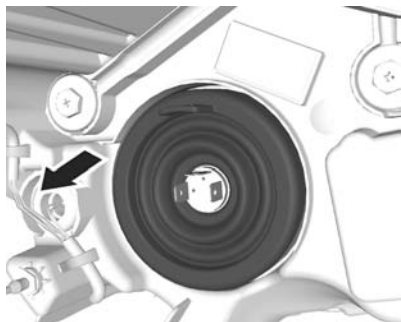

4. Remove protective cover.



5. Press spring clip, disengage it.

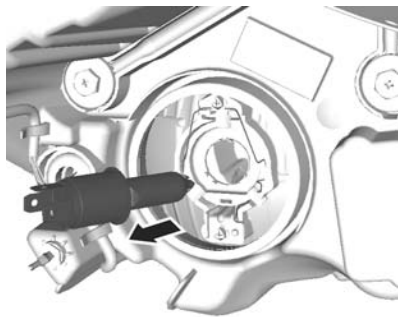

6. Remove bulb from reflector housing.

7. When fitting a new bulb, engage the lugs in the recesses on the reflector.

8. Engage the spring clip.

9. Place headlight protective cover in position and close.

## Parking/Daytime running light

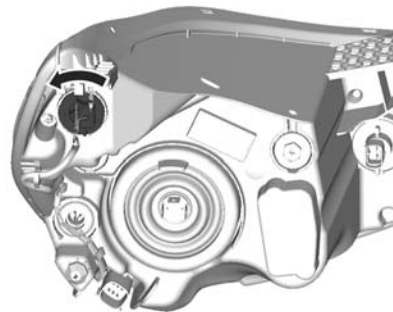

1. Rotate the bulb holder anticlockwise and remove it.

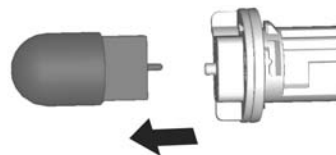

2. Detach bulb from the bulb holder and replace it.
3. Insert the bulb holder into the reflector and rotate clockwise.

## Fog Lamps

Have bulbs replaced by a workshop.

## Front Indicator Lamps

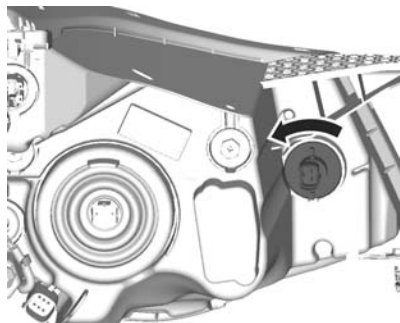

1. Rotate the bulb holder anticlockwise and remove it.

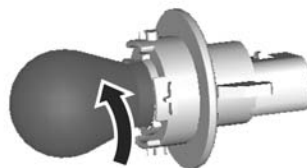

2. Rotate bulb anticlockwise and remove from bulb holder.
3. Replace bulb.
4. Insert the bulb holder into the reflector and rotate clockwise.

## Taillights

### Tail lights, indicator, brake lamps, and reversing lamps



1. Unscrew both screws.
2. Remove tail light assembly. Take care that the cable duct remains in position.

## 170 Vehicle Care

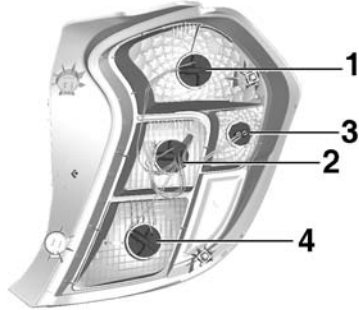

3. Tail light/brake lamp (1)  
Indicator lamp (2)  
Auxiliary Tail light (3)  
Reversing lamp (Passenger's side)/Rear fog lamp(Driver's side) (4).

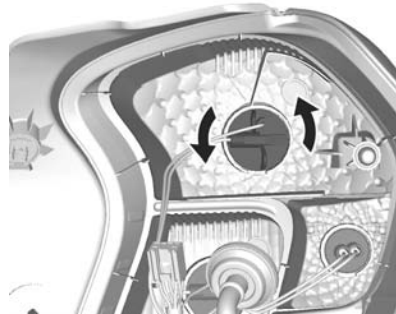

4. Rotate bulb holder anticlockwise.

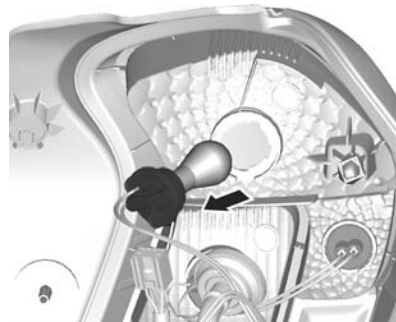

5. Remove bulb holder. Push bulb into socket slightly, rotate anti-clockwise, remove and renew bulb.
6. Insert bulb holder into the tail light assembly and screw into place.  
  
Connect wiring plug. Install tail light assembly in body and tighten screws. Close covers and engage.
7. Switch on ignition, operate and check all lights.

## Side Indicator Lamps

To replace bulb, remove lamp housing :

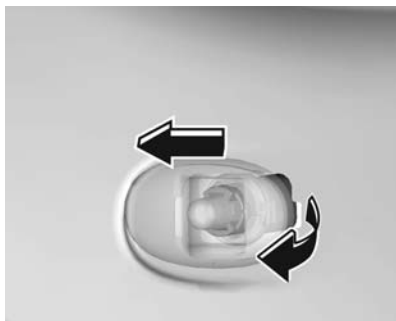

1. Slide lamp to the front and remove it out of the front wing with the rear end.



2. Turn bulb holder anticlockwise and remove from housing.

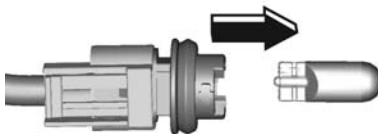

3. Pull bulb from bulb holder and replace it.

4. Insert bulb holder and turn clockwise.
5. Insert front end into front wing, slide forward and insert rear end.

## Centre High-Mounted Brake lamp (CHMBL)



Have LEDs replaced by a workshop.

## 172 Vehicle Care

### Number Plate Lamp

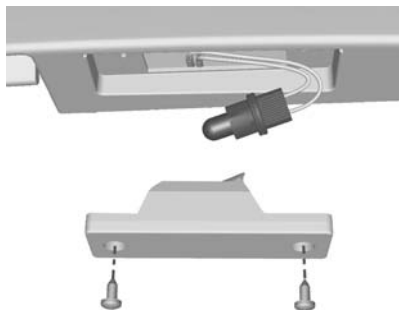

1. Unscrew both screws.
2. Remove bulb housing downward, taking care not to pull on the cable.  
Rotate bulb holder anticlockwise to disengage.
3. Remove bulb from holder and renew bulb.
4. Insert bulb holder in bulb housing and rotate clockwise.
5. Insert bulb housing and secure using a screwdriver.

### Interior Lamps

#### Courtesy lamps

1. To remove, prise the opposite side of the lamp switch using a flat-blade screwdriver. (Be careful not to make scratches.)
2. Remove the bulb.
3. Replace the bulb.
4. Reinstall the lamp assembly.

#### Load compartment lamp

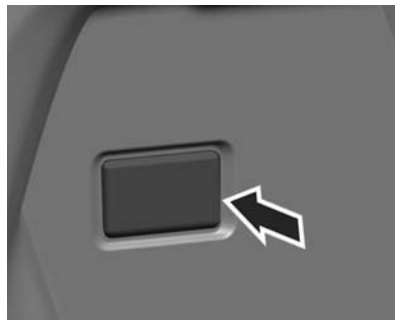

1. Prise the lamp out with a screwdriver.



2. Remove bulb.
3. Insert new bulb.
4. Install lamp.

### Instrument Panel Illumination

Have bulbs replaced by a workshop.

## Electrical System

### Fuses

Data on the replacement fuse must match the data on the defective fuse. There are three fuse boxes in the vehicle :

- In the front left of the engine compartment
- In left-hand drive vehicles, in the interior behind the storage compartment, or, in right-hand drive vehicles, behind the glovebox
- Behind a cover on the left side of the load compartment

Before replacing a fuse, turn off the respective switch and the ignition.

A blown fuse can be recognised by its melted wire. Do not replace the fuse until the cause of the fault has been remedied.

Some functions are protected by several fuses.

Fuses may also be inserted without existence of a function.

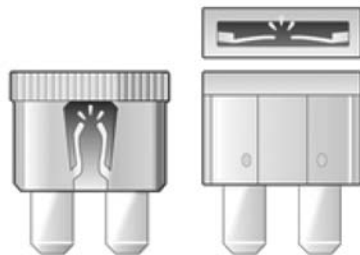

### Fuse extractor

A fuse extractor may be located in the fuse box in the engine compartment.

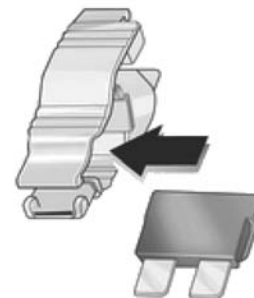
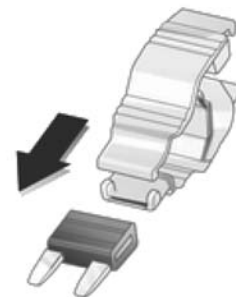

## 174 Vehicle Care



Place the fuse extractor on the various types of fuse from the top or side, and withdraw fuse.

### Engine Compartment Fuse Block

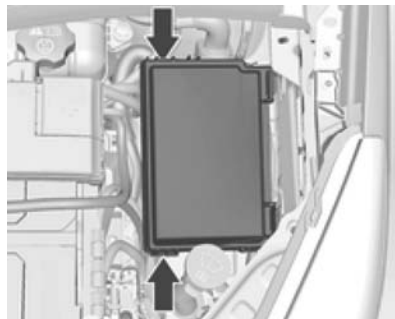

The fuse box is in the front left of the engine compartment.

Disengage the cover, lift it upwards and remove.

After having changed defective fuses close the fuse box cover and press until it engages.

If the fuse box cover is not closed correctly, malfunctions may occur.

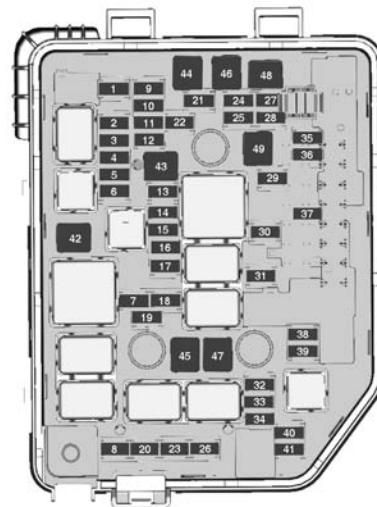

No. Circuit

- |   |                |
|---|----------------|
| 1 | Tailgate latch |
| 2 | -              |

3	Rear demist	20	Air conditioning system	38	Washer pump motor
4	Outside rear-view mirror heater	21	Intelligent battery sensor	39	Cornering lamp right
5	Sunroof	22	Electric steering column lock	40	-
6	Continuously Variable transmission control module	23	Cooling fan low	41	-
7	Mass air flow sensor	24	-	42	Starter 2
8	Auxiliary heater pump	25	Outside rear-view mirror switch	43	In-panel bussed electric centre
9	Anti-lock brake system valve	26	Engine control module/ Automated manual gearbox module	44	Automated manual gearbox
10	Regulated voltage control	27	Canister vent solenoid	45	Starter 1
11	Rear view camera	28	Brake pedal switch	46	Anti-lock brake system pump
12	-	29	Auxiliary occupant sensing	47	Cooling fan hi
13	-	30	Headlight levelling motor	48	Front wiper motor
14	Engine control module/ Transmission control module	31	Horn	49	In-panel bussed electric centre accessory/RAP power
15	Fuel injection control module/Starter	32	Front fog lamp		
16	Fuel pump motor	33	Main beam left		
17	Engine control module1	34	Main beam right		
18	Engine control module2	35	-		
19	Injector, Ignition	36	Rear wiper motor		
		37	Cornering lamp left		



## 176 Vehicle Care

### Instrument Panel Fuse Block

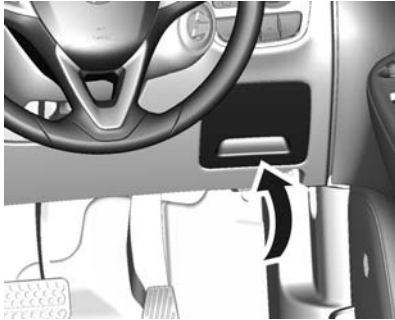

In right-hand drive vehicles, the fuse box is behind the storage compartment in the instrument panel.

Open compartment, compress the locking tabs, fold compartment down and remove.

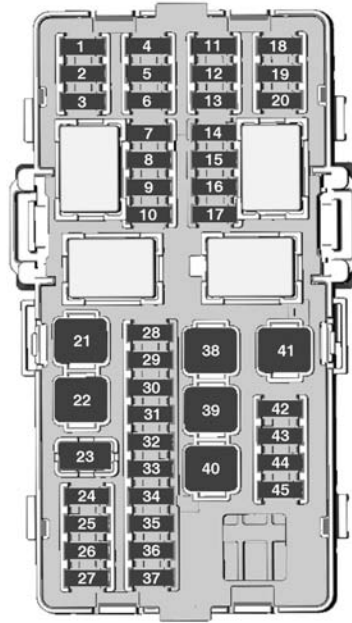

No.	Circuit
1	Onstar
2	HVAC module

- 3 Instrument panel cluster
- 4 Continuously Variable transmission control module
- 5 Radio
- 6 Body control module 1 (CVT Stop & Start)
- 7 Side blind spot alert/Rear parking assist
- 8 Data link connection
- 9 Electric steering column lock
- 10 Sensing and Diagnostic module
- 11 DC-DC converter
- 12 -
- 13 Electronic toll collection system
- 14 Linear power module
- 15 Passive entry & passive start
- 16 Discrete logic ignition switch (Non CVT stop&start)
- 17 Front collision avoidance

- |    |  |    |   |
|----|--|----|---|
| 18 | Instrument panel cluster                     | 36 | Discrete logic ignition switch (CVT stop&start) |
| 19 | Reflected LED Alert Display                  | 37 | Steering wheel controls backlighting            |
| 20 | Headlight levelling switch                   | 38 | -   |
| 21 | Front power window                           | 39 | Logistic/DC-DC converter                        |
| 22 | Rear power window                            | 40 | Driver express power window                     |
| 23 | -  | 41 | Blower motor                                    |
| 24 | Automated manual gearbox module              | 42 | Front heated seat                               |
| 25 | Auxiliary power socket                       | 43 | HVAC module                                     |
| 26 | Sunroof                                      | 44 | Heated steering wheel                           |
| 27 | -  | 45 | Body control module 2 (CVT Stop & Start)        |
| 28 | Body control module 8                        |    |   |
| 29 | Body control module 7                        |    |   |
| 30 | Body control module 6                        |    |   |
| 31 | Body control module 5                        |    |   |
| 32 | Body control module 4                        |    |   |
| 33 | Body control module 3                        |    |   |
| 34 | Body control module 2 (Non CVT Stop & Start) |    |   |
| 35 | Body control module 1 (Non CVT Stop & Start) |    |   |

## Vehicle Tools

### Tools

#### Vehicles with tyre repair kit

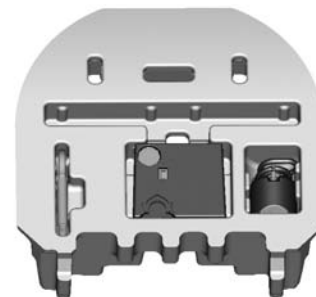

The vehicle tools are in the compartment under the floor cover in the load compartment, together with the tyre repair kit.

## 178 Vehicle Care

### Vehicles with spare wheel

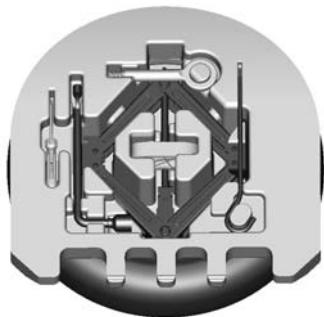

The jack and the vehicle tools are in the load compartment.

See *Tyre Changing* ⇨ 188.

See *Compact Spare Tyre* ⇨ 191.

### Wheels and Tyres

#### Tyre condition, wheel condition

Drive over edges slowly and at right angles if possible. Driving over sharp edges can cause tyre and wheel damage. Do not trap tyres on the kerb when parking.

Regularly check the wheels for damage. Seek the assistance of a workshop in the event of damage or unusual wear.

We recommend not swapping the front wheels with the rear wheels and vice versa, as this can affect vehicle stability. Always use less worn tyres on the rear axle.

#### Winter Tyres

Winter tyres improve driving safety at temperatures below 7 °C and should therefore be fitted on all wheels.

In accordance with country-specific regulations, affix the speed sticker in the driver's field of view.

### Tyre Designations

E.g. **195/65 R 15 91 H**

**195** : Tyre width, mm

**65** : Cross-section ratio (tyre height to tyre width), %

**R** : Belt type: Radial

**RF** : Type: RunFlat

**15** : Wheel diameter, inches

**91** : Load index e.g. 91 is equivalent to 615 kg

**H** : Speed code letter

Speed code letter :

**Q** : Up to 100 mph

**S** : Up to 112 mph

**T** : Up to 118 mph

**H** : Up to 130 mph

**V** : Up to 150 mph

**W** : Up to 168 mph

## Directional tyres

Directional tyres must be mounted so that they rotate in the correct direction. The proper rotation direction is indicated by a symbol (e.g. an arrow) on the sidewall.

## Tyre Pressure

Check the pressure of cold tyres at least every 14 days and before any long journey. Do not forget the spare wheel. This also applies to vehicles with tyre pressure monitoring system.

Unscrew the valve cap.



Tyre pressure ⇨ *Tyre Pressure* ⇨ 209.

The tyre pressure information label on the left door frame indicates the original equipment tyres and the correspondent tyre pressures.

Always inflate the spare tyre to the pressure specified for full load.

The ECO tyre pressure serves to achieve the lowest fuel consumption possible.

Incorrect tyre pressures will impair safety, vehicle handling, comfort and fuel economy and will increase tyre wear.

Tyre pressures differ depending on various options. For the correct tyre pressure value, follow the procedure below:

1. Identify the engine identifier code. ⇨ *Engine Data* ⇨ 207.
2. Identify the respective tyre.

The tyre pressure tables show all possible tyre combinations ⇨ *Tyre Pressure* ⇨ 209

For the tyres approved for your vehicle, refer to the EEC Certificate of Conformity provided with your vehicle or other national registration documents.

The driver is responsible for correct adjustment of tyre pressure.

### Warning

If the pressure is too low, this can result in considerable tyre warmup and internal damage, leading to tread separation and even to tyre blow-out at high speeds.

If the tyre pressure must be reduced or increased on a vehicle with tyre pressure monitoring system, switch off ignition.

After adjusting tyre pressure switch on ignition and select the according setting on the page Tyre load in the Driver Information Centre, ⇨ *Driver Information Centre (DIC)* ⇨ 75.

## 180 Vehicle Care

### Tyre Pressure Monitor System

The tyre pressure monitoring system (TPMS) checks the pressure of all four wheels once a minute when vehicle speed exceeds a certain limit.

#### Caution

Tyre pressure monitoring system warns only about low tyre pressure condition and does not replace regular tyre maintenance by the driver.

All wheels must be equipped with pressure sensors and the tyres must have the prescribed pressure.

**Note:** In countries where the tyre pressure monitoring system is legally required, the use of wheels without pressure sensors will invalidate the vehicle type approval.

The current tyre pressures can be shown in the Vehicle Information Menu in the Driver Information Centre (DIC).

The menu can be selected by the buttons on the indicator lever.



Press the **MENU** to select the **Vehicle Information MENU** .

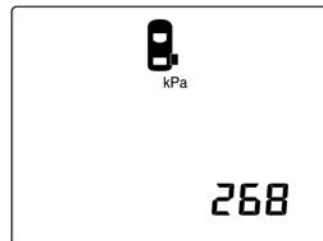

Turn the adjuster wheel to select the tyre pressure monitoring system.

System status and pressure warnings are displayed by a message with the corresponding tyre flashing in the DIC.

The system considers the tyre temperature for the warnings.



A detected low tyre pressure condition is indicated by the control indicator (⚠) ⇨ *Tyre Pressure Monitoring System Light* ⇨ 73.

If (⚠) illuminates, stop as soon as possible and inflate the tyres as recommended ⇨ *Tyre Pressure* ⇨ 209.

If (⚠) flashes for 60-90 seconds and then illuminates continuously, there is a fault in the system. Consult a workshop.

After inflating, driving may be required to update the tyre pressure values in the DIC. During this time (⚠) may illuminate.

If (⚠) illuminates at lower temperatures and extinguishes after some driving, this could be an indicator for getting low pressure. Check tyre pressure.

Vehicle messages ⇨ *Vehicle Messages* ⇨ 80.

If the tyre pressure shall be reduced or increased, switch off ignition.

Only mount wheels with pressure sensors, otherwise the tyre pressure will not be displayed and (⚠) illuminates continuously.

A temporary spare wheel is not equipped with pressure sensors. The tyre pressure monitoring system is not operational for these wheels. Control indicator (⚠) illuminates. For the further three wheels the system remains operational.

The use of commercially available liquid tyre repair kits can impair the function of the system. Factory approved repair kits can be used.

External high-power radio equipment could disrupt the tyre pressure monitoring system.

Each time the tyres are replaced tyre pressure monitoring system sensors must be dismantled and serviced. For the screwed sensor : Replace valve core and sealing ring. For clipped sensor : Replace complete valve stem.

### Vehicle loading status

Adjust tyre pressure to load condition according to tyre information label or tyre pressure chart ⇨ *Tyre Pressure* ⇨ 209, and select the relevant setting in the menu Tyre Load in the Driver Information Centre, Vehicle Information Menu ⇨ *Driver Information Centre (DIC)* ⇨ 75.

This setting is the reference for the tyre pressure warnings.

## 182 Vehicle Care

The menu Tyre Load only appears if the vehicle is in a standstill and the parking brake is applied.



Select :

- **Lo** for comfort pressure up to 3 people
- **Eco** for Eco pressure up to 3 people
- **Hi** for full loading

### TPMS Sensor Matching Process

Each TPMS sensor has a unique identification code. The identification code must be matched to a new

tyre/ wheel position after rotating the tyres or exchanging the complete wheel set and if one or more TPMS sensors were replaced. The TPMS sensor matching process should also be performed after replacing a spare tyre with a road tyre containing the TPMS sensor.

The malfunction light and the warning message or code should go off at the next ignition cycle. The sensors are matched to the tyre/ wheel positions, using a TPMS relearn tool, in the following order : Left side front tyre, right side front tyre, right side rear tyre and left side rear tyre. The turn light at the current active position is illuminated until sensor is matched.

Consult your workshop for service or to purchase a relearn tool. You have two minutes to match the first tyre/ wheel position, and five minutes overall to match all four tyre/wheel positions. If it takes longer, the matching process stops and must be restarted.

The TPMS sensor matching process is outlined below:

1. Apply the parking brake.
2. Turn the ignition on.
3. Move selector lever to neutral.
4. Use **MENU** on the indicator lever to select the **Vehicle Information Menu** in the Driver Information Centre (DIC).
5. Turn the adjuster wheel to scroll to the tyre pressure menu.
6. Press **SET/CLR** to begin the sensor matching process. A message requesting acceptance of the process should display.
7. Press **SET/CLR** again to confirm the selection. The horn sounds twice to signal the receiver is in relearn mode.
8. Start with the left side front tyre.
9. Place the relearn tool against the tyre sidewall, near the valve stem. Then press the

button to activate the TPMS sensor. A horn chirp confirms that the sensor identification code has been matched to this tyre and wheel position.

10. Proceed to the right side front tyre, and repeat the procedure in Step 9.
11. Proceed to the right side rear tyre, and repeat the procedure in Step 9.
12. Proceed to the left side rear tyre, and repeat the procedure in Step 9. The horn sounds twice to indicate the sensor identification code has been matched to the left side rear tyre, and the TPMS sensor matching process is no longer active.
13. Turn off the ignition.
14. Set all four tyres to the recommended air pressure level as indicated on the tyre pressure label.

15. Ensure the tyre loading status is set according selected pressure ⇨ *Driver Information Centre (DIC)* ⇨ 75.

### Temperature dependency

The tyre pressure depends on the temperature of the tyre. During driving, tyre temperature and pressure increase. Tyre pressure values provided on the tyre information label and tyre pressure chart are valid for cold tyres, which means at 20 °C. The pressure increases by nearly 10 kPa for a 10 °C temperature increase. This must be considered when warm tyres are checked.

The tyre pressure value displayed in the DIC shows the real tyre pressure. A cooled down tyre will show a decreased value, which does not indicate an air leak.

### Tread Depth

Check tread depth at regular intervals.

Tyres should be replaced for safety reasons at a tread depth of 2-3 mm (4 mm for winter tyres).

For safety reasons it is recommended that the tread depth of the tyres on one axle should not vary by more than 2 mm.



The legally permissible minimum tread depth (1.6 mm) has been reached when the tread has worn down as far as one of the tread wear indicators (TWI). Their position is indicated by markings on the sidewall.



## 184 Vehicle Care

Tyres age, even if they are not used. We recommend tyre replacement every 6 years.

### Changing tyre and wheel size

If tyres of a different size than those fitted at the factory are used, it may be necessary to reprogramme the speedometer as well as the nominal tyre pressure and to make other vehicle modifications

After converting to a different tyre size, have the label with tyre pressures replaced.

#### Warning

Use of unsuitable tyres or wheels may lead to accidents and will invalidate the vehicle type approval.

### Wheel Covers

Wheel covers and tyres that are factory approved for the respective vehicle and comply with all of the relevant wheel and tyre combination requirements must be used.

If the wheel covers and tyres used are not factory approved, the tyres must not have a rim protection ridge.

Wheel covers must not impair brake cooling.

#### Warning

Use of unsuitable tyres or wheel covers could lead to sudden pressure loss and thereby accidents.

### Tyre Chains



Tyre chains are only permitted on the front wheels.

Always use fine mesh chains that add no more than 10 mm to the tyre tread and the inboard sides (including chain lock).

#### Warning

Damage may lead to tyre blowout.

Tyre chains are only permitted on tyres of size 165/65 R14.

Tyre chains are not permitted on tyres of size 185/55 R15 and 195/45 R16.

The use of tyre chains is not permitted on the temporary spare wheel.

### Tyre Repair Kit

Minor damage to the tyre tread can be repaired with the tyre repair kit.

Do not remove foreign bodies from the tyres.

Tyre damage exceeding 4 mm or that is at tyre's side wall near the rim cannot be repaired with the tyre repair kit.

**Warning**

Do not drive faster than 50 mph.  
Do not use for a lengthy period.  
Steering and handling may be affected.

If you have a flat tyre :

Apply the parking brake.

For manual gearbox, engage first gear or reverse gear.



The tyre repair kit is in the tool box under the floor cover in the load compartment.

1. Open the storage.

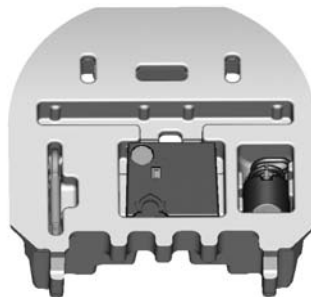

2. Remove the compressor and the sealant bottle.

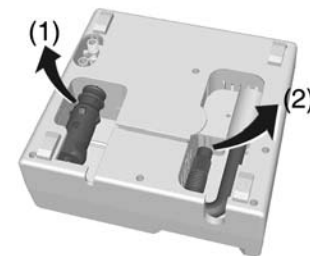

3. Remove the electrical connection cable (1) and air hose (2) from the stowage compartments on the underside of the compressor.

## 186 Vehicle Care



4. The switch on the compressor must be set to .
5. Screw the compressor air hose to the connection on the sealant bottle.
6. Connect the compressor plug to the accessory socket (power socket or cigarette lighter.)  
To avoid discharging the battery, we recommend running the engine.
7. Fit the sealant bottle into the retainer on the compressor.  
Set the compressor near the tyre in such a way that the sealant bottle is upright.

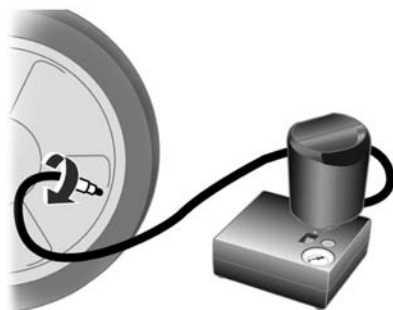

8. Unscrew valve cap from defective tyre.
9. Screw the filler hose to the tyre valve.

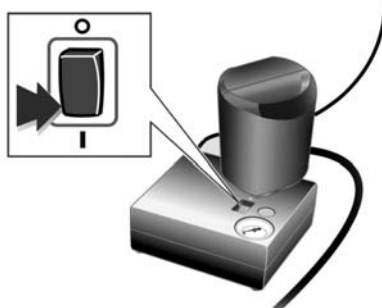

10. Set the rocker switch on the compressor to I. The tyre is filled with sealant.
11. The compressor pressure gauge briefly indicates up to 6 bar whilst the sealant bottle is emptying (approx. 30 seconds). Then the pressure starts to drop.
12. All of the sealant is pumped into the tyre. Then the tyre is inflated.



13. The prescribed tyre pressure (approx. 2.4 bar) should be obtained within 10 minutes. When the correct pressure is obtained, switch off the compressor.

If the prescribed tyre pressure is not obtained within 10 minutes, remove the tyre repair kit. Move the vehicle one tyre rotation.

Reattach the tyre repair kit and continue the filling procedure for 10 minutes. If the prescribed tyre pressure is still not obtained, the tyre is too badly damaged. Seek the assistance of a workshop.

Drain excess tyre pressure with the button over the pressure indicator.

Do not run the compressor longer than 10 minutes.

14. Detach the tyre repair kit. Push catch on bracket to remove sealant bottle from bracket. Screw tyre inflation hose to free connection of sealant bottle. This prevents sealant from escaping.

Stow tyre repair kit in tailgate.

15. Remove any excess sealant using a cloth.
16. Take the label indicating maximum permitted speed (approx. 50 mph) from the sealant bottle and affix in the driver's field of view.

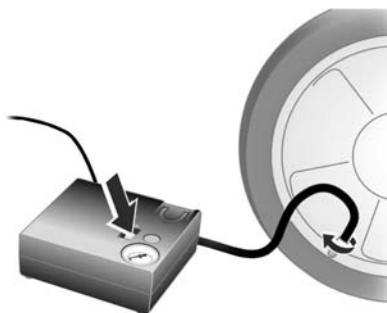

17. Continue driving immediately so that sealant is evenly distributed in the tyre. After driving approx. 6 miles (but no more than 10 minutes), stop and check tyre pressure. Screw compressor air hose directly onto tyre valve and compressor when doing this.

If tyre pressure is more than 1.3 bar, set it to the correct value (approx. 2.4 bar).

Repeat the procedure until there is no more loss of pressure.

If the tyre pressure has fallen below 1.3 bar, the vehicle must not be used. Seek the assistance of a workshop.

18. Stow away tyre repair kit in tailgate.

**Note:** The driving characteristics of the repaired tyre is severely affected, therefore have this tyre replaced.

## 188 Vehicle Care

If unusual noise is heard or the compressor becomes hot, turn compressor off for at least 30 minutes.

Note the expiry date of the kit. After this date its sealing capability is no longer guaranteed. Pay attention to storage information on sealant bottle.

Replace the used sealant bottle. Dispose of the bottle as prescribed by applicable laws.

The compressor and sealant can be used from approx. -30°C ~ 70°C (-22 ~ 158°F).

### Tyre Changing

Some vehicles are equipped with a tyre repair kit instead of a spare wheel.

Make the following preparations and observe the following information :

- Park the vehicle on a level, firm and non-skid surface. The front wheels must be in the straight-ahead position.

- Apply the parking brake.

For manual gearbox, engage first gear or reverse gear.

- Remove the spare wheel.

See "Temporary spare wheel" under *Compact Spare Tyre* ⇨ 191.

- Never change more than one wheel at once.
- Use the jack only to change wheels in case of puncture, not for seasonal winter or summer tyre change. The jack is maintenance-free.
- If the ground on which the vehicle is standing is soft, a solid board (max. 1cm (0.4 inches) thick) should be placed under the jack. Take heavy objects out of the vehicle before jacking up.
- No people or animals may be in the vehicle when it is jacked-up.
- Never crawl under a jacked-up vehicle.
- Do not start the vehicle when it is raised on the jack.

- Clean wheel nuts and thread before mounting the wheel.

Do not grease wheel bolt, wheel nut and wheel nut cone.

### Wheel changing

Make the following preparations and observe the following information:

- Park the vehicle on a level, firm and non-skid surface. The front wheels must be in the straight-ahead position.
- Apply the parking brake and engage first gear, reverse gear or P.
- Never change more than one wheel at once.
- Use the jack only to change wheels in case of puncture, not for seasonal winter or summer tyre change.
- The jack is maintenance-free.
- If the ground on which the vehicle is standing is soft, a solid board (max. 1 cm thick) should be placed under the jack.

- Take heavy objects out of the vehicle before jacking up.
- No people or animals may be in the vehicle when it is jacked-up.
- Never crawl under a jacked-up vehicle.
- Do not start the vehicle when it is raised on the jack.
- Clean wheel nuts and thread with a clean cloth before mounting the wheel.

 **Warning**

Do not grease wheel bolt, wheel nut and wheel nut cone.

1. **Steel wheels:**

Pull off the wheel cover.

**Alloy wheels with bolt caps:**

Disengage wheel bolt caps with a screwdriver and remove. To protect the wheel, place a soft cloth between the screwdriver and the alloy wheel.

**Alloy wheels with centre cap:**

Insert extractor in the open slot of the centre cap and withdraw the cap from the wheel. Vehicle tools ⇨ *Tools* ⇨ 177.

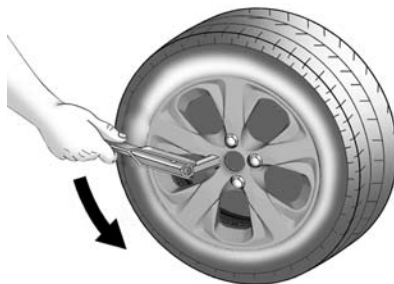

2. Install the wheel wrench ensuring that it locates securely and loosen each wheel bolt by half a turn.

The wheels might be protected by locking wheel bolts. To loosen these specific bolts, first attach the adapter for the locking wheel bolts onto the head of the bolt before installing the wheel wrench. The adapter is located in the glovebox.

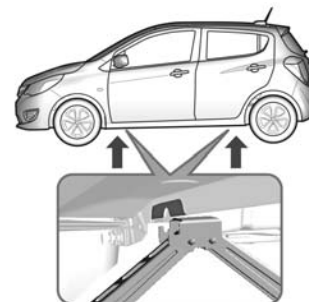

3. Ensure the jack is correctly positioned under the relevant vehicle jacking point.

## 190 Vehicle Care

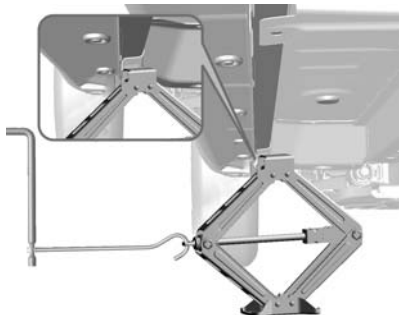

4. Set the jack to the necessary height. Position it directly below the jacking point in a manner that prevents it from slipping.  
Attach jack handle and with the jack correctly aligned rotate jack handle until wheel is clear of the ground.
5. Unscrew the wheel bolts.
6. Change the wheel.
7. Screw on the wheel bolts.
8. Lower vehicle.
9. that it locates securely and tighten each bolt in a crosswise sequence. Tightening torque is 140 Nm.

10. Align the valve hole in the wheel cover of the steel wheel with the tyre valve before installing.

Install wheel bolt caps or centre cap on alloy wheel.

11. Install vehicle jacking point cover.
12. Stow and secure the replaced wheel, the vehicle tools and the adapter for the locking wheel bolts.
13. Check the tyre pressure of the installed tyre and the wheel bolt torque as soon as possible.  
Have the defective tyre renewed or repaired as soon as possible.

### Jacking position for lifting platform

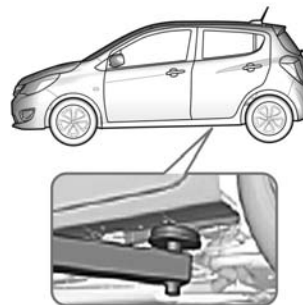

Rear arm position of the lifting platform located centrally under the recess of the sill.

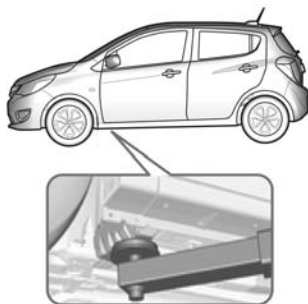

Front arm position of the lifting platform at the underbody.

## Compact Spare Tyre

Some vehicles are equipped with a tyre repair kit instead of a spare wheel.

If mounting a spare wheel, which is different from the other wheels, this wheel might be classified as a temporary spare wheel and the corresponding speed limits apply, even though no label indicates this.

Seek the assistance of a workshop to check the applicable speed limit.

The spare wheel has a steel rim.

### Caution

Use of a spare wheel that is smaller than the other wheels or together with winter tyres could affect drive ability. Have the defective tyre replaced as soon as possible.

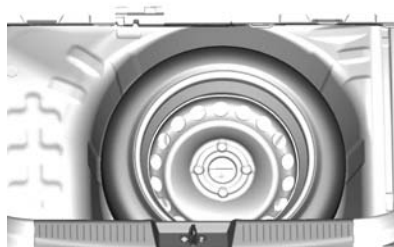

The spare wheel is located in the load compartment beneath the floor covering. It is secured in the recess with a wing bolt.

The spare wheel well is not designed for all permitted tyre sizes. If a wheel wider than the spare must

be stowed in the spare wheel well after changing wheels, the floor cover can be placed on the projecting wheel.

### Temporary spare wheel

Use of the temporary spare wheel could affect drive ability. Have the defective tyre renewed or repaired as soon as possible.

Only mount one temporary spare wheel. Do not drive faster than 50 mph. Take bends slowly. Do not use for a long period of time.

### Storing a replaced wheel in the load compartment using a strap

Use the strap placed in the tool box.

Vehicle tools ⇨ *Tools* ⇨ 177.

1. Remove load compartment cover and lift up load compartment floor. Position the Tool box and the damaged wheel to stand upright into the tool box spare.



## 192 Vehicle Care

2. Pull up the release knob on top of the rear seat backrest forward.

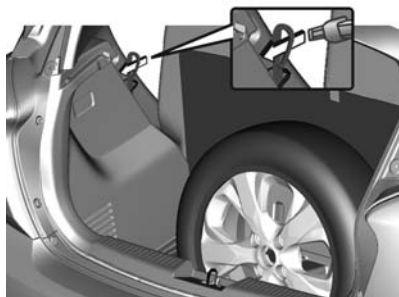

3. Place the loop end of the strap from tool box through the seat back latch.
4. Place the hook end of the strap through the loop and pull it until the strap is fastened securely to the seat back latch.



5. Pull back backrests of the rear seats.
6. Mount the hook to the tailgate latch.
7. Tighten the strap and secure it using the buckle.

## Jump Starting

Do not start with quick charger.

A vehicle with a discharged battery can be started using jump leads and the battery of another vehicle.

### Warning

Be extremely careful when starting with jump leads. Any deviation from the following instructions can lead to injuries or damage caused by battery explosion or damage to the electrical systems of both vehicles.

Avoid contact with eyes, skin, fabrics and painted surfaces. The fluid contains sulphuric acid which can cause injuries and damage in the event of direct contact.

- Never expose the battery to naked flames or sparks.

- A discharged battery can already freeze at temperatures of 0 °C.

Defrost the frozen battery before connecting jump leads.

- Wear eye protection and protective clothing when handling a battery.
- Use a booster battery with the same voltage (12 volts). Its capacity (Ah) must not be much less than that of the discharged battery.
- Use jump leads with insulated terminals and a cross section of at least 16 mm<sup>2</sup> (25 mm<sup>2</sup> for diesel).
- Do not disconnect the discharged battery from the vehicle.
- Switch off all unnecessary electrical consumers.
- Do not lean over the battery during jump starting.
- Do not allow the terminals of one lead to touch those of the other lead.

- The vehicles must not come into contact with each other during the jump starting process.
- Apply the parking brake, manual gearbox in neutral, automatic transmission in P.
- Open the positive terminal protection caps of both vehicle batteries.

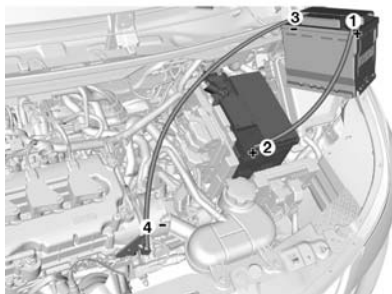

Lead connection order :

1. Connect the red lead to the positive terminal of the booster battery.

2. Connect the other end of the red lead to the positive terminal of the discharged battery.
3. Connect the black lead to the negative terminal of the booster battery.
4. Connect the other end of the black lead to a vehicle grounding point, such as the engine block or an engine mounting bolt. Connect as far away from the discharged battery as possible, however at least 60 cm(24 inches).

Route the leads so that they cannot catch on rotating parts in the engine compartment.

To start the engine :

1. Start the engine of the vehicle providing the jump.
2. After 5 minutes, start the other engine. Start attempts should be made for no longer than 15 seconds at an interval of 1 minute.

## 194 Vehicle Care

3. Allow both engines to idle for approx. 3 minutes with the leads connected.
4. Switch on electrical consumers (e.g. headlights, heated rear window) of the vehicle receiving the jump start.
5. Reverse above sequence exactly when removing leads.

### Towing the Vehicle

If towing service is not available in an emergency, your vehicle may be temporarily towed by a rope secured to the emergency towing eye.



Disengage cap by using the screwdriver and remove the cap.

The towing eye is stowed with the vehicle tools.

See *Tools* ⇨ 177.



Screw in the towing eye as far as it will go until it stops in a horizontal position. (Should be contact with tow nut.)

Attach a tow rope or better still a tow rod to the towing eye.

The towing eye must only be used for towing and not for recovering the vehicle.

Switch on ignition to release steering column lock and to permit operation of brake lights, horn and windscreen wipers.

Transmission in neutral.

### Caution

Drive slowly. Do not drive jerkily. Excessive tractive force can damage the vehicle.

When the engine is not running, considerably more force is needed to brake and steer.

To prevent the entry of exhaust fumes from the towing vehicle, switch on the air recirculation and close the windows.

The vehicle must be towed facing forward, not faster than 55 mph. In all other cases and when the transmission is defective, the front axle must be raised off the ground.

Seek the assistance of a workshop.

After towing, unscrew the towing eye.

Insert cap and close cap.

## Appearance Care

### Exterior Care

#### Locks

The locks are lubricated at the factory using a high quality lock cylinder grease. Use de-icing agent only when absolutely necessary, as this has a degreasing effect and impairs lock function. After using de-icing agent, have the locks re-greased by a workshop.

#### Washing

The paintwork of your vehicle is exposed to environmental influences. Wash and wax your vehicle regularly. When using automatic vehicle washes, select a programme that includes waxing.

Bird droppings, dead insects, resin, pollen and the like should be cleaned off immediately, as they contain aggressive constituents which can cause paint damage.

If using a vehicle wash, comply with the vehicle wash manufacturer's instructions. The windscreen wipers

and rear window wiper must be switched off. Lock the vehicle so that the fuel filler flap cannot be opened. Remove antenna and external accessories such as roof racks etc.

If you wash your vehicle by hand, make sure that the insides of the wheel housings are also thoroughly rinsed out.

Clean edges and folds on opened doors and the bonnet as well as the areas they cover.

### Caution

Always use a cleaning agent with a pH value of 4 to 9.

Do not use cleaning agents on hot surfaces.

Have the door hinges of all doors greased by a workshop.

Do not clean the engine compartment with a steam-jet or high-pressure jet cleaner.

## 196 Vehicle Care

Thoroughly rinse and leather-off the vehicle. Rinse leather frequently. Use separate leathers for painted and glass surfaces : Remnants of wax on the windows will impair vision.

Do not use hard objects to remove spots of tar. Use tar removal spray on painted surfaces.

### Exterior lights

Headlamp and other lamp covers are made of plastic.

Do not use any abrasive or caustic agents, do not use an ice scraper, and do not clean them dry.

### Polishing and waxing

Wax the vehicle regularly (at the latest when water no longer beads). Otherwise, the paintwork will dry out.

Polishing is necessary only if the paint has become dull or if solid deposits have become attached to it.

Paintwork polish with silicone forms a protective film, making waxing unnecessary.

Plastic body parts must not be treated with wax or polishing agents.

### Windows and windscreen wiper blades

Use a soft lint-free cloth or chamois leather together with window cleaner and insect remover.

When cleaning the rear window, make sure the heating element inside is not damaged.

For mechanical removal of ice, use a sharp-edged ice scraper. Press the scraper firmly against the glass so that no dirt can get under it and scratch the glass.

Clean smearing wiper blades with a soft cloth and window cleaner.

### Sunroof

Never clean with solvents or abrasive agents, fuels, aggressive media (e.g. paint cleaner, acetone containing solutions etc.), acidic or highly alkaline media or abrasive pads. Do not apply wax or polishing agents to the sunroof.

### Wheels and tyres

Do not use high-pressure jet cleaners.

Clean rims with a pH-neutral wheel cleaner.

Rims are painted and can be treated with the same agents as the body.

### Paintwork damage

Rectify minor paintwork damage with a touch-up pen before rust forms. Have more extensive damage or rust areas repaired by a workshop.

### Underbody

Some areas of the vehicle underbody have a PVC undercoating while other critical areas have a durable protective wax coating.

After the underbody is washed, check the underbody and have it waxed if necessary.

Bitumen/rubber materials could damage the PVC coating. Have underbody work carried out by a workshop.

Before and after winter, wash the underbody and have the protective wax coating checked.

## Interior Care

### Interior and upholstery

Only clean the vehicle interior, including the instrument panel fascia and panelling, with a dry cloth or interior cleaner.

Clean the leather upholstery with clear water and a soft cloth. In case of heavy soiling, use leather care.

The instrument cluster and the displays should only be cleaned using a soft damp cloth. If necessary use a weak soap solution.

Clean fabric upholstery with a vacuum cleaner and brush. Remove stains with an upholstery cleaner.

Clothing fabrics may not be colour-fast. This could cause visible discolourations, especially on light coloured upholstery.

Removable stains and discolourations should be cleaned as soon as possible. Clean seat belts with lukewarm water or interior cleaner.

#### Caution

Close Velcro fasteners as open Velcro fasteners on clothing could damage seat upholstery.

The same applies to clothing with sharp-edged objects, like Zips or belts or studded jeans.

### Plastic and rubber parts

Plastic and rubber parts can be cleaned with the same cleaner as used to clean the body. Use interior cleaner if necessary. Do not use any other agent. Avoid solvents and petrol in particular. Do not use high-pressure jet cleaners.

## 198 Service and Maintenance

### Service and Maintenance

#### General Information

Service Information ..... 198

#### Recommended Fluids, Lubricants, and Parts

Recommended Fluids and Lubricants ..... 200

### General Information

#### Service Information

In order to ensure economical and safe vehicle operation and to maintain the value of your vehicle, it is of vital importance that all maintenance work is carried out at the proper intervals as specified.

The detailed, up-to-date service schedule for your vehicle is available at the workshop.

Service display ⇨ *Service Display* ⇨ 68.

#### European service intervals

Maintenance of your vehicle is required every 16,000 miles or after 1 year, whichever occurs first, unless otherwise indicated in the service display.

A shorter service interval can be valid for severe driving behaviour, e.g. for taxis and police vehicles.

The European service intervals are valid for the following countries:

Andorra, Austria, Belgium, Bosnia-Herzegovina, Bulgaria, Croatia, Cyprus, Czech Republic, Denmark, Estonia, Finland, France, Germany, Greece, Greenland, Hungary, Iceland, Ireland, Italy, Latvia, Liechtenstein, Lithuania, Luxembourg, Macedonia, Malta, Monaco, Montenegro, Netherlands, Norway, Poland, Portugal, Romania, San Marino, Serbia, Slovakia, Slovenia, Spain, Sweden, Switzerland, United Kingdom.

Service display ⇨ *Service Display* ⇨ 68.

### **International service intervals**

Maintenance of your vehicle is required every 10,000 miles or after 1 year, whichever occurs first, unless otherwise indicated in the service display.

The international service intervals are valid for the countries which are not listed in the European service intervals.

Service display ⇨ *Service Display* ⇨ 68.

### **Confirmations**

Confirmation of service is recorded in the Service and Warranty Booklet. The date and mileage is completed with the stamp and signature of the servicing workshop.

Make sure that the Service and Warranty Booklet is completed correctly as continuous proof of service is essential if any warranty or goodwill claims are to be met, and is also a benefit when selling the vehicle.

### **Service interval with remaining engine oil life duration**

The service interval is based on several parameters depending on usage.

The service display lets you know when to change the engine oil.

Service display ⇨ *Service Display* ⇨ 68.



## 200 Service and Maintenance

### Recommended Fluids, Lubricants, and Parts

#### Recommended Fluids and Lubricants

Only use products that meet the recommended specifications. Damage resulting from the use of products not compliant with these specifications will not be covered by the warranty.

#### Warning

Operating materials are hazardous and could be poisonous. Handle with care. Pay attention to information given on the containers.

#### Engine oil

Engine oil is identified by its quality and its viscosity. Quality is more important than viscosity when selecting which engine oil to use. The oil quality ensures e.g. engine cleanliness, wear protection and oil ageing control, whereas viscosity grade gives information on the oil's thickness over a temperature range.

Dexos is the newest engine oil quality that provides optimum protection for petrol and diesel engines. If it is unavailable, engine oils of other listed qualities have to be used. Recommendations for petrol engines are also valid for Compressed Natural Gas (CNG), Liquefied Petroleum Gas (LPG) and Ethanol (E85) fuelled engines.

Select the appropriate engine oil based on its quality and on the minimum ambient temperature ⇨ *Recommended Fluids and Lubricants* ⇨ 200.

#### Topping up engine oil

Engine oils of different manufacturers and brands can be mixed as long as they comply with the required engine oil quality and viscosity.

Use of engine oil with only ACEA A1/B1 or only A5/B5 quality is prohibited, since it can cause longterm engine damage under certain operating conditions.

Select the appropriate engine oil based on its quality and on the minimum ambient temperature ⇨ *Recommended Fluids and Lubricants* ⇨ 200.

#### Additional engine oil additives

The use of additional engine oil additives could cause damage and invalidate the warranty.

### Engine oil viscosity grades

The SAE viscosity grade gives information of the thickness of the oil.

Multi-grade oil is indicated by two figures, e.g. SAE 5W-30. The first figure, followed by a W, indicates the low temperature viscosity and the second figure the high temperature viscosity.

Select the appropriate viscosity grade depending on the minimum ambient temperature ⇨

*Recommended Fluids and Lubricants* ⇨ 200.

All of the recommended viscosity grades are suitable for high ambient temperatures.

### Coolant and antifreeze

Use only organic acid type-long life coolant (LLC) antifreeze approved for the vehicle. Consult a workshop.

The system is factory filled with coolant designed for excellent corrosion protection and frost protection down to approx. -36 °C. In northern countries with very low temperatures the factory filled coolant provides frost protection down to approx. -50 °C. This concentration should be maintained all year round. The use of additional coolant additives intended to give additional corrosion protection or seal against minor leaks can cause function problems. Liability for consequences resulting from the use of additional coolant additives will be rejected.

### Brake and clutch fluid

Over time, brake fluid absorbs moisture which will reduce braking effectiveness. The brake fluid should therefore be replaced at the specified interval.

## 202 Service and Maintenance

### European service schedule

#### Required engine oil quality

	All European countries with European service interval
Engine oil quality	Petrol engines (including CNG, LPG, E85)
dexos 1	
dexos 2	✓

In case dexos quality is unavailable you may use max. 1 litre engine oil quality ACEA C3 for topping up once between each oil change.

#### Engine oil viscosity grades

	All European countries with European service interval
Ambient temperature	Petrol
down to -25 °C	SAE 5W-30 or SAE 5W-40
below -25 °C	SAE 0W-30 or SAE 0W-40

**International service schedule**

**Required engine oil quality**

	<b>All countries with international service interval</b>
Engine oil quality	Petrol engines (including CNG, LPG, E85)
dexos 1	✓
dexos 2	✓

In case dexos quality is unavailable you may use the oil qualities listed below :

	<b>All countries with international service interval</b>
Engine oil quality	Petrol engines (including CNG, LPG, E85)
GM-LL-A-025	✓
GM-LL-B-025	-
ACEA A3/B3	✓
ACEA A3/B4	✓
ACEA C3	✓
API SM	✓
API SN resource conserving	✓

## 204 Service and Maintenance

---

### Engine oil viscosity grades

	<b>All countries with international service interval</b>
Ambient temperature	Petrol
down to -25 °C	SAE 5W-30 or SAE 5W-40
below -25 °C	SAE 0W-30 or SAE 0W-40
down to -20 °C	SAE 10W-30 1) or SAE 10W-40 1)
1) Permitted, but use of SAE 5W-30 or SAE 5W-40 with dexos quality is recommended.	

## Technical Data

### Vehicle Identification

Vehicle Identification Number (VIN) .....	205
Engine Identification .....	205
Identification Plate .....	206

### Vehicle Data

Engine Data .....	207
Performance .....	207
Vehicle Weight .....	208
Vehicle Dimensions .....	208
Capacities and Specifications .....	209
Tyre Pressure .....	209

## Vehicle Identification

### Vehicle Identification Number (VIN)

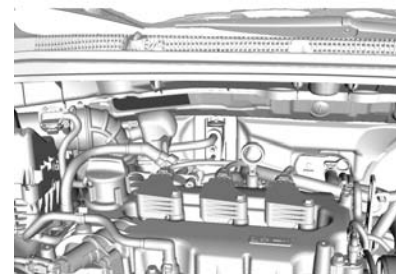
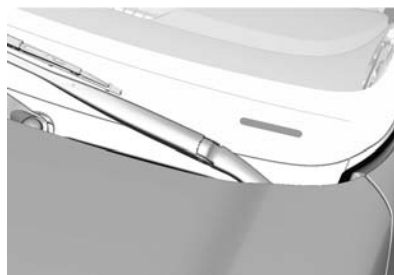

The Vehicle Identification Number is located in the engine compartment. The Vehicle Identification Number may be embossed on the instrument panel, visible through the windscreen.

### Engine Identification

The technical data tables show the engine identifier code. Engine data  
⇒ *Engine Data* ⇒ 207.

To identify the respective engine, refer to the engine power in the EEC Certificate of Conformity provided with your vehicle or other national registration documents.

## 206 Technical Data

### Identification Plate

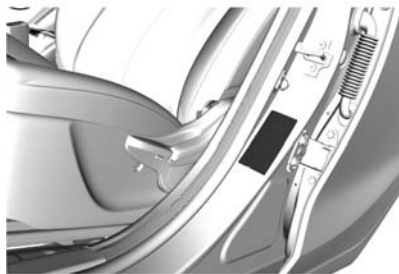

The identification plate is on the left side door frame.

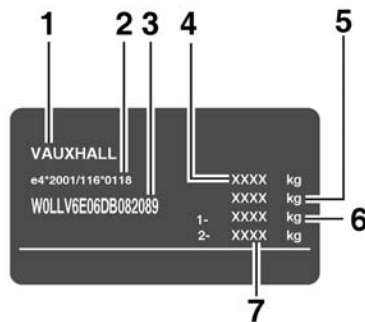

Information on identification label:

- 1 = Manufacturer
- 2 = Type approval number
- 3 = Vehicle Identification Number
- 4 = Permissible gross vehicle weight rating in kg
- 5 = Permissible gross train weight in kg
- 6 = Maximum permissible front axle load in kg
- 7 = Maximum permissible rear axle load in kg

The combined total of front and rear axle loads must not exceed the permissible gross vehicle weight. For example, if the front axle is bearing its maximum permissible load, the rear axle can only bear a load that is equal to the gross vehicle weight minus the front axle load.

The technical data is determined in accordance with European Community standards. We reserve the right to make modifications.

Specifications in the vehicle documents always have priority over those given in this manual.

## Vehicle Data

### Engine Data

<b>Sales designation</b>	<b>1.0</b>
<b>Engine identifier code</b>	<b>L5Q</b>
Number of cylinders	3
Piston displacements [cm <sup>3</sup> ]	999
Engine Power [kW] at rpm	55
Torque [Nm] at rpm	95
Octane rating RON	
recommended	95
possible	98
possible	91
Fuel type	Petrol

### Performance

<b>Engine</b>	<b>1.0</b>
Top speed [km/h] ([mph])	
Manual gearbox	106 mph
Automatic transmission	-



## 208 Technical Data

---

### Vehicle Weight

#### Kerb weight, Basic model without any optional equipment

	Engine	4 seater	5 seater
Without/without air conditioning [kg]	L5Q	938/947	939/945

Optional equipment and accessories increase the Kerb weight.

Loading information.

### Vehicle Dimensions

Length [mm]	3675
Width without exterior mirrors [mm]	1595
Width with two exterior mirrors [mm]	1876
Height (without aerial) [mm] w/o roof rack	1485
Length of load compartment floor [mm]	486
Length of load compartment with folded rear seats [mm]	1109
Load compartment width [mm]	978
Load compartment height [mm]	522
Height of load compartment opening [mm]	608
Wheelbase [mm]	2385
Turning circle diameter [m]	9.6(14"), 10.4(15")

## Capacities and Specifications

<b>Engine oil</b>	<b>1.0</b>
including Filter [l]	4.5 L
between MIN and MAX [l]	1

<b>Fuel tank</b>	
petrol, nominal capacity [l]	32

## Tyre Pressure

Type	Front[kPa/bar] ([psi])			Rear[kPa]		
	Comfort	ECO	Full load	Comfort	ECO	Full load
165/65R14	220/2.2 (32)	270/2.7 (39)	260/2.6 (38)	210/2.1 (30)	250/2.5 (36)	300/3.0 (43)
185/55R15	220/2.2 (32)	270/2.7 (39)	260/2.6 (38)	210/2.1 (30)	250/2.5 (36)	300/3.0 (43)
195/45R16	220/2.2 (32)	270/2.7 (39)	260/2.6 (38)	210/2.1 (30)	250/2.5 (36)	300/3.0 (43)
T105/70D14 (Spare)	420/4.2 (60)					

## 210 Customer Information

### Customer Information

#### Customer Information

Declaration of Conformity ..... 210

#### Vehicle Data Recording and Privacy

Event Data Recorders ..... 211

Radio Frequency

Identification (RFID) ..... 212

### Customer Information

#### Declaration of Conformity

##### Transmission systems

This vehicle has systems that transmit and/or receive radio waves subject to Directive 1999/5/EC. These systems are in compliance with the essential requirements and other relevant provisions of Directive 1999/5/EC. Copies of the original Declarations of Conformity can be obtained on our website.

##### Jack

Translation of the original declaration of conformity

Declaration of conformity according to EC Directive 2006/42/EC

We declare that the product:

Product designation: Jack

Type/GM part number: 13584087

is in compliance with the provisions of Directive 2006/42/EC.

Applied technical standards:

GMN9737: Jacking

GMW14337: Standard Equipment Jack – Hardware Tests

GMN5127: Vehicle Integrity – Hoisting and Service Station Jacking

GMW15005: Standard Equipment Jack and Spare Tyre, Vehicle Test

ISO TS 16949: Quality management systems

The signatory is authorised to compile the technical documentation.

Rüsselsheim, 31st January 2014

signed by

Hans-Peter Metzger

Engineering Group Manager  
Chassis & Structure

Adam Opel AG

D-65423 Rüsselsheim

## Vehicle Data Recording and Privacy

### Event Data Recorders

#### Data storage modules in the vehicle

A large number of electronic components of your vehicle contain data storage modules temporarily or permanently storing technical data about the condition of the vehicle, events and errors. In general, this technical information documents the condition of parts, modules, systems or the environment:

- Operating conditions of system components (e.g. filling levels)
- Status messages of the vehicle and its single components (e.g. number of wheel revolutions / rotational speed, deceleration, lateral acceleration)

- Dysfunctions and defects in important system components
- Vehicle reactions in particular driving situations (e.g. inflation of an airbag, activation of the stability regulation system)
- Environmental conditions (e.g. temperature)

This data is exclusively technical and helps identify and correct errors as well as optimise vehicle functions.

Motion profiles indicating travelled routes cannot be created with these data.

If services are used (e.g. repair works, service processes, warranty cases, quality assurance), employees of the service network (manufacturer included) are able to read out this technical information from the event and error data storage modules applying special diagnostic devices. If required, you will receive further information at these workshops. After an error has

been corrected, the data is deleted from the error storage module or constantly overwritten.

When using the vehicle, situations may occur in which these technical data related to other information (accident report, damages on the vehicle, witness statements etc.) may be associated with a specific person - possibly, with the assistance of an expert.

Additional functions contractually agreed upon with the client (e.g. vehicle location in emergency cases) allow the transmission of particular vehicle data from the vehicle.

## 212 Customer Information

---

### **Radio Frequency Identification (RFID)**

RFID technology is used in some vehicles for functions such as tyre deflation detection and ignition system security. It is also used in connection with conveniences such as radio remote controls for door locking/unlocking and starting, and in-vehicle transmitters for garage door openers. RFID technology in Opel vehicles does not use or record personal information or link with any other Opel system containing personal information.

## Index

### A

Accessories and Modifications .....	160
Accessory Power .....	141
Adjustable Air Vents .....	135
Adjustments	
Seat, Initial Drive .....	33
Air Conditioning .....	130
Air Conditioning Regular	
Operation .....	137
Air Filter, Passenger	
Compartment .....	136
Air Intake .....	136
Airbags	
Curtain .....	42
Front .....	41
Light On-Off .....	70
On-Off Light .....	70
On-Off Switch .....	43
Safety Belt Tensioner Light .....	70
Side .....	42
System Check .....	38
Alarm System	
Anti-theft .....	24
AM-FM Radio .....	102
Anti-theft	
Alarm System .....	24
Antilock Brake System (ABS) ...	146

Antilock Brake System (ABS) (cont'd)	
Warning Light .....	71
Appearance Care	
Exterior .....	195
Interior .....	197
Audio System	
Theft-Deterrent Feature .....	92
Auto Stop Mode .....	74
Automatic	
Engine Start/Stop Feature ....	141
Auxiliary	
Devices .....	108
<b>B</b>	
Battery .....	164
Jump Starting .....	192
Power Protection .....	91
Blade Replacement, Wiper ....	166
Bluetooth	
Overview .....	116
Bonnet .....	161
Bonnet Ajar Light .....	74
Brakes .....	145, 164
Antilock .....	146
Assist .....	147
Brake and Clutch System	
Warning Light .....	71
Fluid .....	164

## 214 Index

Brakes (cont'd)		Central Locking System . . . . .	21	Compartments	
Parking . . . . .	146	Centre Console Lighting . . . . .	90	Storage . . . . .	52
Bulb Replacement		Centre High-Mounted Brake		Conformity	
Centre High-Mounted		lamp (CHMBL) . . . . .	171	Declaration of . . . . .	210
Brake lamp (CHMBL) . . . . .	171	Chains, Tyre . . . . .	184	Control Indicators . . . . .	66
Fog Lamps . . . . .	169	Charging System Light . . . . .	70	Control of a Vehicle . . . . .	138
Front Indicator Lamps . . . . .	169	Check		Convenience Net . . . . .	56
Headlamps . . . . .	167	Engine Light . . . . .	70	Convex Mirrors . . . . .	26
Headlamps and Parking		Child Restraint Installation		Coolant	
Lamps . . . . .	167	Locations . . . . .	46	Engine . . . . .	163
Instrument Panel		Child Restraint Systems		Engine Temperature Gauge . . . . .	68
Illumination . . . . .	172	Top Tether . . . . .	51	Engine Temperature	
Interior Lamps . . . . .	172	Child Restraints		Warning Light . . . . .	73
Number Plate Lamps . . . . .	172	Installation Locations . . . . .	46	Cornering Lights . . . . .	87
Position Lamps . . . . .	88	ISOFIX . . . . .	49	Covers . . . . .	88
Side Indicator Lamps . . . . .	171	Systems . . . . .	44	Misted Lamps . . . . .	88
Taillights . . . . .	169	Cleaning		Rear Compartment/Storage	
Buzzers, Warning . . . . .	81	Exterior Care . . . . .	195	Panel . . . . .	56
<b>C</b>		Interior Care . . . . .	197	Wheel . . . . .	184
Capacities and		Climate Control System		Cruise Control . . . . .	152
Specifications . . . . .	209	Electronic . . . . .	132	Light . . . . .	74
Car Pass . . . . .	19	Climate Control Systems		Cupholders . . . . .	53
Carbon Monoxide		Heating and Ventilation . . . . .	129	Curtain Airbag System . . . . .	42
Engine Exhaust . . . . .	144	Clock . . . . .	63		
Fuel Consumption CO2		Compact Spare Tyre . . . . .	191		
Emissions . . . . .	158	Compartment . . . . .	53		
Catalytic Converter . . . . .	144	Load . . . . .	53		
Caution, Danger, and Warning . . . . .	4				

**D**

Danger, Warning, and Caution . . . . 4  
Data Recorders, Event . . . . . 211  
Daytime Running  
Lamps (DRL) . . . . . 86  
Declaration of Conformity . . . . . 210  
Devices  
Auxiliary . . . . . 108  
Dimensions  
Vehicle . . . . . 208  
Displays  
Service . . . . . 68  
Door  
Ajaz Light . . . . . 74  
Central Locking System . . . . . 21  
Driver Assistance Systems . . . . . 152  
Driver Information  
Centre (DIC) . . . . . 75

**E**

Electrical System  
Engine Compartment Fuse  
Block . . . . . 174  
Fuses . . . . . 173

Electrical System (cont'd)  
Instrument Panel Fuse  
Block . . . . . 176  
Electronic Climate Control  
System . . . . . 132  
Electronic Stability Control . . . . . 148  
Electronic Stability Control  
(ESC) Off Light . . . . . 72  
Electronic Stability Control  
Indicator Light . . . . . 72  
Emissions - CO2  
Fuel Consumption . . . . . 158  
End-of-Life Vehicle Recovery . . . 161  
Engine  
Automatic Start/Stop  
Feature . . . . . 141  
Check and Service Engine  
Soon Light . . . . . 70  
Coolant . . . . . 163  
Coolant Temperature Gauge . . . 68  
Coolant Temperature  
Warning Light . . . . . 73  
Exhaust . . . . . 144  
Pressure Light . . . . . 73  
Reduced Power Light . . . . . 74  
Starting . . . . . 15, 140  
Engine Data . . . . . 207  
Engine Identification . . . . . 205

Entry Lighting . . . . . 90  
Event Data Recorders . . . . . 211  
Exit Lighting . . . . . 90  
Exterior Lamp Controls . . . . . 85

**F**

First Aid Kit . . . . . 57  
Fixed Air Vents . . . . . 136  
Flat Tyre  
Changing . . . . . 188  
Fluid  
Brakes . . . . . 164  
Washer . . . . . 164  
Fog Lamp Light, Rear . . . . . 74  
Fog Lamps  
Bulb Replacement . . . . . 169  
Front . . . . . 87  
Rear . . . . . 87  
Folding Mirrors . . . . . 26  
Front Airbag System . . . . . 41  
Front Fog Lamp  
Light . . . . . 74  
Front Indicator Lamps . . . . . 169  
Front Seat Position Seats  
Adjustment . . . . . 33  
Front Seats  
Adjustment . . . . . 33  
Heated . . . . . 35  
Fuel . . . . . 156



## 216 Index

Fuel (cont'd)			
Consumption - CO2 -			
Emissions .....	158		
Filling the Tank .....	156		
Gauge .....	65		
Low Fuel Warning Light .....	74		
Fuses .....	173		
Engine Compartment Fuse			
Block .....	174		
Instrument Panel Fuse			
Block .....	176		
<b>G</b>			
Gauges			
Engine Coolant Temperature ...	68		
Fuel .....	65		
Indicator .....	69		
Mileometer .....	64		
Rev Counter .....	65		
Service Display .....	68		
Speedometer .....	64		
Trip Odometer .....	64		
Gear Shifting Light .....	71		
Glove Box .....	52		
<b>H</b>			
Hazard Lights .....	86		
Head Restraints .....	31		
Headlamp Range Adjustment ...	86		
Headlamps			
Bulb Replacement .....	167		
Daytime Running			
Lamps (DRL) .....	86		
Main-Beam On Light .....	74		
Main/Dipped Beam Changer ...	85		
Parking Lamps .....	167		
Position Lamps .....	88		
Range Adjustment .....	86		
Heated			
Rear Window .....	29		
Steering Wheel .....	60		
Heated Front Seats .....	35		
Heated Mirrors .....	26		
Heating .....	129		
Heating and Ventilation			
System .....	129		
Hill Start Assist (HSA) .....	147		
Horn .....	12, 61		
<b>I</b>			
Identification Plate .....	206		
Ignition Positions .....	139		
Immobiliser .....	25		
Light .....	74		
Indicator .....	69		
Indicators			
Control .....	66		
Information			
Service .....	198		
Information on Loading the			
Vehicle .....	57		
Instrument Panel			
Overview .....	9		
Storage Area .....	52		
Instrument Panel Illumination ...	172		
Interior Lamps .....	89		
Introduction .....	2, 92		
ISOFIX Child Restraint			
Systems .....	49		
<b>J</b>			
Jump Starting .....	192		
<b>K</b>			
Keys .....	18		

<b>L</b>			
Lamps			
Cornering	87		
Daytime Running (DRL)	86		
Exterior Controls	85		
Front Fog	87		
Front Indicator	169		
Headlamps and Parking			
Lamps	167		
Interior	89, 172		
Malfunction Indicator	70		
Misted Covers	88		
Number Plate	172		
Rear Fog	87		
Reversing	88		
Side Indicator	171		
Taillights	169		
Lane Departure			
Warning (LDW)	154		
Lane Departure Warning Light	72		
Light			
Electronic Stability Control			
(ESC), Off	72		
Gear Shifting	71		
Traction Control			
System (TCS)	72		
Variable Effort Steering	72		
Light, Auto Stop Mode	74		
Lighting			
Centre Console	90		
Entry	90		
Exit	90		
Illumination Control	88		
Lights	72		
Airbag and Safety Belt			
Tensioner	70		
Airbag On-Off	70		
Antilock Brake System			
(ABS) Warning	71		
Bonnet Ajar	74		
Brake and Clutch System	71		
Charging System	70		
Cruise Control	74		
Door Ajar	74		
Engine Coolant Temperature			
Warning	73		
Engine Oil Pressure	73		
Fog Lamp, Rear	74		
Front Fog Lamp	74		
Immobiliser	74		
Lane Departure Warning	72		
Low Fuel Warning	74		
Main-Beam On	74		
Main/Dipped Beam Changer	85		
Reduced Engine Power	74		
Seat Belt Reminders	69		
Lights (cont'd)			
Service Vehicle Soon	71		
Tail lamp Indicator	74		
Tyre Pressure Monitoring			
System	73		
Ultrasonic Parking Sensor	72		
Lights, Hazard	86		
Load Compartment	53		
LoadCompartment	23		
Loading the Vehicle	57		
Locks			
Central Locking System	21		
Safety	23		
Low Fuel Warning Light	74		
<b>M</b>			
Main-Beam On Light	74		
Maintenance			
Air Conditioning Regular			
Operation	137		
Maintenance Schedule			
Recommended Fluids and			
Lubricants	200		
Malfunction Indicator Lamp	70		
Manual Gearbox	145		
Manual Windows	27		
Memorised Settings	20		
Messages			
Vehicle	80		

## 218 Index

Mileometer .....	64
Trip .....	64
Mirrors	
Convex .....	26
Folding .....	26
Heated .....	26
Manual Rearview .....	27
Power .....	26
Misted Lamp Covers .....	88
Monitor System, Tyre	
Pressure .....	180
<b>N</b>	
Net, Convenience .....	56
New Vehicle Run-In .....	139
<b>O</b>	
Oil	
Engine .....	162
Pressure Light .....	73
Operation, Infotainment	
System .....	99
Other Service Items	
Air Conditioning System .....	130
Outlets	
Power .....	63
Outside Temperature .....	63
Overview, Infotainment	
System .....	93

<b>P</b>	
Parking .....	143
Brake .....	146
Ultrasonic Sensor Light .....	72
Parking Assist .....	150
Pass, Car .....	19
Passenger Compartment Air	
Filter .....	136
Performance .....	207
Personalisation	
Vehicle .....	82
Phone	
Bluetooth .....	116
Power	
Mirrors .....	26
Outlets .....	63
Protection, Battery .....	91
Reduced Engine Light .....	74
Retained Accessory (RAP) ...	141
Windows .....	27
Pressure	
Tyre .....	209
Privacy	
Radio Frequency	
Identification (RFID) .....	212

<b>R</b>	
Radio	
Personalisation .....	115
Radio Data System (RDS) .....	106
Radio Frequency	
Identification (RFID) .....	212
Radio Remote Control .....	19
Radios	
AM-FM Radio .....	102
Rear Compartment/Storage	
Panel Cover .....	56
Rear Fog Lamp Light .....	74
Rear Fog Lamps .....	87
Rear Window Washer/Wiper .....	62
Rear Windows	
Heated .....	29
Rearview Mirrors .....	27
Recommended Fluids and	
Lubricants .....	200
Reduced Engine Power Light .....	74
Remote Control	
Radio .....	19
Repair Kit	
Tyre .....	184
Retained Accessory	
Power (RAP) .....	141
Rev Counter .....	65
Reversing Lamps .....	88

Ride Control Systems .....	148	Settings		Storage Areas (cont'd)	
Electronic Stability (ESC) .....	148	Memorised .....	20	Rear Compartment/Storage	
Roof		Side Airbag System .....	42	Panel Cover .....	56
Sunroof .....	29	Side Indicator Lamps .....	171	Storage Compartments .....	52
Running-In, New Vehicle .....	139	Signals, Turn and		Sun Visors .....	29
<b>S</b>		Lane-Change .....	86	Sunroof .....	29
Safety Belts .....	35	Spare Tyre		Switches	
Child Restraints .....	46	Compact .....	191	Airbag On-Off .....	43
Three-Point .....	36	Specifications and		Symbols .....	4
Safety Locks .....	23	Capacities .....	209	Systems	
Seat Belts		Speed Limiter .....	153	Driver Assistance .....	152
Reminders .....	69	Speedometer .....	64	<b>T</b>	
Seats		Start Assist, Hills .....	147	Tail lamp Indicator Light .....	74
Adjustment, Front .....	33	Starting the Engine .....	15, 140	Taillights .....	169
Head Restraints .....	31	Steering .....	138	Technical Data	
Heated Front .....	35	Heated Wheel .....	60	Tyre Pressure .....	209
Position, Front .....	33	Wheel Adjustment .....	60	Temperature	
Service .....	137	Wheel Controls .....	60	Outside .....	63
Accessories and		Storage		Theft-Deterrent Systems	
Modifications .....	160	Load Compartment .....	23, 53	Immobiliser .....	25
Doing Your Own Work .....	161	Vehicle .....	160	Thermometer	
Engine Soon Light .....	70	Storage Areas		Outside Temperature .....	63
Vehicle Soon Light .....	71	Convenience Net .....	56	Three-Point Safety Belt .....	36
Service and Maintenance		Glove Box .....	52	Time .....	63
Service Information .....	198	Information on Loading the		Tools .....	177
Service Display .....	68	Vehicle .....	57	Top Tether Child Restraint	
Service Information .....	198	Instrument Panel .....	52	Systems .....	51

## 220 Index

Towing	
Vehicle .....	194
Traction	
Control System (TCS) .....	147
Traction Control System	
(TCS) Off Light .....	72
Tread Depth .....	183
Triangle, Warning .....	56
Trip Odometer .....	64
Turn and Lane-Change	
Signals .....	86
Tyre Pressure .....	209
Tyre Pressure Monitoring	
System Light .....	73
Tyre Repair Kit .....	184
Tyres	
Chains .....	184
Changing .....	188
Compact Spare .....	191
Designations .....	178
Pressure Monitor System .....	180
Winter .....	178
Tyres and Wheels .....	178

<b>U</b>	
Ultrasonic Parking Sensor	
Light .....	72
Using This Manual .....	3
<b>V</b>	
Variable Effort Steering Light .....	72
Vehicle	
Control .....	138
Identification Number (VIN) .....	205
Messages .....	80
Personalisation .....	82
Service Soon Light .....	71
Towing .....	194
Vehicle Care	
Tyre Pressure .....	179
Vehicle Dimensions .....	208
Vehicle Identification	
Plate .....	206
Vehicle Recovery	
End-of-Life .....	161
Vehicle Storage .....	160
Vehicle Weight .....	208
Ventilation	
Adjustable Air .....	135
Fixed Air Vents .....	136
Visors .....	29

<b>W</b>	
Warning	
Caution and Danger .....	4
Lane Departure (LDW) .....	154
Warning Buzzers .....	81
Warning Triangle .....	56
Warnings	
Hazard Lights .....	86
Washer Fluid .....	164
Weights	
Vehicle .....	208
Wheel Covers .....	184
Wheels and Tyres .....	178
Windows	
Heated, Rear .....	29
Manual .....	27
Power .....	27
Windscreen	
Wiper/Washer .....	61
Winter Tyres .....	178
Wiper Blade Replacement .....	166
Wipers	
Rear Washer .....	62

Copyright by General Motors UK Ltd.

The information contained in this publication is effective as of the date indicated below. General Motors UK Ltd. reserves the right to make changes to the technical specifications, features and design of the vehicles relative to the information contained in this publication, as well as changes to the publication itself.

Edition: 05/2015, General Motors UK Ltd.

Printed on chlorine-free bleached paper.

KTA-2779/1-VX-en

05/2015

