

# COMBO

Owner's Manual



VAUXHALL



---

# Contents

Introduction .....	2
In brief .....	6
Keys, doors and windows .....	20
Seats, restraints .....	44
Storage .....	69
Instruments and controls .....	88
Lighting .....	121
Climate control .....	130
Driving and operating .....	142
Vehicle care .....	211
Service and maintenance .....	251
Technical data .....	256
Customer information .....	266
Index .....	272

# Introduction

Fuel	Designation	<input type="text"/>		
Engine oil	Grade	<input type="text"/>		
	Viscosity	<input type="text"/>		
Tyre pressure	Tyre size		Front	Rear
	Summer tyres	<input type="text"/>	<input type="text"/>	<input type="text"/>
	Winter tyres	<input type="text"/>	<input type="text"/>	<input type="text"/>
Weights	Gross vehicle weight rating	<input type="text"/>		
	- Kerb weight, basic model	<input type="text"/>		
	= Loading	<input type="text"/>		

## Vehicle specific data

Please enter your vehicle's data on the previous page to keep it easily accessible.

Refer to the sections "Service and maintenance", "Technical data", the vehicle's identification plate and national registration documents.

## Introduction

Your vehicle is a designed combination of advanced technology, safety, environmental friendliness and economy.

This Owner's Manual provides you with all the necessary information to enable you to drive your vehicle safely and efficiently.

Make sure your passengers are aware of the possible risk of accident and injury which may result from improper use of the vehicle.

You must always comply with the specific laws and regulations of the country that you are in. These laws may differ from the information in this Owner's Manual.

Disregarding the description given in this manual may affect your warranty.

When this Owner's Manual refers to a workshop visit, we recommend your Vauxhall Authorised Repairer.

All Vauxhall Authorised Repairers provide first-class service at reasonable prices. Experienced mechanics trained by Vauxhall work according to specific Vauxhall instructions.

The customer literature pack should always be kept ready to hand in the vehicle.

## Using this manual

- This manual describes all options and features available for this model. **Certain descriptions, including those for display and menu functions, may not apply to your vehicle due to model variant, country specifications, special equipment or accessories.**
- The "In brief" section will give you an initial overview.

- The table of contents at the beginning of this manual and within each section shows where the information is located.
- The index will enable you to search for specific information.
- This Owner's Manual depicts left-hand drive vehicles. Operation is similar for right-hand drive vehicles.
- The Owner's Manual uses the engine identifier code. The corresponding sales designation and engineering code can be found in the section "Technical data".
- Directional data, e.g. left or right, or front or back, always relate to the direction of travel.
- Displays may not support your specific language.
- Display messages and interior labelling are written in **bold** letters.

## Danger, Warnings and Cautions

### **⚠ Danger**

Text marked **⚠ Danger** provides information on risk of fatal injury. Disregarding this information may endanger life.

### **⚠ Warning**

Text marked **⚠ Warning** provides information on risk of accident or injury. Disregarding this information may lead to injury.

### **Caution**

Text marked **Caution** provides information on possible damage to the vehicle. Disregarding this information may lead to vehicle damage.

## Symbols

Page references are indicated with ⇨. ⇨ means "see page".

Page references and index entries refer to the indented headings given in the section table of content.

Thank you for choosing a Vauxhall.

We wish you many hours of pleasurable driving.

**Your Vauxhall Team**



## In brief

### Initial drive information

#### Vehicle unlocking



Press  to unlock the vehicle. Open the doors by pulling the handles.

#### Tailgate

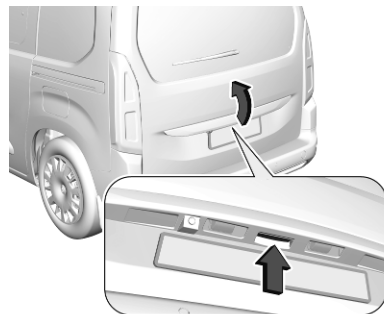

After unlocking, press the tailgate button and open the tailgate.

Radio remote control ⇨ 21.

Central locking system ⇨ 24.

Electronic key system ⇨ 22.

Load compartment ⇨ 31.

Rear doors ⇨ 30

Sliding door ⇨ 29



## Seat adjustment

### Longitudinal adjustment



Pull handle, slide seat, release handle. Try to move the seat back and forth to ensure that the seat is locked in place.

Seat position ⇄ 45

Seat adjustment ⇄ 46

### Backrests inclination



Push the lever and adjust the inclination. Do not lean on backrest when adjusting.

Seat position ⇄ 45

Seat adjustment ⇄ 46

### Seat height

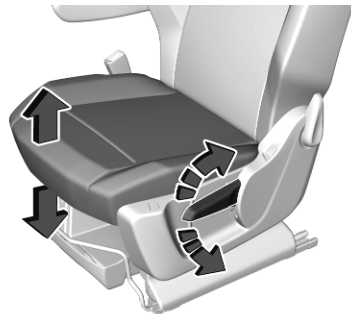

Lever pumping motion

up : seat higher

down : seat lower

Seat position ⇄ 45

Seat adjustment ⇄ 46

## Head restraint adjustment

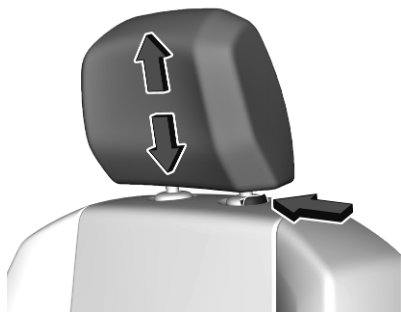

Press release button, adjust height, engage.

Head restraints ⇨ 44.

## Seat belt



Pull out the seat belt and fasten in seat belt buckle. The seat belt must not be twisted and must fit close against the body. The backrest must not be tilted back too far (maximum approx. 25°).

To unfasten seat belt, press red button on belt buckle.

Seat position ⇨ 45.

Seat belts ⇨ 54.

Airbag system ⇨ 57.

## Mirror adjustment

### Interior mirror



To adjust the mirror, move the mirror housing in the desired direction.

Manual anti-dazzle interior mirror ⇨ 38.

Automatic anti-dazzle interior mirror ⇨ 39.

## Exterior mirrors

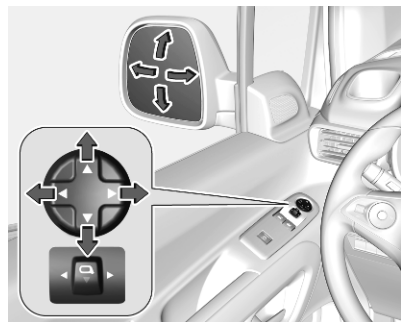

Select the relevant exterior mirror by pushing the mirror button to the left or right. Adjust respective mirror by the four-way control.

Convex mirrors ⇨ 37.

Electric adjustment ⇨ 37.

Folding mirrors ⇨ 37.

Heated mirrors ⇨ 38.

## Steering wheel adjustment

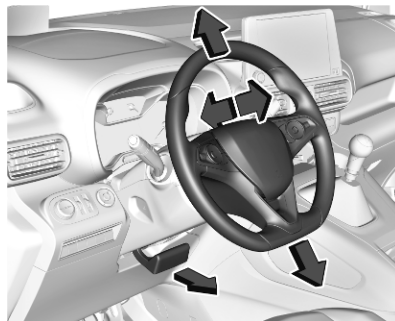

Unlock lever, adjust steering wheel, then engage lever and ensure it is fully locked. Do not adjust steering wheel unless vehicle is stationary and steering wheel lock has been released.

Seat position ⇨ 45.

Ignition positions ⇨ 143.

## Instrument panel overview

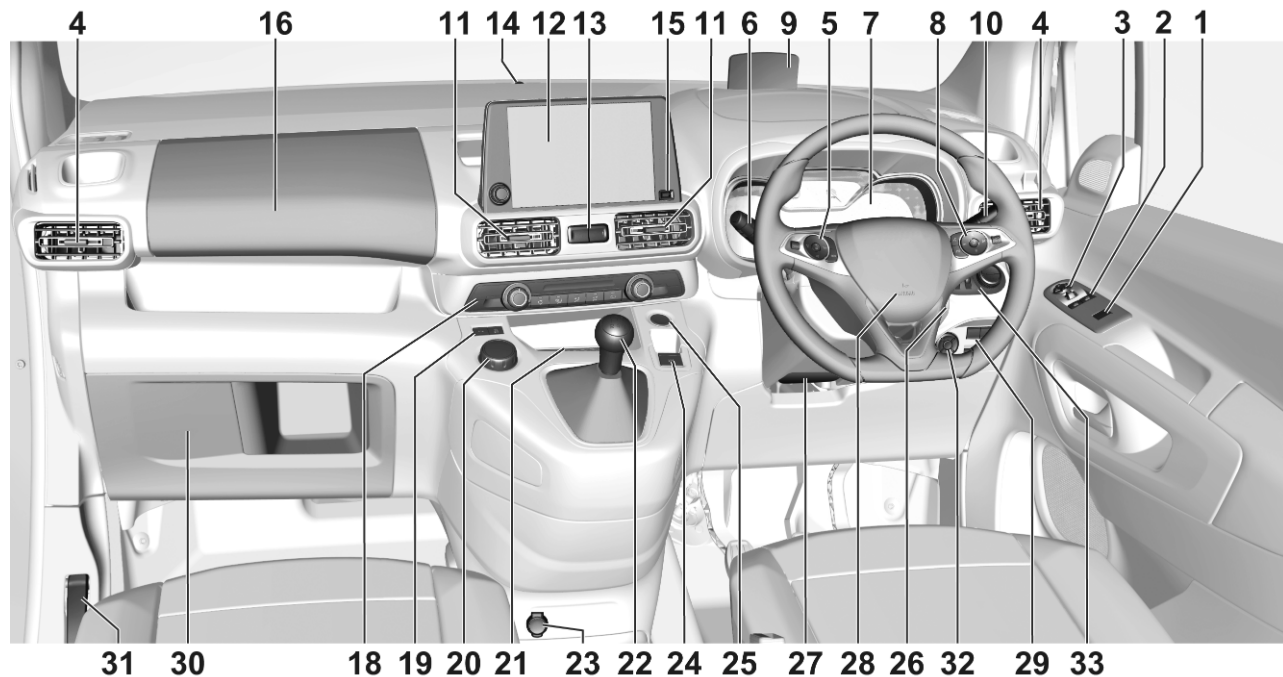

<p><b>1</b> Electric child locks ..... 27</p> <p style="padding-left: 20px;">Unlocking tailgate ..... 31</p> <p style="padding-left: 20px;">Child safety system for rear windows ..... 40</p> <p><b>2</b> Power windows ..... 40</p> <p><b>3</b> Exterior mirrors ..... 37</p> <p><b>4</b> Side air vents ..... 140</p> <p><b>5</b> Cruise control ..... 167</p> <p style="padding-left: 20px;">Speed limiter ..... 169</p> <p style="padding-left: 20px;">Adaptive cruise control ..... 167</p> <p><b>6</b> Turn lights ..... 125</p> <p style="padding-left: 20px;">Headlight flash ..... 123</p> <p style="padding-left: 20px;">High beam ..... 122</p> <p style="padding-left: 20px;">High beam assist ..... 122</p> <p style="padding-left: 20px;">Exit lighting ..... 128</p> <p style="padding-left: 20px;">Parking lights ..... 126</p> <p style="padding-left: 20px;">Buttons for Driver Information Centre ..... 108</p> <p><b>7</b> Instruments ..... 97</p> <p style="padding-left: 20px;">Driver Information Centre .... 108</p> <p><b>8</b> Infotainment controls</p>	<p><b>9</b> Head-up display ..... 112</p> <p><b>10</b> Windscreen wiper and washer, rear wiper and washer ..... 90</p> <p><b>11</b> Air vents ..... 140</p> <p><b>12</b> Info Display ..... 110</p> <p><b>13</b> Hazard warning flashers .... 124</p> <p style="padding-left: 20px;">Central locking system ..... 24</p> <p><b>14</b> Anti-theft alarm system status LED ..... 34</p> <p><b>15</b> USB charging port ..... 93</p> <p><b>16</b> Storage ..... 69</p> <p><b>18</b> Climate control system ..... 131</p> <p><b>19</b> Electronic Stability Control and Traction Control ..... 163</p> <p style="padding-left: 20px;">Eco mode ..... 157</p> <p style="padding-left: 20px;">Descent control system ..... 164</p> <p><b>20</b> Selective ride control ..... 165</p> <p><b>21</b> Inductive charging ..... 94</p> <p><b>22</b> Manual transmission ..... 158</p> <p style="padding-left: 20px;">Automatic transmission ..... 155</p> <p><b>23</b> Power outlet ..... 93</p> <p><b>24</b> Electric parking brake ..... 160</p>	<p><b>25</b> Power button ..... 144</p> <p><b>26</b> Ignition switch ..... 143</p> <p><b>27</b> Steering wheel adjustment . . 89</p> <p><b>28</b> Horn ..... 90</p> <p><b>29</b> Parking assist / Advanced parking assist ..... 183</p> <p style="padding-left: 20px;">Electric child locks ..... 27</p> <p style="padding-left: 20px;">Eco button for stop-start system ..... 147</p> <p style="padding-left: 20px;">Lane keep assist ..... 198</p> <p style="padding-left: 20px;">Tyre deflation detection system ..... 233</p> <p style="padding-left: 20px;">Parking heater ..... 138</p> <p><b>30</b> Fuse box ..... 229</p> <p><b>31</b> Bonnet release lever ..... 213</p> <p><b>32</b> Head-up display ..... 112</p> <p><b>33</b> Light switch ..... 121</p> <p style="padding-left: 20px;">Front / rear fog lights ..... 125</p> <p style="padding-left: 20px;">Instrument illumination ..... 126</p>
---	---	--

## Exterior lighting



**AUTO** : automatic light control  
switches automatically  
between daytime running  
light and headlight

**D** : sidelights

**D** : headlights

Automatic light control ⇨ 122.

Front fog lights ⇨ 125.

Rear fog light ⇨ 125.

## Headlight flash and high beam

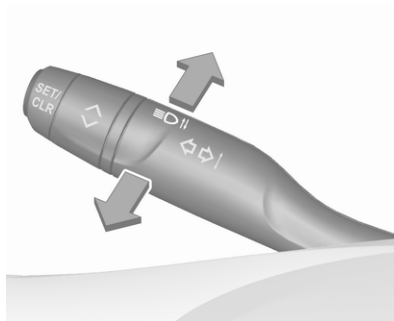

pull : headlight flash

push : high beam

High beam ⇨ 122.

High beam assist ⇨ 122.

Headlight flash ⇨ 123.

## Turn lights

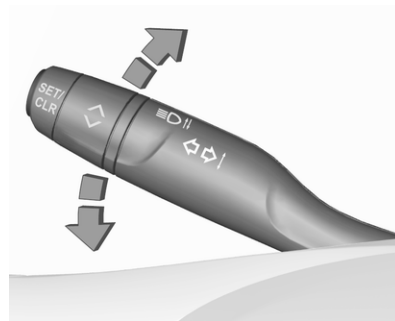

up : right turn light

down : left turn light

Turn lights ⇨ 125.

Parking lights ⇨ 126.

### Hazard warning flashers

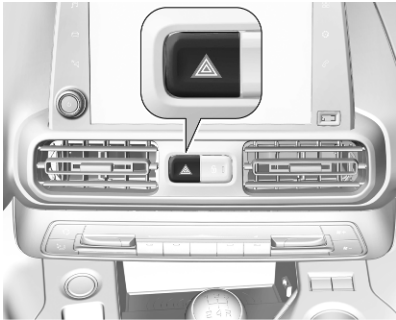

Operated by pressing .  
 Hazard warning flashers ⇨ 124.

### Horn

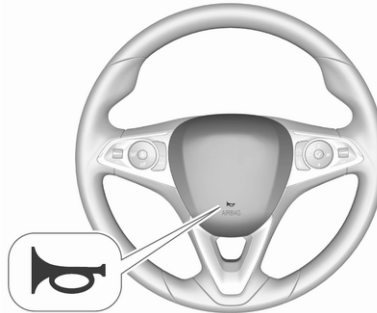

Press .

### Washer and wiper systems

#### Windscreen wiper



- HI : fast
- LO : slow
- INT : interval wiping
- OFF : off

For single wipe when the wiper is off, press down to position **1x**.

Windscreen wiper ⇨ 90.

## Windscreen washer



Pull.

Windscreen washer system ⇨ 90.

Washer fluid ⇨ 216.

Wiper blade replacement ⇨ 219.

## Rear window wiper



**OFF** : off

**INT** : intermittent operation

## Rear window washer



Push.

Washer fluid is sprayed on the rear window and the wiper wipes a few times.

Rear window wiper / washer ⇨ 92.



## Climate control

### Heated rear window

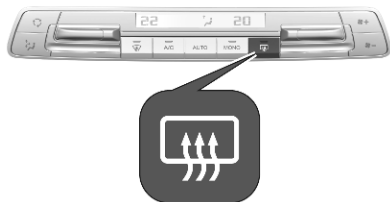



The heating is operated by pressing .

Heated rear window ⇨ 42.

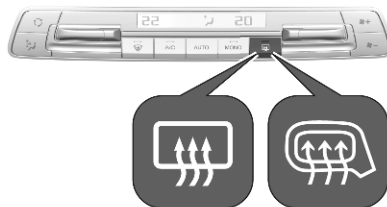
### Heated exterior mirrors



Depending on the version, heating is operated by pressing  or .



Heating works with the engine running and is switched off automatically after a short time.

Heated exterior mirrors ⇨ 38.

### Demisting and defrosting the windows

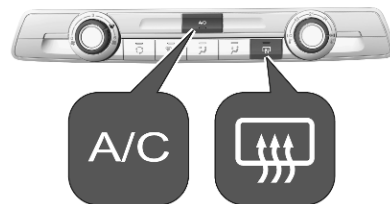
### Heating and ventilation system, air conditioning system



- Set fan speed  to highest level.
- Set temperature controller  to warmest level.
- Switch on cooling **A/C**, if required.
- Switch on heated rear window .
- Open side air vents as required and direct them towards the door windows.

**Notice**

If the settings for demisting and defrosting are selected, an Autostop may be inhibited.

If the settings for demisting and defrosting are selected while the engine is in an Autostop, the engine will restart automatically. Stop-start system ⇨ 147.

Heating and ventilation system ⇨ 130.

Air conditioning system ⇨ 131.

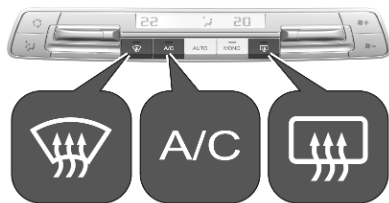
**Electronic climate control system**

- Press . The LED in the button illuminates to indicate activation.
- Air conditioning and automatic mode are automatically switched on. The LED in the button **A/C** illuminates, **AUTO** is shown in the display.
- Temperature and air distribution are set automatically and the fan runs at high speed.
- Switch on heated rear window .

- Switch on heated windscreen if available.
- To return to previous mode, press again.

**Notice**

If is pressed while the engine is running, an Autostop will be inhibited until is pressed again.

If is pressed while the engine is in an Autostop, the engine will restart automatically.

Electronic climate control system ⇨ 134.

## Transmission

### Manual transmission

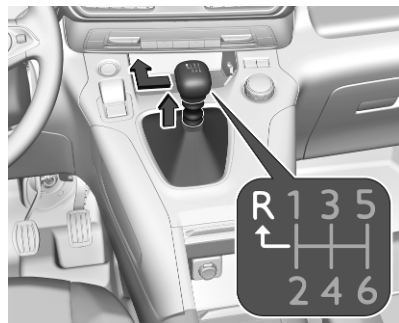

To engage reverse on 6-speed transmission, depress the clutch pedal, pull the ring under the selector lever and move the selector lever quite to the left and front.

Manual transmission ⇨ 158.

### Automatic transmission

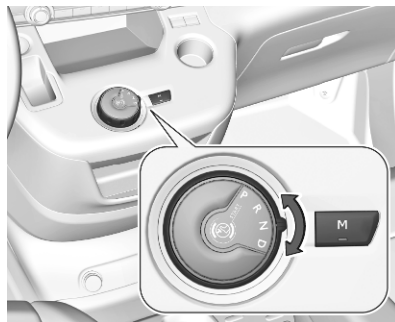

**P** : park position

**R** : reverse

**N** : neutral

**D** : automatic mode

**M** : manual mode

Automatic transmission ⇨ 155.

## Starting off

### Check before starting off

- tyre pressure ⇨ 232 and condition ⇨ 263
- engine oil level and fluid levels ⇨ 214
- all windows, mirrors, exterior lighting and number plates are free from dirt, snow and ice and are operational
- proper position of mirrors ⇨ 37, seats ⇨ 45 and seat belts ⇨ 55
- brake function at low speed, particularly if the brakes are wet

## Starting the engine

### Ignition switch

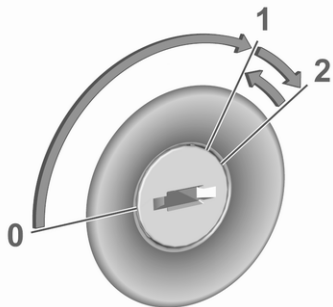

- turn key to position 1
- move the steering wheel slightly to release the steering wheel lock
- manual transmission: operate clutch and brake pedal  
automatic transmission: operate brake pedal and move selector lever to **P** or **N**
- do not operate accelerator pedal

- Diesel engine: wait until control indicator  for preheating extinguishes
- turn key to position 2 and release after engine has been started

Starting the engine ⇨ 145.

### Start power button

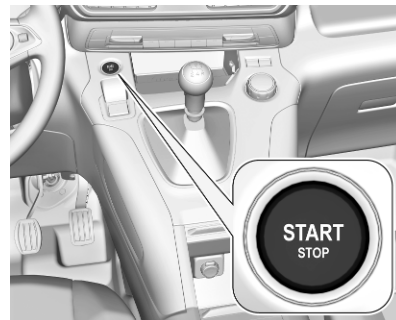

- manual transmission: operate clutch and brake pedal
- automatic transmission: operate brake pedal and move selector lever to **P** or **N**
- do not operate accelerator pedal
- press **Start/Stop** button
- release button after starting procedure begins

## Stop-start system



If the vehicle is at a low speed or at a standstill and certain conditions are fulfilled, an Autostop is activated.

An Autostop is indicated by control indicator (A).

Manual transmission: to restart the engine, depress the clutch pedal again. Control indicator (A) extinguishes.

Automatic transmission: to restart the engine, release the brake pedal. Control indicator (A) extinguishes.

Stop-start system ⇨ 147.

## Parking

### ⚠ Warning

- Do not park the vehicle on an easily ignitable surface. The high temperature of the exhaust system could ignite the surface.
- Always apply the parking brake.
- If the vehicle is on a level surface or uphill slope, engage first gear or set the selector lever to position **P**. On an uphill slope, turn the front wheels away from the kerb.

If the vehicle is on a downhill slope, engage reverse gear or set the selector lever to position **P**. Turn the front wheels towards the kerb.

- Close the windows.
- Switch off the engine.
- Remove the ignition key from the ignition switch or switch off ignition on vehicles with power

button. Turn the steering wheel until the steering wheel lock is felt to engage.

- Lock the vehicle with  on the radio remote control. Activate the anti-theft alarm system ⇨ 34.
- The engine cooling fans may run after the engine has been switched off ⇨ 213.

### Caution

After running at high engine speeds or with high engine loads, operate the engine briefly at a low load or run in neutral for approx. 30 seconds before switching off, in order to protect the turbocharger.

Keys, locks ⇨ 20.

Laying-up the vehicle for a long period of time ⇨ 212.

## Keys, doors and windows

<b>Keys, locks</b> .....	<b>20</b>
Keys .....	20
Radio remote control .....	21
Electronic key system .....	22
Central locking system .....	24
Automatic locking .....	27
Child locks .....	27
<b>Doors</b> .....	<b>29</b>
Sliding door .....	29
Rear doors .....	30
Load compartment .....	31
<b>Vehicle security</b> .....	<b>34</b>
Anti-theft locking system .....	34
Anti-theft alarm system .....	34
Immobiliser .....	36
<b>Exterior mirrors</b> .....	<b>37</b>
Convex shape .....	37
Electric adjustment .....	37
Folding mirrors .....	37
Heated mirrors .....	38
<b>Interior mirrors</b> .....	<b>38</b>
Manual anti-dazzle .....	38
Automatic anti-dazzle .....	39

Child surveillance mirror .....	39
Rear view display .....	39
<b>Windows</b> .....	<b>40</b>
Windscreen .....	40
Power windows .....	40
Rear windows .....	42
Heated rear window .....	42
Sun visors .....	43
Roller blinds .....	43
<b>Roof</b> .....	<b>43</b>
Glass panel .....	43

## Keys, locks

### Keys

<b>Caution</b>
Do not attach heavy or bulky items to the ignition key.

### Replacement keys

The key number is specified on a detachable tag.

The key number must be quoted when ordering replacement keys as it is a component of the immobiliser system.

Locks ⇨ 247.

Central locking ⇨ 24.

Starting the engine ⇨ 145.

Radio remote control ⇨ 21.

Electronic key ⇨ 22.

The code number of the adapter for the locking wheel nuts is specified on a card. It must be quoted when ordering a replacement adapter.

Wheel changing ⇨ 238.

### Key with foldaway key section



Press button to extend. To fold the key, first press the button.

### Lock cylinders

Designed to free-wheel if they are forcefully rotated without the correct key or if the correct key is not fully inserted. To reset, turn cylinder with the correct key until its slot is vertical, remove key then re-insert it. If the cylinder still free-wheels, turn the key through 180° and repeat operation.

### Radio remote control



Depending on the version, the radio remote control enables a operation of the following functions:

- central locking system ⇄ 24
- anti-theft locking system ⇄ 34
- anti-theft alarm system ⇄ 34
- tailgate unlocking ⇄ 24
- power windows ⇄ 40
- mirrors folding ⇄ 37
- vehicle locator lighting ⇄ 129
- peripheral lighting ⇄ 129

The remote control has a range of up to several metres, but may also be much less due to external influences. The hazard warning flashers confirm operation.

Handle with care, protect from moisture and high temperatures and avoid unnecessary operation.

### Replacing battery in radio remote control

Replace the battery as soon as the range reduces.



Batteries do not belong in household waste. They must be disposed of at an appropriate recycling collection point.

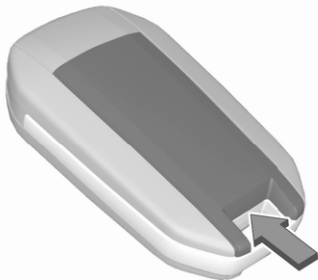

1. Remove the back cover from the remote control.
2. Extract the flat battery from its location.

3. Replace battery with a battery of the same type. Pay attention to the installation position.
4. Clip the back cover in place.

### Fault

If the central locking system cannot be operated with the radio remote control, the cause may be one of the following:

- Fault in radio remote control.
- Electronic key is out of reception range.
- The battery voltage is too low.
- Overload of the central locking system by operating at frequent intervals, the power supply is interrupted for a short time.
- Interference from higher-power radio waves from other sources.

Manual unlocking ⇨ 24.

### Electronic key system





Depending on the version, the electronic key system enables a keyless operation of the following functions:

- central locking system ⇨ 24
- tailgate unlocking
- ignition switching on and starting the engine ⇨ 145
- headlight activation

The electronic key simply needs to be on the driver's person.

Additionally, the electronic key includes the functionality of the radio remote control ⇨ 21.

Handle with care, protect from moisture and high temperatures and avoid unnecessary operation.

#### Notice

To save battery power, the keyless functions are set to stand-by after 21 days of non-use. To reactivate the functions, press a button on the electronic key.

### Replacing battery in electronic key

Replace the battery as soon as the system no longer operates properly or the range is reduced.



Batteries do not belong in household waste. They must be disposed of at an appropriate recycling collection point.



1. Remove the cover.
2. Extract the flat battery from its location.
3. Replace battery with a battery of the same type. Pay attention to the installation position.
4. Clip the cover in place.

### Fault

If the central locking cannot be operated or the engine cannot be started, the cause may be one of the following:

- Fault in electronic key.
- Electronic key is out of reception range.
- The battery voltage is too low.
- Overload of the central locking system by operating at frequent intervals, the power supply is interrupted for a short time.
- Interference from higher-power radio waves from other sources.

To rectify the cause of the fault, change the position of the electronic key.

Manual unlocking ⇨ 24.

## Central locking system

Unlocks and locks doors, load compartment and fuel filler flap.

A pull on an interior door handle unlocks and opens the respective door.

### Notice

In the event of an accident in which airbags or belt pretensioners are deployed, the vehicle is automatically unlocked.

### Notice

A short time after unlocking with the remote control the doors are locked automatically if no door has been opened. A precondition is that the setting is activated in the vehicle personalisation ⇨ 115.

## Selective unlocking of cabin and load compartment

Selective unlocking allows you to unlock either the doors of the cabin and the fuel filler flap or the load compartment, i.e., sliding doors, rear door / tailgate. Selective unlocking has to be configured.

Graphic Info Display: Switch on ignition. Press  more than 2 seconds. An audible signal is given and a message is displayed in the Graphic Info Display.

Colour Info Display: Select the relevant setting in the Vehicle personalisation.

Vehicle personalisation ⇨ 115.



## Remote control operation

### Unlocking





Press .

Unlocking mode can be set. Two settings are selectable:

- All doors and load compartment will be unlocked by pressing .
- Only the driver's door and the passenger door will be unlocked by pressing .

### Unlocking the load compartment

Press  or press  two times to unlock the load compartment only, i.e., sliding doors and rear doors or tailgate.

### Locking

Close doors and the load compartment.



Press .

If the vehicle is not closed properly, the central locking system will not work.

### Confirmation

Operation of the central locking system is confirmed by the hazard warning flashers. A precondition is that the setting is activated in the vehicle personalisation  115.

### Electronic key system operation

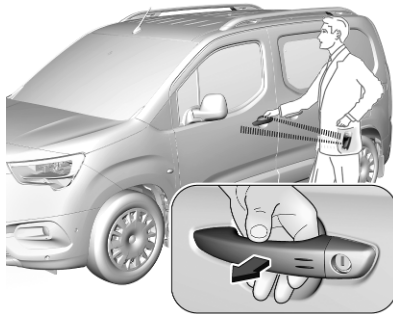

The electronic key must be outside the vehicle, within a range of approx. one metre of the relevant door side.

### Unlocking

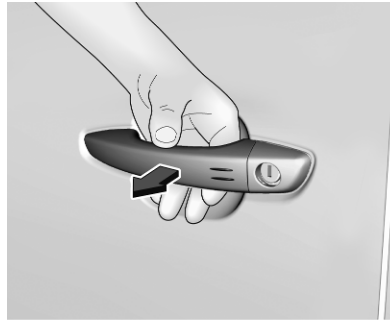

Pass a hand behind the door handle of one of the front doors or the rear door to unlock the vehicle or press the middle tailgate button.

Keep the hand behind the door handle or keep the tailgate button pressed to open the windows.

Unlocking mode can be set in the vehicle personalisation menu in the Info Display. Two settings are selectable:

- All doors, load compartment and fuel filler flap will be unlocked by passing a hand behind one of the front door handles or the handle

of the rear door. If the vehicle is equipped with a tailgate, press the tailgate button.

- Only the front doors and the fuel filler flap will be unlocked by passing a hand behind one of front door handles.

Vehicle personalisation  115.

### Unlocking the load compartment

Only the load compartment, i.e., the rear door or the tailgate, will be unlocked by passing a hand behind the rear door handle or pressing the tailgate button.

### Locking

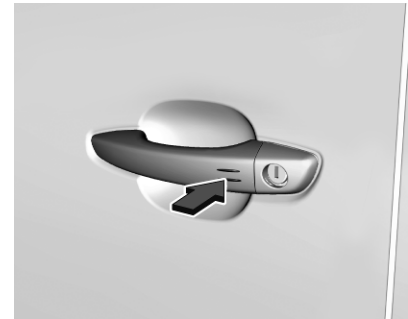

Press with a finger or thumb on one of the door handles (at the markings) or press the tailgate button.

All doors, load compartment and fuel filler flap will be locked.

If the vehicle is not closed properly, the electronic key remains in the vehicle or the ignition is not off, locking will not be permitted.

### Confirmation

Operation of central locking system is confirmed by the hazard warning flashers.

### Central locking button

Locks or unlocks all doors and the load compartment from inside the passenger compartment. If the vehicle is equipped with electronic key system, the fuel filler flap is locked or unlocked, too.



Press  to lock. The LED in the button illuminates.

Press  again to unlock. The LED in the button extinguishes.

### Operation with the key in case of a central locking system fault

In case of a fault, e.g. vehicle battery or remote control / electronic key battery is discharged, the driver's door can be locked or unlocked with the mechanical key.

### Manual unlocking

Electronic key: press and hold the latch to extract the integral key.

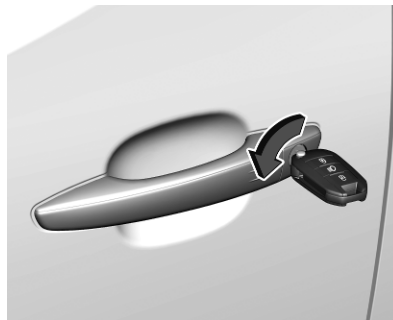

Manually unlock the driver's door by inserting and turning the key in the lock cylinder.

The other doors can be opened by pulling the interior handle.

By switching on the ignition, the anti-theft locking system is deactivated.

## Manual locking

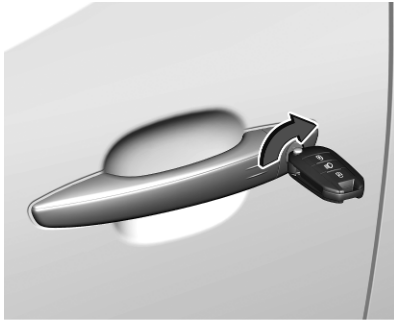

Manually lock the doors, tailgate and fuel filler flap by inserting and turning the key in the lock cylinder of the driver's door.

## Automatic locking

### Automatic locking after driving off

This system allows automatic locking of the doors and the tailgate as soon as the speed of the vehicle exceeds 6 mph.

If one of the doors or the tailgate is open, the automatic central locking does not take place. This is signalled

by the sound of the locks rebounding, accompanied by illumination of  in the instrument cluster, an audible signal and the display of an alert message.



This function can be activated or deactivated at any time. With the ignition on, press  until an audible signal starts and a corresponding message is displayed.

The state of the system stays in memory when switching off the ignition.

## Automatic relock after unlocking

This feature automatically locks all doors, load compartment and fuel filler flap a short time after unlocking with the remote control or electronic key, provided no door has been opened.

## Child locks

### Warning

Use the child locks whenever children are occupying the rear seats.

### Mechanical child locks

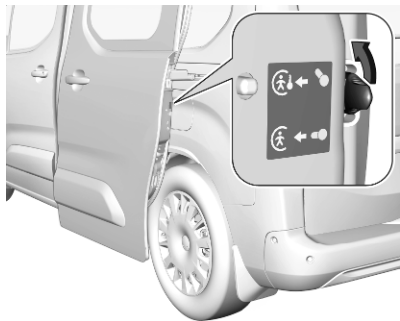

Turn the child lock in the rear door to the vertical position. The door cannot be opened from the inside.

To deactivate, turn the child lock to the horizontal position.

### Electric child locks



Depending on version, the  button may be located in the driver's door or below the light switch.

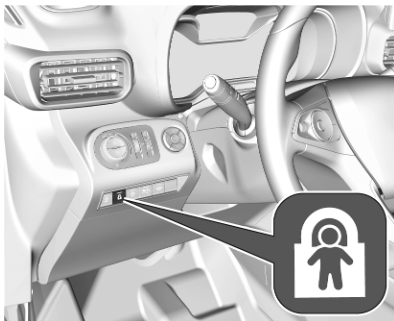

Remotely operated system to prevent opening of the rear doors via the interior door handles and the use of the rear power windows.

#### Switching on

Press . The indicator light of the button comes on, accompanied by a confirmation message. This indicator light remains on until the child lock is switched off.

#### Switching off

Press  again. The indicator light on button goes off, accompanied by a confirmation message. This indicator light remains on while child lock is switched on.

## Doors

### Sliding door

#### Opening

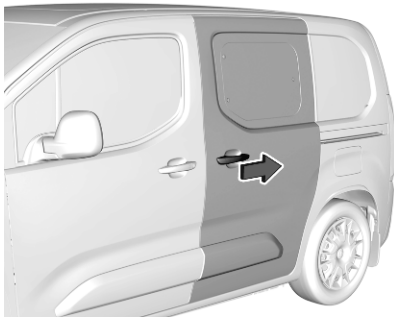

After unlocking, pull the outside door handle and slide the door towards the rear beyond the point of resistance.

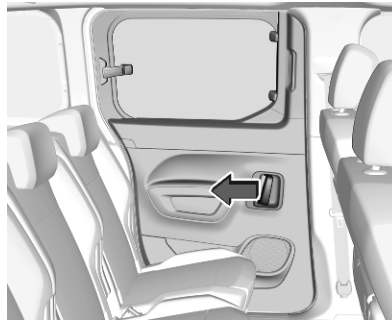

To open from inside push the handle and slide the door towards the rear beyond the point of resistance.

#### Closing

To close from outside pull the door handle and slide the door towards the front until it locks.

To close from inside push the handle and slide the door beyond the point of resistance. Then, use the shaped recess at the top of the door pillar to slide the door towards the front until it locks.

#### Caution

Ensure the sliding side door is fully closed and secure before driving the vehicle.

#### Caution

To avoid damage, do not attempt to operate the sliding side door when the fuel filler flap is open.

#### **⚠ Danger**

Do not drive with the sliding side door open or ajar, e.g. when transporting bulky objects, since toxic exhaust gases, which cannot be seen or smelled, could enter the vehicle. This can cause unconsciousness and even death.

Refuelling ⇨ 204.

## Rear doors

Unlock the rear doors with the remote control or by turning the key in the rear door lock cylinder.

Central locking ⇨ 24.

Always open the left hand door before the right hand door.



To open the left hand rear door, pull the exterior handle.



The door is opened from inside the vehicle by pulling the interior handle.

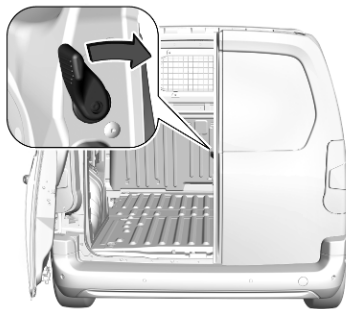

The right hand rear door is released using the lever.

### ⚠ Warning

The rear lights may be obscured if the rear doors are open and the vehicle is parked on the roadside.

Make other road users aware of the vehicle, by using a warning triangle or other equipment specified in the road traffic regulations.



The doors are retained in the 90° position by locking stays. To open the doors to 180°, push the latch and swing open to the desired position.



Before closing the doors ensure that the locking stays are in the 90° position.

### ⚠ Warning

Ensure extended opening doors are secured when fully opened.

Opened doors may slam closed due to the force of the wind!

Always close the right hand door before the left hand door.

Central locking system ⇨ 24.

### Driving with an open load compartment

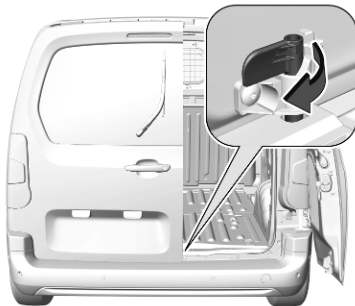

In exceptional cases only, it is possible to drive with the right-hand rear door open, e.g. if long objects need to be transported. Open the left-hand followed by the right-hand rear door, then close the left-hand rear door and lock it.

### ⚠ Danger

Engine exhaust gases contain poisonous carbon monoxide, which is colourless and odourless and could be fatal if inhaled.

When driving with an open load compartment, exhaust gases could enter the vehicle. Open the windows.

### Notice

Do not use the left-hand rear door to hold objects in place.

If possible, secure objects with lashing straps attached to lashing eyes ⇨ 78.

### Caution

Always make sure that the load in the vehicle is securely stowed when driving with an open load compartment.

For further information, refer to "Loading information" ⇨ 85.

Always comply with local or national regulations.

## Load compartment

### Tailgate

### Opening

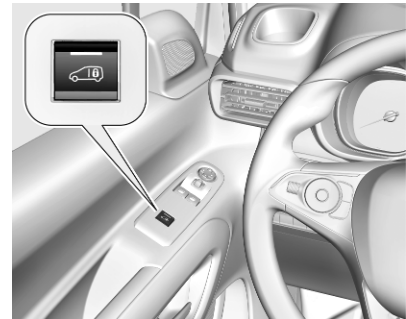

Depending on the version, press  to unlock the tailgate.

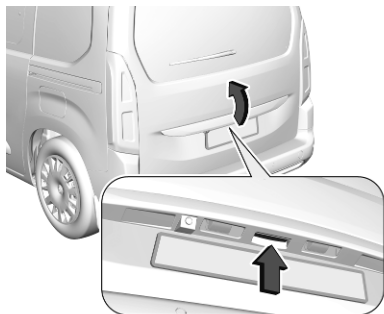

After unlocking, press the middle tailgate button and open the tailgate.

### Closing



Use the interior handle.

Do not push the middle tailgate button whilst closing as this will unlock the tailgate again.

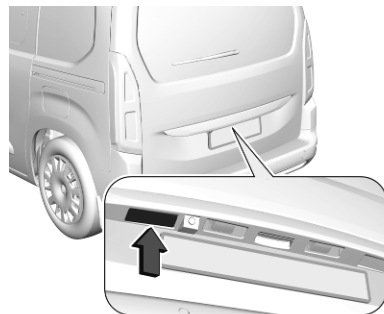

With the electronic key outside the vehicle and within a range of approx. one metre of the tailgate, press the left tailgate button to lock the vehicle. Central locking system ↗ 24.

### General hints for operating tailgate

#### Danger

Do not drive with the tailgate open or ajar, e.g. when transporting bulky objects, since toxic exhaust gases, which cannot be seen or

smelled, could enter the vehicle. This can cause unconsciousness and even death.

### Caution

Before opening the tailgate, check overhead obstructions, e.g. a garage door, to avoid damage to the tailgate. Always check the moving area above and behind the tailgate.

### Notice

The installation of certain heavy accessories onto the tailgate may affect its ability to remain open.

### Notice

At low outside temperatures the tailgate may not open fully by itself. In this case lift the tailgate manually to its normal end position.

### Emergency tailgate opening from inside the vehicle

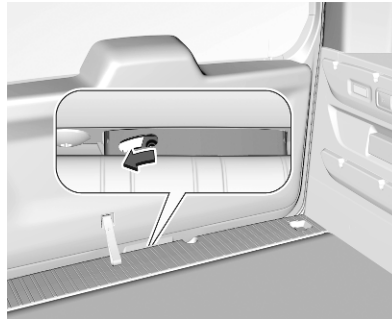

An access hole between the door and the floor enables the tailgate latch to be released using a suitable tool. Push lever to the left to unlock and open the tailgate.

### Rear window

The rear window can be opened to give access to the load compartment without opening the tailgate.

The tailgate and the rear window cannot be opened at the same time.

### Opening



After unlocking, press the right tailgate button and open the rear window.

### Closing

Press on the centre of the rear window until it is fully closed.

## Vehicle security

### Anti-theft locking system

#### ⚠ Warning

Do not use the system if there are people in the vehicle! The doors cannot be unlocked from the inside.

The system deadlocks all the doors. All doors must be closed otherwise the system cannot be activated.

Unlocking the vehicle disables the mechanical anti-theft locking system. This is not possible with the central locking button.

#### Activating

Simple key: Insert the key and turn it clockwise twice within 5 seconds.

Remote control: Press  on the radio remote control twice within five seconds.

Electronic key: Press twice with a finger or thumb on one of the door handles (at the markings) within five seconds

### Anti-theft alarm system

The anti-theft alarm system is combined with the central locking system.

It monitors:

- doors, tailgate, bonnet
- passenger compartment including adjoining load compartment

#### Activation

Ignition must be switched off. All doors must be closed and the electronic key must not remain in the vehicle. Otherwise the system cannot be activated.

- Radio remote control: Monitoring of doors, tailgate and bonnet is activated 5 seconds after locking the vehicle by pressing . Monitoring of passenger compartment including adjoining

load compartment is activated 45 seconds after locking the vehicle by pressing .

- Electronic key system: Monitoring of doors, tailgate and bonnet is activated 5 seconds after locking the vehicle by pressing with a finger or thumb on one of the front door handles at the markings. Monitoring of passenger compartment including adjoining load compartment is activated 45 seconds after locking the vehicle by pressing with a finger or thumb on one of the front door handles at the markings.

Activation is confirmed by the flashing of the status LED and coming on of the turn lights for a short time.

If a door or the tailgate is not correctly closed and the vehicle is locked via remote control or electronic key system, the vehicle remains unlocked. However, the anti-theft alarm system will be activated after 45 seconds.

**Notice**

Changes to the vehicle interior such as the use of seat covers and open windows, could impair the function of passenger compartment monitoring.

**Activation without monitoring of passenger compartment**

Switch off the monitoring of passenger compartment when animals are being left in the vehicle, because of high volume ultrasonic signals or movements triggering the alarm. Also switch off when the vehicle is on a ferry or train.

1. Switch of ignition.
2. Press  within the next 10 seconds until the LED of the button illuminates constantly.
3. Get out of the vehicle.
4. Lock the vehicle immediately by using the remote control, pressing with a finger or thumb on one of the door handles (at the markings) or pressing the tailgate button.

Activation is indicated by the flashing of the status LED.

**Indication**

LED in the central locking button flashes if the anti-theft alarm system is activated.

Seek the assistance of a workshop in the event of faults.

**Deactivation**

Radio remote control: Unlocking the vehicle by pressing  deactivates the anti-theft alarm system.

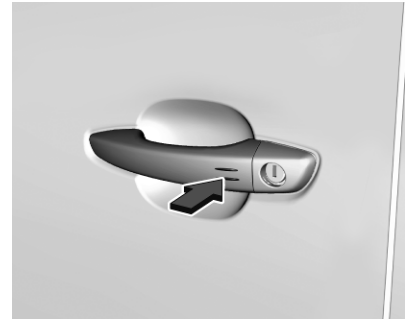

Electronic key system: Unlocking the vehicle by pressing on one of the front door handles at the markings deactivates the anti-theft alarm system.

The electronic key must be outside the vehicle, within a range of approx. one metre of the relevant door side.



The system is not deactivated by unlocking the driver's door with the key or with the central locking button in the passenger compartment.

**Notice**

If the vehicle is unlocked and no door is opened, the vehicle is automatically relocked after 30 seconds. In this case, the anti-theft alarm will be reactivated, too.

**Alarm**

When triggered, the alarm horn sounds and the hazard warning lights flash simultaneously. The number and duration of alarm signals are stipulated by legislation.

The anti-theft alarm system can be deactivated by pressing , by pressing on one of the front door handles at the markings with electronic key system. The LED of the  button will extinguish and the turn lights flash for a short time.

A triggered alarm, which has not been interrupted by the driver, will be indicated by the rapid flashing of the LED of the  button. If the ignition is switched on, the flashing stops immediately

If the vehicle's battery is to be disconnected (e.g. for maintenance work), the alarm siren must be

deactivated as follows: switch the ignition on then off, then disconnect the vehicle's battery within 15 s

If the battery has been reconnected (e.g. after maintenance work), wait for 10 minutes to restart the engine.

**Locking the vehicle without activation of the anti-theft alarm**

Lock the vehicle by inserting and turning the integrated key of the remote control or the electronic key system in the lock cylinder of the driver's door.

**Malfunction of the remote control**

Unlock the vehicle by inserting and turning the integrated key of the remote control or the electronic key system in the lock cylinder of the driver's door.

Open the driver's door.

The horn of the anti-theft alarm will sound.

Switch on ignition.

The horn will stop sounding and the status LED extinguishes.

**Immobiliser**

The system is part of the ignition switch and checks whether the vehicle is allowed to be started with the key being used.

The immobiliser is activated automatically after the key has been removed from the ignition switch.

**Notice**

Radio Frequency Identification (RFID) tags may cause interference with the key. Do not have it placed near the key when starting the vehicle.

**Notice**

The immobiliser does not lock the doors. Always lock the vehicle after leaving it .

Switch on the anti-theft alarm system  34.

Emergency operation of electronic key  144.

## Exterior mirrors

### Convex shape

The shape of the mirror makes objects appear smaller, which will affect the ability to estimate distances.

Side blind spot alert ⇨ 191.

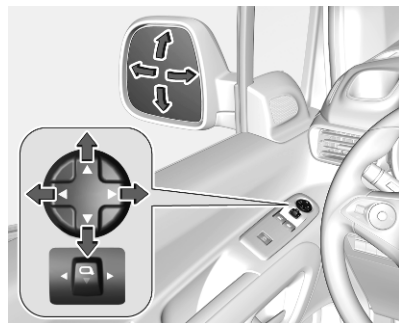

### Electric adjustment

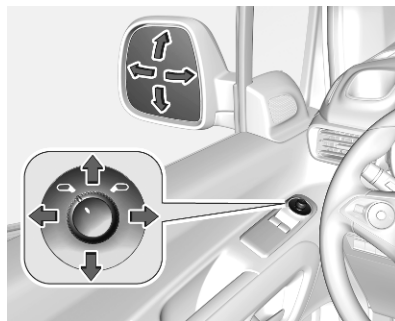

Select the relevant exterior mirror by pushing the mirror button  to the left or right.

Adjust the respective mirror by the fourway control.



Select the relevant exterior mirror by turning the control to left  or right  mirror symbol .

Adjust respective mirror by tilting the fourway control.

### Folding mirrors



For pedestrian safety, the exterior mirrors will swing out of their normal mounting position if they are struck with sufficient force. Reposition the mirror by applying slight pressure to the mirror housing.

### Electric folding



Pull the mirror button  rearwards. Both exterior mirrors will fold.

Pull the mirror button rearwards again to return both exterior mirrors to their original position.



If an electrically folded mirror is manually extended, pulling mirror button rearwards will only electrically extend the other mirror.

### Automatic folding

When the vehicle is unlocked, the mirrors swing to their normal mounting position. When the vehicle is locked, the mirrors are folded down.

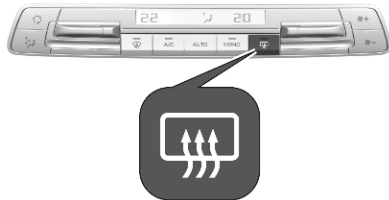
### Heated mirrors



Depending on the version, heating is operated by pressing  or .

Heating works with the engine running and is switched off automatically after a short time.

Heated rear window  42.

### Interior mirrors

#### Manual anti-dazzle



To reduce dazzle, adjust the lever on the underside of the mirror housing.



## Automatic anti-dazzle



Dazzle from following vehicles is automatically reduced, when driving in the dark.

## Child surveillance mirror



A child surveillance mirror allows to observe the rear seats. The mirror can be adjusted.

## Rear view display



The rear view display can show three different views:

- close rear view
- passenger side view
- standard rear view

The standard rear view is displayed by default.

Rear view camera ↻ 196

Passenger side camera ↻ 192

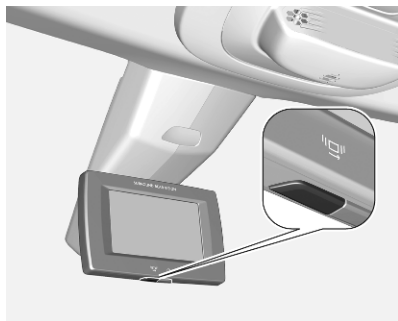

To switch between the views, press .

To switch the rear view display on or off, press .

## Windows

### Windscreen

#### Windscreen stickers



Do not attach stickers such as toll road stickers or similar on the windscreen in the area of the interior mirror. Keep the sensor free from dust, dirt and ice. Otherwise the detection zone of the rain sensor / light sensor and the view area of the camera in the mirror housing could be restricted.

Sensors ⇨ 90, ⇨ 122

### Windscreen replacement

#### Caution

If the vehicle has a front-looking camera sensor for the driver assistance systems, it is very important that any windscreen replacement is performed accurately according to Vauxhall specifications. Otherwise, these systems may not work properly and there is a risk of unexpected behaviour and / or messages from these systems.

### Power windows

#### Warning

Take care when operating the power windows. Risk of injury, particularly to children.

If there are children on the rear seats, switch on the child safety system for the power windows.

Keep a close watch on the windows when closing them. Ensure that nothing becomes trapped in them as they move.

Switch on ignition to operate power windows.



Operate the switch for the respective window by pushing to open or pulling to close.

Pushing or pulling gently to the first detent: window moves up or down as long as the switch is operated.

Pushing or pulling firmly to the second detent then releasing: window moves up or down automatically with safety

function enabled. To stop movement, operate the switch once more in the same direction.

### Safety function



This function depends upon version. If the window glass encounters resistance above the middle of the window during automatic closing, it is immediately stopped and opened again.

### Override safety function

In the event of closing difficulties due to frost or the like, switch on the ignition, then pull the switch to the first detent and hold. The window moves up without safety function enabled. To stop movement, release the switch.

### Child safety system for rear windows





Press  to deactivate rear door power windows; the LED illuminates. To activate, press  again.

### Operating windows from outside

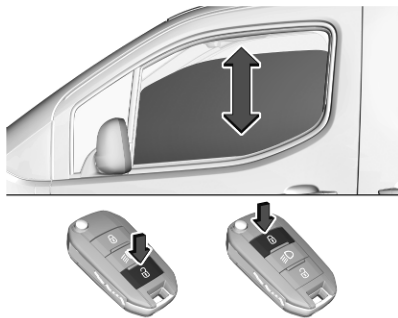
The windows can be operated remotely from outside the vehicle.



Press and hold  to open windows.  
 Press and hold  to close windows.  
 Release button to stop window movement.

### Overload

If the windows are repeatedly operated within short intervals, the window operation is disabled for some time.

### Initialising the power windows

If the windows cannot be closed automatically (e.g. after disconnecting the vehicle battery), a warning message is displayed in the Driver Information Centre.

Vehicle messages ⇨ 114.

Activate the window electronics as follows:

1. Close doors.
2. Switch on ignition.
3. Pull switch until the window is closed and keep pulling for additional two seconds.
4. Push switch until the window is completely open and keep pushing for additional two seconds.
5. Repeat for each window.

### Rear windows

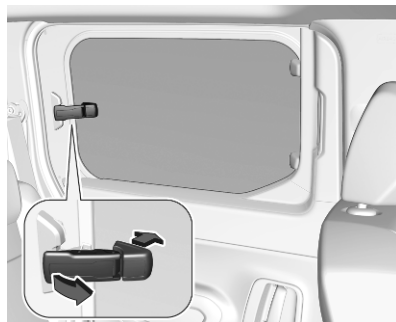

To partially open the rear windows, tilt the lever and push it fully to lock the windows in the open position.

### Heated rear window

Operated by pressing  together with heated exterior mirrors.

Heating works with the engine running and is switched off automatically after a short time.

Depending on climate control system,  is located at a different position.

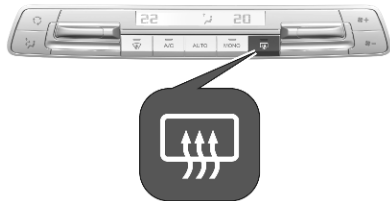

## Sun visors

The sun visors can be folded down or swivelled to the side to prevent dazzling.

If the sun visors have integral mirrors, the mirror covers should be closed when driving.

A ticket holder is located on the backside of the sun visor.

## Roller blinds

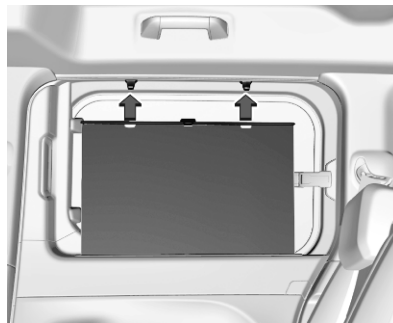

To reduce sunlight at the second row seats, pull the blind upwards using the grip and engage it at the top of the door frame.

## Roof

### Glass panel

### Sunblind



Press  at the rear: the sunblind is opened as long as the switch is operated.

Press  at the front: the sunblind is closed as long as the switch is operated.

## Seats, restraints

<b>Head restraints</b> .....	<b>44</b>
<b>Front seats</b> .....	<b>45</b>
Seat position .....	45
Seat adjustment .....	46
Seat folding .....	47
Armrest .....	49
Heating .....	49
<b>Rear seats</b> .....	<b>50</b>
Second row seats .....	50
Third row seats .....	51
<b>Seat belts</b> .....	<b>54</b>
Three-point seat belt .....	55
<b>Airbag system</b> .....	<b>57</b>
Front airbag system .....	60
Side airbag system .....	60
Curtain airbag system .....	61
Airbag deactivation .....	62
<b>Child restraints</b> .....	<b>63</b>
Child restraint systems .....	63
Child restraint installation locations .....	66

## Head restraints

### Position

#### ⚠ Warning

Only drive with the head restraint set to the proper position.

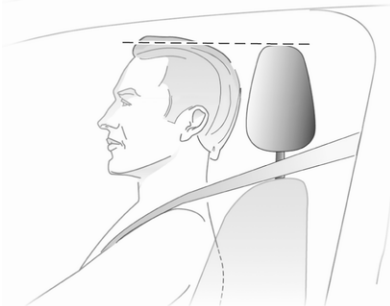

The upper edge of the head restraint should be at upper head level. If this is not possible for extremely tall people, set to highest position, and set to lowest position for small people.

## Adjustment

### Head restraints on front seats

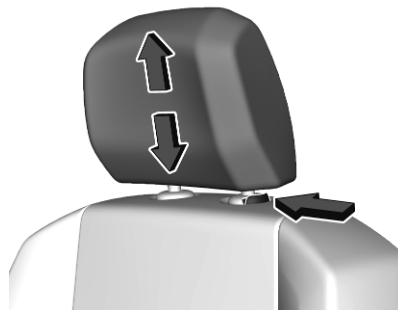

### Height adjustment

Pull the head restraint upwards or press catch and push it downwards.

### Removal

Press catch, pull the respective head restraint upwards and remove.

## Head restraints on rear seats

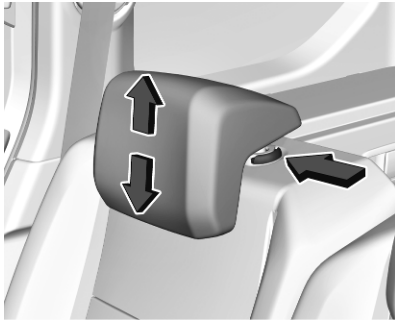

### Height adjustment

Pull the head restraint upwards or push it downwards.

### Removal

Press catch, pull the respective head restraint upwards and remove.

## Front seats

### Seat position

#### ⚠ Warning

Only drive with the seat correctly adjusted.

#### ⚠ Warning

Never adjust seats while driving as they could move uncontrollably.

#### ⚠ Danger

Do not sit closer than 25 cm to the steering wheel, to permit safe airbag deployment.

#### ⚠ Warning

Never store any objects under the seats.



- Sit with buttocks as far back against the backrest as possible. Adjust the distance between the seat and the pedals so that legs are slightly angled when pressing the pedals. Slide the front passenger seat as far back as possible.
- Set seat height high enough to have a clear field of vision on all sides and of all display instruments. There should be at least one hand of clearance between head and the roof frame. Your thighs should rest lightly on the seat without pressing into it.

- Sit with shoulders as far back against the backrest as possible. Set the backrest rake so that it is possible to easily reach the steering wheel with arms slightly bent. Maintain contact between shoulders and the backrest when turning the steering wheel. Do not angle the backrest too far back. We recommend a maximum rake of approx. 25°.
- Adjust seat and steering wheel in a way that the wrist rests on top of the steering wheel while the arm is fully extended and shoulders are on the backrest.
- Adjust the steering wheel ↻ 89.
- Adjust the head restraint ↻ 44.
- Adjust the lumbar support so that it supports the natural shape of the spine.

## Seat adjustment

Drive only with engaged seats and backrests.

### Longitudinal adjustment



Pull the handle, slide the seat, then release the handle. Try to move the seat back and forth to ensure that the seat is locked in place.



Depending on version, pull the lever of the passenger seat and slide the seat, then release the handle.

### Backrest inclination





Push the lever, adjust inclination and release the lever. Do not lean on backrest when adjusting.

### Seat height

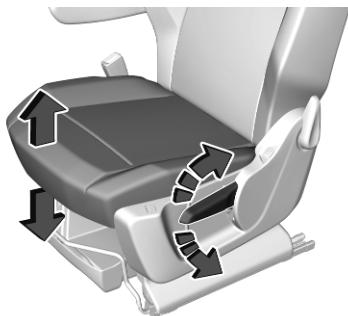

Lever pumping motion

up : seat higher

down : seat lower

### Lumbar support



Turn the handwheel to suit personal requirements.

### Seat folding

Depending on version, the front passenger seat can be folded flat to the table position.

#### Folding single seat front passenger side

Slide the front passenger seat as far back as possible, to avoid contact with the instrument panel during folding.

Push the head restraint down or remove it before folding backrest ⇨ 44.

Depending on version, remove the armrest ⇨ 49.



Push lever, fold backrest fully forwards and release the lever. Then push the backrest down further until it is completely flat.

#### Unfolding single seat front passenger side

To restore the seat to the upright position, pull up the backrest as far as it will go.

Pull the lever and raise backrest fully then release the lever.

### Folding bench seat front passenger side



Fold down the centre backrest by pulling the loop.



Fold down the outer backrest by pulling the loop. Swing the backrest forwards until the seat is lowered on the vehicle floor.

When retracted, the maximum weight on the backrest is 50 kg.



To lift the seat cushion pull the lever and raise the seat cushion against the backrest until it locks.

Storage cargo management system  
↻ 78.

Storage load compartment grille  
↻ 81.

### Unfolding bench seat front passenger side

To restore the backrest to the upright position, pull up the seat till it is engaged.

To restore the seat cushion to the original position, push the lever and lower the seat cushion till it is engaged.

### **⚠ Warning**

When the front passenger seat is in the folded position, the front passenger airbag system must be deactivated.

Airbag deactivation ⇨ 62.

### **Armrest**



The armrest can be folded up.



To remove the armrest fold it up, push and turn it to the position shown in the picture.

Then pull off the armrest from the backrest.

To fit the armrest engage it in the backrest. Push and fold the armrest in the upright position. Pull the armrest out a bit and fold it downwards.

### **Heating**



Activate seat heating by pressing  for the respective front seat.

The LED in the button illuminates to indicate activation.

Pressing  once more deactivates seat heating.

Seat heating is operational when engine is running and during an Autostop.

Stop-start system ⇨ 147.

## Rear seats

### Second row seats

Depending on the equipment, the rear seat backrest is divided into two or three parts. All parts can be folded down.

Before folding rear seat backrests, execute the following if necessary:

- Move front seats forward.
- Remove the load compartment cover ⇨ 75.

### Folding the seats

1. Push the head restraint downwards ⇨ 44.
2. Check that the outer seat belts are lying correctly on the backrests.



3. Pull the release lever on one or both outer sides and fold down the backrests onto the seat cushion.



4. Depending on version, fold down the centre backrest by pulling the loop.



5. Alternatively fold seat backrests from the load compartment: pull lever on left or right sidewall of the load compartment to fold the rear seat backrests.

### **⚠ Warning**

Take care when operating the rear backrests from the load compartment. The backrest is

folded with considerable power.  
Risk of injury, particularly to children.

Ensure that nothing is attached to the rear seats or located on the seat cushion.

### ⚠ Warning

Always make sure that the load in the vehicle is securely stowed. Otherwise objects can be thrown around inside the vehicle and cause personal injury or damage to the load or vehicle.

### Unfolding the seats

To fold up, raise the backrests and guide them into an upright position until they engage audibly.

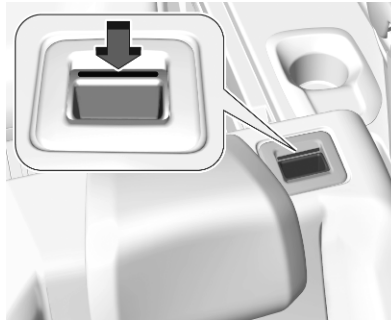

The backrests are properly engaged when the red mark near the release lever is no longer visible.

### ⚠ Warning

When folding up, ensure that backrests are securely locked in position before driving. Failure to do so may result in personal injury or damage to the load or vehicle in the event of hard braking or a collision.

### Third row seats

#### ⚠ Warning

When rear seats or backrests are being adjusted or folded, keep hands and feet away from the moving area.

Never adjust seats while driving as they could move uncontrollably.

Drive only with engaged seats and backrests.

#### ⚠ Warning

When installing the rear seats, ensure that the seat assembly is properly located on the anchor points, the locks are fully engaged, and the backrest is returned to the correct position.

Failure to do so may result in personal injury in the event of hard braking or a collision.

### ⚠ Warning

Always make sure that the load in the vehicle is securely stowed. Otherwise objects can be thrown around inside the vehicle and cause personal injury or damage to the load or vehicle.

Depending on version, the load compartment area can be increased by folding up or removing the third row seats.

### Folding the seats

1. Push the head restraint downwards and if necessary fold down the seats of the second row.  
Head restraints ⇨ 44  
Folding the seats of the second row ⇨ 50



2. Pull the lever and fold down the backrest onto the seat cushion.

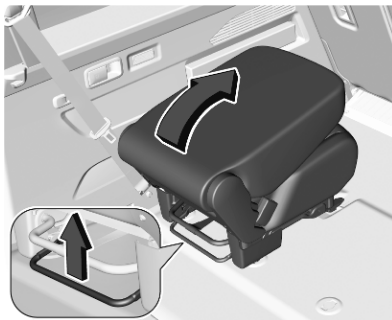

3. Pull the handle and tilt the entire seat forwards.

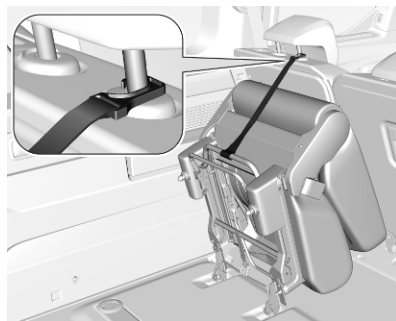

4. Secure the folded seat in the upright position by attaching the strap to one of the pillars of the head restraint in front of the folded seat.

### Unfolding the seats

1. Ensure that the seat belts do not obstruct the unfolding manoeuvre.
2. Remove the strap and lower the seat assembly to the floor, ensuring the rear support is located on the anchor point and securely latched into position.
3. Raise the backrest and adjust the head restraint.

## Removing the seats

1. Push the head restraint downwards and if necessary fold down the seats of the second row.  
Head restraints ⇨ 44  
Folding the seats of the second row ⇨ 50
2. Pull the lever and fold down the backrest onto the seat cushion.  
Pull the handle and tilt the entire seat forwards (refer to "Folding the seats" above).

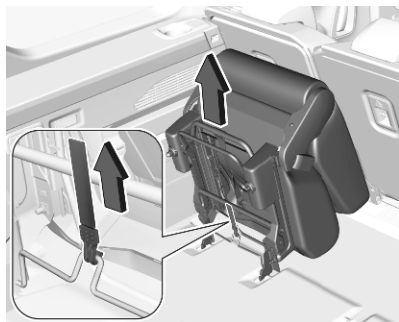

3. Pull the loop to disengage the locks and remove the seat assembly from the floor anchor points.

## Installing the seats

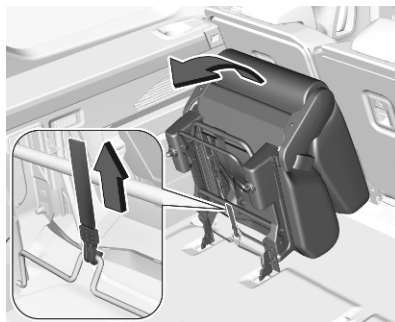

1. Attach the seat assembly front supports to the front anchor points.
2. Fold the seat backwards to the floor to fix its rear anchor point.
3. Raise the backrest and adjust the head restraint.

## Longitudinal seat adjustment



Pull the handle, slide the seat, then release the handle. Try to move the seat back and forth to ensure that the seat is locked in place.

## Seat belts



The seat belts are locked during heavy acceleration or deceleration of the vehicle, holding the occupants in the seat position. Therefore the risk of injury is considerably reduced.

### ⚠ Warning

Fasten seat belt before each trip.

In the event of an accident, people not wearing seat belts endanger their fellow occupants and themselves.

Seat belts are designed to be used by only one person at a time.

Child restraint system ⇨ 63.

Periodically check all parts of the seat belt system for damage, soiling and proper functionality.

Have damaged components replaced. After an accident, have the seat belts and triggered seat belt pretensioners replaced by a workshop.

### Notice

Make sure that the seat belts are neither damaged by shoes or sharp-edged objects nor trapped. Prevent dirt from getting into the seat belt retractors.

### Notice

Use the belt buckle intended for the respective seat belt when fastening in order to ensure proper functionality.

### Seat belt reminder

Each seat is equipped with a seat belt reminder, indicated by a control indicator  for the respective seat in the roof console ⇨ 101.

### Seat belt force limiters

Stress on the body is reduced by the gradual release of the seat belt during a collision.

### Seat belt pretensioners

In the event of a head-on, rear-end or side-on collision of a certain severity, the front seat belts and the outer second row seat belts are tightened by seat belt pretensioners.

### ⚠ Warning

Incorrect handling (e.g. removal or fitting of seat belts) can trigger the seat belt pretensioners.

Deployment of the seat belt pretensioners is indicated by continuous illumination of control indicator  ⇨ 101.

Triggered seat belt pretensioners must be replaced by a workshop. Seat belt pretensioners can only be triggered once.



**Notice**

Do not affix or install accessories or other objects that may interfere with the operation of the seat belt pretensioners. Do not make any modifications to seat belt pretensioner components as this will invalidate the vehicle operating permit.

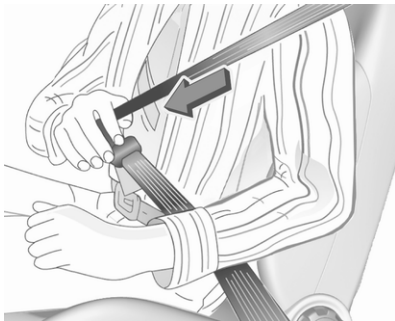
**Three-point seat belt****Fasten**

Withdraw the belt from the retractor, guide it untwisted across the body and insert the latch plate into the buckle. Make sure the belt fits tightly to the body while driving.

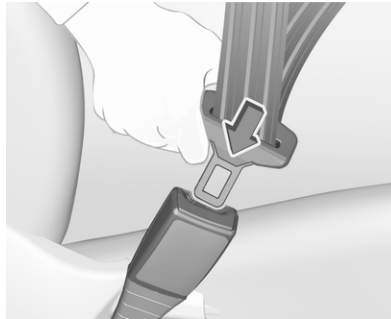

Loose or bulky clothing prevents the belt from fitting snugly. Do not place objects such as handbags or mobile phones between the seat belt and your body.

**⚠ Warning**

The seat belt must not rest against hard or fragile objects in the pockets of your clothing.

Seat belt reminder   101,  108.

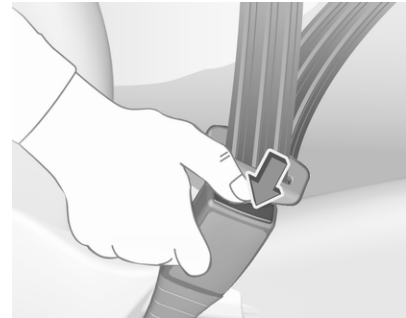
**Unfasten**

To release seat belt, press red button on belt buckle.

**Centre seat belt of the second seat row**

The centre seat is equipped with a particular three-point seat belt.



Pull latch plates with the seat belt out of seat belt holder in the roof.



Insert lower latch plate into left-hand buckle (1) at the centre seat. Guide the upper latch plate with the seat belt over the lap area and the shoulder (do not twist) and insert it into right-hand buckle (2) at centre seat.

To unfasten the seat belt, first press the button on the right-hand buckle (2) and remove upper latch plate. Then press the button on the left-hand buckle (1) and remove lower latch plate. The seat belt retracts automatically.

### Using seat belts while pregnant



### Warning

The lap belt must be positioned as low as possible across the pelvis to prevent pressure on the abdomen.

## Airbag system

The airbag system consists of a number of individual systems depending on the scope of equipment.

When triggered the airbags inflate within milliseconds. They also deflate so quickly that it is often unnoticeable during the collision.

### ⚠ Warning

The airbag system deploys in an explosive manner, repairs must be performed by skilled personnel only.

### ⚠ Warning

Adding accessories that change the vehicle's frame, bumper system, height, front end or side sheet metal, may keep the airbag system from working properly. The operation of the airbag system can also be affected by changing any parts of the front seats, seat belts,

airbag sensing and diagnostic module, steering wheel, instrument panel, inner door seals including the speakers, any of the airbag modules, ceiling or pillar trim, front sensors, side impact sensors or airbag wiring.

### Notice

The airbag systems and belt pretensioner control electronics are located in the centre console. Do not put any magnetic objects in this area.

Do not affix any objects onto the airbag covers and do not cover them with other materials. Have damaged covers replaced by a workshop.

Each airbag is triggered only once. Have deployed airbags replaced by a workshop. Furthermore, it may be necessary to have the steering wheel, the instrument panel, parts of the panelling, the door seals, handles and the seats replaced.

Do not make any modifications to the airbag system as this will invalidate the vehicle operating permit.

Control indicator  for airbag systems  
 ⇨ 101.

## Child restraint systems on front passenger seat with airbag systems

Warning according to ECE R94.02:



**EN:** NEVER use a rearward-facing child restraint on a seat protected by an ACTIVE AIRBAG in front of it; DEATH or SERIOUS INJURY to the CHILD can occur.

**DE:** Nach hinten gerichtete Kindersitze NIEMALS auf einem Sitz verwenden, der durch einen davor befindlichen AKTIVEN AIRBAG

geschützt ist, da dies den TOD oder SCHWERE VERLETZUNGEN DES KINDES zur Folge haben kann.

**FR:** NE JAMAIS utiliser un siège d'enfant orienté vers l'arrière sur un siège protégé par un COUSSIN GONFLABLE ACTIF placé devant lui, sous peine d'infliger des BLESSURES GRAVES, voire MORTELLES à l'ENFANT.

**ES:** NUNCA utilice un sistema de retención infantil orientado hacia atrás en un asiento protegido por un AIRBAG FRONTAL ACTIVO. Peligro de MUERTE o LESIONES GRAVES para el NIÑO.

**RU:** ЗАПРЕЩАЕТСЯ устанавливать детское удерживающее устройство лицом назад на сиденье автомобиля, оборудованном фронтальной подушкой безопасности, если ПОДУШКА НЕ ОТКЛЮЧЕНА! Это может привести к СМЕРТИ или СЕРЬЕЗНЫМ ТРАВМАМ РЕБЕНКА.

**NL:** Gebruik NOOIT een achterwaarts gericht kinderzitje op een stoel met een ACTIEVE AIRBAG ervoor, om DODELIJK of ERNSTIG LETSEL van het KIND te voorkomen.

**DA:** Brug ALDRIG en bagudvendt autostol på et forsæde med AKTIV AIRBAG, BARNET kan komme i LIVSFARE eller komme ALVORLIGT TIL SKADE.

**SV:** Använd ALDRIG en bakåtvänd barnstol på ett säte som skyddas med en framförvarande AKTIV AIRBAG. DÖDSFALL eller ALLVARLIGA SKADOR kan drabba BARNET.

**FI:** ÄLÄ KOSKAAN sijoita taaksepäin suunnattua lasten turvaistuinta istuimelle, jonka edessä on AKTIIVINEN TURVATYYNY, LAPSI VOI KUOLLA tai VAMMAUTUA VAKAVASTI.

**NO:** Bakovervendt barnesikringsutstyr må ALDRI brukes på et sete med AKTIV KOLLISJONSPUTE foran, da det kan føre til at BARNET utsettes for LIVSFARE og fare for ALVORLIGE SKADER.

**PT:** NUNCA use um sistema de retenção para crianças voltado para trás num banco protegido com um AIRBAG ACTIVO na frente do mesmo, poderá ocorrer a PERDA DE VIDA ou FERIMENTOS GRAVES na CRIANÇA.

**IT:** Non usare mai un sistema di sicurezza per bambini rivolto all'indietro su un sedile protetto da AIRBAG ATTIVO di fronte ad esso: pericolo di MORTE o LESIONI GRAVI per il BAMBINO!

**EL:** ΠΟΤΕ μη χρησιμοποιείτε παιδικό κάθισμα ασφαλείας με φορά προς τα πίσω σε κάθισμα που προστατεύεται από μετωπικό ΕΝΕΡΓΟ ΑΕΡΟΣΑΚΟ, διότι το παιδί μπορεί να υποστεί ΘΑΝΑΣΙΜΟ ή ΣΟΒΑΡΟ ΤΡΑΥΜΑΤΙΣΜΟ.

**PL:** NIE WOLNO montować fotelika dziecięcego zwróconego tyłem do kierunku jazdy na fotelu, przed którym znajduje się WŁĄCZONA PODUSZKA POWIETRZNA. Niezastosowanie się do tego zalecenia może być przyczyną ŚMIERCI lub POWAŻNYCH OBRAŻEŃ u DZIECKA.

**TR:** Arkaya bakan bir çocuk emniyet sistemini KESİNLİKLE önünde bir AKTİF HAVA YASTIĞI ile korunmakta olan bir koltukta kullanmayınız. ÇOCUK ÖLEBİLİR veya AĞIR ŞEKİLDE YARALANABİLİR.

**UK:** НИКОЛИ не використовуйте систему безпеки для дітей, що встановлюється обличчям назад, на сидінні з УВІМКНЕНОЮ ПОДУШКОЮ БЕЗПЕКИ, інакше це може призвести до СМЕРТІ чи СЕРІОЗНОГО ТРАВМУВАННЯ ДИТИНИ.

**HU:** SOHA ne használjon hátrafelé néző biztonsági gyerekülést előlről AKTÍV LÉGZSÁKKAL védett ülésen, mert a GYERMEK HALÁLÁT vagy KOMOLY SÉRÜLÉSÉT okozhatja.

**HR:** NIKADA nemojte koristiti sustav zadržavanja za djecu okrenut prema natrag na sjedalu s AKTIVNIM ZRAČNIM JASTUKOM ispred njega, to bi moglo dovesti do SMRTI ili OZBILJNIH OZLJEDA za DIJETE.

**SL:** NIKOLI ne nameščajte otroškega varnostnega sedeža, obrnjenega v nasprotni smeri vožnje, na sedež z

AKTIVNO ČELNO ZRAČNO BLAZINO, saj pri tem obstaja nevarnost RESNIH ali SMRTNIH POŠKODB za OTROKA.

**SR:** NIKADA ne koristiti bezbednosni sistem za decu u kome su deca okrenuta unazad na sedištu sa AKTIVNIM VAZDUŠNIM JASTUKOM ispred sedišta zato što DETE može da NASTRADA ili da se TEŠKO POVREDI.

**MK:** НИКОГАШ не користете детско седиште свртено наназад на седиште заштитено со АКТИВНО ВОЗДУШНО ПЕРНИЧЕ пред него, затоа што детето може ДА ЗАГИНЕ или да биде ТЕШКО ПОВРЕДЕНО.

**BG:** НИКОГА не използвайте детска седалка, гледаща назад, върху седалка, която е защитена чрез АКТИВНА ВЪЗДУШНА ВЪЗГЛАВНИЦА пред нея - може да се стигне до СМЪРТ или СЕРИОЗНО НАРАНЯВАНЕ на ДЕТЕТО.

**RO:** Nu utilizați NICIODATĂ un scaun pentru copil îndreptat spre partea din spate a mașinii pe un scaun protejat de un AIRBAG ACTIV în fața sa;

acest lucru poate duce la DECESUL sau VĂTĂMAREA GRAVĂ a COPILULUI.

**CS:** NIKDY nepoužívejte dětský zádržný systém instalovaný proti směru jízdy na sedadle, které je chráněno před sedadlem AKTIVNÍM AIRBAGEM. Mohlo by dojít k VÁŽNĚMU PORANĚNÍ nebo ÚMRTÍ DÍTĚTE.

**SK:** NIKDY nepoužívajte detskú sedačku otočenú vzad na sedadle chránenom AKTÍVNÝM AIRBAGOM, pretože môže dôjsť k SMRTI alebo VÁŽNYM ZRANENIAM DIEŤAŤA.

**LT:** JOKIU BŪDU nemontuokite atgal atgręžtos vaiko tvirtinimo sistemas sėdynėje, prieš kurią įrengta AKTYVI ORO PAGALVĖ, nes VAIKAS GALI ŽŪTI arba RIMTAI SUSIŽALOTI.

**LV:** NEKĀDĀ GADĪJUMĀ neizmantojiet uz aizmuguri vērstu bērnu sēdekļīti sēdvietā, kas tiek aizsargāta ar tās priekšā uzstādītu AKTĪVU DROŠĪBAS SPILVENU, jo pretējā gadījumā BĒRNS var gūt SMAGAS TRAUMAS vai IET BOJĀ.

**ET:** ÄRGE kasutage tahapoole suunatud lapseturvaistet istmel, mille ees on AKTIIVSE TURVAPADJAGA kaitstud iste, sest see võib põhjustada LAPSE SURMA või TÕSISE VIGASTUSE.

**MT:** QATT tuża trażżin għat-*tfal* li jħares lejn in-naħa ta' wara fuq sit protett b'AIRBAG ATTIV quddiemu; dan jista' jikkawża I-MEWT jew ĠRIEHI SERJI lit-TFAL.

**GA:** Ná húsáid srian sábháilteachta linbh cúil RIAMH ar shuíochán a bhfuil mála aeir ag feidhmiú os a chomhair. Tá baol BÁIS nó GORTÚ DONA don PHÁISTE ag baint leis.

Beyond the warning required by ECE R94.02, for safety reasons a forward-facing child restraint system must only be used subject to the instructions and restrictions in the table ⇨ 66.

The airbag label is located on both sides of the front passenger sun visor. Airbag deactivation ⇨ 62.

## Front airbag system

The front airbag system consists of one airbag in the steering wheel and one in the roof on the front passenger side. These can be identified by the word **AIRBAG**.

The front airbag system is triggered in the event of a front-end impact of a certain severity. The ignition must be switched on.

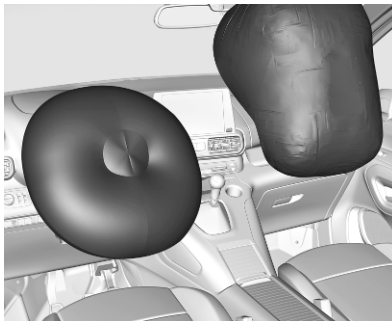

The inflated airbags cushion the impact, thereby reducing the risk of injury to the upper body and head of the front seat occupants considerably.

## ⚠ Warning

Optimum protection is only provided when the seat is in the proper position.

Seat position ⇨ 45.

Keep the area in which the airbag inflates clear of obstructions.

Fit the seat belt correctly and engage securely. Only then is the airbag able to protect.

## Side airbag system

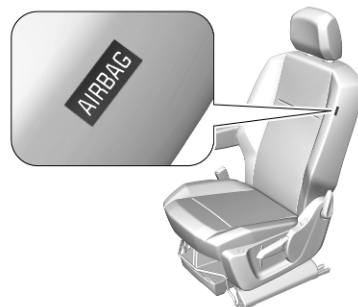

The side airbag system consists of an airbag in each front seat backrest. This can be identified by the word **AIRBAG**.

The side airbag system is triggered in the event of a side impact of a certain severity. The ignition must be switched on.



The inflated airbags cushion the impact, thereby reducing the risk of injury to the upper body and pelvis in the event of a side-on collision considerably.

### ⚠ Warning

Keep the area in which the airbag inflates clear of obstructions.

### Notice

Only use protective seat covers that have been approved for the vehicle. Be careful not to cover the airbags.

## Curtain airbag system

The curtain airbag system consists of an airbag in the roof frame on each side. This can be identified by the word **AIRBAG** on the roof pillars.

The curtain airbag system is triggered in the event of a side-on impact of a certain severity. The ignition must be switched on.

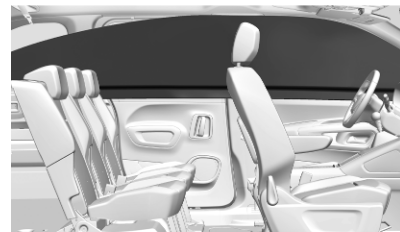

The inflated airbags cushion the impact, thereby reducing the risk of injury to the head in the event of a side-on impact considerably.

### ⚠ Warning

Keep the area in which the airbag inflates clear of obstructions.

The hooks on the handles in the roof frame are only suitable for hanging up light articles of clothing, without coat hangers. Do not keep any items in these clothes.



## Airbag deactivation

The front passenger airbag system must be deactivated for child restraint system on the passenger seat according to the instructions in the table ⇨ 66. The side airbag and curtain airbag systems, the belt pretensioners and all driver airbag systems will remain active.



The front passenger airbag system can be deactivated via a key-operated switch on the passenger side of the instrument panel.

Use the ignition key to choose the position:

- OFF  : front passenger airbag is deactivated and will not inflate in the event of a collision, control indicator OFF  illuminates continuously in the centre console
- ON  : front passenger airbag is active

### Danger

Deactivate passenger airbag only in combination with the use of a child restraint system, subject to the instructions and restrictions in the table ⇨ 66.

Otherwise, there is a risk of fatal injury for a person occupying a seat with a deactivated front passenger airbag.



If the control indicator  illuminates for approx. 60 seconds after the ignition is switched on, the front passenger airbag system will inflate in the event of a collision.

If the control indicator  illuminates after the ignition is switched on, the front passenger airbag system is deactivated. It stays on while the airbag is deactivated.

If both control indicators are illuminated at the same time, there is a system failure. The status of the system is not discernible, therefore no person is allowed to occupy the front passenger seat. Contact a workshop immediately.



Consult a workshop immediately if neither of the two control indicators are illuminated.

In the event of a fault a warning message is displayed in the Driver Information Centre and warning chime will sound.

Change status only when the vehicle is stopped with the ignition off.

Status remains until the next change.

Control indicator for airbag deactivation ↻ 102.

## Child restraints

### Child restraint systems

#### ⚠ Danger

If using a rear-facing child restraint system on the front passenger seat, the airbag system for the front passenger seat must be deactivated. This also applies to certain forward-facing child restraint systems as indicated in the tables ↻ 66.

Airbag deactivation ↻ 62.

Airbag label ↻ 57.

We recommend a child restraint system which is tailored specifically to the vehicle. For further information, contact your workshop.

When a child restraint system is being used, pay attention to the following usage and installation instructions as well as to those supplied with the child restraint system.

Always comply with local or national regulations. In some countries, the use of child restraint systems is forbidden on certain seats.

Child restraint systems can be fastened with:

- Three-point seat belt
- ISOFIX brackets
- Top-tether

#### Three-point seat belt

Child restraint systems can be fastened by using a three-point seat belt.

#### ISOFIX brackets



Fasten vehicle-approved ISOFIX child restraint systems to the ISOFIX brackets. Specific vehicle ISOFIX child restraint system positions are marked in the ISOFIX table ↷ 66.

The ISOFIX brackets are located below the i-Size symbol in the seat cover.

An i-Size child restraint system is an universal ISOFIX child restraint system according UN Regulation No. 129.

All i-Size child restraint systems can be used on any vehicle seat suitable for i-Size, i-Size table ↷ 66.

Either a Top-tether strap or a support leg must be used in addition to the ISOFIX brackets.

A support leg must be placed firmly on the floor. Positioning the support leg in a footwell storage is not permitted.



i-Size child seats and vehicle seats with i-Size approval are marked with i-Size symbol, see illustration.

### Top-tether anchors

Top-tether anchors are marked with the symbol  for a child seat.



In addition to the ISOFIX brackets, fasten the Top-tether strap to the Top-tether anchors.

Third row seats ↷ 51.

ISOFIX child restraint systems of universal category positions are marked in the table by IUF ↷ 66.

### Selecting the right system

The rear seats are the most convenient location to fasten a child restraint system.

Children should travel facing rearwards in the vehicle as long as possible. This makes sure that the child's backbone, which is still very weak, is under less strain in the event of an accident.

Suitable are child restraint systems that comply with valid UN ECE regulations. Check local laws and regulations for mandatory use of child restraint systems.

The following child restraints are recommended for the following weight classes:

- **Group 0+:**  
Römer Baby-Safe Plus with ISOFIX base for children up to 13 kg
- **Group I:**  
Römer Duo Plus ISOFIX with ISOFIX and Top-tether for children from 9 kg to 18 kg

- **Group II, Group III:**  
Römer Kidfix XP with or without  
ISOFIX for children from 15 kg to  
36 kg
- **Group III:** Graco Booster for  
children from 22 kg to 36 kg

Ensure that the child restraint system to be installed is compatible with the vehicle type.

Ensure that the mounting location of the child restraint system within the vehicle is correct, see following tables.

Allow children to enter and exit the vehicle only on the side facing away from the traffic.

When the child restraint system is not in use, secure the seat with a seat belt or remove it from the vehicle.

#### **Notice**

Do not affix anything on the child restraint systems and do not cover them with any other materials.

A child restraint system which has been subjected to stress in an accident must be replaced.

## Child restraint installation locations

### Permissible options for fastening a child restraint system with a three-point seat belt

Weight class	On front passenger seat		On outer seats in the second row	On centre seat in the second row	On seats in the third row
	activated airbag	deactivated airbag			
<b>Group 0, Group 0+: up to 13 kg</b>	X	U <sup>1,2</sup>	U <sup>3</sup>	U	U <sup>3</sup>
<b>Group I: 9 to 18 kg</b>	UF	U <sup>1,2</sup>	U <sup>3,4</sup>	U	U <sup>3,4</sup>
<b>Group II: 15 to 25 kg</b>	UF	U <sup>1,2</sup>	U <sup>3,4</sup>	U	U <sup>3,4</sup>
<b>Group III: 22 to 36 kg</b>	UF	U <sup>1,2</sup>	U <sup>3,4</sup>	U	U <sup>3,4</sup>

U : universal suitability for forward-facing or rearward-facing child restraint systems in conjunction with three-point seat belt

UF : universal suitability for forward-facing child restraint systems in conjunction with three-point seat belt

X : no child restraint system permitted in this weight class

<sup>1</sup> : move seat forwards as far as necessary and adjust seat backrest inclination as far as necessary to a vertical position to ensure that the belt runs forwards from the upper anchorage point

<sup>2</sup> : adjust seat backrest inclination as far as necessary to a vertical position to ensure that the belt is tight on the buckle side

<sup>3</sup> : move the respective front seat ahead of the child restraint system forwards as far as necessary

<sup>4</sup> : adjust the respective headrest as necessary or remove if required

## Permissible options for fitting an ISOFIX child restraint system with ISOFIX brackets

Weight class	Size class	Fixture	On front passenger seat	On the seats in the second row	On the seats in the third row
Group 0: up to 10 kg	G	ISO/L2	X	X	X
	F	ISO/L1	X	X	X
		ISO/R1	X	IL <sup>3</sup>	X
Group 0+: up to 13 kg	E	ISO/R1	X	IL <sup>3</sup>	X
	D	ISO/R2	X	IL <sup>3</sup>	X
	C	ISO/R3	X	IL <sup>3</sup>	X
Group I: 9 to 18 kg	D	ISO/R2	X	IL <sup>3,4</sup>	X
	C	ISO/R3	X	IL <sup>3,4</sup>	X
	B	ISO/F2	X	IL, IUF <sup>3,4</sup>	X
	B1	ISO/F2X	X	IL, IUF <sup>3,4</sup>	X
	A	ISO/F3	X	IL, IUF <sup>3,4</sup>	X

IL : suitable for particular ISOFIX restraint systems of the 'specific-vehicle', 'restricted' or 'semi-universal' categories.  
The ISOFIX restraint system must be approved for the specific vehicle type (refer to the vehicle type list of the child restraint system)

IUF : suitable for ISOFIX forward-facing child restraint systems of universal category approved for use in this weight class

X : no ISOFIX child restraint system approved in this weight class

<sup>3</sup> : move the respective front seat ahead of the child restraint system forwards as far as necessary

<sup>4</sup> : adjust the respective headrest as necessary or remove if required

**ISOFIX size class and seat device**

- A – ISO/F3 : forward-facing child restraint system for children of maximum size in the weight class 9 to 18 kg  
 B – ISO/F2 : forward-facing child restraint system for smaller children in the weight class 9 to 18 kg  
 B1 – ISO/F2X : forward-facing child restraint system for smaller children in the weight class 9 to 18 kg  
 C – ISO/R3 : rear-facing child restraint system for children of maximum size in the weight class up to 18 kg  
 D – ISO/R2 : rear-facing child restraint system for smaller children in the weight class up to 18 kg  
 E – ISO/R1 : rear-facing child restraint system for young children in the weight class up to 13 kg  
 F – ISO/L1 : left lateral facing position child restraint system (carry-cot)  
 G – ISO/L2 : right lateral facing position child restraint system (carry-cot)

**Permissible options for fitting an i-Size child restraint system with ISOFIX brackets**

	On front passenger seat	On the seats in the second row	On the seats in the third row
<b>i-Size child restraint systems</b>	X	i - U	X

i - U : suitable for i-Size 'universal' forward and rearward facing child restraint systems

X : seating position not suitable for i-Size 'universal' child restraint systems

## Storage

<b>Storage compartments</b> .....	<b>69</b>
Glovebox .....	69
Cupholders .....	69
Front storage .....	70
Overhead console .....	71
Underseat storage .....	72
Centre console storage .....	73
Footwell storage .....	73
<b>Load compartment</b> .....	<b>74</b>
Ladder flap .....	74
Load compartment cover .....	75
Lashing eyes .....	78
Cargo management system .....	78
Safety net .....	79
Load compartment grille .....	81
Warning triangle .....	84
First aid kit .....	84
<b>Roof rack system</b> .....	<b>84</b>
Roof rack .....	84
<b>Loading information</b> .....	<b>85</b>
Overload indicator .....	86

## Storage compartments

### ⚠ Warning

Do not store heavy or sharp objects in the storage compartments. Otherwise vehicle occupants could be injured by objects being thrown around in the event of hard braking, a sudden change in direction or an accident.

## Glovebox

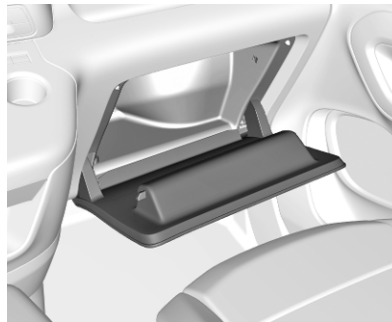

To open the glovebox pull the handle.

The glovebox should be closed whilst driving.

## Cupholders

### Front cupholder

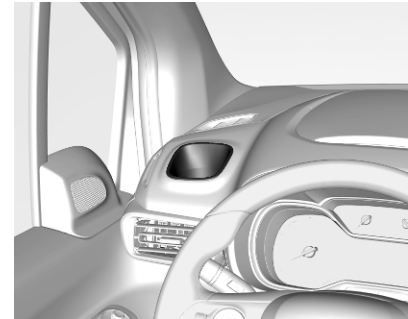

Cup holders are located at the sides of the instrument panel.

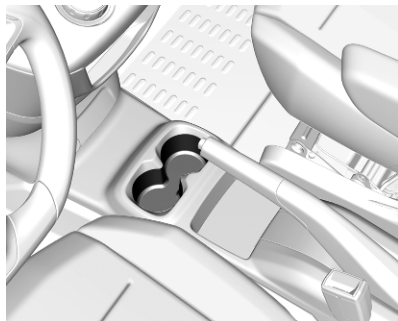

Cupholders may be located in the centre console.

### Rear cupholder



Additional cup holders may be located in the foldaway tables on the backrests of the front seats. Fold up the table.

Do not place any hard or heavy objects on the table.



Cupholders for the third row seats are located in the sides of the load compartment.

### Front storage

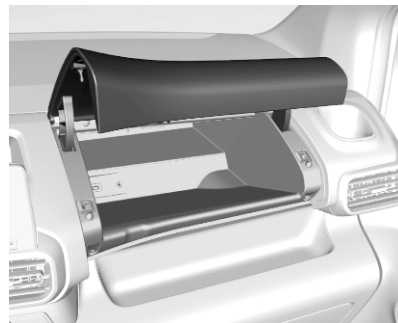

A storage compartment is located on top of the instrument panel.

Some versions have a CD player, a USB, a glovebox cooler and AUX socket in the storage compartment.





A storage compartment is located above the Instrument cluster.

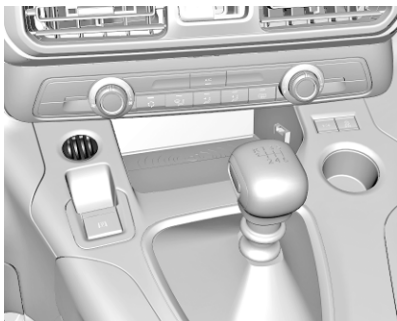

A coin holder is located on the instrument panel.

## Folding the centre seatback



The front centre passenger seat backrest has a document tray.  
Seat folding ⇨ 47.

### **⚠ Warning**

When the front centre passenger seat is in the folded position, the front passenger airbag system must be deactivated.

Airbag deactivation ⇨ 62.

## Overhead console



Store only lightweight items such as paperwork or maps.

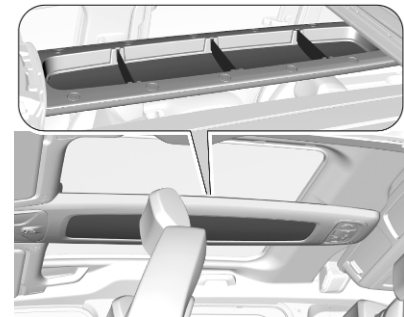

The separation of the four compartments can be taken out.

The maximum permitted load is 6 kg.

### ⚠ Warning

Secure objects to prevent them from falling out and causing injury.

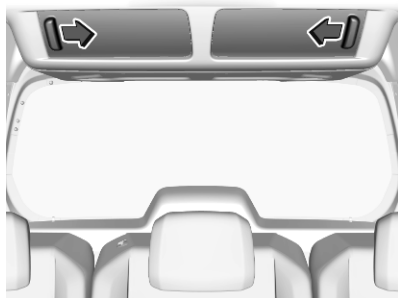

Slide the flaps to open.

Close whilst driving. The maximum permitted load is 10 kg.



Pull handle to open.

Close whilst driving. The maximum permitted load is 10 kg.

## Underseat storage

### Underseat drawer

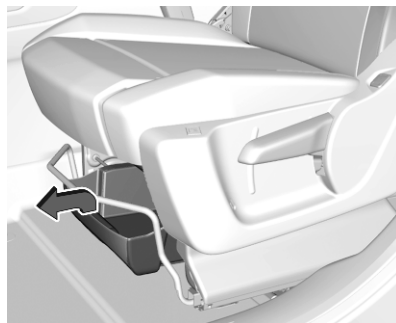

There may be a drawer under the front seats. To open lift the drawer a bit and then pull.

## Storage box

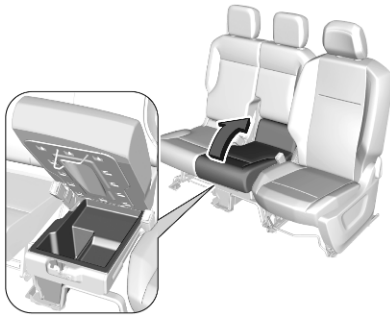

There may be a storage box under the centre bench seat. Lift up the seat cushion by pulling the handle. The storage box can be locked by a padlock.

## Centre console storage

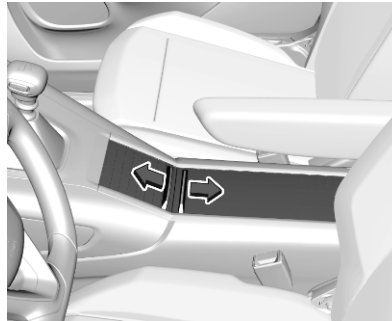

A storage box may be located in the centre console. Press cover to open. A 12 V power outlet is located behind the storage cover.

## Footwell storage

The footwell storages can be accessed from the rear seats.

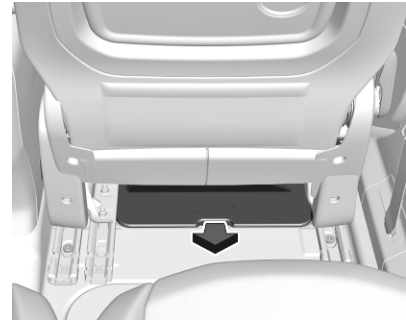

Vehicle tools may be located in the storage compartments underneath the front seats ⇨ 230.

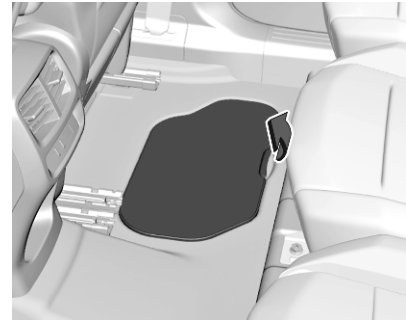

Depending on version, there are two storage compartments in the rear footwell.

## Load compartment

Depending on version, the load compartment area can be increased by folding up or removing the third row seats. The seat backrests of the second row can be folded forward separately. Additionally, the backrest of the passenger seat can be folded.

Depending on the loading, only single seats or backrests can be folded.

Folding passenger seat ⇨ 47

Folding second row seats ⇨ 50

Folding or removing third row seats  
⇨ 50

## Ladder flap

The ladder flap is available for transporting long loads.

## Opening the ladder flap



1. Press the lever and disengage the spring clip from the retainer by pulling.
2. Lift the ladder flap.



3. Move past the point of resistance to lock the ladder flap with the props.

### Support bar

Rest long loads on the support bar.



1. Push the lever to the top.
2. Push the support bar a bit to the front and then guide it down to the door pillar.
3. Hold the long load in the angled position.
4. Move the support bar below the load to its original position. Fix it by pressing the lever downwards past the point of resistance.

The rear doors will only lock when the support bar is installed.

5. Secure the loads firmly. The side supports can be used as hooking points.

### Closing the ladder flap

1. Check that the support bar is properly locked.
2. Lower the ladder flap.
3. Fix the spring clip in its retainer.

### Load compartment cover

#### Rear luggage cover

Do not place any objects on the cover.

#### Closing the cover

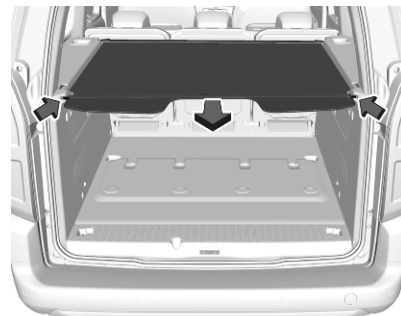

Pull the load compartment cover towards the rear and engage it in the side brackets.

### Opening the cover

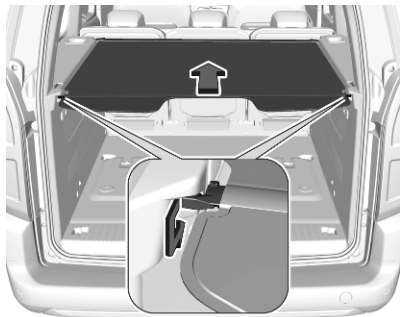

Remove load compartment cover from side brackets. Guide the cover until it is fully rolled up.

### Removing the cover

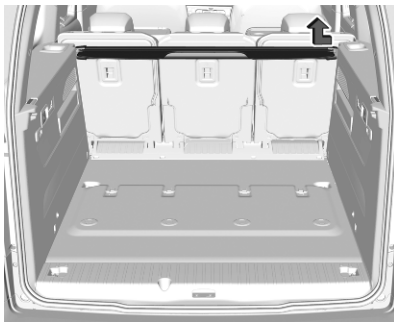

Open the load compartment cover. Compress the load compartment cover at one side and lift it up. Remove the load compartment cover.

### Stowing in the load compartment



If the load compartment cover is not used, stow it in the load compartment. It can be stowed behind the second or third row seats.

### Fitting the cover

Insert the load compartment cover into the recess at one side. Compress the cover at the other side and engage it in the recess.

## Rear parcel shelf

Do not place any excessively heavy or sharp-edged objects on the rear parcel shelf. The maximum load permissible is 25 kg. With high loads install the safety net behind the rear seats ↗ 79.

## Installing the rear parcel shelf



The rear parcel shelf can be installed in two positions.

Fit the parcel shelf by engaging in the retainers on both sides.

## Lifting the rear parcel shelf



The rear parcel shelf may be folded up from the rear, allowing greater flexibility in the load compartment.

## Stowing in the load compartment



Set up the folded cover upright behind the rear seat backrests.

## Lashing eyes

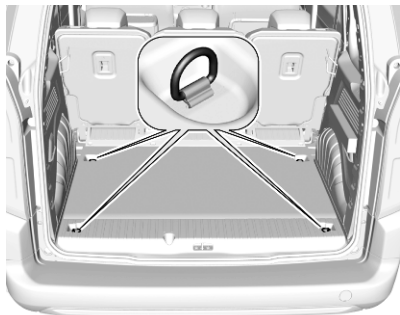

The lashing eyes are designed to secure items against slippage, e.g. using lashing straps or luggage net.



Lashing eyes may be located on the vehicle floor and / or in the sidewall. The number and location of the lashing eyes may vary depending on the vehicle.

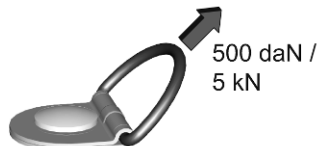

The maximum force applied to the lashing eyes should not exceed 500 daN / 5 kN / 5000 N.

Depending on country, the maximum force may be shown on a label.

### Notice

Specifications on the label always have priority over those given in this manual.

## Cargo management system

Depending on version, a partition behind the front seats protects the driver and front passengers against the risk of load movement.

There may be a flap in the partition behind the passenger seat which can be removed to accommodate long objects. A protective cover is provided in the vehicle to assure safe transportation.

If the outer passenger seat backrest is folded down and the partition flap is open, the centre seat has to stay free.

## Removing the flap

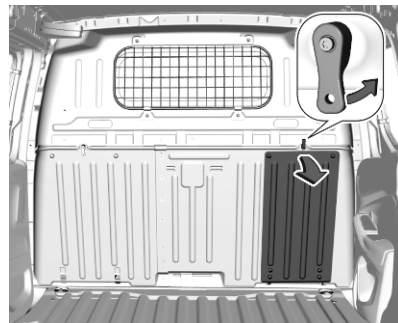

1. Release the locking device, lower the flap and then remove it.
2. Stow the flap behind the driver's seat.



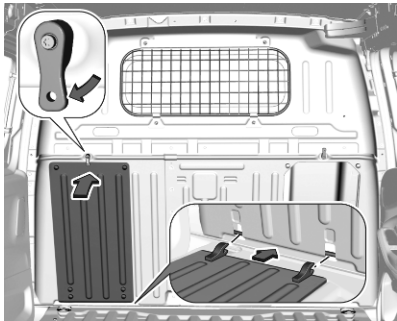

Turn the locking device upwards. Put the hinges of the flap in their housing, lift the flap and close the locking device.

### Fitting the protective cover

The protective cover must be installed whenever the outer passenger seat backrest is folded down and the partition flap is open.

1. Fold the outer passenger seat backrest ↗ 47.

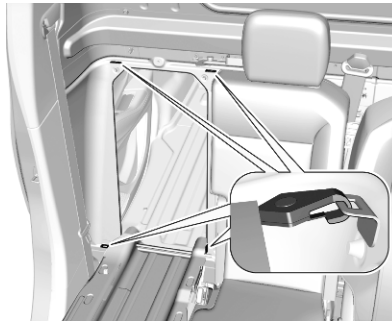

2. Attach the four snap hooks of the cover on the corresponding lashing eye.
3. Pull the head restraint from the folded backrest, leaving two notches visible on the head restraint rod ↗ 44.
4. Load the objects.

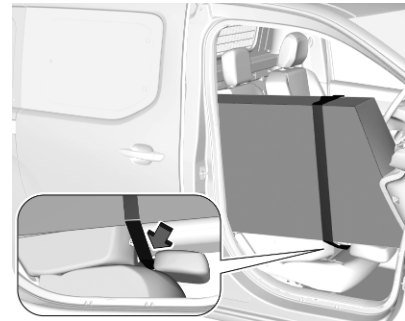

5. Pass the strap of the cover around the head restraint. Tension the strap by pulling at the loose end.

With fitted protective cover the maximum load on the folded backrest is 100 kg.

### Safety net

Depending on version, the safety net can be installed behind the rear seats or, if the rear seat backrests are folded, behind the front seats.

Passengers must not be transported behind the safety net.

## Installation

### Behind the rear seats



- There are installation openings on both sides in the roof frame above the rear seats. Open the covers and suspend and engage rod of net at one side, compress rod and suspend and engage at the other side.



- Attach the hooks of safety net straps in the lashing eyes behind the rear seats.  
Tension both straps by pulling at the loose end.
- Rear seat backrests must be raised up.

### Behind the front seats



- There are installation openings on both sides in the roof frame above the front seats. Open the covers and suspend and engage rod of net at one side, compress rod and suspend and engage at the other side.

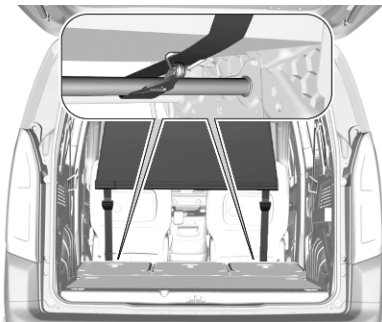

- Wind one strap around the bar located under the front driver seat cushion. The other one wind around the bar of the passenger seat. Then secure each hook to the corresponding strap.

Tension both straps by pulling at the loose end.

- Push down head restraints and fold down rear seat backrests  
⇨ 74.

## Load compartment grille

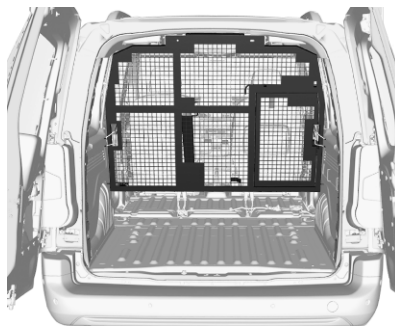

Depending on version a partition protects the driver and passengers against the risk of load movement.

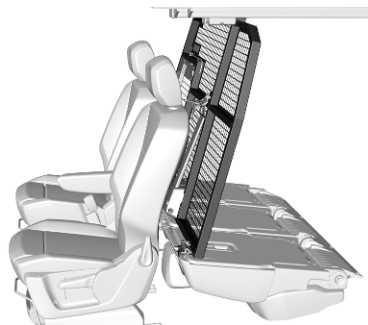

The partition can be placed behind the front or rear seats.



There is a flap in the partition which can be opened to accommodate long objects. A protective cover is provided in the vehicle to assure safe transportation.

If the side seat backrest is folded down and the partition flap is open the centre seat has to stay free.

If the backrest of the rear seat is lowered and the flap open to transport long objects, the front passenger seat has to stay free.

### Moving the partition

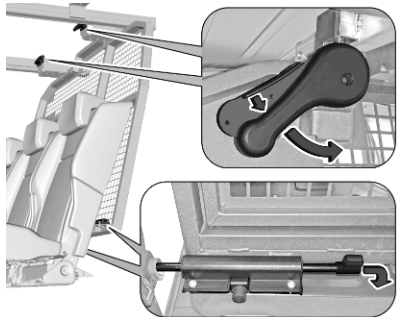

1. Release the four locking devices on the top and the bottom of the partition.
2. To be placed behind the front seats fold down the rear seat backrests ↻ 50

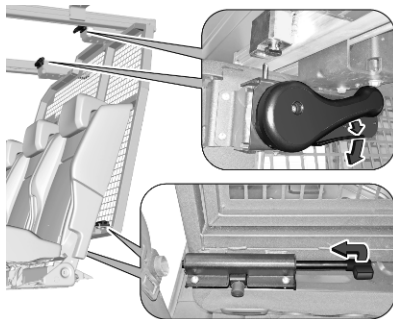

3. Move the partition and lock the four locking devices on the top and the bottom.

#### **⚠ Warning**

Take care when operating the bottom locking devices. Risk of pinching.

### Opening the flap

1. Depending on the positioning of the partition and the length of the load fold down the outer rear seat backrest and / or passenger seat backrest ↻ 47, 50

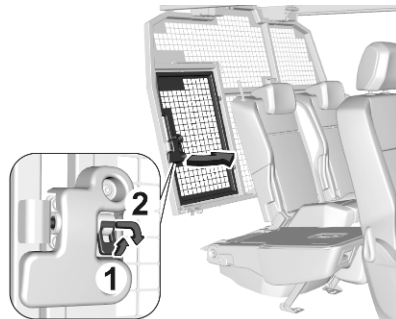

2. Release the locking device of the flap and open the flap.



3. Secure the flap with the rod.

## Closing the flap

1. Fix the rod in the bracket.

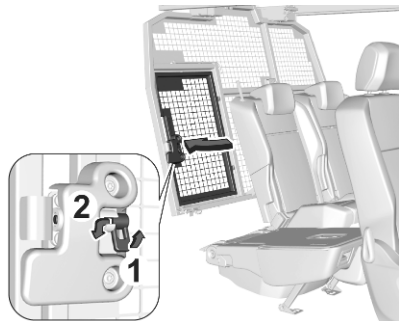

2. Close the flap and lock the locking device.
3. Restore the seats to the upright position ↻ 47, 50

## Fitting the protective cover

The protective cover must be installed whenever the side seat backrest is folded down and the partition flap is open.

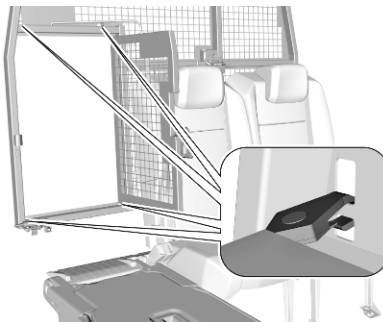

1. Attach the four snap hooks of the cover on the corresponding lashing eye.
2. Pull the head restraint from the folded backrest, leaving two notches visible on the head restraint rod ↻ 44.
3. Load the objects.

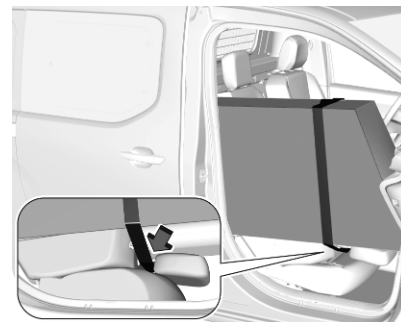

4. Pass the strap of the cover around the head restraint. Tension the strap by pulling at the loose end.

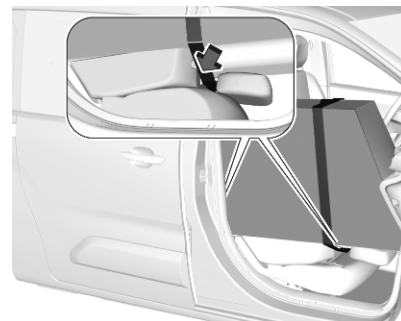

If the loading is stored on the front and rear seat at the passenger

side pass one strap on each head restraint.

With fitted protective cover the maximum load on each of the folded backrests is 100 kg.

## Warning triangle



Depending on version, the warning triangle can be stowed in the load compartment. Secure it with the elastic straps.

## First aid kit

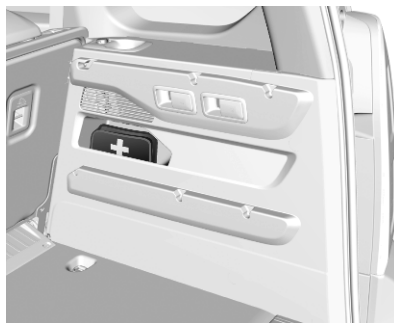

Depending on version, the first aid kit can be stowed in the load compartment.

## Roof rack system

### Roof rack

For safety reasons and to avoid damage to the roof, the vehicle approved roof rack system is recommended. For further information contact your workshop.

Follow the installation instructions and remove the roof rack when not in use.

### Mounting roof rack

#### Vehicles with roof railing



Mounting points are located at the bottom of the roof railing.

Fasten the roof rack according to the installation instructions delivered with the roof rack.

### Vehicles without roof railing

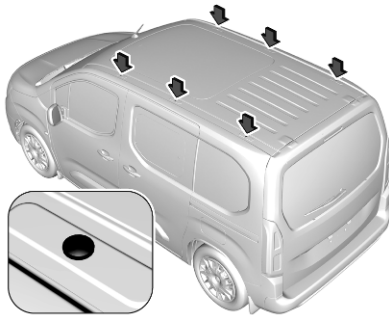

To fasten a roof rack, unscrew the caps in the roof strips. Insert the mounting provisions, as instructed, in the retainer.

## Loading information

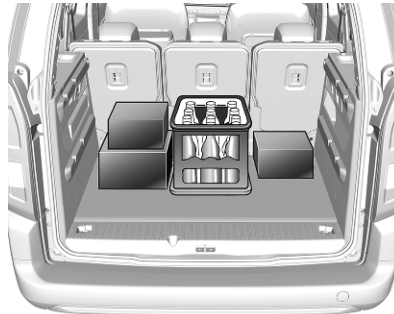

- Heavy objects in the load compartment should be placed against the seat backrests. Make sure that the backrests are securely engaged. If objects can be stacked, heavier objects should be placed at the bottom.
- Prevent sliding of loose objects by securing them with straps attached to the lashing eyes  $\diamond$  78.
- Do not allow the load to protrude above the upper edge of the backrests.

- Do not place any objects on the rear luggage cover or the instrument panel, and do not cover the sensor on top of the instrument panel.
- The load must not obstruct the operation of the pedals, parking brake and gear selector, or hinder the freedom of movement of the driver. Do not place any unsecured objects in the interior.
- Do not drive with an open load compartment.

### **⚠ Warning**

Always make sure that the load in the vehicle is securely stowed. Otherwise objects can be thrown around inside the vehicle and cause personal injury or damage to the load or car.

- The payload is the difference between the permitted gross vehicle weight (see identification plate  $\diamond$  256) and the EC kerb weight.

To calculate the payload, enter the data for your vehicle in the weights table at the front of this manual.

The EC kerb weight includes weights for the driver (68 kg), luggage (7 kg) and all fluids (fuel tank 90% full).

Optional equipment and accessories increase the kerb weight.

- Driving with a roof load increases the sensitivity of the vehicle to cross-winds and has a detrimental effect on vehicle handling due to the vehicle's higher centre of gravity. Distribute the load evenly and secure it properly with retaining straps. Adjust the tyre pressure and vehicle speed according to the load conditions. Check and retighten the straps frequently. Do not drive faster than 75 mph. The permissible roof load is:

- 80 kg for vehicles with roof railing
- 100 kg for vehicles without roof railing and with two roof racks
- 150 kg for vehicles without roof railing and with three roof racks, except vehicles with seven seats
- 100 kg for vehicles without roof railing and with three roof racks and seven seats



The roof load is the combined weight of the roof rack and the load.

### Overload indicator

The overload indicator checks whether the vehicle is overloaded. The function is designed to help avoiding overload and the consequent risks such as unstable road behaviour, tyre blowout, premature wear etc.



If an overcharge is imminent, **ON** and  are illuminated.

If the vehicle is overloaded, **ON**,  and  are illuminated. In addition,  is illuminated in the instrument cluster.



## Activation

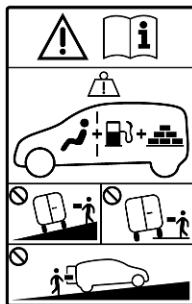

### Notice

For optimal operation, park the vehicle on a horizontal surface.

Do not park the vehicle on a slope.

Do not park the vehicle with the wheels on the pavement.

The system is activated automatically each time the engine is started. In addition, the system can be activated manually by pressing **ON** in the loading area. After activation, the system operates for five minutes.

# Instruments and controls

<b>Controls</b> .....	<b>89</b>
Steering wheel adjustment .....	89
Steering wheel controls .....	89
Heated steering wheel .....	89
Horn .....	90
Windscreen wiper and washer ..	90
Rear window wiper and washer .....	92
Outside temperature .....	92
Clock .....	93
Power outlets .....	93
Inductive charging .....	94
Cigarette lighter .....	95
Ashtrays .....	96
<b>Warning lights, gauges and indicators</b> .....	<b>96</b>
Instrument cluster .....	96
Speedometer .....	97
Odometer .....	97
Trip odometer .....	97
Tachometer .....	98
Fuel gauge .....	98
Engine coolant temperature gauge .....	99

Engine oil level monitor .....	99
Service display .....	99
Control indicators .....	100
Turn lights .....	100
Seat belt reminder .....	101
Airbag and belt tensioners .....	101
Airbag deactivation .....	102
Charging system .....	102
Malfunction indicator light .....	102
Service vehicle soon .....	102
Stop engine .....	102
System check .....	103
Brake and clutch system .....	103
Parking brake .....	103
Electric parking brake .....	103
Electric parking brake fault .....	103
Antilock brake system (ABS) ..	104
Gear shifting .....	104
Overload indicator .....	104
Descent control system .....	104
Lane keep assist .....	104
Electronic Stability Control and Traction Control system .....	104
Engine coolant temperature ..	104
Preheating .....	105
Exhaust filter .....	105
AdBlue .....	105
Deflation detection system .....	105
Engine oil pressure .....	105
Low fuel .....	106

Autostop .....	106
Exterior light .....	106
High beam .....	106
Low beam .....	106
High beam assist .....	106
LED headlights .....	106
Front fog lights .....	106
Rear fog light .....	107
Rain sensor .....	107
Cruise control .....	107
Adaptive cruise control .....	107
Side blind spot alert .....	107
Active emergency braking .....	107
Speed limiter .....	107
Door open .....	107
<b>Displays</b> .....	<b>108</b>
Driver Information Centre .....	108
Info Display .....	110
Head-up display .....	112
Rear view display .....	113
<b>Vehicle messages</b> .....	<b>114</b>
Warning chimes .....	114
<b>Vehicle personalisation</b> .....	<b>115</b>
<b>Telematics services</b> .....	<b>119</b>
Vauxhall Connect .....	119

## Controls

### Steering wheel adjustment

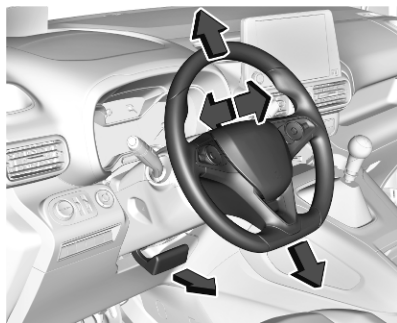

Unlock lever, adjust steering wheel, then engage lever and ensure it is fully locked.

Do not adjust steering wheel unless vehicle is stationary and steering wheel lock has been released.

### Steering wheel controls



Cruise control and speed limiter are operated via the controls on the left side of the steering wheel.

Additionally, adaptive cruise control can be set by using the controls on the left side of the steering wheel.

Infotainment system can be operated via the controls on the right side of the steering wheel.

Further information is available in the Infotainment manual.

Driver assistance systems ⇨ 167.

### Heated steering wheel

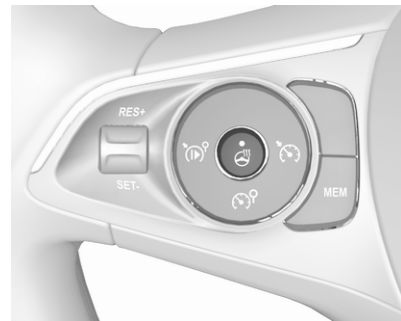

Activate heating by pressing . Activation is indicated by the LED in the button.

Heating is operational when the engine is running and during an Autostop.

Stop-start system ⇨ 147.

## Horn



Press .

## Windscreen wiper and washer

## Windscreen wiper with adjustable wiper frequency

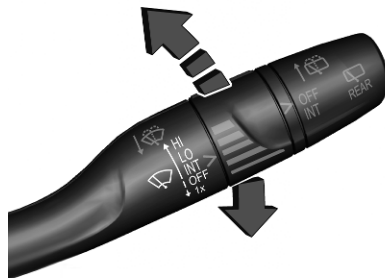

**HI** : fast  
**LO** : slow  
**INT** : interval wiping  
**OFF** : off

For a single wipe when the windscreen wiper is off, press the lever down to position **1x**.

Do not use if the windscreen is frozen.

Switch off in car washes.

To activate interval wiping mode the next time ignition is switched on, press the lever downwards to position **OFF** and back to **INT**.

## Adjustable wiper frequency



Wiper lever in position **INT**.

Turn the adjuster wheel to adjust the desired wipe frequency.

### Windscreen wiper with rain sensor

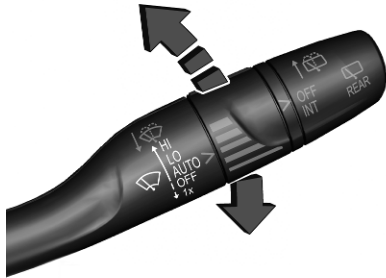

- HI** : fast  
**LO** : slow  
**AUTO** : automatic wiping with rain sensor  
**OFF** : off

In **AUTO** position, the rain sensor detects the amount of water on the windscreen and automatically regulates the frequency of the windscreen wiper. If ignition is switched off, automatic wiping mode is deactivated. To activate automatic wiping mode the next time ignition is

switched on, press the lever downwards to position **OFF** and back to **AUTO**.

For a single wipe when the windscreen wiper is off, press the lever downwards to position **1x**.

Do not use if the windscreen is frozen.

Switch off in car washes.

### Adjustable sensitivity of the rain sensor

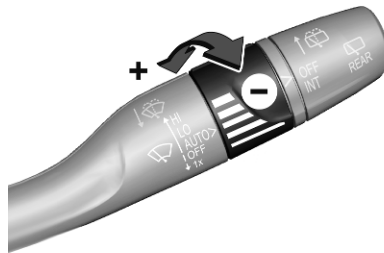

Turn the adjuster wheel to adjust the sensitivity.

Make sure the sensor is not blocked  
 ⇨ 40, ⇨ 10.

Control indicator  ⇨ 90.

### Windscreen washer



Pull lever. Washer fluid is sprayed onto the windscreen and the wiper wipes a few times.

Washer fluid ⇨ 216.

## Rear window wiper and washer

### Rear window wiper



**OFF** : off

**INT** : intermittent operation

Do not use if the rear window is frozen.

Switch off in car washes.

The rear window wiper comes on automatically when the windscreen wiper is switched on and reverse gear is engaged.

Activation or deactivation of this function can be changed in the Vehicle personalisation menu ↗ 115.

### Rear window washer



Push lever.

Washer fluid is sprayed onto the rear window and the wiper wipes a few times.

The rear window washer system is deactivated when the fluid level is low.

Washer fluid ↗ 216.

## Outside temperature

A drop in temperature is indicated immediately and a rise in temperature after a time delay.



Illustration shows an example.

If outside temperature drops to 3 °C, a warning message is displayed in the Driver Information Centre.

### **Warning**

The road surface may already be icy even though the display indicates a few degrees above 0 °C.

## Clock

Date and time are shown in the Info Display.

The adjustment of date and time is described in the Infotainment Manual.

Info Display ⇨ 110.

## Power outlets



A 12 V power outlet is located behind the storage cover. Push cover upwards to open.

Depending on the version, the 12 V power outlet may be freely accessible.

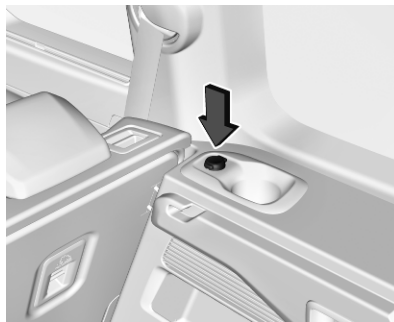

At the right side of the load compartment, another 12 V power outlet may be located.

Do not exceed the maximum power consumption of 120 W.

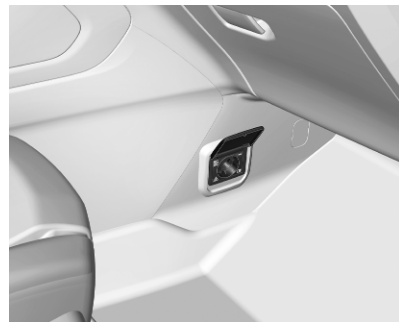

A 230 V power outlet may be located on the lower side of the centre console in the front passenger compartment.

Do not exceed the maximum power consumption of 150 W.

With ignition off, the power outlets are deactivated. Additionally the power outlets are deactivated in the event of low vehicle battery voltage.

Electrical accessories that are connected must comply with the electromagnetic compatibility requirements laid down in DIN VDE 40 839.

Do not connect any current-delivering accessories, e.g. electrical charging devices or batteries.

Do not damage the outlet by using unsuitable plugs.

Stop-start system ↪ 147.

## USB ports



A USB port is located in the instrument panel next to the Info Display.

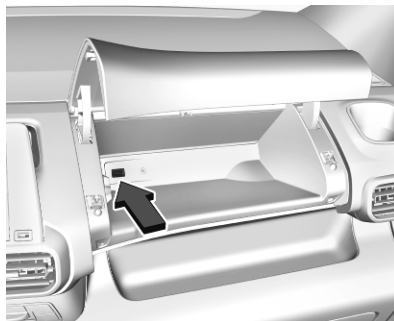

A USB port may be located within the compartment located above the glovebox.



A further USB port may be located in the rear console.

The USB ports are prepared for charging external devices and provide a data connection to the Infotainment system. For further information, see Infotainment manual.

### Notice

The sockets must always be kept clean and dry.

## Inductive charging

### ⚠ Warning

Inductive charging can affect the operation of implanted pacemakers or other medical devices. If applicable, seek medical advice before using the inductive charging device.



**⚠ Warning**

Remove any metal objects from the charging device before charging a mobile device, as these objects could become very hot.

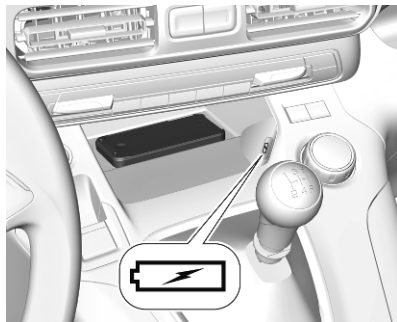

The portable device to be charged must be compatible with the Qi standard, either by design or by using a compatible holder or shell. The charging zone is identified by the Qi symbol.

To charge a device, the ignition must be switched on.

To charge a mobile device:

1. Remove all objects from the charging device.
2. Place the mobile device with the display facing upwards on the charging device in the storage.

Charging status is indicated in the LED: illuminates green, when mobile device is charging.

Protective cover for the mobile device could have impact on the inductive charging.

In the event that the mobile device is not charging properly, rotate it 180° and place it on the charging device again.

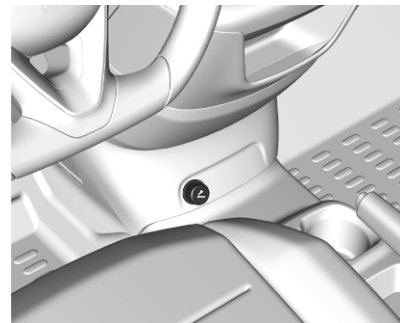
**Cigarette lighter**

The cigarette lighter is freely accessible.

Depending on version, the cigarette lighter may be located behind the storage cover. Press cover to open.

Press in cigarette lighter. It switches off automatically once the element is glowing. Pull out cigarette lighter.

## Ashtrays

### Caution

To be used only for ash and not for combustible rubbish.



A portable ashtray can be placed in the cupholders.





## Warning lights, gauges and indicators













### Instrument cluster

















Depending on the version, the Driver Information Centre may vary.





### Overview

-  Turn signal ⇨ 100
-  Seat belt reminder ⇨ 101
-  Airbag and belt tensioners ⇨ 101
-  Airbag deactivation ⇨ 102
-  Charging system ⇨ 102

-  Malfunction indicator light ⇨ 102
-  Service vehicle soon ⇨ 102
- STOP** Stop engine ⇨ 102
-  System check ⇨ 103
-  Brake and clutch system ⇨ 103
-  Parking brake ⇨ 103
- Electric parking brake ⇨ 103
-  Antilock brake system (ABS) ⇨ 104
-  Gear shifting ⇨ 104
-  Lane keep assist ⇨ 104
-  Electronic Stability Control and Traction Control system ⇨ 104
-  Preheating ⇨ 105
-  Exhaust filter ⇨ 105
-  AdBlue ⇨ 105

-  Deflation detection system  
↪ 105
-  Engine oil pressure ↪ 105
-  ● Low fuel ↪ 106
-  ● Engine coolant temperature high ↪ 104
-  (A) Autostop ↪ 106
-  ➤ Exterior light ↪ 106
-  Low beam ↪ 106
-  High beam ↪ 106
-  High beam assist ↪ 106
-  Descent control system  
↪ 104
-  Front fog lights ↪ 106
-  Rear fog light ↪ 107
-  Rain sensor ↪ 107
-  Side blind spot alert ↪ 107
-  Cruise control ↪ 107
-  Speed limiter ↪ 107

-  Active emergency braking  
↪ 179
-  Door open ↪ 107
-  Overload indicator ↪ 104

## Speedometer

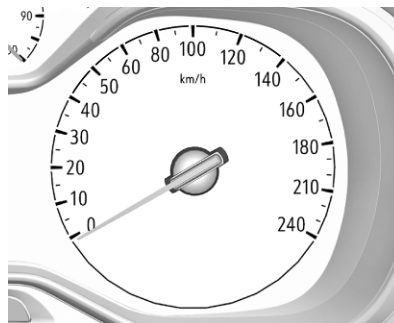

Indicates vehicle speed.

## Odometer

The total recorded distance is displayed in miles.

## Driver Information Centre

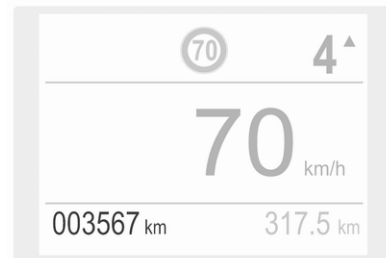

## Trip odometer

The recorded distance since the last reset is displayed in the Driver Information Centre.

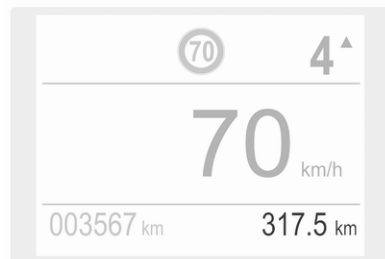

### Monochrome display

Trip odometer counts up to 9,999.9 miles without automatic reset.

Press **000** for 2 seconds to reset trip odometer.

### Colour display

Trip odometer counts up to 1,999.9 miles and resets then automatically.

Press **000** for 2 seconds to reset trip odometer.

The trip / fuel information menu provides additionally two trip counter ↻ 108.

### Tachometer

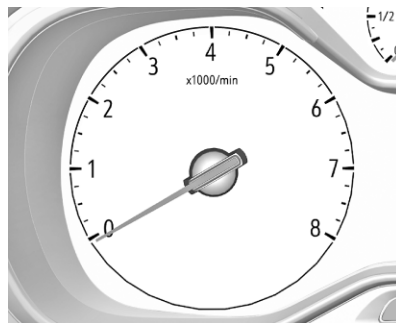

Displays the engine speed.

Drive in a low engine speed range for each gear as much as possible.

A red marker indicates the beginning of the warning zone of excessive revolutions. For Diesel engines, the warning zone starts at 5000 revolutions per minute. For petrol engines, the warning zone starts at 7000 revolutions per minute.

### Caution

If the needle is beyond the red marker, the maximum permitted engine speed is exceeded. Engine at risk.

### Fuel gauge



Displays the fuel level.

Control indicator ● illuminates if the fuel level is low.

Never run the fuel tank dry.

Because of the fuel remaining in the tank, the top-up quantity may be less than the specified fuel tank capacity.

## Engine coolant temperature gauge

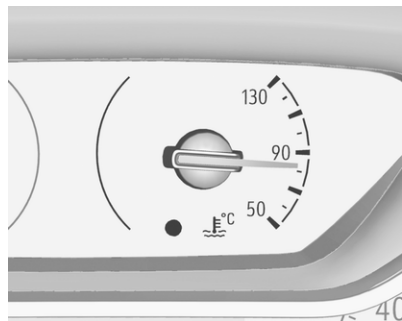

Displays the coolant temperature.

- 50 : engine operating temperature not yet reached
- 90 : normal operating temperature
- 130 : temperature too high

Control indicator ● illuminates if coolant temperature is too high. Switch off engine immediately.



### Caution

If engine coolant temperature is too high, stop vehicle, switch off engine. Danger to engine. Check coolant level.

## Engine oil level monitor

The state of the engine oil level is displayed in the Driver Information Centre for a few seconds following the service information after switching on the ignition.

A proper state of engine oil level is indicated by the message **Oil level correct**.

If engine oil level is low,  flashes and **Oil level incorrect** is indicated, accompanied by . Confirm engine oil level by using the oil dipstick and top up engine oil respectively.

Engine oil ⇨ 214.

A fault of measurement is indicated by the message **Oil level measurement invalid**. Check engine oil level manually by using the dipstick.

## Service display

The service system informs when to change the engine oil and filter or a vehicle service is required. Based on driving conditions, the interval at which an engine oil and filter change is required can vary considerably.

Service information ⇨ 251.

A required service due is displayed in the Driver Information Centre for seven seconds after switching on the ignition.

If no service is required for the next 1800 miles or more no service information appears in the display.

If service is required within the next 1800 miles, the remaining distance or time duration is indicated for several seconds. Simultaneously  illuminates permanently as reminder.

If service is required in less than 600 miles,  flashes and then illuminates permanently. Remaining distance or time duration is indicated for several seconds.

Overdue service is indicated by a message in the Driver Information Centre which indicates the overdue distance.  flashes and then illuminates permanently until service is executed.

### Reset of service interval

After each service, the service indicator must be reset to ensure proper functionality. It is recommended to seek the assistance of a workshop.

If service is executed by yourself, operate as following:

- switch off ignition
- press and hold button CHECK
- switch on ignition, the distance indication begins a countdown
- when the display indicates =0, release the button  disappears

### Retrieving service information



To retrieve the status of the service information at any time press button **CHECK**. The service information is displayed for a few seconds.

Service information ⇨ 251.

### Control indicators

The control indicators described are not present in all vehicles. The description applies to all instrument versions. Depending on the equipment, the position of the control indicators may vary. When the

ignition is switched on, most control indicators will illuminate briefly as a functionality test.

The control indicator colours mean:

- red : danger, important reminder
- yellow : warning, information, fault
- green : confirmation of activation
- blue : confirmation of activation
- white : confirmation of activation
- grey : system paused, at least one system limitation has been detected

See all control indicators on different instrument clusters ⇨ 96.

### Turn lights

 illuminates or flashes green.

### Illuminates briefly

The parking lights are switched on.

### Flashes

Turn lights or the hazard warning flashers are activated.

Rapid flashing: failure of a turn light or associated fuse, failure of turn light on trailer.



Bulb replacement ⇨ 220.

Turn lights ⇨ 125.

## Seat belt reminder

 illuminates or flashes in the instrument cluster. Additionally, there is an indication in the roof console. The big symbols refer to the seat belts of the front seats, the small symbols refer to the second row rear seats.



- When the ignition is switched on,  in the instrument cluster and the symbols in the roof console come on for a short time. For the front seats,  in the instrument

cluster and the symbols in the roof console illuminate until seat belt is fastened.

- When driving faster than 12 mph and a seat belt is unfastened, the symbol in the roof console for the respective seat flashes and a chime is audible. For the second row rear seats, this only applies if at least one rear seat belt was previously fastened.

Additionally,  illuminates in the instrument cluster.

After two minutes the chime goes off and  in the roof console illuminates constantly until the seat belt of the respective seat is fastened.

## Airbag and belt tensioners

 illuminates red.

When the ignition is switched on, the control indicator illuminates for approx. four seconds. If it does not illuminate, does not extinguish after four seconds or illuminates whilst driving, there is a fault in the airbag

system. Seek the assistance of a workshop. The airbags and belt pretensioners may fail to trigger in the event of an accident.

Deployment of the belt pretensioners or airbags is indicated by continuous illumination of .

### Warning

Have the cause of the fault remedied immediately by a workshop.

Belt pretensioners ⇨ 54.

Airbag system ⇨ 57.

## Airbag deactivation



 **ON** illuminates yellow.

The front passenger airbag is activated.

 **OFF** illuminates yellow.

The front passenger airbag is deactivated.

Airbag deactivation ⇨ 62.

## Charging system

 illuminates red.

Illuminates when the ignition is switched on and extinguishes shortly after the engine starts.

## Illuminates when the engine is running

Stop, switch off engine. Vehicle battery is not charging. Engine cooling may be interrupted. The brake servo unit may cease to be effective. Seek the assistance of a workshop.

## Malfunction indicator light

 illuminates or flashes yellow.

Illuminates when the ignition is switched on and extinguishes shortly after the engine starts.

## Illuminates when the engine is running

Fault in the emission control system. The permitted emission limits may be exceeded. Seek the assistance of a workshop immediately.

## Flashes when the engine is running

Fault that could lead to catalytic converter damage. Ease up on the accelerator until the flashing stops. Seek the assistance of a workshop immediately.

## Service vehicle soon

 illuminates yellow.

Illuminates briefly when the ignition is switched on.

May illuminate together with other control indicators and a corresponding message in the Driver Information Centre.

Seek the assistance of a workshop immediately.

## Stop engine

**STOP** illuminates red.

Illuminates briefly when the ignition is switched on.



Illuminates together with other control indicators, accompanied by a warning chime and a corresponding message in the Driver Information Centre.

Stop engine immediately and seek the assistance of a workshop.

## System check

 illuminates yellow or red.

### Illuminates yellow

A minor engine fault has been detected.

### Illuminates red

A major engine fault has been detected.

Stop engine as soon as possible and seek the assistance of a workshop.

## Brake and clutch system

 illuminates red.

The brake and clutch fluid level is too low.

### Warning

Stop. Do not continue your journey. Consult a workshop.

## Parking brake

 illuminates red.

Illuminates when the manual parking brake is applied and ignition is switched on  160.

## Electric parking brake

 illuminates or flashes red.

### Illuminates

Electric parking brake is applied  160.

### Flashes

Electric parking brake is not applied automatically. The application or the release is faulty.

### Warning

Have the cause of the fault remedied immediately by a workshop.

 illuminates yellow.

### Illuminates

Automatic operation is deactivated or faulty. Activate automatic operation again or have the cause remedied by a workshop in the event of a fault.

Automatic operation  160.

## Electric parking brake fault

 illuminates yellow.

### Illuminates

Electric parking brake has a fault  160.

### Warning

Have the cause of the fault remedied immediately by a workshop.

## Antilock brake system (ABS)

 illuminates yellow.

Illuminates for a few seconds after the ignition is switched on. The system is ready for operation when the control indicator extinguishes.

If the control indicator does not extinguish after a few seconds, or if it illuminates while driving, there is a fault in the ABS. The brake system remains operational but without ABS regulation.

Antilock brake system ⇨ 159.

## Gear shifting

▲ with the number of a higher gear is indicated, when upshifting is recommended for fuel saving reasons.

## Overload indicator

 illuminates.

Illuminates when the overload indicator detects an exceeding of the maximum authorised weight ⇨ 86.

## Descent control system

 illuminates or flashes green.

### Illuminates green

The system is switched on and ready to operate.

### Flashes green

The system is in operation.

## Lane keep assist

 illuminates green or yellow, or flashes yellow.

### Illuminates green

The system is switched on and ready to operate.

### Illuminates yellow

The system approaches a detected lane marking without using the turn light in that direction.

### Flashes yellow

The system recognizes that the lane is departed significantly.

Lane keep assist ⇨ 198.

## Electronic Stability Control and Traction Control system

 illuminates or flashes yellow.

### Illuminates

A fault in the system is present. Continued driving is possible. Driving stability, however, may deteriorate depending on road surface conditions.

Have the cause of the fault remedied by a workshop.

### Flashes

The system is actively engaged. Engine output may be reduced and the vehicle may be braked automatically to a small degree.

Electronic Stability Control and Traction Control system ⇨ 163.

Selective ride control ⇨ 165.

## Engine coolant temperature

● illuminates red.

## Illuminates when the engine is running

Stop, switch off engine.

<b>Caution</b>
Coolant temperature too high.

Coolant temperature too high.

Check coolant level immediately  
 215.



If there is sufficient coolant, consult a workshop.

## Preheating

 illuminates yellow.

Preheating of diesel engine is activated. Only activates when outside temperature is low. Start the engine when control indicator extinguishes.

## Exhaust filter

 or  illuminates yellow, accompanied by a message in the Driver Information Centre.

The exhaust filter requires cleaning.

Continue driving until the control indicator extinguishes.

## Illuminates temporarily

Start of saturation of the exhaust filter. Start cleaning process as soon as possible by driving at a vehicle speed of at least 40 mph.

## Illuminates constantly

Indication of a low additive level. Seek the assistance of a workshop.

Exhaust filter  151.

## AdBlue

 flashes or illuminates yellow.

## Illuminates yellow

The remaining driving range is between 500 miles and 1500 miles.

## Flashes yellow

The remaining driving range is between 0 miles and 500 miles.

AdBlue level is low. Refill AdBlue soon to avoid prevention of the engine start.

AdBlue  152.

## Deflation detection system

 illuminates or flashes yellow.

## Illuminates

Tyre pressure loss in one or more wheels. Stop immediately and check tyre pressure.

## Flashes

Fault in system. Consult a workshop. Deflation detection system  233.

## Engine oil pressure

 illuminates red.

Illuminates when the ignition is switched on and extinguishes shortly after the engine starts.

**Illuminates when the engine is running****Caution**

Engine lubrication may be interrupted. This may result in damage to the engine and / or locking of the drive wheels.

1. Select neutral gear.
2. Move out of the flow of traffic as quickly as possible without impeding other vehicles.
3. Switch off ignition.

**⚠ Warning**

When the engine is off, considerably more force is needed to brake and steer. During an Autostop the brake servo unit will still be operational.

Do not remove key until vehicle is stationary, otherwise the steering wheel lock could engage unexpectedly.

Keep engine turned off and let the vehicle be towed to a workshop.

**Low fuel**

- illuminates yellow.
- Level in fuel tank is too low.  
Refuelling ⇨ 204.  
Bleeding the diesel fuel system ⇨ 219.

**Autostop**

(A) illuminates or flashes green.

**Illuminates green**

Engine is in an Autostop.

**Flashes green**

Autostop is temporarily unavailable, or Autostop mode is invoked automatically.  
Stop-start system ⇨ 147.

**Exterior light**

➤ illuminates green.  
The exterior lights are on ⇨ 121.

**High beam**

≡D illuminates blue.  
Illuminates when high beam is on, during headlight flash ⇨ 122.

**Low beam**

≡D illuminates green.  
Illuminated when low beam is on.

**High beam assist**

≡D illuminates green.  
The high beam assist is activated ⇨ 122.

**LED headlights**

🔑 illuminates and a warning message is displayed in the Driver Information Centre.  
Seek the assistance of a workshop.

**Front fog lights**

⚡D illuminates green.  
The front fog lights are on ⇨ 125.

## Rear fog light

 illuminates yellow.

The rear fog light is on ⇨ 125.

## Rain sensor

 illuminates green.

Illuminated when rain sensor position on wiper lever is selected.

## Cruise control

 illuminates white or green.

### Illuminates white

The system is on.

### Illuminates green

Cruise control is active. Set speed is indicated in the Driver Information Centre.

Cruise control ⇨ 167.

## Adaptive cruise control

 illuminates white or green.

 illuminates in the Driver Information Centre.

### illuminates white

The system is on.

### illuminates green

Adaptive cruise control is active.

When Adaptive cruise control is on or active,  with the set speed is indicated in the Driver Information Centre.

Adaptive cruise control ⇨ 171.

## Side blind spot alert

 illuminates continuously green in the instrument cluster.

The system is active ⇨ 191.

## Active emergency braking

 illuminates or flashes yellow.

### Illuminates

The system has been deactivated or a fault has been detected.

Additionally, a warning message is displayed in the Driver Information Centre.

Check the reason of the deactivation ⇨ 179 and in case of a system fault, seek the assistance of a workshop.

## Flashes

The system is actively engaged.



Depending on the situation, the vehicle may automatically brake moderately or hard.

Forward collision alert ⇨ 178.

Front pedestrian protection ⇨ 182.

Active emergency braking ⇨ 179.

## Speed limiter

 illuminates in the Driver Information Centre when speed limiter is active. Set speed is indicated alongside  symbol.

Speed limiter ⇨ 169.

## Door open

 illuminates red.

A door or the tailgate is open.

## Displays

### Driver Information Centre

The Driver Information Centre is located in the instrument cluster.

Driver Information Centre indicates:

- overall and trip odometer
- digital speed indication
- trip / fuel information menu
- gear shift indication
- service information
- vehicle and warning messages
- driver assistance messages
- pop-up messages

### Selecting menus and functions

The menus and functions can be selected via the buttons on the indicator lever.

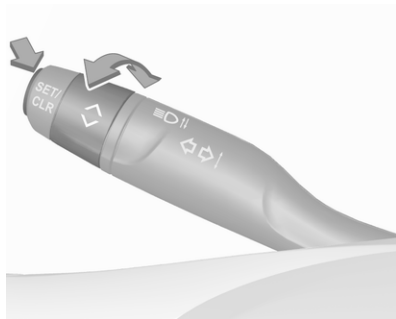

Turn the adjuster wheel to select a page in the trip / fuel information menu.

Press **SET / CLR** to confirm or reset a function.

Vehicle and service messages are popped up in the Driver Information Centre if required. Scroll messages by turning the adjuster wheel. Confirm messages by pressing **SET / CLR**.

Additionally, some menus can be selected via the **CHECK** button.



Press **CHECK** to switch between the respective menus.

Vehicle messages ⇨ 114.

### Trip / fuel information menu, Midlevel display

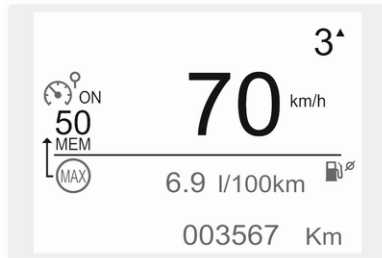

Select the required page:

#### Trip odometer

The recorded distance since the reset.

Press **000** for 2 seconds to reset trip odometer.

#### Average fuel consumption

Display of average consumption. The measurement can be reset at any time and starts with a default value. To reset, press **SET/CLR** for a few seconds.

#### Average speed

Display of average speed. The measurement can be reset at any time.

To reset, press **SET/CLR** for a few seconds.

#### Fuel range

Range is calculated from current fuel level and current consumption. The display shows average values.

After refuelling, the range is updated automatically after a brief delay.

When the fuel level is low, a message appears on the display and the control indicator ● in the fuel gauge illuminates ⇨ 106.

#### Instantaneous Fuel Consumption

Display of the instantaneous consumption.

#### Digital speed

Digital display of the instantaneous speed.

### Trip / fuel information menu, Uplevel display



Different pages with combined information can be selected.

Select the required page:

#### Information page:

##### Fuel range

Range is calculated from current fuel level and current consumption. The display shows average values.

After refuelling, the range is updated automatically after a brief delay.

When the fuel level is low, a message appears on the display and the control indicator ● in the fuel gauge illuminates ⇨ 106.

### **Instantaneous Fuel Consumption**

Display of the instantaneous consumption.

#### **Trip 1 page:**

##### **Average speed**

Display of average speed. The measurement can be reset at any time.

##### **Average fuel consumption**

Display of average consumption. The measurement can be reset at any time and starts with a default value.

##### **Distance travelled**

Displays the current distance for trip 1 since the reset.

The values of trip 1 page can be reset by pressing **SET/CLR** for a few seconds.

#### **Trip 2 page:**

##### **Average speed**

Display of average speed. The measurement can be reset at any time.

##### **Average fuel consumption**

Display of average consumption. The measurement can be reset at any time and starts with a default value.

##### **Distance travelled**

Displays the current distance for trip 2 since a certain reset.

The values of trip 2 page can be reset by pressing **SET/CLR** for a few seconds.

##### **Digital speed page**

Digital display of the instantaneous speed.

##### **Stop and Start time counter**

A time counter calculates the time spent in STOP mode during a journey. It resets to zero every time the ignition is switched on.

##### **Compass page**

Displays the geographic direction of driving.

##### **Blank page**

No trip/fuel information is displayed.

##### **AdBlue**

Press **CHECK** repeatedly until the AdBlue menu is shown.

##### **AdBlue range**

Indicates an estimate of the AdBlue level. A message indicates whether the level is sufficient or low.

⇨ 152.

### **Info Display**

The Info Display is located in the instrument panel near the instrument cluster.

Depending on the vehicle configuration the vehicle has a

- **Graphic Info Display**  
or
- **Colour Info Display** with touchscreen functionality

The Info Displays can indicate:

- time ⇨ 93
- outside temperature ⇨ 92



- date ↗ 93
- Infotainment system, see description in the Infotainment manual
- indication of rear view camera ↗ 196
- indication of panoramic view system ↗ 193
- indication of parking assist instructions ↗ 183
- navigation, see description in the Infotainment manual
- vehicle and system messages ↗ 114
- settings for vehicle personalisation ↗ 115

### Graphic Info Display

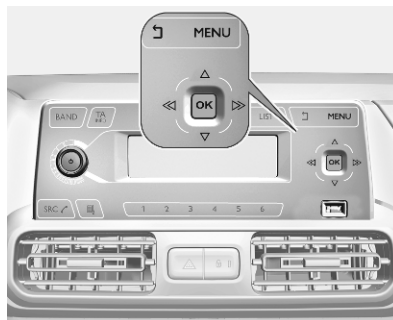

Press  to switch on the display.

Press **MENU** to select main menu page.

Press     to select a menu page.

Press **OK** to confirm a selection.

Press  to exit a menu without changing a setting.

### Colour Info Display

#### Selecting menus and settings

There are three options to operate the display:

- via buttons next to the display
- by touching the touchscreen with the finger
- via speech recognition

#### Button and touch operation



Press  to switch on the display.

Press  to select system settings (units, language, time and date).

Press  to select vehicle settings or driving functions.

Touch required menu display icon or a function with the finger.

Confirm a required function or selection by touching.

Touch ← on the display to exit a menu without changing a setting.

For further information, see Infotainment manual.

### Speech recognition

Description see Infotainment manual.

Vehicle personalisation ↗ 115.

## Head-up display

The head-up display displays driver information concerning the instrument cluster onto a foldable projection plane on the driver's side.

The information appears as an image projected from a lens in the instrument panel onto the projection plane directly ahead in driver's view.

The image appears focused out toward the front of the vehicle.

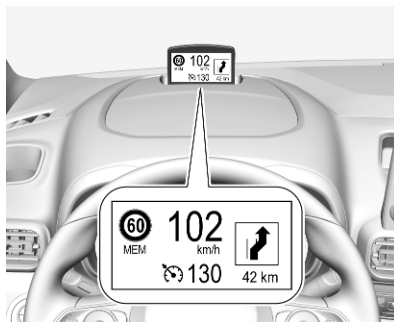

Head-up display shows:

- vehicle speed
- speed limits detected by the speed sign recognition
- set speed of speed limiter
- set speed of cruise control
- forward collision alert
- navigation information.



### Switching on

Press ☀ to switch on the head-up display.

### Adjust position of head-up display image

Press ▲ or ▼ to centre the image. It can only be adjusted up and down, not side to side.

### ⚠ Warning

If the head-up display image is too bright or too high in your field of view, it may obstruct your view

when it is dark outside. Be sure to keep the head-up display image dim and placed low in your field of view.

### Adjust brightness

The head-up display image will automatically dim and brighten to compensate for outside lighting. Brightness can also be adjusted manually as needed:

Press ☀ to brighten the display. Press 🌙 to dim the display.

The image can temporarily illuminate depending on angle and position of sunlight.

### Switching off

Press 🌙 and hold to turn the head-up display off.

### Language

Preferred language can be set in vehicle personalisation menu ↪ 115.

### Units

Units can be changed in vehicle personalisation menu ↪ 115.

### Care of head-up display

Clean the screen of the head-up display with a soft cloth sprayed with glass cleaner. Wipe the lens gently, then dry it.

### System limitations

Head-up display may not operate properly when:

- The lens in the instrument panel is covered by objects or not clean.
- Display brightness is too dim or bright.
- Image is not adjusted to the proper height.
- The driver wears polarized sunglasses.

If the head-up image is not correct for other reasons, contact a workshop.

### Rear view display

The rear view display is located at the position of the interior mirror.

It provides the following views:

- standard rear view ↪ 39
- close rear view ↪ 196
- passenger side view ↪ 192

### Switching on



Press ⏻ and confirm the message with 🗨️.

### Selecting a view



Select the standard rear view or passenger side view by pressing the  on the bottom side.

Close rear view is automatically activated when reverse gear is engaged.

### Switching off

Press .

## Vehicle messages

Messages are indicated in the Driver Information Centre, in some cases together with a warning chime.



Press **SET / CLR** to confirm a message.

### Vehicle and service messages

The vehicle messages are displayed as text. Follow the instructions given in the messages.

### Messages in the Colour Info Display

Some important messages may appear additionally in the Info Display. Some messages only pop-up for a few seconds.

### Warning chimes

If several warnings appear at the same time, only one warning chime will sound.

### When starting the engine or whilst driving

The warning chime regarding not fastened seat belts has priority over any other warning chime.

- If a seat belt is not fastened.
- If a door or the tailgate is not fully closed.
- If a certain speed is exceeded with parking brake applied.
- If cruise control deactivates automatically.
- If a programmed speed or speed limit is exceeded.

- If a warning message appears in the Driver Information Centre.
- If the electronic key is not in the passenger compartment.
- If the parking assist detects an object.
- If an unintended lane change occurs.
- If the exhaust filter has reached the maximum filling level.

### When the vehicle is parked and / or the driver's door is opened

- With exterior lights on.

### During an Autostop

- If the driver's door is opened.
- If any condition for a restart of the engine is not fulfilled.

## Vehicle personalisation

The vehicle's behaviour can be personalised by changing the settings in the Info Display.

Depending on vehicle equipment and country-specific regulations some of the functions described below may not be available.

Some functions are only displayed or active when the engine is running.

### Graphic Info Display

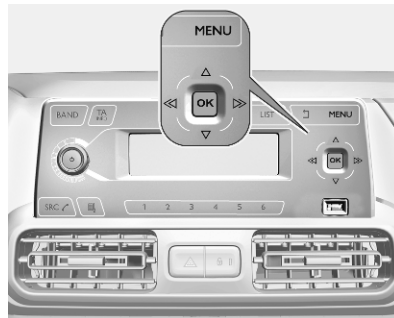

Press **MENU** to open the menu page.  
Use four-way button to operate the display:

Select **Personalisation-configuration**,  
➔ **OK**.

#### Unit settings

Select **Display configuration**, ➔ **OK**.

Select **Choice of units**, ➔ **OK**.

Select desired settings, ➔ **OK**.

#### Language settings

Select **Display configuration**, ➔ **OK**.

Select **Choice of language**, ➔ **OK**.

Select desired language, ➔ **OK**.

#### Vehicle settings

Select **Define vehicle parameters**, ➔ **OK**.

In the corresponding submenus the following settings can be changed:

- **Lamps**

#### Follow me home headlamps:

Activates or deactivates the function and adjusts its duration.

**Welcome lighting:** Activates or deactivates the function and adjusts its duration.

**Directional headlights:** Activates or deactivates the function.

- **Comfort**

**Ambient lighting:** Adjusts the brightness of the ambient lighting.

**Rear wiper in reverse gear:** Activates or deactivates automatic switching on of the rear window wiper when reverse gear is engaged.

- **Vehicle**

**Unlocking boot only:** Activation / deactivation.

**Plip action:** Driver / all doors.

- **Security**

**Fatigue Detection system:** Activates or deactivates the driver drowsiness system.

- **Driving assistance**

**Speed recommendation:** Activates or deactivates the function.

## Colour Info Display Multimedia



Press  to open settings menu.

Use touch buttons to operate the display.

### Unit settings

Select **System configuration**.

Change units for **Distance and fuel consumption** and **Temperature**.

### Language settings

Select **Language**.

Change language by touching the respective entry.

## Driving function

Press .

Select **Driving function**.

In the corresponding submenus the following settings can be changed:

- **Park Assist:** Activates advanced park assist, a parking maneuver can be selected.
- **Parking sensors:** Activates or deactivates the parking sensors.
- **Blind spot sensors:** Activates or deactivates side blind spot alert.
- **Under-inflation initialization:** Initialises the tyre under-inflation detection system.
- **Diagnostic:** Shows alert messages of the diagnostic system.

## Vehicle settings



Press .

Select **Vehicle settings**.

In the corresponding submenus the following settings can be changed:

- **Parking**

**Prevention of door mirror folding:** Activates or deactivates the automatic folding of the exterior mirrors.

**Rear wiper in reverse:** Activates or deactivates automatic switching on of the rear window wiper when reverse gear is engaged.

- **Headlights**

**Guide-me-home lighting:** Activates or deactivates the function and adjusts its duration.

**Welcome lighting:** Activates or deactivates the function and adjusts its duration.

**Directional headlamps:** Activates or deactivates the cornering lights.

- **Comfort**

**Mood lighting:** Adjusts the brightness of the ambient lighting.

- **Safety**

**Speed reading/recommendation:** Activates or deactivates the speed limit information by traffic sign recognition.

**Active safety brake:** Activates or deactivates active emergency braking, the alert distance for risk of collision can be selected.

**Mirror adaptation in reverse:** Adjusts the exterior mirrors if reverse gear is engaged to facilitate sidewalks visibility.

**Driver's attention warning:** Activates or deactivates the driver drowsiness system.

## Colour Info Display Multimedia Navi Pro



Press  to open settings menu.

Use touch buttons to operate the display.

### Unit settings

Select **System settings**.

Change units for **Distance and fuel consumption** and **Temperature**.

Confirm with .

### Language settings

Select **Languages**.

Change language by touching the respective entry.

Confirm with ✓.

### Driving functions

Press .

Select **Driving functions**.

In the corresponding submenus the following settings can be changed:

- **Park Assist:** Activates advanced park assist, a parking maneuver can be selected.
- **Parking sensors:** Activates or deactivates the parking sensors.
- **Blind spot sensors:** Activates or deactivates side blind spot alert.
- **Under-inflation initialization:** Initialises the tyre under-inflation detection system.
- **Diagnostic:** Shows alert messages of the diagnostic system.

### Vehicle settings



Press .

Select **Vehicle settings**.

In the corresponding submenus the following settings can be changed:

- **Parking**
  - **Rear wiper in reverse:** Activates or deactivates automatic switching on of the rear window wiper when reverse gear is engaged.
  - **Blocking of door mirror folding:** Activates or deactivates the automatic folding of the exterior mirrors.

- **Headlights**

**Guide-me-home lighting:**

Activates or deactivates the function and adjusts its duration.

**Welcome lighting:** Activates or deactivates the function and adjusts its duration.

**Directional headlamps:** Activates or deactivates the cornering lights.

- **Comfort**

**Mood lighting:** Adjusts the brightness of the ambient lighting.

- **Safety**

**Traffic Signs Recognition:**

Activates or deactivates the speed limit information by traffic sign recognition.

**Active safety brake:** Activates or deactivates active emergency braking, the alert distance for risk of collision can be selected.

**Mirror adaptation in reverse:**

Adjusts the exterior mirrors if reverse gear is engaged to facilitate sidewalks visibility.



**Driver's attention warning:**  
Activates or deactivates the driver drowsiness system.

## Telematics services

### Vauxhall Connect

Vauxhall Connect is a new way to stay connected and secure on the road.

Features available with Vauxhall Connect are:

- emergency call function
- breakdown call function

When the vehicle is equipped with Vauxhall Connect, these features are automatically activated. Terms and Conditions apply.

Vauxhall Connect is operated by the buttons in the overhead console.

### Emergency call function

Vehicles featuring the emergency call function are equipped with a red **SOS** button in the overhead console.

The emergency call function will establish a connection to the nearest public safety answering point (PSAP). A minimum set of data including vehicle and location information will be sent to the PSAP.

### Notice

Establishing an emergency call may not be possible in areas without sufficient network availability or due to hardware damage during an accident.

### Automatic crash notification

In case of an accident with airbag deployment, an automatic emergency call is established and an automatic crash notification will be transmitted to the next public safety answering point.

### Emergency assistance

In case of an emergency you can also manually place an emergency call by pressing the red **SOS** button for more than two seconds. The LED flashes to confirm that a connection to the nearest PSAP is being established. The LED illuminates steadily as long as the call is active.

Pressing the **SOS** button immediately a second time will terminate the call. The LED switches off.

### **Status LED**

Illuminates green and red and extinguishes after a short time, when the ignition is switched on: the system works properly.

Illuminates red: fault in the system.  
Contact a workshop.

Flashes red: backup battery needs replacement.

### **Breakdown call function**

Pressing  for more than two seconds connects you to a roadside assistance service provider.

For information about coverage and scope of services of the roadside assistance, please refer to the Service and warranty booklet.

## Lighting

<b>Exterior lighting</b> .....	<b>121</b>
Light switch .....	121
Automatic light control .....	122
High beam .....	122
High beam assist .....	122
Headlight flash .....	123
Headlight range adjustment ....	124
Headlights when driving	
abroad .....	124
Daytime running lights .....	124
Hazard warning flashers .....	124
Turn lights .....	125
Front fog lights .....	125
Rear fog light .....	125
Parking lights .....	126
Reversing lights .....	126
Misted light covers .....	126
<b>Interior lighting</b> .....	<b>126</b>
Instrument panel illumination	
control .....	126
Interior lights .....	127
Reading lights .....	127
Sunvisor lights .....	127
<b>Lighting features</b> .....	<b>128</b>
Centre console lighting .....	128

Entry lighting .....	128
Exit lighting .....	128
Vehicle locator lighting .....	129
Peripheral lighting .....	129
Battery discharge protection ....	129

## Exterior lighting

### Light switch



Turn light switch:

- AUTO** : automatic light control switches automatically between daytime running light and headlight
- ☞☞ : sidelights
- ☞☞☞ : headlights

When switching on the ignition, automatic light control is active.

Control indicator ☞☞☞ 106.

## Tail lights

Tail lights are illuminated together with low/high beam and sidelights.

## Automatic light control



When the automatic light control function is switched on and the engine is running, the system switches between daytime running lights and headlights automatically depending on the external lighting conditions and information given by the wiper system.

Make sure the sensor is not blocked  
 ⇨ 10, ⇨ 40.

Daytime running light ⇨ 124.

## Automatic headlight activation

During poor lighting conditions the headlights are switched on.

Additionally, headlights are switched on if the windscreen wipers have been activated for several wipes.

## Tunnel detection

When a tunnel is entered, headlights are switched on immediately.

## High beam

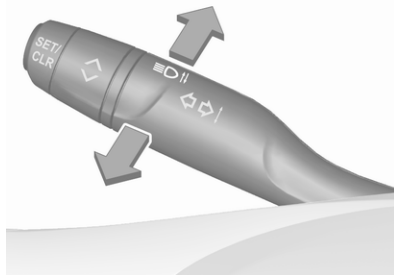

Push lever to switch from low to high beam.

Pull lever to deactivate high beam.

## High beam assist

This feature automatically activates the high beam at night when vehicle is faster than 15 mph.

It switches automatically back to low beam when:

- A sensor detects the lights of oncoming or preceding vehicles.
- Driving in urban areas.
- The vehicle is slower than 9 mph.
- It is foggy or snowy.
- Front or rear fog lights are switched on.



If there are no restrictions detected, the system switches back to high beam.

## Activation

### Indicator lever with button



Activate high beam assist by pressing  once.

The green control indicator  illuminates continuously when the assist is activated, the blue one  illuminates when high beam is on.

Control indicator   106.

## Deactivation

With high beam on, pull the indicator lever once to deactivate high beam assist. If a headlight flash is activated when the high beam is off, the high beam assist will remain activated.

Pushing the indicator lever to activate manual high beam will deactivate high beam assist. It is also deactivated when fog lights are switched on.

Press  once to deactivate high beam assist.

The latest setting of the high beam assist is being stored and remains set when the ignition is switched on again.

## Headlight flash

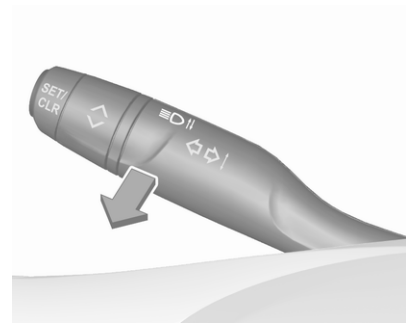

To activate the headlight flash, pull lever.

Pulling lever deactivates high beam.

## Headlight range adjustment

### Manual headlight range adjustment



To adapt headlight range to the vehicle load to prevent dazzling: turn thumb wheel  to required position.

0 : front seats occupied

1 : all seats occupied

2 : all seats occupied and load compartment laden

3 : driver's seat occupied and load compartment laden

## Headlights when driving abroad

When driving in countries where traffic drives on the opposite side of the road, the headlights do not have to be adjusted.

## Daytime running lights

Daytime running lights increase visibility of the vehicle during daylight.

They are switched on automatically when the engine is running.

The system switches between daytime running lights and low beam automatically, depending on the lighting conditions.

## Hazard warning flashers

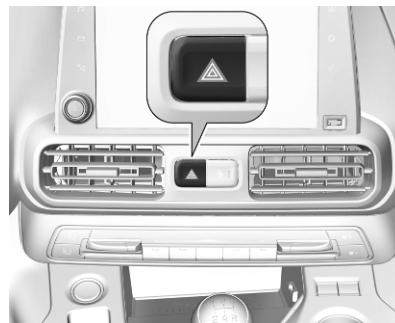

Hazard warning flashers are switched on automatically in the following situations:

- Braking in an emergency (depending on the force of deceleration).
- In the event of an accident.

They are switched off the first time you accelerate or if you press .

## Turn lights

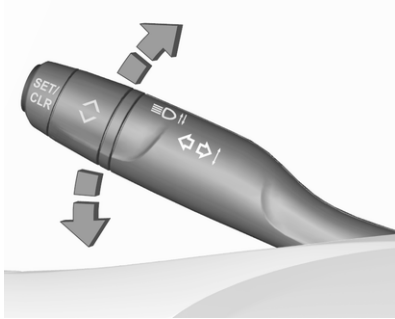

up : right turn lights  
down : left turn lights

A resistance point can be felt when moving the indicator lever.

Constant flashing is activated when the indicator lever is being moved beyond the resistance point. It is deactivated when the steering wheel is moved in the opposite direction or indicator lever is manually moved back to its neutral position.

Activate temporary flashing by holding the indicator lever just before the resistance point. Turn lights will flash until indicator lever is being released.

To activate three flashes, tap the indicator lever briefly without passing the resistance point.

If you forget to cancel the turn lights for more than twenty seconds, the volume of the audible signal will increase if the speed is above 40 mph.

## Front fog lights



Operated by pressing **F**.

Light switch in position **AUTO**: switching on front fog lights will switch headlights on automatically.

## Rear fog light



Operated by pressing **F**.

Light switch in position **AUTO**: switching on rear fog light will switch headlights on automatically.

Light switch in position **D**: rear fog light can only be switched on with front fog lights.

The vehicle rear fog light is deactivated when towing a trailer or a plug is connected with the socket, e.g. when a bicycle carrier is used.

## Parking lights

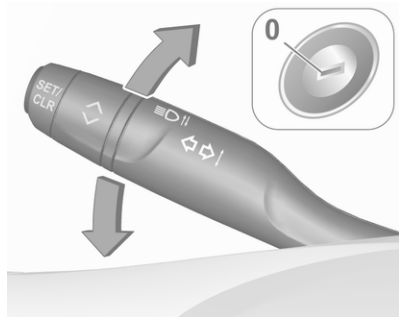

When the vehicle is parked, the parking lights on one side can be activated:

1. Switch off ignition.
2. Move indicator lever all the way up (right parking lights) or down (left parking lights).

Confirmed by a signal and the corresponding turn lights control indicator.

## Reversing lights

The reversing light comes on when the ignition is on and reverse gear is selected.

## Misted light covers

The inside of the light housing may mist up briefly in poor, wet and cold weather conditions, in heavy rain or after washing. The mist disappears quickly by itself; to help switch on the headlights.

## Interior lighting

### Instrument panel illumination control



Brightness of the following lights can be adjusted when the exterior lights are on:

- instrument panel illumination
- Info Display
- illuminated switches and operation elements

Turn thumb wheel  and hold until the desired brightness is obtained.



## Interior lights

During entry and exit of the vehicle, the front and rear courtesy lights automatically switch on and then off after a delay.

### Notice

In the event of an accident with airbag deployment the courtesy lights are turned on automatically.

## Front and rear courtesy light



Operate rocker switch:

 : automatic switching on and off

press  : on

press  : off

## Reading lights





Operated by pressing  and  in the courtesy lights.



Illustration shows rear courtesy lights.

## Sunvisor lights

Illuminates when the cover is opened.

## Lighting features

### Centre console lighting

A spotlight integrated in the overhead console illuminates the centre console when headlights are switched off.

The intensity can be adjusted in the vehicle personalisation ↻ 115.

### Entry lighting

#### Welcome lighting

Some or all of the following lights are switched on for a short time by unlocking the vehicle with the radio remote control:

- headlights
- tail lights
- interior lights

The number of activated lights depends on the surrounding light conditions.

The lighting switches off immediately when the ignition is switched on.

Starting off ↻ 17.

This function can be activated or deactivated in the vehicle personalisation ↻ 115.

The following lights will additionally switch on when the driver's door is opened:

- illumination of some switches
- Driver Information Centre

### Exit lighting

The following lights are switched on if the key is removed from the ignition switch:

- interior lights
- instrument panel light

They will switch off automatically after a delay. This function works only in the dark.

### Path lighting

Headlights, tail lights and number plate lights illuminate the surrounding area for an adjustable time after leaving the vehicle.

### Activating

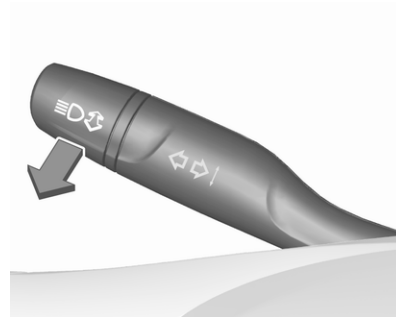

1. Switch off the ignition.
2. Open the driver's door.
3. Pull the indicator lever.
4. Close the driver's door.

If the driver's door is not closed, the lights switch off after two minutes.

Exit lighting is switched off immediately if the indicator lever is pulled while the driver's door is open.

This function can be activated or deactivated in the vehicle personalisation ↻ 115.

Info Display ↻ 110.

## Vehicle locator lighting

This function allows you to locate your vehicle, e.g., in weak lighting conditions using the remote control. The headlights come on and the turn lights flash for 10 seconds.

Press  on the remote control.

The vehicle must be locked more than 5 seconds.

## Peripheral lighting

Peripheral lighting allows you to switch on the position lights, low beam and number plate lighting using the remote control.

Press  on the remote control to switch on peripheral lighting.

Press  a second time to switch off peripheral lighting.

## Battery discharge protection

To prevent discharge of the vehicle battery when the ignition is switched off, some interior lights are switched off automatically after some time.

## Climate control







<b>Climate control systems</b> .....	<b>130</b>
Heating and ventilation system	130
Air conditioning system .....	131
Electronic climate control system .....	134
Parking heater .....	138
<b>Air vents</b> .....	<b>140</b>
Adjustable air vents .....	140
Fixed air vents .....	141
<b>Maintenance</b> .....	<b>141</b>
Air intake .....	141
Air conditioning regular operation .....	141
Service .....	141

## Climate control systems

### Heating and ventilation system



Controls for:

- temperature °
- air distribution ,  and 
- fan speed 
- air recirculation 
- heated rear window and exterior mirrors 
- heated seats 

Heated rear window  ⇨ 42.

Heated exterior mirrors  ⇨ 38.

Heated seats  ⇨ 49.

### Temperature

Adjust the temperature by turning  to the desired temperature.

HI : warm

LO : cold

Heating will not be fully effective until the engine has reached normal operating temperature.

### Air distribution

 : to windscreen and front door windows

 : to head area via adjustable air vents

 : to foot well and windscreen

All combinations are possible.

### Fan speed





Adjust the air flow by turning  to the desired speed.

clockwise : increase  
 anticlockwise : decrease

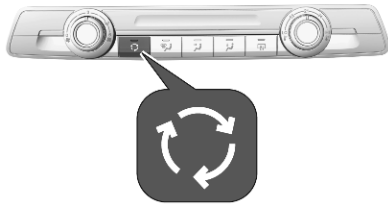
### Air recirculation system



Press  to activate air recirculation mode. The LED in the button illuminates to indicate activation.

Press  again to deactivate air recirculation mode.

#### Warning





The exchange of fresh air is reduced in air recirculation mode. In operation without cooling the air humidity increases, so the

windows may mist up from inside. The quality of the passenger compartment air deteriorates, which may cause the vehicle occupants to feel drowsy.

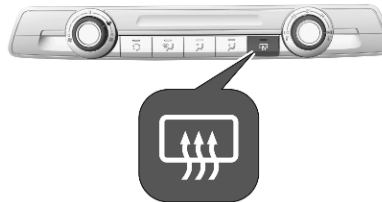
In warm and very humid ambient air conditions, the windscreen may mist up from outside when cold air is directed towards it. If windscreen mists up from outside, activate windscreen wiper and deactivate .

### Demisting and defrosting



- Press : the air distribution is directed towards the windscreen.
- Set temperature controller  to warmest level.
- Set fan speed  to highest level.
- Switch on heated rear window .
- Open side air vents as required and direct them towards the door windows.

Heated rear window, windscreen and exterior mirrors  42.



Heated seats  49.

### Air conditioning system



Controls for:

- temperature 
- air distribution ,  and 
- fan speed 

- cooling **A/C**
- air recirculation 
- heated rear window and exterior mirrors 

Heated rear window  ⇨ 42.

Heated exterior mirrors  ⇨ 38.

### Temperature

Adjust the temperature by turning  to the desired temperature.

HI : warm

LO : cold

Heating will not be fully effective until the engine has reached normal operating temperature.

### Air distribution

 : to windscreen and front door windows

 : to head area via adjustable air vents

 : to foot well

All combinations are possible.

### Fan speed

Adjust the air flow by turning  to the desired speed.

clockwise : increase

anticlockwise : decrease

### Cooling **A/C**

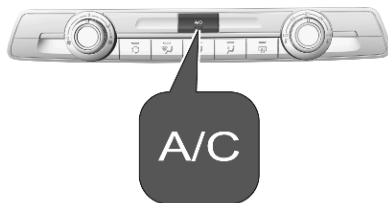

Press **A/C** to switch on cooling. The LED in the button illuminates to indicate activation. Cooling is only functional when the engine is running and fan is switched on.

Press **A/C** again to switch off cooling.

The air conditioning system cools and dehumidifies (dries) as soon as the outside temperature is slightly above

the freezing point. Therefore, condensation may form and drip from under the vehicle.

If no cooling or drying is required, switch off the cooling system for fuel saving reasons.

Activated cooling may inhibit Autostops. Stop-start system ⇨ 147.

### Air recirculation system

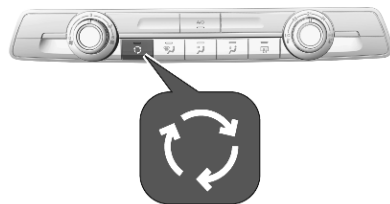

Press  to activate air recirculation mode. The LED in the button illuminates to indicate activation.

Press  again to deactivate air recirculation mode.

### ⚠ Warning



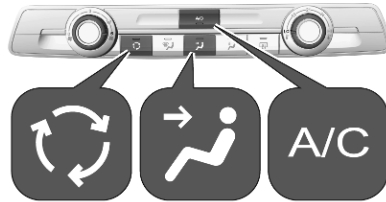

The exchange of fresh air is reduced in air recirculation mode. In operation without cooling the air humidity increases, so the windows may mist up from inside. The quality of the passenger compartment air deteriorates, which may cause the vehicle occupants to feel drowsy.

In warm and very humid ambient air conditions, the windscreen may mist up from outside when cold air is directed towards it. If windscreen mists up from outside, activate windscreen wiper and deactivate .

### Maximum cooling



Briefly open the windows so that hot air can disperse quickly.



- Switch on cooling **A/C**.
- Press  for air recirculation system on.
- Press  for air distribution.
- Set temperature control  to coldest level.
- Set fan speed  to highest level.
- Open all vents.

Heated rear window, windscreen and exterior mirrors    42.

Heated seats  49.

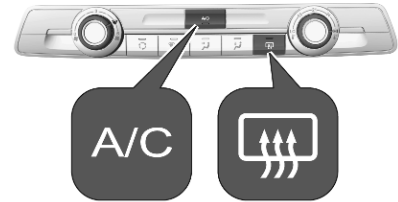
### Demisting and defrosting the windows



- Set fan speed  to highest level.
- Set temperature controller  to warmest level.
- Switch on cooling **A/C**, if required.
- Switch on heated rear window .
- Open side air vents as required and direct them towards the door windows.

**Notice**

If the settings for demisting and defrosting are selected, an Autostop may be inhibited.

If the settings for demisting and defrosting are selected while the engine is in an Autostop, the engine will restart automatically. Stop-start system ↗ 147.

Stop-start system ↗ 147.



**Electronic climate control system**

The dual zone climate control allows different temperatures for driver side and front passenger side.





In automatic mode, temperature, fan speed and air distribution are regulated automatically.



Controls for:

- manual air recirculation 
- air distribution 
- rocker switch for adjusting the temperature on driver side and front passenger side



- demisting and defrosting 
- cooling **A/C**
- automatic mode **AUTO**
- dual zone temperature synchronisation **MONO**
- heated rear window and exterior mirrors 
- fan speed  +  -

Heated rear window  ↗ 42.

Heated exterior mirrors  ↗ 38.

Activated functions are indicated by the LED in the respective control.

The electronic climate control system is only fully operational when the engine is running.

Make sure the sun sensor used by the electronic climate control system is not covered ↗ 10.

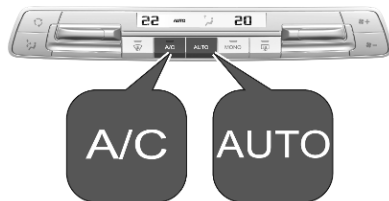
**Automatic mode AUTO**

Basic setting for maximum comfort:

- Press **AUTO**, the air distribution and fan speed are regulated automatically.
- Open all air vents to allow optimised air distribution in automatic mode.



- Air conditioning must be activated for optimal cooling and demisting. Press **A/C** to switch on air conditioning. The LED in the button indicates activation.
- Set the preselected temperatures for driver and front passenger using the left and right rotary ring. Recommended temperature is 22 °C.

Press successively **AUTO** to select the desired automatic settings:



- **Soft Auto** for a soft and silent air distribution.
- **Auto** for thermal comfort and silent air distribution.
- **Auto Fast** for a dynamic and efficient air distribution.

### Manual settings

Climate control system settings can be changed by activating the following functions:

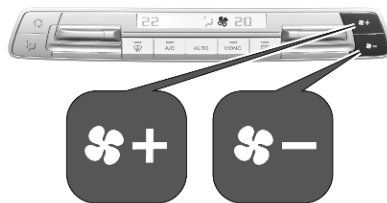
#### Fan speed + -





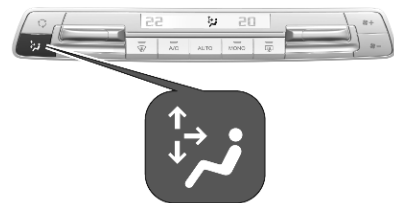

Press  + to increase or  - to decrease the air flow.

To return to automatic mode, press **AUTO**.

#### Air distribution



Press  successively until the desired direction of the air distribution is displayed:

-  : to windscreen and front door windows
-  : to head area and rear seats via adjustable air vents
-  : to front and rear foot well
-  : to windscreen and front door windows, to head area and rear seats via adjustable air vents, to front and rear foot well

Combinations of different air distribution options can be selected by pressing  successively.

To return to automatic air distribution, press **AUTO**.

### Temperature preselection



Set the preselected temperatures separately for the driver and the front passenger to the desired value using the left and right switch for adjusting the temperature.

Recommended temperature is 22 °C. Temperature is indicated in the display beside the switches for adjusting the temperature.

If the minimum temperature **Lo** is set, the climate control system runs at maximum cooling, if cooling **A/C** is switched on.

If the maximum temperature **Hi** is set, the climate control system runs at maximum heating.

### Notice

If **A/C** is switched on, reducing the set cabin temperature can cause the engine to restart from an Autostop or inhibit an Autostop.

Stop-start system ⇨ 147.

### Dual zone temperature synchronisation MONO

Press **MONO** to link passenger side temperature setting to the driver side / to remove the linking of the passenger side temperature setting to the driver side. The passenger side temperature setting is linked to the driver side if the LED in the button **MONO** is not illuminated.

### Air conditioning A/C

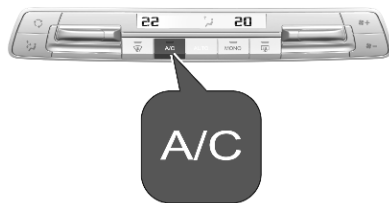

Press **A/C** to switch on cooling. Cooling is only functional when the engine is running and climate control fan is switched on.



Press **A/C** again to switch off cooling.

The air conditioning system cools and dehumidifies (dries) when outside temperature is above a specific level. Therefore condensation may form and drip from under the vehicle.

If no cooling or drying is required, switch off the cooling system for fuel saving reasons.

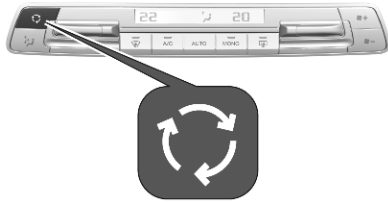
## Manual air recirculation



Press  to activate the air recirculation mode.  is shown in the display to indicate activation. Press  again to deactivate recirculation mode.

### Warning

The exchange of fresh air is reduced in air recirculation mode. In operation without cooling, the air humidity increases, so the windows may mist up from inside. The quality of the passenger



compartment air deteriorates, which may cause the occupants to feel drowsy.

In warm and very humid ambient air conditions, the windscreen may mist up from outside, when cold air is directed towards it. If windscreen mists up from outside, activate windscreen wiper and deactivate .

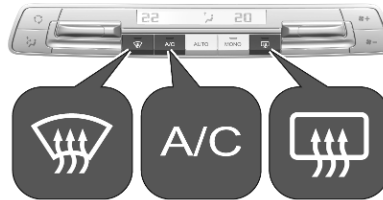

## Demisting and defrosting the windows





- Press . The LED in the button illuminates to indicate activation.

- Air conditioning and automatic mode are automatically switched on. The LED in the button **A/C** illuminates, **AUTO** is shown in the display.
- Temperature and air distribution are set automatically and the fan runs at high speed.
- Switch on heated rear window .
- Switch on heated windscreen .
- To return to previous mode, press  again.

### Notice

If  is pressed while the engine is running, an Autostop will be inhibited until  is pressed again.

If  is pressed while the engine is in an Autostop, the engine will restart automatically.

Stop-start system  147.

### Deactivation of electronic climate control system



Press **☼** – subsequently until the electronic climate control system is deactivated.

### Parking heater

The parking heater allows to heat the vehicle's interior and to ventilate the vehicle's interior with ambient air.

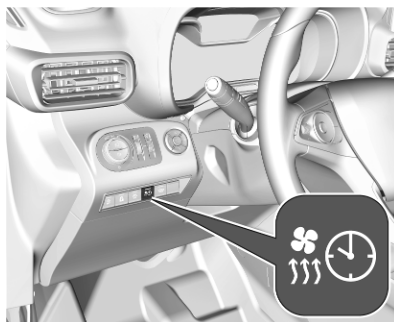

The operating status of the parking heater is shown by an indicator with a LED.

- LED illuminates: A timer has been set.
- LED flashes: The system is operating.

The LED is extinguished at the end of the heating operation or when the parking heater is stopped using the remote control.

The parking heater can be programmed using the Graphic Info Display / Colour Info Display.

Additionally, the parking heater can be switched on and off using a remote control.

### Graphic Info Display

Press **MENU** to open the menu page.

Press **Heating** or **Ventilation**.

Press **<<** or **>>** to select the desired timer. Confirm with **OK**.

Set the required time of the timer: Press **△** or **▽** to set the desired value. Confirm with **OK**.

To set the timer, press **<<** or **>>** to select **OK** on the display. Confirm with **OK**.

### Colour Info Display

Press **☼**.

Press **Car Apps**.

Press **Temperature conditioning**.

Close pop-up messages with **←**.



### Programme the parking heater

Press **Settings**.

Select **Heating** or **Ventilation** and then press **☼**.

Two starting times for the operation of the parking heater can be programmed.

Press **Time 1** or **Time 2** to select the desired timer and then press .

Define the time by pressing  **Time 1** for the timer one or  **Time 2** for the timer two.

Press  to save the settings.

### Activate / deactivate the programming

Press **State**.

Activate or deactivate **Temperature conditioning** by pressing **ON** or **OFF** and then press .

Only one starting time can be activated.

### Parking heater via remote control

The parking heater can be switched on or off using a remote control.



Press . The parking heater is activated.

Press **OFF**. The parking heater is deactivated.

### Replacing the battery in the remote control

If the indicator light of the remote control turns yellow, the charging status of the battery is weak. If the indicator light does not illuminate anymore, the battery is discharged and has to be replaced.

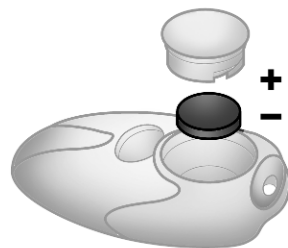

1. Remove the cap of the remote control by unscrewing it with a coin and remove the battery
2. Replace battery with a battery of the same type. Pay attention to the installation position.
3. Screw the cap in its place .

## Air vents

### Adjustable air vents

#### Air vents in the instrument panel

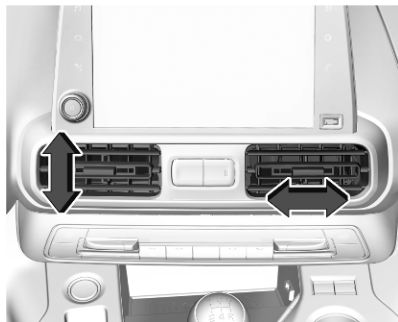

Direct the flow of air by tilting and swivelling the slats.

To close the vent, swivel the slats inwards.

#### Outer air vents in the instrument panel

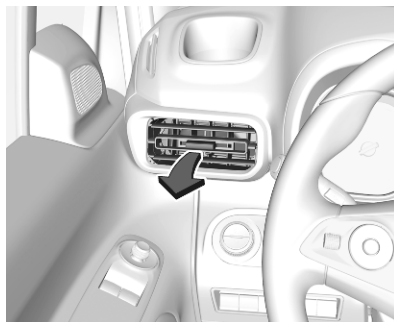

Direct the flow of air by tilting and swivelling the slats.

To close the vent, swivel the slats outwards.

At least two air vents must be open while cooling is on.

#### Warning

Do not attach any objects to the slats of the air vents. Risk of damage and injury in case of an accident.

#### Rear air vents in the centre console

To activate the distribution of climatized / heated air via the rear air vents, press .

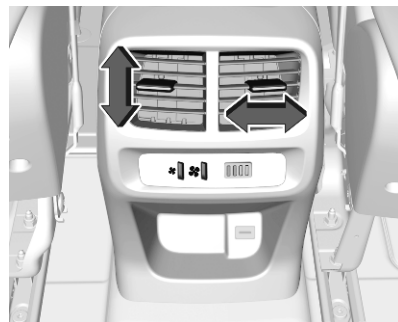

Direct the flow of air by tilting and swivelling the slats.

Adjust the air flow to select the desired speed.

 : increase air flow

 : decrease air flow

## Fixed air vents

Additional air vents are located beneath the windscreen, the door windows and in the foot wells.

## Maintenance

### Air intake

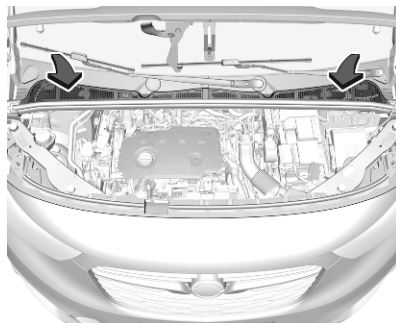

The air intake in front of the windscreen in the engine compartment must be kept clear to allow air intake. Remove any leaves, dirt or snow.

## Air conditioning regular operation

In order to ensure continuously efficient performance, cooling must be operated for a few minutes once a month, irrespective of the weather and time of year. Operation with cooling is not possible when the outside temperature is too low.

## Service

For optimal cooling performance, it is recommended to annually check the climate control system, starting three years after initial vehicle registration, including:

- functionality and pressure test
- heating functionality
- leakage check
- check of drive belts
- cleaning of condenser and evaporator drainage
- performance check

# Driving and operating

<b>Driving hints</b> .....	<b>143</b>
Control of the vehicle .....	143
Steering .....	143
<b>Starting and operating</b> .....	<b>143</b>
New vehicle running-in .....	143
Ignition switch positions .....	143
Power button .....	144
Starting the engine .....	145
Overrun cut-off .....	147
Stop-start system .....	147
Parking .....	150
<b>Engine exhaust</b> .....	<b>151</b>
Exhaust filter .....	151
Catalytic converter .....	151
AdBlue .....	152
<b>Automatic transmission</b> .....	<b>155</b>
Transmission display .....	155
Gear selection .....	155
Manual mode .....	156
Electronic driving programmes .....	157
Fault .....	157
Eco mode .....	157
<b>Manual transmission</b> .....	<b>158</b>

<b>Brakes</b> .....	<b>159</b>
Antilock brake system .....	159
Parking brake .....	160
Brake assist .....	162
Hill start assist .....	162
<b>Ride control systems</b> .....	<b>163</b>
Electronic Stability Control and Traction Control system .....	163
Descent control system .....	164
Selective ride control .....	165
<b>Driver assistance systems</b> .....	<b>167</b>
Cruise control .....	167
Speed limiter .....	169
Adaptive cruise control .....	171
Forward collision alert .....	178
Active emergency braking .....	179
Front pedestrian protection .....	182
Parking assist .....	183
Advanced parking assist .....	187
Side blind spot alert .....	191
Passenger side camera .....	192
Panoramic view system .....	193
Rear view camera .....	196
Lane keep assist .....	198
Driver alert .....	201
<b>Fuel</b> .....	<b>202</b>
Fuel for petrol engines .....	202
Fuel for diesel engines .....	203
Refuelling .....	204

<b>Trailer hitch</b> .....	<b>206</b>
General information .....	206
Driving characteristics and towing tips .....	206
Trailer towing .....	206
Towing equipment .....	207
Trailer stability assist .....	210



## Driving hints

### Control of the vehicle

#### Never coast with engine not running

Many systems will not function in this situation (e.g. brake servo unit, power steering). Driving in this manner is a danger to yourself and others.

All systems function during an Autostop.

Stop-start system ⇨ 147.

#### Pedals

To ensure the pedal travel is uninhibited, there must be no mats in the area of the pedals.

Use only floor mats, which fit properly and are fixed by the retainers on the driver side.

## Steering

If power steering assist is lost because the engine stops or due to a system malfunction, the vehicle can be steered but may require increased effort.

## Starting and operating

### New vehicle running-in

Do not brake unnecessarily hard for the first few journeys.

During the first drive, smoke may occur because of wax and engine oil evaporating off the exhaust system. Park the vehicle in the open for a while after the first drive and avoid inhaling the fumes.

During the running-in period, fuel and engine oil consumption may be higher.

Additionally, the cleaning process of the exhaust filter may take place more often.

Exhaust filter ⇨ 151.

### Ignition switch positions

Turn key:

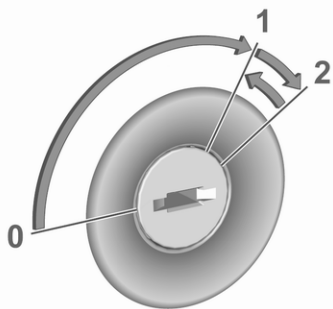

- 0 : ignition off: some functions remain active until key is removed or driver's door is opened, provided the ignition was on previously
- 1 : ignition on power mode: ignition is on, diesel engine is preheating, control indicators illuminate and most electrical functions are operable
- 2 : engine start: release key after engine has been started

### Steering wheel lock

Remove key from ignition switch and turn steering wheel until it engages.

### **⚠ Danger**

Never remove the key from ignition switch during driving as this will cause steering wheel lock.

### Power button

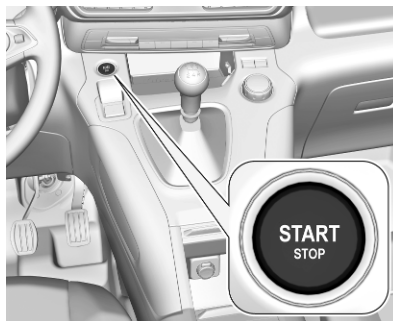

The electronic key must be inside the vehicle.

### Engine start

Operate the clutch pedal (manual transmission), the brake pedal and press **Start/Stop**.

### Ignition on power mode without starting the engine

Press **Start/Stop** without operating clutch or brake pedal. Control indicators illuminate and most electrical functions are operable.

### Engine and ignition off

Press **Start/Stop** briefly in each mode or when engine is running and vehicle is stationary. Some functions remain active until driver's door is opened, provided the ignition was on previously.

### Emergency shut off during driving

Press **Start/Stop** for about three seconds ↻ 145. Steering wheel locks as soon as vehicle is stationary.

### Steering wheel lock

The steering wheel lock activates automatically when:

- The vehicle is stationary.
- The ignition has been switched off.

To release steering wheel lock, open and close driver's door and switch the ignition on power mode or start the engine directly.

### ⚠ Warning

If the vehicle battery is discharged, the vehicle must not be towed, tow-started or jump-started as the steering wheel lock cannot be disengaged.

### Operation on vehicles with electronic key system in case of failure

If either the electronic key fails or the battery of the electronic key is weak, a message may be displayed in the Driver Information Centre.

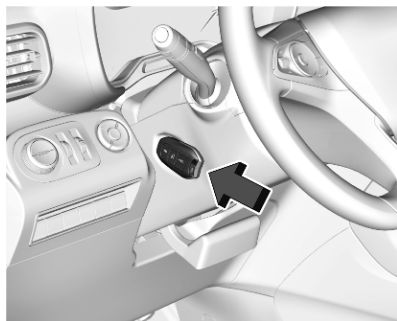

Hold the electronic key with buttons outside at the marking on the steering column cover as shown in the illustration.

Operate the clutch pedal (manual transmission), the brake pedal and press **Start/Stop**.

This option is intended for emergencies only. Replace the electronic key battery as soon as possible ⇨ 22.

For unlocking or locking the doors, see fault in radio remote control unit or electronic key system ⇨ 24.

## Starting the engine

### Vehicles with ignition switch

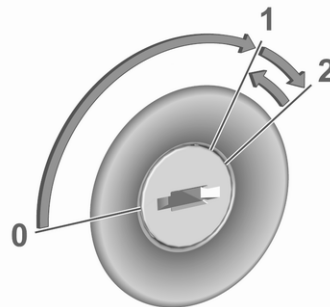

Turn key to position 1 to release the steering wheel lock.

Manual transmission: operate clutch and brake pedal.

Automatic transmission: operate brake pedal and move selector lever to **P** or **N**.

Do not operate accelerator pedal.

Diesel engines: wait until control indicator  extinguishes.

Turn key briefly to position 2 and release after engine has been started.

Manual transmission: during an Autostop, the engine can be started by depressing the clutch pedal ↻ 147.

Automatic transmission: during an Autostop, the engine can be started by releasing the brake pedal ↻ 147.

### Vehicles with power button

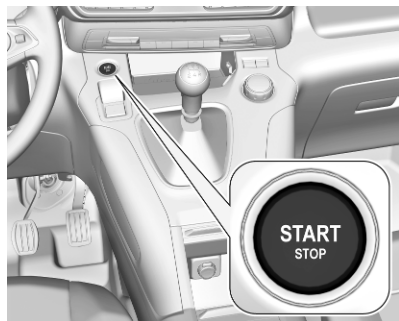

- Manual transmission: operate clutch and brake pedal.
- Automatic transmission: operate brake pedal and move selector lever to **P** or **N**.
- Do not operate accelerator pedal.
- Press **Start/Stop** button.
- Release button after starting procedure begins. Diesel engine starts after control indicator  for preheating.
- Before restarting or to switch off the engine when vehicle is stationary, press **Start/Stop** once more briefly.

To start the engine during an Autostop:

- Manual transmission: during an Autostop, the engine can be started by depressing the clutch pedal ↻ 147.
- Automatic transmission: during an Autostop, the engine can be started by releasing the brake pedal ↻ 147.

### Emergency shut off during driving

If the engine needs to be switched off during driving in case of emergency, press **Start/Stop** for five seconds.

#### Danger

Switching off the engine during driving may cause loss of power support for brake and steering systems. Assistance systems and airbag systems are disabled. Lighting and brake lights will extinguish. Therefore power down the engine and ignition while driving only when required in case of emergency.

## Starting the vehicle at low temperatures

Starting the engine without additional heaters is possible down to -25 °C for diesel engines and -30 °C for petrol engines. Required is an engine oil with the correct viscosity, the correct fuel, performed services and a sufficiently charged vehicle battery. With temperatures below -30 °C the automatic transmission requires a warming phase of approx. five minutes. The selector lever must be in position **P**.

## Heating functionalities

### Notice

Individual heating functionalities, such as heated seats or heated steering wheel, may be temporarily unavailable in the event of electrical loading constraints. Functions will be resumed after some minutes.

## Turbo engine warm-up

Upon start-up, engine available torque may be limited for a short time, especially when the engine temperature is cold. The limitation is to allow the lubrication system to fully protect the engine.

## Overrun cut-off

The fuel supply is automatically cut off during overrun, i.e. when the vehicle is driven with a gear engaged but accelerator pedal is released.



Depending on driving conditions, the overrun cut-off may be deactivated.

## Stop-start system

The stop-start system helps to save fuel and to reduce the exhaust emissions. When conditions allow, it switches off the engine as soon as the vehicle is at a low speed or at a standstill, e.g. at a traffic light or in a traffic jam.

## Activation

The stop-start system is available as soon as the engine is started, the vehicle starts-off and the conditions as stated below in this section are fulfilled.

The system is ready to operate when the LED in the button  is not illuminated. To activate the system when the system is deactivated, press .

If the stop-start system is temporarily not available and the button  is pressed, the LED in the button flashes.

## Deactivation



Deactivate the stop-start system manually by pressing . The deactivation is indicated when the LED in the button illuminates.

## Autostop

### Vehicles with manual transmission

An Autostop can be activated at a standstill or at speed below 12 mph.

Activate an Autostop as follows:

- Depress the clutch pedal.
- Set the selector lever to neutral.
- Release the clutch pedal.

The engine will be switched off while the ignition stays on.

### Vehicles with automatic transmission

If the vehicle is at a standstill with depressed brake pedal, Autostop is activated automatically.

The engine will be switched off while the ignition stays on.

The stop-start system will be disabled on inclines of 12% or more.

## Indication



An Autostop is indicated by control indicator .

During an Autostop, the heating and brake performance will be maintained.

### Conditions for an Autostop

The stop-start system checks if each of the following conditions is fulfilled.

- The stop-start system is not manually deactivated.
- The driver's door is closed or the driver's seat belt is fastened.
- The vehicle battery is sufficiently charged and in good condition.
- The engine is warmed up.
- The engine coolant temperature is not too high.
- The engine exhaust temperature is not too high, e.g. after driving with high engine load.
- The ambient temperature is not too low.
- The climate control system allows an Autostop.
- The brake vacuum is sufficient.
- The self-cleaning function of the exhaust filter is not active.
- The vehicle was driven at least at walking speed since the last Autostop.

Otherwise an Autostop will be inhibited.

**Notice**

The Autostop may be inhibited for several hours after a battery replacement or reconnection.

Certain settings of the climate control system may inhibit an Autostop.

Climate control ⇨ 131.

Immediately after higher speed driving an Autostop may be inhibited.

New vehicle running-in ⇨ 143.

**Vehicle battery discharge protection**

To ensure reliable engine restarts, several vehicle battery discharge protection features are implemented as part of the stop-start system.

**Power saving measures**

During an Autostop, several electrical features such as auxiliary electric heater or rear window heating are disabled or switched to a power saving mode. The fan speed of the climate control system is reduced to save power.

**Restart of the engine by the driver****Vehicles with manual transmission**

Depress the clutch pedal without depressing the brake pedal to restart the engine.

**Vehicles with automatic transmission**

The engine is restarted if

- the brake pedal is released while the selector lever is in position **D** or **M**
- or the brake pedal is released or the selector lever is in position **N** when the selector lever is moved to position **D** or **M**
- or the selector lever is moved to position **R**.

**Restart of the engine by the stop-start system**

The selector lever must be in neutral to enable an automatic restart.

If one of the following conditions occurs during an Autostop, the engine will be restarted automatically by the stop-start system:

- The stop-start system is manually deactivated.
- The driver's seat belt is unfastened and the driver's door is opened.
- The engine temperature is too low.
- The charging level of the vehicle battery is below a defined level.
- The brake vacuum is not sufficient.
- The vehicle is driven at least at walking speed.
- The climate control system requests an engine start.
- The air conditioning is manually switched on.

If an electrical accessory, e.g. a portable CD player, is connected to the power outlet, a brief power drop during the restart might be noticeable.

## Parking

### ⚠ Warning

- Do not park the vehicle on an easily ignitable surface. The high temperature of the exhaust system could ignite the surface.
- Always apply the parking brake.
- If the vehicle is on a level surface or uphill slope, engage first gear or set the selector lever to position **P**. On an uphill slope, turn the front wheels away from the kerb.  
If the vehicle is on a downhill slope, engage reverse gear or set the selector lever to position **P**. Turn the front wheels towards the kerb.
- Close the windows.
- Switch off the engine.
- Remove the ignition key from the ignition switch or switch off ignition on vehicles with power

button. Turn the steering wheel until the steering wheel lock is felt to engage.

- Lock the vehicle.
- Activate the anti-theft alarm system.
- The engine cooling fans may run after the engine has been switched off ↗ 213.

### Caution

After running at high engine speeds or with high engine loads, operate the engine briefly at a low load or run in neutral for approx. 30 seconds before switching off, in order to protect the turbocharger.

### Notice

In the event of an accident with airbag deployment, the engine is switched off automatically if the vehicle comes to a standstill within a certain time.

In countries with extremely low temperatures it may be necessary to park the vehicle without applied parking brake. Make sure to park the vehicle on a level surface.



## Engine exhaust

### Danger

Engine exhaust gases contain poisonous carbon monoxide, which is colourless and odourless and could be fatal if inhaled.



If exhaust gases enter the interior of the vehicle, open the windows. Have the cause of the fault rectified by a workshop.

Avoid driving with an open load compartment, otherwise exhaust gases could enter the vehicle.

## Exhaust filter

### Automatic cleaning process

The exhaust filter system filters soot particles out of the exhaust gases.



The start of saturation of the exhaust filter is indicated by the temporary illumination of  or , accompanied by a message in the Driver Information Centre.

As soon as the traffic conditions permit, regenerate the filter by driving at a vehicle speed of at least 40 mph until the control indicator extinguishes.

### Notice

On a new vehicle, the first exhaust filter regeneration operations may be accompanied by a burning smell, which is normal. Following prolonged operation of the vehicle at very low speed or at idle, water vapour can be emitted at the exhaust on acceleration. This does not affect the behaviour of the vehicle or the environment.

### Cleaning process not possible



If  or  stays on, accompanied by an audible signal and a message, this indicates that the exhaust filter additive level is too low.

The reservoir must be topped-up without delay. Seek the assistance of a workshop.

## Catalytic converter

The catalytic converter reduces the amount of harmful substances in the exhaust gases.

### Caution

Fuel grades other than those listed on pages  202,  260 could damage the catalytic converter or electronic components.

Unburnt petrol will overheat and damage the catalytic converter. Therefore avoid excessive use of the starter, running the fuel tank dry and starting the engine by pushing or towing.

In the event of misfiring, uneven engine running, a reduction in engine performance or other unusual problems, have the cause of the fault rectified by a workshop as soon as possible. In an emergency, driving can be continued for a short period, keeping vehicle speed and engine speed low.

## AdBlue

### General information

The selective catalytic reduction (BlueInjection) is a method to substantially reduce the nitrogen oxides in the exhaust emission. This is achieved by injecting a Diesel Exhaust Fluid (DEF) into the exhaust system. The ammonia released by the fluid reacts with nitrous gases (NO<sub>x</sub>) from the exhaust and turns it into nitrogen and water.

The designation of this fluid is AdBlue®. It is a non-toxic, non-flammable, colourless and odourless fluid which consists of 32% urea and 68% water.

#### Warning

Avoid contact of your eyes or skin with AdBlue.

In case of eye or skin contact, rinse off with water.

#### Caution

Avoid contact of the paintwork with AdBlue.

In case of contact, rinse off with water.

AdBlue freezes at a temperature of approx. -11 °C. As the vehicle is equipped with an AdBlue preheater, the emissions reduction at low temperatures is ensured. The AdBlue preheater works automatically.

#### Notice

Frozen and again liquefied AdBlue is usable without quality loss.

The typical AdBlue consumption is approx. 0.85 l per 600 miles, but can also be higher depending on driving behaviour (e.g. high load or towing).

#### Level warnings

Depending on the calculated range of AdBlue, different messages are displayed in the Driver Information Centre. The messages and the restrictions are a legal requirement.

1. The first possible warning is **Top up emissions additive: Starting prevented in 1500 mi.**

When switching on the ignition, this warning will show up once briefly with the calculated range. Additionally, control indicator  will illuminate and a chime will sound. Driving is possible without any restrictions.

2. The next warning level is entered with a range below 500 miles. The message with the current range will always be displayed when ignition is switched on. Additionally, control indicator  will illuminate and a chime will sound. Refill AdBlue before entering the next warning level. When driving, the chime sounds and the message is displayed every 60 miles until the additive tank has been topped-up.
3. The next warning level is entered with a range below 60 miles. The message with the current range will always be displayed when ignition is switched on.

Additionally, control indicator  will flash and a chime will sound. Refill AdBlue as soon as possible before the AdBlue tank is completely empty. Otherwise, a restart of the engine will not be possible.

When driving, the chime sounds and the message is displayed every 6 miles until the additive tank has been topped-up.

4. The last warning level is entered when the AdBlue tank is empty. Restart of the engine is not possible. The following warning message will be displayed:

**Top up emissions additive: Starting prevented**

Additionally, control indicator  will flash and a chime will sound.

Refill the tank to a level of at least 5 l of AdBlue, otherwise restarting of the engine is not possible.



**Notice**

For D16DT engines, different levels apply.

**High emission warnings**

In the event of a fault with the emissions control system, different messages are displayed in the Driver Information Centre. The messages and the restrictions are a legal requirement.



1. If a fault is detected for the first time, the warning **Emissions fault** is displayed.

Additionally, control indicators ,  and  will illuminate and a chime will sound. Driving is possible without any restrictions.

If it is a temporary fault, the alert disappears during the next journey, after self-diagnosis of the emissions control system.

2. If the fault is confirmed by the emission control system, the following message will be displayed:



**Emissions fault: Starting prevented in 650 miles.**

Additionally, control indicators ,  and  will illuminate and a chime will sound.

When driving, the message is displayed every 30 s while the fault persists.

3. If the last warning level is entered, the following warning message will be displayed:

**Emissions fault: Starting prevented**

Additionally, control indicators ,  and  will illuminate and a chime will sound.

Consult a workshop for assistance.

**Refilling AdBlue**

**Caution**

Only use AdBlue that complies with European standards DIN 70 070 and ISO 22241-1.

Do not use additives.

Do not dilute AdBlue.

Otherwise the selective catalytic reduction system could be damaged.

**Notice**

Whenever a filling pump with a nozzle for passenger cars is not available at a filling station, use only AdBlue bottles or canisters with a sealed refill adapter for refilling, to prevent splashback and overspill, and in order to ensure that the fumes from the tank are captured and do not emerge. AdBlue in bottles or canisters is available in many filling stations and can be purchased e.g. at Vauxhall dealers and other retail outlets.

Since AdBlue has a limited durability, check the date of expiry before refilling.

**Notice**

Refill the tank to a level of at least 5 l to ensure that the new AdBlue level is being detected.

In case AdBlue refill is not successfully detected:

1. Continuously drive the vehicle for 10 min making sure that vehicle speed is always higher than 12 mph.
2. If AdBlue refill is detected successfully, AdBlue supply-driven warnings or limitations will disappear.

If AdBlue refill is still not detected, seek the assistance of a workshop.

If AdBlue must be refilled at temperatures below -11 °C, the refilling of AdBlue may not be detected by the system. In this event, park the vehicle in a space with a higher ambient temperature until AdBlue is liquified.

**Notice**

When unscrewing the protective cap from the filler neck, ammonia fumes may emerge. Do not inhale as the fumes have a pungent smell. The fumes are not harmful by inhalation.

The AdBlue tank should be filled completely. This must be done if the warning message regarding prevention of an engine restart is already displayed.

The vehicle must be parked on a level surface.

The filler neck for AdBlue is located behind the fuel filler flap, which is located at left rear side of the vehicle.

If the vehicle is equipped with an electronic key system, the fuel filler flap can only be opened if the vehicle is unlocked.

1. Remove key from ignition switch.
2. Close all doors to avoid ammonia fumes entering the interior of the vehicle.
3. Release the fuel filler flap by pushing the flap ↗ 204.



4. Unscrew protective cap from the filler neck.
5. Open AdBlue canister.
6. Mount one end of the hose on the canister and screw the other end on the filler neck.
7. Lift the canister until it is empty, or until the flow from the canister has stopped. This can take up to five minutes.
8. Place the canister on the ground to empty the hose, wait 15 s.
9. Unscrew the hose from the filler neck.
10. Mount the protective cap and turn clockwise until it engages.

#### Notice

Dispose of AdBlue canister according to environmental requirements. Hose can be reused after flushing with clear water before AdBlue dries out.

## Automatic transmission

The automatic transmission permits automatic gearshifting (automatic mode) or manual gearshifting (manual mode).

Manual shifting is possible in manual mode by pressing **M** next to the selector wheel and shifting with the paddles **+** and **-** on the steering wheel  
 ⇨ 156.

## Transmission display

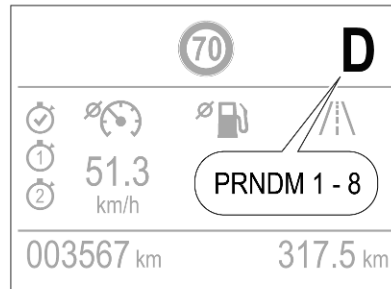

The mode or selected gear is shown in the Driver Information Centre.

In automatic mode, the driving programme is indicated by **D**.

In manual mode, **M** and the number of the selected gear is indicated.

**R** indicates reverse gear.

**N** indicates neutral position.

**P** indicates park position.

## Gear selection

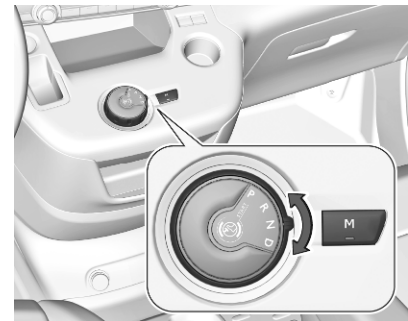

Turn the gear selector.

- P** : park position, front wheels are locked, engage only when the vehicle is stationary and the parking brake is applied
- R** : reverse gear, engage only when the vehicle is stationary
- N** : neutral
- D** : automatic mode
- M** : manual mode

The gear selector is locked in **P** and can only be moved when the ignition is on and the brake pedal is applied.

The engine can only be started with the gear selector in position **P** or **N**. When position **N** is selected, press the brake pedal or apply the parking brake before starting.

Do not accelerate while engaging a gear. Never depress the accelerator pedal and brake pedal at the same time.

When a gear is engaged, the vehicle slowly begins to creep when the brake is released.

### Engine braking

To utilise the engine braking effect, select a lower gear when driving downhill.

### Rocking the vehicle

Rocking the vehicle is only permissible if the vehicle is stuck in sand, mud or snow. Move the gear selector between **D** and **R** in a repeat pattern. Do not race the engine and avoid sudden acceleration.

### Parking

Apply the parking brake and select **P**.

### Manual mode

Manual mode **M** can be activated from position **D** in each driving situation and speed.

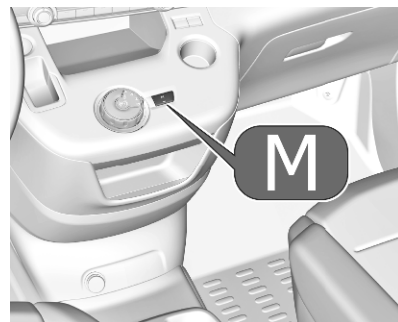

Press button **M**.

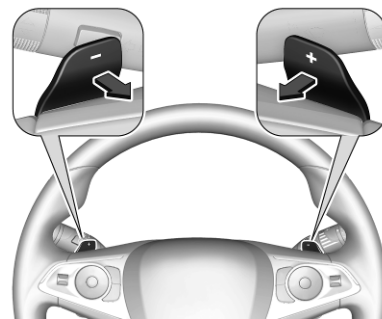

Pull steering wheel paddles to select gears manually.

Pull right paddle + to shift to a higher gear.

Pull left paddle - to shift to a lower gear.

Multiple pulls allow gears to be skipped.

The selected gear is indicated in the instrument cluster.

If a higher gear is selected when vehicle speed is too low, or a lower gear when vehicle speed is too high, the shift is not executed. This can cause a message in the Driver Information Centre.

In manual mode, no automatic shifting to a higher gear takes place at high engine revolutions.

### Gear shift indication

The symbol ▲ or ▼ with a number beside it is indicated when gearshifting is recommended for fuel saving reasons.

Shift indication appears only in manual mode.

## Electronic driving programmes

- Following a cold start, the operating temperature programme increases engine speed to quickly bring the catalytic converter to the required temperature.
- Special programmes automatically adapt the shifting points when driving up inclines or down hills.
- In snowy or icy conditions or on other slippery surfaces, the electronic transmission control enables the driver to select manually first, second or third gear for starting off.

### Kickdown

Pressing down the accelerator pedal beyond the kickdown detent will lead to maximum acceleration independent of selected driving mode. The transmission shifts to a lower gear depending on engine speed.

## Fault

In the event of a fault a message is displayed in the Driver Information Centre.

Vehicle messages ⇨ 114.

Electronic transmission control enables only third gear. The transmission no longer shifts automatically.

Do not drive faster than 62 mph.

Have the cause of the fault remedied by a workshop.

## Eco mode



This mode adjusts the settings of the systems for a more economic fuel consumption, e.g. by optimising the automatic transmission shift points and adapting the sensitivity of the accelerator pedal.

## Manual transmission

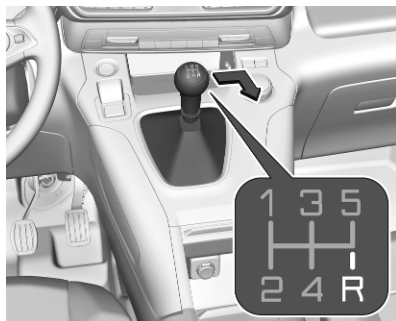

To engage reverse on 5-speed transmission, depress the clutch pedal and move the selector lever to the right and rear.

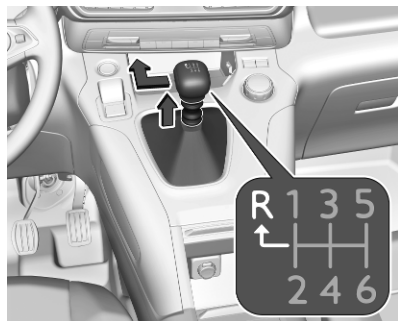

To engage reverse on 6-speed transmission, depress the clutch pedal, pull the ring under the selector lever and move the selector lever quite to the left and front.

If the gear does not engage, set the selector lever to neutral, release the clutch pedal and depress again. Then repeat gear selection.

Do not slip the clutch unnecessarily.

When operating, depress the clutch pedal completely. Do not use the pedal as a foot rest.



When clutch slip is detected for a specific time, the engine power will be reduced. A warning is displayed in the Driver Information Centre. Release the clutch.

### Caution

It is not advisable to drive with the hand resting on the selector lever.

Gear shift indication ⇨ 104.

Stop-start system ⇨ 147.

## Brakes

The brake system comprises two independent brake circuits.

If a brake circuit fails, the vehicle can still be braked using the other brake circuit. However, braking effect is achieved only when the brake pedal is depressed firmly. Considerably more force is needed for this. The braking distance is extended. Seek the assistance of a workshop before continuing the journey.

When the engine is not running, the support of the brake servo unit disappears once the brake pedal has been depressed once or twice. Braking effect is not reduced, but braking requires significantly greater force. It is especially important to bear this in mind when being towed.

Control indicator (P) ⇨ 103.

## Antilock brake system

Antilock brake system (ABS) prevents the wheels from locking.

ABS starts to regulate brake pressure as soon as a wheel shows a tendency to lock. The vehicle remains steerable, even during hard braking.

ABS control is made apparent through a pulse in the brake pedal and the noise of the regulation process.

For optimum braking, keep the brake pedal fully depressed throughout the braking process, despite the fact that the pedal is pulsating. Do not reduce the pressure on the pedal.

When braking in an emergency, the hazard warning flashers are switched on automatically depending on the force of deceleration. They are switched off automatically the first time you accelerate.

After starting off, the system performs a self-test which may be audible.



Control indicator (ABS) ⇨ 104.

## Fault

### ⚠ Warning

If there is a fault in the ABS, the wheels may be liable to lock due to braking that is heavier than normal. The advantages of ABS are no longer available. During hard braking, the vehicle can no longer be steered and may swerve.

Have the cause of the fault remedied by a workshop.

## Parking brake

### ⚠ Warning

Before leaving the vehicle, check parking brake status. Control indicator (P) illuminates constantly when electric parking brake is applied.

## Manual parking brake

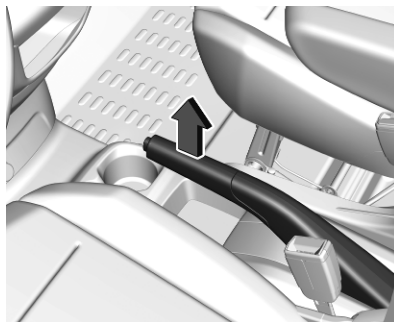

### ⚠ Warning

Always apply parking brake firmly without operating the release button, and apply as firmly as possible on a downhill or uphill slope.

To release the parking brake, pull the lever up slightly, press the release button and fully lower the lever.

To reduce the operating forces of the parking brake, depress the foot brake at the same time.

Control indicator (P) ⇨ 103.

## Electric parking brake

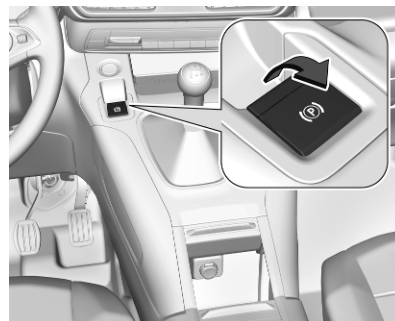

## Applying when vehicle is stationary

### ⚠ Warning

Pull switch (P) for a minimum of one second until control indicator (P) illuminates constantly and electric parking brake is applied

⇨ 103. The electric parking brake operates automatically with adequate force.

Before leaving the vehicle, check the electric parking brake status. Control indicator (P) ⇨ 103.

The electric parking brake can always be activated, even if the ignition is off.

Do not operate electric parking brake system too often without engine running as this will discharge the vehicle battery.

### Releasing

Switch on ignition. Keep foot brake pedal depressed and then push switch (P).

### Drive away function

Depressing the clutch pedal and then slightly releasing the clutch pedal and slightly depressing the accelerator pedal releases the electric parking brake automatically. This is only possible if the automatic operation of the electric parking brake is activated. It is not possible when switch (P) is pulled at the same time.

### Braking when vehicle is moving

When the vehicle is moving and the switch (P) is kept pulled, the electric parking brake system will decelerate the vehicle. As soon as the switch (P) is released, braking will be stopped.

The antilock brake system and the Electronic Stability Control stabilise the vehicle while the switch (P) is kept pulled. If an error of the electric parking brake occurs, a warning message is displayed in the driver information centre. If the antilock brake system and the Electronic Stability Control fail, one or both indicators (ABS) and  illuminate in the instrument cluster. In this case, stability can only be provided by repeatedly pulling and pushing the switch (P) until the vehicle is immobilised.

### Automatic operation

Automatic operation includes automatic application and automatic release of the electric parking brake.

The electric parking brake can also be applied or released manually by using the switch (P).

Automatic application:

- The electric parking brake is automatically applied when the vehicle is stationary and the ignition is switched off.
- (P) illuminates in the instrument cluster and a display message pops up to confirm the application.

Automatic release:

- Parking brake releases automatically after moving off.
- (P) extinguishes in the instrument cluster and a display message pops up to confirm the release.

If the vehicle is equipped with an automatic transmission and the brake is not released automatically, make sure the front doors are correctly closed.

### Deactivation of automatic operation

1. Start the engine.
2. If the parking brake is released, apply the parking brake pulling the switch (P).
3. Take your foot off the brake pedal.
4. Press the switch (P) for at least 10 s and maximum 15 s.
5. Release the switch (P).
6. Press and hold the brake pedal.
7. Pull the switch (P) for 2 s.

The deactivation of the automatic operation of the electric parking brake is confirmed by  illuminating in the instrument cluster ⇨ 103. The electric parking brake can only be applied and released manually.

To reactivate the automatic operation, repeat the steps described above.

### Functionality check

When the vehicle is not moving, the electric parking brake might be applied automatically. This is done to check the system.

### Fault

Failure mode of electric parking brake is indicated by a control indicator  and by a vehicle message which is displayed in the Driver Information Centre.

Vehicle messages ⇨ 114.

Control indicator (P) flashes: electric parking brake is not fully applied or released. When continuously flashing, release electric parking brake and retry applying.

### Brake assist

If brake pedal is depressed quickly and forcefully, maximum brake force is automatically applied.

Operation of brake assist might become apparent by a pulse in the brake pedal and a greater resistance when depressing the brake pedal.

Maintain steady pressure on the brake pedal as long as full braking is required. Maximum brake force is automatically reduced when brake pedal is released.

### Hill start assist

The system helps prevent unintended movement when driving away on inclines.

When releasing the brake pedal after stopping on an incline, brakes remain on for further 2s. The brakes release automatically as soon as the vehicle begins to accelerate.

## Ride control systems

### Electronic Stability Control and Traction Control system

Electronic Stability Control (ESC) improves driving stability when necessary, regardless of the type of road surface or tyre grip.

As soon as the vehicle starts to swerve (understeer / oversteer), engine output is reduced and the wheels are braked individually.

ESC operates in combination with the Traction Control system (TC). It prevents the driven wheels from spinning.

The TC is a component of the ESC.

Traction Control improves driving stability when necessary, regardless of the type of road surface or tyre grip, by preventing the driven wheels from spinning.

As soon as the driven wheels starts to spin, engine output is reduced and the wheel spinning the most is braked

individually. This considerably improves the driving stability of the vehicle on slippery road surfaces.



ESC and TC are operational after each engine start as soon as the control indicator  extinguishes.

When ESC and TC operate,  flashes.

#### Warning

Do not let this special safety feature tempt you into taking risks when driving.

Adapt speed to the road conditions.

Control indicator  ⇨ 104.

### Deactivation



ESC and TC can be deactivated, everytime it is required: press .

The LED in the button  illuminates.

A status message appears in the Driver Information Centre when ESC and TC are deactivated.

ESC and TC are reactivated by pressing the  button again, by applying the brake or in the case that the vehicle is driven faster than 30 mph.

The LED in the button  extinguishes when ESC and TC are reactivated.

ESC and TC are also reactivated the next time the ignition is switched on.

## Fault

If there is a fault in the system, the control indicator  illuminates continuously and a message appears in the Driver Information Centre. The system is not operational.

Have the cause of the fault remedied by a workshop.

## Descent control system

The descent control system allows the vehicle to travel at a low speed without depressing the brake pedal. The vehicle will automatically decelerate to a low speed and remain at that speed when the system is activated. Some noise or vibration from the brake system may be apparent when the system is active.

### Caution

Use only when descending steep grades while driving off-road. Do not use when driving on normal

road surfaces. Unnecessary usage of the DCS function, such as while driving on normal roads, may damage the brake system and the ESC function.



## Activation

### Notice

If hill descent control is active, active emergency braking is automatically deactivated.

The systems is only available for slopes greater than 5%.





At speeds below approx. 30 mph, press . The system can also be activated when the vehicle is stationary with the engine running. The control indicator  in the instrument cluster is illuminated in green to show the system is activated.

When the vehicles starts its descent, the system controls the speed of the vehicle; accelerator and brake pedals can be released.



- If the gearbox is in first or second gear, the speed decreases and the control indicator in the instrument cluster flashes rapidly.
- If the gearbox is in neutral or the clutch pedal is released, the speed decreases and the control indicator in the instrument cluster flashes slowly.

If the system is operating, the brake lights automatically come on.

If the speed exceeds 18 mph, regulation is paused. The  indicator light in the instrument cluster changes to grey. However, the LED

of the  button is still illuminated. Regulation is automatically resumed if the speed falls below 18 mph, the slope is greater than 5% and the pedal release conditions are met.

### Deactivation

Press  again until the LED in the button extinguishes. The green control indicator  in the instrument cluster extinguishes, too.

Depressing the foot brake or accelerator will also cause the system to be deactivated.

If the speed exceeds 43 mph, the system is automatically deactivated. The LED in the button extinguishes.

### Fault

If the green control indicator  does not illuminate or flash after pressing the button, there is a fault in the system.

Seek the assistance of a workshop.

## Selective ride control

### Caution

The vehicle is designed to drive principally on-road, but it also enables driving off-road occasionally.

However, do not drive on terrain where the vehicle could be damaged due to obstacles, such as rocks among others and on terrain with steep inclines and poor grip.

Do not cross waters.

### Caution





When driving off-road, sudden motion and manoeuvres can cause a collision or losing control.

Selective ride control is designed to optimise traction in low-grip conditions (snow, mud and sand).

It adapts to the terrain by acting on the front wheels, in doing so this saves the weight normally associated with a more conventional four wheel drive system.



Selective ride control allows to choose between five driving modes:

- ESC off mode 
- standard mode 
- snow mode 
- mud mode 
- sand mode 

The several modes can be activated by turning the control.

A LED illuminates and a status message appears in the Driver Information Centre to confirm the chosen mode.

### ESC off mode

The ESC and Traction Control are deactivated in this mode.

An LED in the button  illuminates.

ESC and Traction Control are reactivated automatically from 30 mph or everytime the ignition is switched on.

### Standard mode

This mode is calibrated for a low level of wheel spin, based on the different types of grip generally encountered in normal day to day driving.

Everytime the ignition is switched off, the system is automatically reset to this mode.

### Snow mode

This mode adapts to the grip conditions encountered by each wheel when starting.

When advancing, the system optimises wheel spin to guarantee the best acceleration based on the available traction. Recommended in cases of deep snow and steep inclines.

This mode is active up to a speed of 30 mph.

### Mud mode

This mode allows considerable wheel spin at start-up for the wheel with the least grip, this removes mud and re-establishes traction.

Simultaneously, the wheel with the most grip is provided with the most torque possible.

This mode is active up to a speed of 50 mph.

### Sand mode

This mode allows a small amount of simultaneous wheel spin on the two drive wheels, enabling the vehicle to advance and reduce the risk of sinking.

This mode is active up to a speed of 75 mph.

## Caution

Do not use the other modes on sand as the vehicle may become stuck.



## Driver assistance systems

### ⚠ Warning

Driver assistance systems are developed to support the driver and not to replace the driver's attention.

The driver accepts full responsibility when driving the vehicle.

When using driver assistance systems, always take care regarding the current traffic situation.

## Cruise control

The cruise control can store and maintain speeds above 25 mph. Additionally at least the third gear must be engaged on manual transmission, on automatic transmission position **D** or the second or a higher gear in position **M** must be selected.

Deviations from the stored speeds may occur when driving uphill or downhill.

The system maintains the vehicle speed at the preset speed by the driver, without any action on the accelerator pedal.

The preset speed can be exceeded temporarily by pressing the accelerator pedal firmly.



The status and preset speed is displayed in the Driver Information Centre.

Do not use the cruise control if it is not advisable to maintain a constant speed.

Control indicator   107.

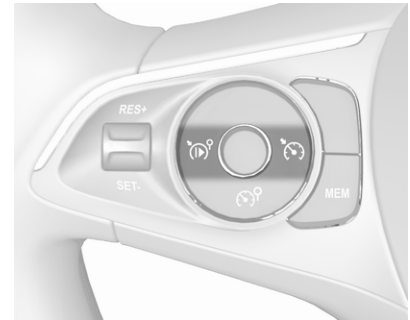
## Switching on the system



Press , symbol  and a message are displayed in the Driver Information Centre. The system is still not active.



## Activation of the functionality

### Setting speed by the driver

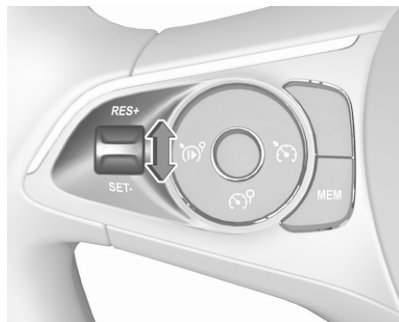

Accelerate to the desired speed and press thumb wheel once briefly to **RES/+** or **SET/-**. The current speed is stored and maintained. Accelerator pedal can be released.

The preset speed can then be changed by pressing thumb wheel to **RES/+** to increase or **SET/-** to decrease the speed. Short press changes speed in small steps, long press in large steps.

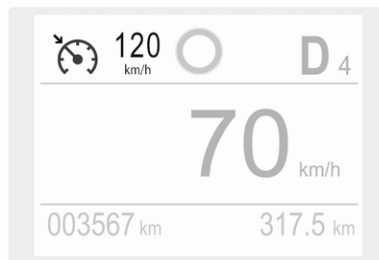

Speed value is indicated in the Driver Information Centre.

## Adopting speed by the speed limit recognition

The intelligent speed adaptation informs the driver when a speed limit is detected by the speed limit recognition. The detected speed limit can be used as new value for the cruise control.

Using a camera at the top of the windscreen, this system detects and reads speed limit and end of speed limit signs. The system also takes account of information on speed limits from the navigation map data.

The function can be deactivated or activated in the personalisation menu  $\rightarrow$  115.

If the cruise control is active, the recognised speed limit will be displayed in the Driver Information Centre and **MEM** illuminates.

The displayed information depends on the Driver Information Centre version.

In the Driver Information Centre, speed limit sign is shown in the display and **MEM** illuminates for a few seconds.

Press **MEM** on the steering wheel to request saving of the suggested speed.

Press **MEM** on the steering wheel once more to confirm and save the new speed setting.

This speed is the new value for the cruise control.

### Exceeding the set speed

Vehicle speed can be increased by depressing the accelerator pedal.

When the accelerator pedal is released, the previously stored speed is resumed.

### Deactivation of the functionality

Press , cruise control is in pause mode and a message is displayed. The vehicle is driven without cruise control.

Cruise control is deactivated, but not switched off. Last stored speed remains in memory for later speed resume.

Cruise control is deactivated automatically:

- The brake pedal is depressed.
- Vehicle speed is below 25 mph.
- The Traction Control system or Electronic Stability Control is operating.
- The selector lever is in **N** (automatic transmission) / the first or second gear (manual transmission).

### Resume stored speed

Press thumb wheel to **RES/+** at a speed above 25 mph. The stored speed will be obtained.

### Switching off the system

Press , the cruise control mode is deselected and the cruise control indication extinguishes in the Driver Information Centre.

Pressing  to activate the speed limiter deactivates cruise control.

Switching off the ignition cancels any programmed speed value.

### Fault

In the event of a cruise control fault, the speed is cleared resulting in flashing of the dashes.

The cruise control may not operate correctly if traffic signs do not comply with the Vienna Convention on Road Signs and Signals.

### Speed limiter

The speed limiter prevents the vehicle exceeding a preset maximum speed.

The maximum speed can be set at speeds above 18 mph.



The driver can accelerate the vehicle up to the preset speed. Deviations from the limited speed may occur when driving downhill.

The preset speed can be exceeded temporarily by pressing the accelerator pedal firmly.

The status and preset speed limit are displayed in the Driver Information Centre.

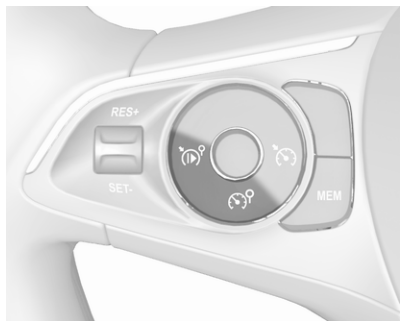
### Switching on the system



Press , symbol  and a message are displayed in the Driver Information Centre. The system is still not active.



### Activation of the functionality

#### Setting speed by the driver

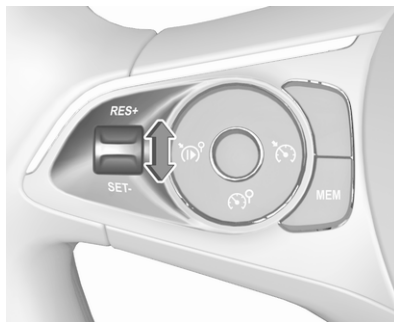

Press thumb wheel once briefly to **RES/+** or **SET/-**.

Following the preset speed can be set by pressing thumb wheel to **RES/+** to increase or **SET/-** to decrease the desired maximum speed. Short press changes preset speed in small steps, long press in large steps. Speed value is indicated in the Driver Information Centre.

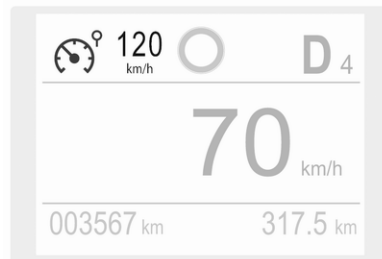

Press  to activate speed limiter.

#### Adopting speed by the traffic sign assistant

The intelligent speed adaptation informs the driver when a speed limit is detected by the traffic sign

assistant. The detected speed limit can be used as new value for the speed limiter.

Using a camera at the top of the windscreen, this system detects and reads speed limit and end of speed limit signs. The system also takes account of information on speed limits from the navigation map data.

The function can be activated or deactivated in the personalisation menu → 115.

If the speed limiter is active, the recognised speed limit will be displayed in the Driver Information Centre and **MEM** illuminates.

The displayed information depends on the Driver Information Centre version.

In the Driver Information Centre, speed limit sign is shown and **MEM** illuminates for a few seconds.

Press **MEM** on the steering wheel to request saving of the suggested speed.

Press **MEM** on the steering wheel once more to confirm and save the new speed setting.

This speed is the new value for the speed limiter.

### Exceeding the speed limit

In the event of an emergency, it is possible to exceed the speed limit by depressing the accelerator pedal firmly nearly to the final point.

Release the accelerator pedal and the speed limiter function is reactivated once a speed lower than the limit speed is obtained.

### Deactivation of the functionality

Press , speed limiter is in pause mode and a message is displayed. The vehicle is driven without speed limit.

Speed limiter is deactivated, but not switched off. Last stored speed remains in memory for later speed resume.

### Resume limit speed

Press , the stored speed limit will be obtained.

### Switching off the system

Press , the speed limiter mode is deselected and the speed limit indication extinguishes in the Driver Information Centre.

Pressing ) to activate cruise control deactivates speed limiter.

The preset speed remains in the memory when the ignition is switched off.

### Fault

In the event of a speed limiter fault, the speed is cleared resulting in flashing of the dashes.

The speed limiter may not operate correctly if traffic signs do not comply with the Vienna Convention on Road Signs and Signals.

### Adaptive cruise control

The adaptive cruise control is an enhancement to the conventional cruise control with the additional feature of maintaining a certain following distance to the vehicle ahead. It uses a camera at the top of

the windscreen and camera sensors to detect the vehicles ahead. If no vehicle is detected in the driving path, the adaptive cruise control will behave like a conventional cruise control.

The adaptive cruise control automatically decelerates the vehicle when approaching a slower moving vehicle. It then adjusts the vehicle speed to follow the vehicle ahead at the selected following distance. The vehicle speed increases or decreases to follow the vehicle ahead, but will not exceed the set speed. It may apply limited braking with activated brake lights.

If the vehicle ahead accelerates or changes lane, the adaptive cruise control progressively accelerates the vehicle to return to the stored set speed. If the driver operates the turn lights to overtake a slower vehicle, the adaptive cruise control allows the vehicle to temporarily approach the vehicle ahead to help passing it. However, the set speed will never be exceeded.

The adaptive cruise control can store set speeds for manual transmission. If the vehicle ahead is moving too slowly and the selected following distance cannot be maintained anymore, a warning chime is given and a message is displayed in the Driver Information Centre. The message prompts the driver to take back control of the vehicle. On vehicles with automatic transmission, the system can brake the vehicle until a full stop.



The adaptive cruise control can store set speeds over 19 mph for manual transmission. If the vehicle ahead is moving too slowly and the selected following distance cannot be maintained anymore, a warning chime is given and a message is displayed in the Driver Information Centre. The message prompts the driver to take back control of the vehicle. On vehicles with automatic transmission, the system can brake the vehicle until a full stop.

### **Warning**

The complete driver attention is always required while driving with adaptive cruise control. The driver stays fully in control of the vehicle because the brake pedal, the accelerator pedal and the button  have priority over any adaptive cruise control operation.

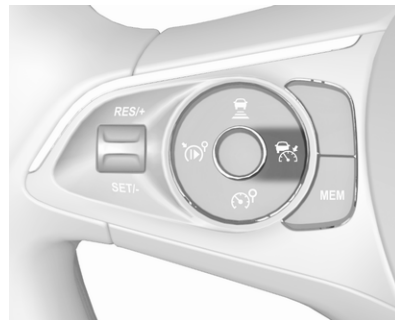
### **Switching on the system**



Press , the symbol  is indicated in the Driver Information Centre. The system is still not active.



### Activation of the functionality by setting the speed

The adaptive cruise control has to be switched on manually at a speed between **19 mph** and 112 mph.

For vehicles with automatic transmission, the automatic selector lever must be in position **D** or **M**.

Accelerate to the desired speed and move the thumb wheel to **SET/-**. The current speed is stored and maintained.

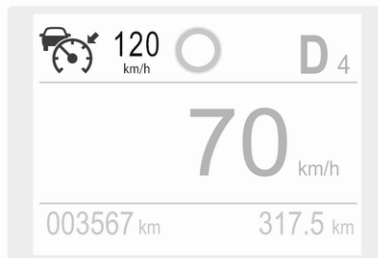

The speed value is indicated in the Driver Information Centre.

When the adaptive cruise control is operating, the stop-start system is automatically deactivated.

### Overriding set speed

It is always possible to drive faster than the selected set speed by depressing the accelerator pedal. When the accelerator pedal is released, the vehicle returns to the stored speed. If a slower moving vehicle is ahead, the following distance selected by the driver is restored.

If the set speed is exceeded, the indicated speed setting flashes in the Driver Information Centre and a warning message appears.

### **Warning**

Accelerating by the driver deactivates automatic braking by the system. This is indicated as a pop-up warning in the Driver Information Centre.

### Increasing speed

With the adaptive cruise control active, hold the thumb wheel moved to **RES/+** or briefly move to **RES/+** repeatedly: The speed increases continuously or in small increments.

### Reducing speed

With the adaptive cruise control active, hold the thumb wheel moved to **SET/-** or briefly move to **SET/-** repeatedly: The speed decreases continuously or in small increments.

## Resuming stored speed

Move the thumb wheel to **RES/+** at a speed above 19 mph. The adaptive cruise control is activated with the stored set speed.

## Taking over the speed limit from the traffic sign assistant

The intelligent speed adaptation informs the driver when a speed limit is detected by the traffic sign assistant. The detected speed limit can be taken over as new set speed for the adaptive cruise control.

With the camera at the top of the windscreen, this system detects and reads speed limit and end of speed limit signs. The system also takes account of information on speed limits from the navigation map data.

The function can be activated or deactivated in the personalisation menu ↗ 115.

If the adaptive cruise control is active, the recognised speed limit will be displayed in the Driver Information Centre and **MEM** illuminates.

In the Driver Information Centre, speed limit sign is shown in the display and **MEM** illuminates for a few seconds.

Press **MEM** on the steering wheel to request saving of the suggested speed.

Press **MEM** on the steering wheel once more to confirm and save the new speed setting.

This speed limit is now the new set speed of the adaptive cruise control.

## Adaptive cruise control on vehicles with automatic transmission

For vehicles with automatic transmission, adaptive cruise control allows to maintain the selected distance behind a stopping vehicle until a complete stop is reached.

If the system has stopped your vehicle behind another vehicle, then the set speed is replaced by a green control indicator (A). This symbol notifies, that the vehicle is hold automatically in stop position.

If the stopped vehicle ahead was stopped for a longer time and then begins to move forward, the green illuminated vehicle ahead control indicator (A) will flash and a warning chime will sound as a reminder to check traffic before resuming.

When the vehicle ahead drives away, press the accelerator pedal until 19 mph and then move the thumb wheel to **SET-** or **RES+** to resume adaptive cruise control. If the vehicle stays stopped for more than five minutes or if the driver's door is opened and the driver's seat belt is unfastened, then the electric parking brake is applied automatically to hold the vehicle. Control indicator (P) will illuminate. To release electric parking brake, press the accelerator pedal.

Electric parking brake ↗ 160.

### Warning

When the system is deactivated or cancelled, the vehicle will no longer be held at a stop and can



start moving. Be always prepared to manually apply the brake to hold the vehicle stationary.

Do not leave the vehicle while it is being held at a stop by adaptive cruise control. Always move selector lever to park position **P** and switch off the ignition before leaving the vehicle.

### Setting the following distance

When adaptive cruise control detects a slower moving vehicle in the driving path, it will adjust the vehicle speed to maintain the following distance selected by the driver.

The following distance can be set to close (1 bar), normal (2 bars) or far (3 bars).

If the engine is running and the adaptive cruise control is enabled (grey), you can modify the following distance setting:

Press **RES+**, the current setting is shown in the Driver Information Centre.



Press **RES+** again to change the following distance: The new setting is displayed in the Driver Information Centre.

The selected following distance is indicated by full bars in the adaptive cruise control page.

### **Warning**

The driver accepts full responsibility for the appropriate following distance based on traffic, weather and visibility conditions. Following distance must be adjusted or the system switched off when required by the prevailing conditions.

### Detecting the vehicle ahead

If the system detects a vehicle in the driving path, the adaptive cruise control symbol displayed in the Driver Information Centre changes:  is changed to .

### Deactivation of the functionality

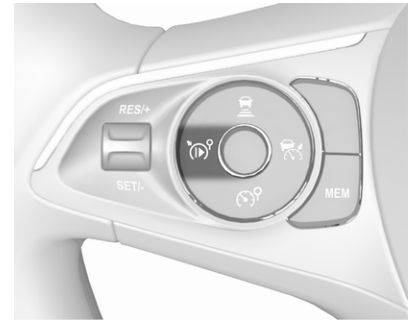

Press , the adaptive cruise control is in pause mode and a message is displayed. The vehicle is driven without adaptive cruise control.

The adaptive cruise control is deactivated, but not disabled. The last stored set speed remains in memory for later usage.

The adaptive cruise control is deactivated automatically when:

- The brake pedal is depressed.
- The vehicle accelerates above 112 mph or slows down below 19 mph.

- The electric parking brake is applied.
- The Traction Control system or Electronic Stability Control is deactivated or operating.
- The selector lever of automatic transmissions is neither in **D** nor in **M**.
- A fault is detected in the Electronic Stability Control.

### Switching off the system

Press , the adaptive cruise control mode is disabled and the adaptive cruise control indication extinguishes in the Driver Information Centre.

Pressing  to activate the speed limiter deactivates adaptive cruise control.

Switching off the ignition deletes the stored set speed.

### Driver's attention

- Use the adaptive cruise control carefully on bends or mountain roads, as it can lose the vehicle ahead and needs time to detect it again.

- Do not use the system on slippery roads as it can create rapid changes in tyre traction (wheel spinning), so that you could lose control of the vehicle.
- Do not use the system when the spare wheel is in use.

### System limits

#### Warning

The system's automatic brake force does not permit hard braking and the braking level may not be sufficient to avoid a collision.

- After a sudden lane change, the system needs a certain time to detect the next preceding vehicle. So if a new vehicle is detected, the system may accelerate instead of braking.
- The adaptive cruise control does ignore the oncoming traffic.
- The adaptive cruise control does not consider pedestrians and animals for braking and driving off.

- The adaptive cruise control considers stopped vehicles only at low speed.
- Do not use the adaptive cruise control when towing a trailer.
- Do not use the adaptive cruise control on roads with an incline of more than 10%.

### Bends

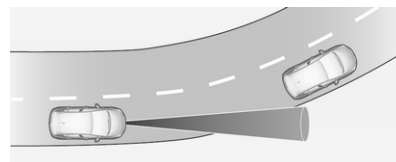

The adaptive cruise control calculates a predicted path based on the centrifugal force. This predicted path considers the current bend characteristic, but cannot consider a future bend change. The system may lose the current vehicle ahead or consider a vehicle which is not in the actual lane. This can happen when entering or exiting a bend or if the bend gets stronger or weaker. If it no

longer detects any vehicle ahead, then control indicator  will extinguish.

If the centrifugal force is too high in a bend, the system slows down the vehicle slightly. This braking level is not designed to avoid spinning-off the bend. The driver is responsible for reducing the selected speed before entering a bend and in general to adapt the speed to the road type and to existing speed limits.

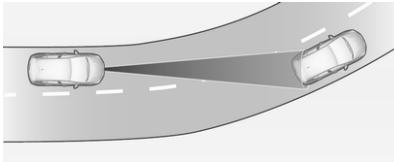

### Motorways

On motorways, adapt the set speed to the situation and the weather. Always consider that adaptive cruise control has a limited visibility range, a limited braking level and a certain reaction time to verify if a vehicle is on the driving path or not. Adaptive cruise control may not be able to brake the vehicle in time to avoid a

collision with a much slower vehicle or after a lane change. This is particularly true while driving fast or if the visibility is reduced due to weather conditions.

While entering or exiting a motorway, adaptive cruise control may lose the vehicle ahead and accelerate up to the set speed. For this reason, decrease the set speed before the exit or before the entry.

### Vehicle path changes

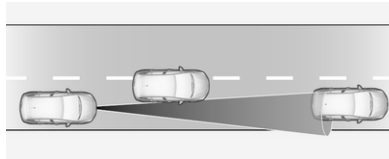

If another vehicle enters your driving path, adaptive cruise control will first consider the vehicle when it is completely in your path. Be ready to take action and depress the brake pedal, if you need to brake more quickly.

### Hill considerations



#### Warning

Do not use the adaptive cruise control on steep hill roads.

System performance on hills depends on vehicle speed, vehicle load, traffic conditions and the road incline. It may not detect a vehicle in your path while driving on hills. On steep hills, you may have to use the accelerator pedal to maintain your vehicle speed. When going downhill you may have to brake to maintain or reduce your speed.

Note that applying the brake deactivates the system.

## Fault

In the event of a fault with the adaptive cruise control, you are alerted by the illumination of a warning light and the display of a message in the instrument panel, accompanied by an audible signal.

The adaptive cruise control may not operate correctly if traffic signs do not comply with the Vienna Convention on Road Signs and Signals.

Have the system checked by a dealer or a qualified workshop.

As a safety measure, do not use the system if the brake lights are faulty.

## Forward collision alert

The forward collision alert may help to avoid or reduce the harm caused by front-end crashes.

The forward collision alert uses the front camera in the windscreen to detect a preceding vehicle directly ahead, in your path.

If a vehicle directly ahead is approached too quickly, a warning chime and alert in the Driver Information Centre is provided.

### Warning

Forward collision alert is just a warning system and does not apply the brakes. When approaching a vehicle ahead too rapidly, it may not provide you enough time to avoid a collision.

The driver accepts full responsibility for the appropriate following distance based on traffic, weather and visibility conditions.



The complete attention of the driver is always required while driving. The driver must always be ready to take action and apply the brakes.

## Activation

Forward collision alert detects vehicles and operates automatically at all speeds above 3 mph and 53 mph. The system detects stationary vehicles if the speed does not exceed 50 mph.

## Alerting the driver

The driver is warned by following alerts:

- Symbol  illuminates and a warning message is displayed in the Driver Information Centre when the distance to the vehicle ahead gets to small.
- Symbol  illuminates, a warning message is displayed in the Driver Information Centre and a warning chime sounds, when a collision is imminent and immediate driver's action is required.

### Warning

Forward collision alert is just a warning system and does not apply the brakes. When approaching a vehicle ahead too rapidly, it may not provide you enough time to avoid a collision.

The driver accepts full responsibility for the appropriate following distance based on traffic, weather and visibility conditions.

The complete attention of the driver is always required while driving. The driver must always be ready to take action and apply the brakes.

### Caution

The colour lighting of this control indicator does not correspond to local traffic laws on following distance. The driver bears full responsibility for maintaining safe following distance according to

applicable traffic rules, weather and road conditions etc. at all times.

### Selecting the alert sensitivity

The alert sensitivity has to be set to close, normal or distant in the vehicle personalisation menu ⇨ 115.

The chosen setting will remain until it is changed. The alert timing will vary based on vehicle speed. The faster the vehicle speed, the farther away the alert will occur. Consider traffic and weather conditions when selecting the alert timing.

### Deactivation

The system can only be deactivated by deactivating the active emergency braking in the vehicle personalisation ⇨ 115.

### System limitations

Forward collision alert is designed to warn on vehicles only, but may react also to other objects.

In the following cases, forward collision alert may not detect a vehicle ahead or sensor performance is limited:

- driving on winding or hilly roads
- driving during nighttime
- weather limits visibility, such as fog, rain, or snow
- the sensor in the windscreen is blocked by snow, ice, slush, mud, dirt etc.
- the windscreen is damaged or affected by foreign objects, e.g. stickers

### Active emergency braking

Active emergency braking can help to reduce the damage and injury from crashes with vehicles, pedestrians and obstacles directly ahead, when a collision can no longer be avoided either by manual braking or by steering. Before the active emergency braking applies, the driver is warned by the forward collision alert or the front pedestrian protection alert.

Forward collision alert ⇨ 178

Front pedestrian protection ⇨ 182

The feature uses various inputs (e.g. camera sensor, brake pressure, vehicle speed) to calculate the probability of a frontal collision.

### **⚠ Warning**

This system is not intended to replace the driver responsibility for driving the vehicle and looking ahead. Its function is limited to supplemental use only to reduce the vehicle speed before a collision.

The system may not react to animals. After a sudden lane change, the system needs a certain time to detect the next preceding vehicle.

The driver must always be ready to take action and apply the brakes and steer to avoid collisions.

### **Functionality**

Active emergency braking is equipped with a front camera and operates in forward gear in the range between walking speed and 53 mph. The system detects stationary vehicles only if the speed does not exceed 50 mph.

A precondition is that active emergency braking is not deactivated in the vehicle personalisation menu ⇨ 115.

If deactivated, (Ⓜ) illuminates in the instrument cluster and a warning message is displayed in the Driver Information Centre

If the system has been deactivated manually, it is reactivated automatically the next time the ignition is switched on.

The system includes:

- emergency automatic braking
- forward collision alert
- front pedestrian protection

### **Emergency automatic braking**

After activation of brake preparation system and just before the imminent collision, this function automatically applies limited braking to reduce the impact speed of the collision or prohibit a crash.

If active emergency braking is applied, (Ⓜ) flashes in the instrument cluster.

Depending on the situation, the vehicle may automatically brake moderately or hard.

Front automatic braking can only occur if a vehicle or a pedestrian ahead is detected.

Forward collision alert ⇨ 178

Front pedestrian protection ⇨ 182

Below a speed of 19 mph, emergency automatic braking may slow down the vehicle to a complete stop. If the speed exceeds 19 mph, emergency automatic braking reduces the speed. However, the driver must apply the brake.

Emergency automatic braking may slow the vehicle to a complete stop to try to avoid a potential crash.

- Automatic transmission: If the vehicle comes to a complete stop, automatic braking is maintained for up to two seconds. Keep the brake pedal depressed to prevent the vehicle from starting off again.
- Manual transmission: If the vehicle comes to a complete stop, the engine may stall.

Operation of the function may be felt by a slight vibration in the brake pedal.

### Warning

Emergency automatic braking is an emergency crash preparation feature and is not designed to avoid crashes. Do not rely on the system to brake the vehicle. Emergency automatic braking will not brake outside of its operating speed range and only responds to detected vehicles and pedestrians.

### System limitations

In some cases, the active emergency braking system may provide an automatic braking in situations that seem to be unnecessary, for instance in parking garages, due to traffic signs in a curve or due to vehicles in another lane. This is normal operation, the vehicle does not need service. Firmly apply the accelerator pedal to override the automatic braking if the situation and the surroundings permit.

In the following cases, active emergency braking performance is limited:

- driving on winding or hilly roads
- detecting all vehicles, especially vehicles with a trailer, tractors, muddy vehicles, etc.
- detecting a vehicle when weather limits visibility, such as in fog, rain, or snow
- driving during nighttime
- windscreen damaged or stickered

Complete attention is always required while driving, and you should be ready to take action and apply the brakes and / or steer the vehicle to avoid crashes.

We recommend to deactivate the system in the vehicle personalisation in the following cases:

- when towing a trailer or caravan
- when carrying long objects on roof bars or a roof rack
- when the vehicle is being towed with the engine running
- when a spare wheel is fitted that is smaller than the other wheels
- before using an automatic car wash with the engine running
- before placing the vehicle on a rolling road in a workshop
- if the windscreen has been damaged close to the camera
- if the front bumper has been damaged
- if the brake lights are not working

**Fault**

In case the system requires a service,  is illuminated in the instrument cluster, a message is displayed in the Driver Information Centre and an audible signal is given.

If the system does not work as it should do, vehicle messages are displayed in the Driver Information Centre.

Vehicle messages ⇨ 114.

**Front pedestrian protection**

Front pedestrian protection may help to avoid or reduce the harm caused by front-end crashes with pedestrians when driving forward.

The system uses the front camera in the windscreen to detect a pedestrian directly ahead in your path.

Front pedestrian protection can detect and alert to pedestrians in a forward gear at speeds between 3 mph and 37 mph.

During nighttime driving, system performance is limited.

** Danger**

Front pedestrian braking does not provide an alert or automatically brake the vehicle, unless it detects a pedestrian.

The system may not detect pedestrians, including children, when the pedestrian is not directly ahead, not fully visible, not standing upright, or when part of a group.

Front pedestrian protection includes:

- detecting front pedestrian ahead
- front pedestrian alert

Front pedestrian protection is activated together with forward collision alert.

Forward collision alert ⇨ 178.

**Detecting front pedestrian ahead**

A pedestrian ahead up to a distance of approx. 40 m is indicated by a symbol in the instrument cluster.

**Front pedestrian alert**

When approaching a detected pedestrian too quickly, a warning message is displayed in the Driver Information Centre. A warning chime is provided.

Cruise control or Adaptive cruise control may be disengaged when the front pedestrian alert occurs.

**System limitations**

In the following cases, front pedestrian protection may not detect a pedestrian ahead or sensor performance is limited:

- vehicle speed is out of range from 3 mph to 37 mph in forward gear
- the distance to a pedestrian ahead is more than 40 m
- driving on winding or hilly roads
- driving during nighttime
- weather limits visibility, such as fog, rain, or snow



- the sensor in the windscreen is blocked by snow, ice, slush, mud, dirt etc.
- the windscreen is damaged or affected by foreign objects, e.g. stickers

## Parking assist

### General information

When attaching a trailer or bicycle carrier to the trailer hitch, the parking assist is deactivated.

#### Warning

The driver bears full responsibility for the parking manoeuvre.

Always check the surrounding area when driving backwards or forwards while using parking assist system.

### Rear parking assist

The system warns the driver with acoustic signals against potentially hazardous obstacles behind the vehicle in a distance range up to 50 cm while reverse gear is engaged.

The system operates with ultrasonic parking sensors in the rear bumper.

#### Activation

Rear parking assist is activated when reverse gear is engaged and ignition is switched on. This is confirmed by an acoustic chime.





Graphic Info Display: The system is ready to operate when the LED in the parking assist button  is not illuminated.

Colour Info Display: Activate the parking assist in the vehicle personalisation  115.

#### Indication

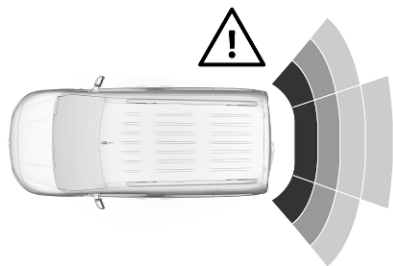
Depending on which side of the vehicle is closer to an obstacle, you will hear acoustic warning signals in the vehicle on the respective side. The interval between the sounds becomes shorter as the vehicle gets closer to that obstacle. When the distance is less than approx. 30 cm, the sound is continuous.



Additionally, the distance to rear obstacles is displayed by changing distance lines in the Info Display ↗ 110. When the obstacle is very close,  for danger is displayed.

### Deactivation

The system is switched off when reverse gear is disengaged. Press  to deactivate the system manually. The LED in the button illuminates when the system is deactivated. If the system has been deactivated manually, it is not reactivated automatically the next time the ignition is switched on.

**Graphic Info Display:** The system is switched off when the LED in the parking assist button  is illuminated.

**Colour Info Display:** Deactivate the parking assist in the vehicle personalisation ↗ 115. The state of the system

### Front-rear parking assist

The front-rear parking assist measures the distance between the vehicle and obstacles in front and behind the vehicle. It informs and warns the driver by giving acoustic signals and display indication.

It uses two different acoustic warning signals for the front and rear monitoring areas, each with a different tone frequency.

The system operates with ultrasonic parking sensors in the rear and front bumper.

### Activation

In addition to the rear parking assist, the front parking assist is triggered when an obstacle is detected in front and the speed of the vehicle is below 6 mph.

**Graphic Info Display:** The system is ready to operate when the LED in the parking assist button  is not illuminated.

**Colour Info Display:** Activate the parking assist in the vehicle personalisation ↗ 115.

### Indication

Depending on which side of the vehicle is closer to an obstacle, you will hear acoustic warning signals in the vehicle on the respective side. The interval between the sounds becomes shorter as the vehicle gets closer to that obstacle. When the distance is less than approx. 30 cm, the sound is continuous.

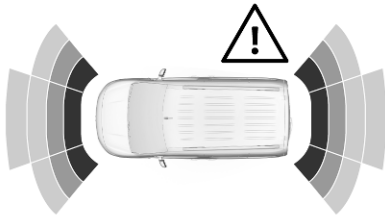

Additionally, the distance to rear and front obstacles is displayed by changing distance lines in the Info Display ↗ 110.

If the vehicle stops for more than three seconds in a forward gear, if automatic transmission is in **P** or if no further obstacles are detected, no acoustic warning signals are given.

### Deactivation

The system is deactivated automatically when vehicle speed exceeds 6 mph, by applying the electric parking brake or by pressing the parking assist button .

**Graphic Info Display:** The system is switched off when the LED in the parking assist button  is illuminated.

**Colour Info Display:** Deactivate the parking assist in the vehicle personalisation ↗ 115.

### Front-rear-lateral parking assist

The front-rear-lateral parking assist measures the distance between the vehicle and obstacles in front, behind and at the sides of the vehicle. It informs and warns the driver by giving acoustic signals and display indication.

The system operates with ultrasonic parking sensors in the rear and front bumper and on the flanks of the vehicle.

### Activation

In addition to the rear parking assist and the front-rear assist, the front-rear-lateral parking assist is triggered when the system detects fixed obstacles located to one or both sides of the vehicle.

**Graphic Info Display:** The system is ready to operate when the LED in the parking assist button  is not illuminated.

**Colour Info Display:** Activate the parking assist in the vehicle personalisation ↗ 115.

### Indication

Depending on which side of the vehicle is closer to an obstacle, you will hear acoustic warning signals in the vehicle on the respective side.

The interval between the sounds becomes shorter as the vehicle gets closer to that obstacle. When the distance is less than approx. 30 cm, the sound is continuous.

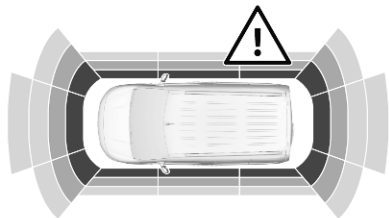

Additionally, the distance to rear, front and lateral obstacles is displayed by changing distance lines in the Colour Info Display ↷ 110.

### Deactivation

The system is deactivated automatically when vehicle speed exceeds 6 mph, by applying the electric parking brake or by pressing the parking assist button .

Graphic Info Display: The system is switched off when the LED in the parking assist button  is illuminated.

Colour Info Display: Deactivate the parking assist in the vehicle personalisation ↷ 115.

### System limitations

In the event of a fault or if the system does not work temporarily, e.g. because of high external noise level or other interference factors,  illuminates in the instrument cluster. A message is displayed in the Driver Information Centre.

### Warning

Under certain circumstances, various reflective surfaces on objects or clothing as well as external noise sources may cause the system to fail to detect obstacles.

Special attention must be paid to low obstacles which can damage the lower part of the bumper.

### Caution

Performance of the system can be reduced when sensors are covered, e.g. by ice or snow.

Performance of the parking assist system can be reduced due to heavy loading.

Special conditions apply if there are taller vehicles in the vicinity (e.g. off-road vehicles, mini vans, vans). Object identification and correct distance indication in the upper part of these vehicles cannot be guaranteed.

Objects with a very small reflection cross-section, e.g. objects of narrow size or soft materials, may not be detected by the system.

Parking assist systems do not detect objects outside the detection range.

## Advanced parking assist

### ⚠ Warning

The driver bears full responsibility for accepting the parking slot suggested by the system and the parking manoeuvre.

Always check the surrounding area in all directions when using the advanced parking assist.

The advanced parking assist measures a suitable parking slot while passing, calculates the trajectory and automatically steers the vehicle while parking.

Advanced parking assist provides assistance for the following manoeuvres:

- entry into a parallel parking slot
- entry into a perpendicular parking slot
- exit from a parallel parking slot

The driver must control acceleration, braking and gear shifting, while steering is done automatically. The driver can take control at any time by gripping the steering wheel.

It may be necessary to move forwards and backwards more than once.

Instructions are given in the Info Display ⇨ 110.

Advanced parking assist can only be activated when driving forwards.

### Entry into a parallel parking slot

#### Activation

Slow down the vehicle speed below 19 mph.

Colour Info Display: to search for a parking slot, activate the system by pressing . Select **Driving functions** on the Info Display and then **Park Assist**. Select **Enter parallel parking space**.

Select parking side by switching on the turn light on the respective side.

The allowed parallel distance between the vehicle and a row of parked cars is between 0.5 m and 1.5 m.

For entering into a parallel parking slot, the minimum length of the slot must be equal to the length of your vehicle plus 0.6 m. The system will not identify slots that are clearly smaller or larger than the vehicle.

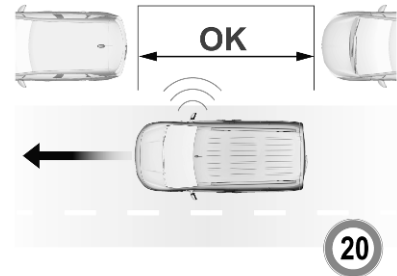

When a free slot is detected, a visual feedback on the Info Display and a first acoustic signal is given. Drive slowly forwards. When the second acoustic signal is given, stop the vehicle, select reverse gear, release the steering wheel and start moving slowly. A visual feedback is given on the Info Display.

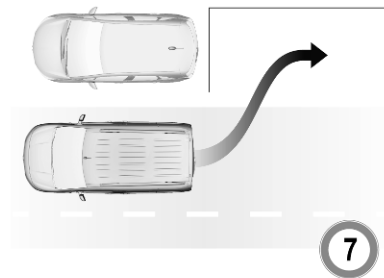

Move forwards and backwards while observing the warnings of the Parking assist until the end of manoeuvre is indicated.

### Entry into a perpendicular parking slot

#### Activation

Colour Info Display: when searching for a parking slot, activate the system by pressing . Select Driving functions on the Info Display and then **Park Assist**. Select **Enter bay parking space**.

Slow down the vehicle speed below 19 mph.

Select parking side by switching on the turn light on the respective side.

The allowed parallel distance between the vehicle and a row of parked cars is between 0.5 m and 1.5 m.

For entering into a perpendicular parking slot, the minimum width of the slot must be equal to the width of your vehicle plus 0.7 m. When several successive slots are found, the vehicle will be directed towards the last one.



When a free slot is detected, a visual feedback on the Info Display and an acoustic signal is given. Stop the

vehicle, select reverse gear, release the steering wheel and start moving without exceeding 4 mph.

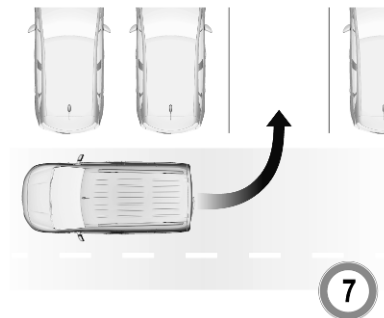

Move forwards and backwards as instructed by observing the warnings of the parking assist and paying attention to the acoustic signals until the end of manoeuvre is indicated. When finished, extinguishes in the instrument cluster.

During the parking manoeuvre, the system is automatically deactivated once the rear of the vehicle is within 50 cm of an obstacle.

## Exiting a parallel parking slot

### Activation

Colour Info Display: when exiting a parallel parking slot, activate the system by pressing . Select **Driving functions** on the Info Display and then **Park Assist**. Select **Exit parallel parking space**.

Select exit side by switching on the respective turn light.

Engage reverse or forward gear, release the steering wheel and start moving without exceeding 3 mph.

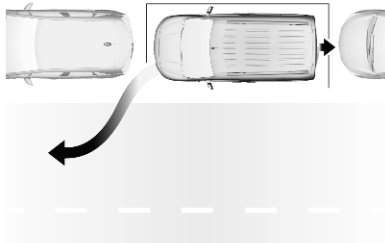

Move forwards and backwards while observing the warnings of the Parking assist until the end of manoeuvre is indicated. The manoeuvre is complete when the vehicle's front wheels are out of the parking slot.

After deactivation check control over the vehicle.

### Display indication

The instructions on the display show:

- general hints and warning messages
- the demand to stop the vehicle, when a parking slot is detected
- the direction of driving during the parking manoeuvre
- the demand to shift into reverse or first gear
- the demand to stop or to drive slowly
- the successful completion of the parking manoeuvre indicated by a pop-up symbol and a chime
- the cancelling of a parking manoeuvre

### Deactivation

The current park assist manoeuvre is cancelled via the button to return to the previous screen in the Info Display. To deactivate the system completely, press  in the centre console.

The system is deactivated automatically:

- if the ignition is switched off
- if stalling the engine
- if no manoeuvre is started within 5 minutes of selection of the type of manoeuvre
- after a prolonged stop of the vehicle during a manoeuvre
- if the Electronic Stability Control is triggered
- if the speed of the vehicle exceeds the stated limit
- when the driver interrupts movement of the steering wheel
- after seven manoeuvres for entering a perpendicular parking slot (a manoeuvre consists of one rear move or one forward move)

- after ten manoeuvres for entering or exiting a parallel parking slot
- on opening a door or the load compartment
- if one of the front wheels encounters an obstacle
- parking manoeuvre successfully ended

Deactivation by the driver or by the system during manoeuvring will be indicated on the display. Additionally, an acoustic signal sounds.

The system is switched off automatically when towing an electrically connected trailer, bicycle carrier, etc.

Contact your dealer to switch off the system for a prolonged period.

### Fault

In the event of a fault, a message is displayed in the Colour Info Display, accompanied by an acoustic signal.

In the event of a fault in the power steering,  illuminates and a message is displayed in the Driver Information Centre.

### Warning

Under certain circumstances, various reflective surfaces on objects or clothing as well as external noise sources may cause the system to fail to detect obstacles.

Special attention must be paid to low obstacles which can damage the lower part of the bumper.

### Caution

Performance of the system can be reduced when sensors are covered, e.g. by ice or snow.

Performance of the parking assist system can be reduced due to heavy loading.

Special conditions apply if there are taller vehicles in the vicinity (e.g. off-road vehicles, mini vans, vans). Object identification and correct distance indication in the upper part of these vehicles cannot be guaranteed.

Objects with a very small reflection cross-section, e.g. objects of narrow size or soft materials, may not be detected by the system.

Parking assist systems do not detect objects outside the detection range.

### Notice

It is possible that the sensor detects a non-existing object caused by echo disturbance from external acoustic noise or mechanical misalignments (sporadic false warnings may occur).

Make sure that the front number plate is properly mounted (not bent and no gaps to the bumper on the left or right side) and the sensors are firmly in place.

Advanced parking assist system may not respond to changes in the available parking space after initiating a parking manoeuvre. The system may recognize an entry, a gateway, a courtyard or even a crossing as a parking slot. After selecting reverse gear the system



will start a parking manoeuvre. Take care regarding the availability of the suggested parking slot.

Surface irregularities, e.g. on construction zones, are not detected by the system. The driver accepts responsibility.

## Side blind spot alert

The side blind spot alert system detects and reports objects on either side of the vehicle, within a specified blind spot zone. The system displays a visual alert in each exterior mirror, when detecting objects that may not be visible in the interior and exterior mirrors.

Side blind spot alert uses some of the advanced parking assist sensors which are located in the front and rear bumper on both sides of the vehicle.

### Warning

Side blind spot alert does not replace driver vision.

The system does not detect:

- vehicles outside the side blind zones which may be rapidly approaching
- pedestrians, cyclists or animals

Before changing a lane, always check all mirrors, look over the shoulder and use the turn signal.

## Activation

Colour Info Display: press . Select **Driving functions** on the Info Display and then **Blind spot sensors**. Activate the function.

<sup>A18</sup> illuminates continuously green in the instrument cluster to confirm the function.

## Functionality

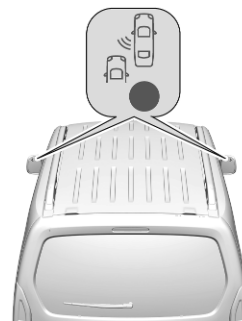

When the system detects a vehicle in the side blind zone while driving forwards, an LED will illuminate in the relevant exterior mirror.

The LED comes on immediately when being passed.

The LED comes on after a delay when passing another vehicle slowly.

### Operation conditions



The following conditions must be fulfilled for proper operation:

- all vehicles are moving in the same direction and in adjacent lanes
- the speed of your vehicle is between 7 and 87 mph
- passing a vehicle with a speed difference of less than 6 mph
- another vehicle is passing with a speed difference of less than 15 mph
- the traffic flow is normal
- driving on a straight or slightly curved road
- the vehicle is not pulling a trailer
- the sensors are not covered by mud, ice or snow
- the warning zones in the door mirrors or the detection zones on front and rear bumper are not covered with adhesive labels or other objects

No alert will be given in the following situations:

- in the presence of non-moving objects, e.g. parked vehicles, barriers, street lamps, road signs
- in very dense traffic, when moving vehicles might be confused with a stationary object
- with vehicles moving in the opposite direction
- driving on a winding road or a sharp corner
- when passing or being passed by a very long vehicle, e.g. lorry, coach, which is at the same time detected at the rear in the blind spot angle and present in the driver's forward field of vision
- when passing too quickly

### Deactivation



The system is deactivated in the vehicle personalisation  115.  extinguishes in the instrument cluster. Additionally, an acoustic signal sounds.

The state of the system is stored when switching off the ignition.

The system is automatically deactivated when towing an electrically connected trailer.

Due to adverse weather conditions such as heavy rain, false detections may occur.

### Fault

In the event of a fault,  flashes for a few moments in the instrument panel, accompanied by  and a display message. Have the cause of the fault remedied by a workshop.

### Passenger side camera

The passenger side camera monitors the side of the vehicle.



The camera is mounted at the bottom of the exterior mirror on the passenger side.

The passenger side view is displayed in the rear view display ↻ 113.

The area displayed by the camera is limited. The distance of the image that appears on the display differs from the actual distance.

### Switching on

The camera is switched on when the vehicle is running in forward gear and the passenger side view is selected from the rear view display.

### Guidelines

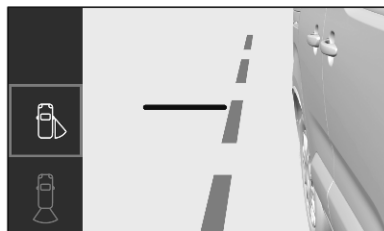

The line represents a distance of about 4 m beyond the edge of vehicle's rear bumper.

### Switching off

The camera is deactivated when another view type is selected.

### Panoramic view system

This system allows views of the vehicle's surroundings to be displayed as a nearly 180° picture in the Info display, like a bird's eye view.

The system uses:

- rear camera, installed in the tailgate
- ultrasonic parking sensors in the rear bumper

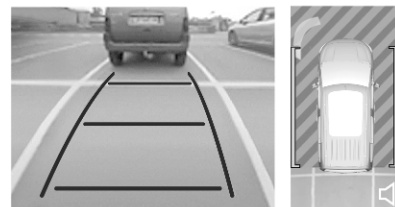

The screen in the Info display is divided into two parts. On the right there is a view from above the vehicle, and on the left there is the view from the rear displayed. The parking sensors complete the information on the view from above the vehicle.

Change the volume of the acoustic signals by pressing ◀ in the right lower zone of the display.

## Activation

Panoramic view system is activated by:

- engaging reverse gear
- driving up to 6 mph

## Functionality

Different views can be selected in the left part of the display. Change the type of view at any time during a manoeuvre by pressing the touch field in the left lower zone of the display:

- **Standard view**
- **AUTO Mode**
- **Zoom view**
- **180° view**

The display is immediately updated with the type of view selected.

**AUTO Mode** is activated by default. In this mode, the system selects the best view, standard or zoom, to display according to the information from the parking sensors.

The state of the system is not kept in memory when the ignition is switched off.

### Rear view / Standard view



The area behind the vehicle is displayed in the screen. The vertical lines represent the width of the vehicle with mirrors unfolded. The direction of the lines changes with the position of the steering wheel.

The first horizontal line represents a distance of about 30 cm beyond the edge of vehicle's rear bumper. The upper horizontal lines represent

distances of about 1 and 2 m beyond the edge of your vehicle's rear bumper.

This view is available in **AUTO Mode** or in the view selection menu.

### Rear zoom view / Zoom view



The camera records the vehicle's surroundings during the manoeuvre in order to reconstruct a view from above the rear of the vehicle in its near surroundings, allowing the vehicle to be manoeuvred around obstacles nearby. This view is available with **AUTO Mode** or in the view selection menu.

## Rear side view / 180° view

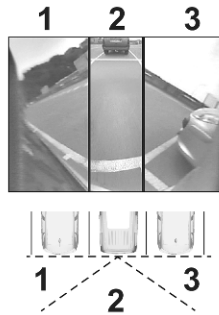

The 180° view facilitates reversing out of a parking bay, making it possible to see the approach of vehicles, pedestrians and cyclists. This view is not recommended for carrying out a complete manoeuvre. It is made up of three areas: left 1, centre 2 and right 3. This view is available from the view selection menu only.

## Deactivation

Panoramic view system is deactivated when:

- driving faster than 6 mph
- seven seconds after disengaging reverse gear
- by pressing the icon ← in the left upper corner of the touch screen and then ✕
- opening the tailgate
- attaching a trailer or a bike carrier

## General information

### ⚠ Warning

The panoramic view system does not replace driver vision. It will not display children, pedestrians, cyclists, crossing traffic, animals, or any other objects outside of the camera view area, e. g. below the bumper, or underneath the vehicle.

Do not drive or park the vehicle using only the panoramic view system.

Always check the surrounding of the vehicle before driving.

Displayed images may be further or closer than they appear. The area displayed is limited and objects that are close to either edge of the bumper or under the bumper are not displayed on the screen.

## System limitations

### Caution

For optimal operation of the system, it is important to keep the lense of the camera in the tailgate between the number plate lights always clean. Rinse the lense with water and wipe with a soft cloth.

Do not clean the lense with a steam-jet or high-pressure jet cleaner.

The panoramic view system may not operate properly when:

- The surrounding is dark.
- The sun or the beam of headlights is shining directly into the camera lenses.
- During nighttime driving.
- Weather limits visibility, such as fog, rain, or snow.
- The camera lenses are blocked by snow, ice, slush, mud, dirt.
- The vehicle is towing a trailer.
- The vehicle had an accident.
- There are extreme temperature changes.

## Rear view camera

Depending on version, camera is mounted above the license plate in the tailgate / left rear door or at the top of the left rear door.

### ⚠ Warning

The rear view camera does not replace driver vision. Note that objects that are outside the camera's field of view and the parking assist sensors, e.g. below the bumper or underneath the vehicle, are not displayed.

Do not reverse or park the vehicle using only the rear view camera.

Always check the surrounding of the vehicle before driving.

### Camera above the license plate on the tailgate / left rear door

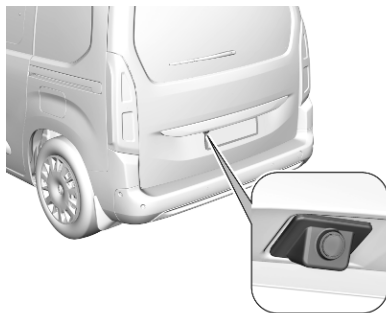

The view of the camera is displayed in the Info Display ↻ 110.

The area displayed by the camera is limited. The distance of the image that appears on the display differs from the actual distance.

### Switching on

Rear view camera is automatically activated when reverse gear is engaged.

### Guidelines

Dynamic guidelines are horizontal lines at one metre intervals projected onto the picture to define the distance to displayed objects.

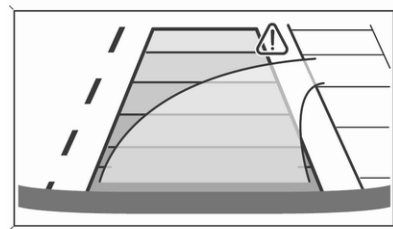

Trajectory lane of the vehicle is shown in accordance with the steering angle.

### Switching off

The camera is switched off when a forward gear is engaged.

### Camera at top of the left rear door



The view of the camera is displayed in the rear view display  113.

### Switching on

The rear view camera is automatically switched on.

The standard rear view is activated when a forward gear is engaged.

The close rear view is activated when selected via  in the rear view display or when the reverse gear is engaged.

When operating with a trailer, the close rear view is no longer operable.

### Guidelines

#### Standard rear view

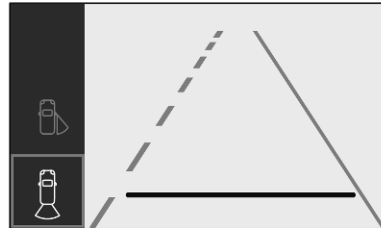

The horizontal line represents a distance of about 4 m beyond the edge of vehicle's rear bumper.

### Close rear view

The lower horizontal line represents a distance of about 30 cm beyond the edge of vehicle's rear bumper. The upper horizontal lines represent a distance of about 1 m and 2 m.

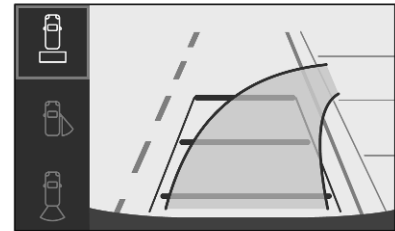

Trajectory lane of the vehicle is shown in accordance with the steering angle.

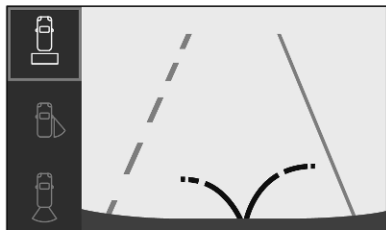

Additionally the opening radius of the rear doors are shown in the rear view display.

### Switching off

The rear view camera is switched off when the rear view display is switched off.

### System limitations

The rear view camera may not operate properly when:

- the surrounding is dark
- the beam of headlights is shining directly into the camera lenses

- weather limits visibility, such as fog, rain, or snow
- the camera lenses are blocked by snow, ice, slush, mud, dirt. Clean the lense, rinse with water, and wipe with a soft cloth
- the tailgate will be opened
- the vehicle is towing an electrically connected trailer, bicycle carrier, etc.
- the vehicle had a rear end accident
- there are extreme temperature changes

### Lane keep assist

Lane keep assist helps to avoid crashes due to unintentional lane departures. A front camera located at the top of the windscreen observes the lane markings between which the vehicle is driving. If the vehicle approaches a lane marking, the steering wheel is gently turned to position the vehicle back into the lane. The driver will then notice a turning movement of the steering wheel. Turn steering wheel in same direction, if

system steers not sufficient. Turn steering wheel gently into opposite direction, if lane change is intended. When the system steers to correct the trajectory of the vehicle,  flashes yellow in the instrument cluster.

A warning message in the Driver Information Centre accompanied by a warning chime alerts the driver when immediate driver's action is required.

Unintended lane departure is not assumed by the system when the turn lights are operated and during 20 s after turn lights have been switched off.

### Notice

The system may be switched off if it detects lanes which are too narrow, too wide or too curved.

Following preconditions have to be fulfilled:



- vehicle speed must be between 40 mph and 112 mph
- the driver must hold the steering wheel with both hands



- the change of trajectory is not accompanied by operation of the turn signals
- the Electronic Stability Control is activated and not in operation
- the vehicle is not connected to a trailer or an electric bicycle carrier
- normal driving behaviour (system detects dynamic driving style, i.e. pressure on the brake or accelerator pedal)
- roads with poor lane markings
- no spare wheel is used
- the driver needs to be active during the correction
- the vehicle is not driven in a tight corner

### Activation



If the system is activated, the LED in the button  is not illuminated. To activate the system when the system is deactivated, press .

The system is operational at vehicle speeds between 40 mph and 112 mph and if lane markings are detectable. The driver must hold the steering wheel with both hands. The Electronic Stability Control system must be activated.

The control indicator  flashes yellow during trajectory correction.

If the driver wishes to maintain the trajectory of the vehicle, he can prevent the correction by keeping a firm grip on the steering wheel, e.g. during an avoiding manoeuvre. The correction is interrupted if the turn lights are operated.

There is no correction triggered when the turn lights are operated and during a few seconds after turn lights have been switched off.

If the system detects that the driver is not holding the steering wheel firmly enough during an automatic correction of trajectory, it interrupts the correction. A warning message in the Driver Information Centre accompanied by a warning chime alerts the driver when immediate driver's action is required.

If the side blind spot alert is activated and the driver is about to change the lane, the system corrects the trajectory of the vehicle despite the activation of the turn lights if another vehicle is detected in the side blind spot zone.

## Deactivation

To deactivate the system, press and hold . Deactivation of the system is confirmed by the illuminated LED in the button. In the Driver Information Centre solid grey lines are displayed.

## Recommended deactivation



It is recommended to deactivate the system in the following situations:

- Road surface in poor condition
- Unfavourable climatic conditions
- Slippery surfaces, e.g., ice

The system is not designed for driving in the following situations:

- Driving on a speed circuit
- Driving with a trailer
- Driving on a rolling stand
- Driving on unstable surfaces

## Fault

In the event of a fault,  and  appear in the instrument panel, accompanied by a display message and a warning chime. Contact a dealer or a qualified workshop to have the system checked.

## System limitations

The system performance may be affected by:

- windscreen not clean or affected by foreign objects, e.g. stickers
- close vehicles ahead
- banked roads
- narrow, winding or hilly roads
- road edges
- sudden lighting changes
- adverse environmental conditions, e.g. heavy rain or snow
- vehicle modifications, e.g. tyres

Switch off the system if the system is disturbed by tar marks, shadows, road cracks, temporary or construction lane markings, or other road imperfections.

### Warning

Always keep your attention on the road and maintain proper vehicle position within the lane, otherwise vehicle damage, injury or death could occur.

Lane keep assist does not continuously steer the vehicle.

The system may not keep the vehicle in the lane or give an alert, even if a lane marking is detected.

The steering of the lane keep assist may not be sufficient to avoid a lane departure.

The system may not detect hands-off driving due to external influences like road condition and surface and weather. The driver has full responsibility to control the

vehicle and is always required to keep the hands on the steering wheel while driving.

Using the system while towing a trailer or on slippery roads could cause loss of control of the vehicle and a crash. Switch the system off.

## Driver alert

The driver alert system monitors the driving time and the vigilance of the driver. Monitoring the vigilance of the driver is based on the trajectory variations of the vehicle compared to the lane markings.

### Warning

The system cannot replace the need for vigilance on the part of the driver. Taking a break is recommended as soon as feeling tired or at least every two hours. Do not take the steering wheel when feeling tired.

## Activation or Deactivation

The system can be activated or deactivated in the vehicle personalisation  115.

The state of the system stays in memory when the ignition is switched off.

## Driving time alert

The driver gets notified by a pop-up reminder symbol  in the Driver Information Centre simultaneously with an acoustic alert if the driver has not taken a break after 2 hours of driving at a speed above 40 mph. The alert is repeated hourly until the vehicle is stopped, no matter how vehicle speed evolves.

The counting of driving time alert is reset if one of the following conditions is met:

- The vehicle has been stationary for more than 15 minutes with the engine running.
- The ignition has been switched off for a few minutes.
- The driver's seat belt has been unfastened and the driver's door is open.

### Notice

If the vehicle speed drops below 40 mph, the system is paused. The driving time is counted again once the speed is above 40 mph.

## Driver drowsiness detection

The system monitors the driver's level of vigilance. A camera at the top of the windshield detects variations in trajectory compared to the lane markings. This system is particularly suited to fast roads (speed higher than 40 mph).

If the trajectory of the vehicle suggests a certain level of drowsiness or inattention by the

driver, the system triggers the first level of alert. The driver is notified by a message and an audible signal is given.

After three first level alerts, the system triggers a new alert with a message, accompanied by a more pronounced audible signal.

In certain driving conditions (poor road surface or strong winds), the system may give alerts independent of the driver's level of vigilance.

The driver drowsiness detection is reinitialised when the ignition has been switched off for a few minutes or the speed remains below 40 mph for a few minutes.

### System limitations

In the following situations, the system may not operate properly or even not operate at all:

- poor visibility caused by inadequate lighting of the roadway, falling snow, heavy rain, dense fog etc.

- dazzle caused by headlights of oncoming vehicles, low sun, reflections on damp roads, leaving a tunnel, alternating shade and light etc.
- windscreen area in front of the camera covered by dirt, snow, stickers etc.
- no lane markings detected or multiple lane markings due to roadworks
- close vehicles ahead
- winding roads or narrow roads

## Fuel

### Fuel for petrol engines

The petrol engines are compatible with bio-fuels that conform to current and future European standards and can be obtained from filling stations:

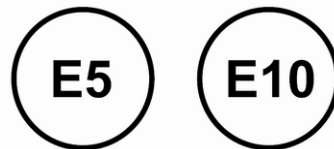

Petrol that meets the EN228 standard, mixed with a biofuel meeting the EN15376 standard.

Use fuel with the recommended octane rating. A lower octane rating can reduce engine power and torque and slightly increases fuel consumption.

**Caution**

Do not use fuel or fuel additives that contain metallic compounds such as manganese-based additives. This may cause engine damage.

**Caution**

Use of fuel with a lower octane rating than the lowest possible rating could lead to uncontrolled combustion and engine damage.

The engine specific requirements regarding octane rating are given in the engine data overview ↗ 260. A country-specific label at the fuel filler flap can supersede the requirement. In certain countries, the use of a particular fuel, e.g. a specific octane rating, may be required to ensure proper engine operation.

**Fuel for diesel engines**

The diesel engines are compatible with bio-fuels that conform to current and future European standards and can be obtained from filling stations:

A square label with a black border containing the text "B7" in bold black font.

Diesel fuel that meets standard EN590 mixed with a biofuel that meets standard EN14214 (possibly containing up to 7 % Fatty Acid Methyl Ester)

A square label with a black border containing the text "B10" in bold black font.

Diesel fuel that meets standard EN16734 mixed with a biofuel that meets standard EN14214 (possibly containing up to 10% Fatty Acid Methyl Ester)

A square label with a black border containing the text "XTL" in bold black font.

Paraffinic diesel fuel that meets standard EN15940 mixed with a biofuel that meets standard EN14214 (possibly containing up to 7% Fatty Acid Methyl Ester).

A square label with a black border containing the text "B20" in bold black font.A square label with a black border containing the text "B30" in bold black font.

The use of B20 or B30 fuel meeting standard EN16709 is possible in your diesel engines. However, this use, even occasional, requires strict

application of the special servicing conditions referred to as "Arduous conditions".

For more information, contact a dealer or a qualified workshop.

**Caution**

The use of any other type of (bio) fuel (vegetable or animal oils, pure or diluted, domestic fuel etc.) is strictly prohibited (risk of damage to the engine and fuel system).

**Notice**

The only diesel additives authorised for use are those that meet the B715000 standard.

Vehicles with diesel engine operating in Ecuador require the additive **DLP 32-600** to avoid damage of the injection system. This additive can only be purchased at Opel dealers. The additive has to be poured into the tank before refilling Diesel. For each 50 litres of Diesel refilled, 30 millilitres of additive have to be added. To dose

the additive, use the cap of the additive can. The cap allows a dose of 30 millilitres.

**Low temperature operation**

At temperatures below 0 °C, some diesel products with biodiesel blends may clog, freeze or gel, which may affect the fuel supply system. Starting and engine operation may not work properly. Make sure to fill winter grade diesel fuel at ambient temperatures below 0 °C.

Arctic grade diesel fuel can be used at extremely low temperatures below -20 °C. Using this fuel grade in warm or hot climates is not recommended and may cause engine stalling, poor starting or damage on the fuel injection system.

**Refuelling**

**⚠ Danger**

Before refuelling, switch off ignition and any external heaters with combustion chambers.

Follow the operating and safety instructions of the filling station when refuelling.

**⚠ Danger**

Fuel is flammable and explosive. No smoking. No naked flames or sparks.

If you can smell fuel in your vehicle, have the cause of this remedied immediately by a workshop.

A label with symbols at the fuel filler flap is indicating the allowed fuel types. In Europe the pump nozzles of the filling stations are marked with these symbols. Refuel only the allowed fuel type.

**Caution**

In case of misfuelling, do not switch on ignition.

Fuel filler flap is located at left rear side of vehicle.



If the vehicle is equipped with an electronic key system, the fuel filler flap can only be opened if the vehicle is unlocked. Depending on the version, release the fuel filler flap by pushing the flap or pulling at the right bottom corner.

### **Petrol and diesel refuelling**

Depending on the version, place the key in the lock and unlock the cap.

To open, turn the cap slowly anticlockwise.



The fuel filler cap can be attached to the hook on the fuel filler flap.

Place the nozzle in straight position to the filler neck and press with slight force to insert.

To refuel, switch on pump nozzle.

After the automatic cut-off, the tank can be topped up by operating the pump nozzle a maximum of two more times.

### **Caution**

Wipe off any overflowing fuel immediately.

To close, turn the fuel filler cap clockwise until it clicks.

Close the flap and allow it to engage.

### **Fuel filler cap**

Only use genuine fuel filler caps.

Diesel-engined vehicles have special fuel filler caps.

## Trailer hitch

### General information

Only use towing equipment that has been approved for your vehicle.

Entrust retrofitting of towing equipment to a workshop. It may be necessary to make changes that affect the cooling system, heat shields or other equipment.

The bulb outage detection function for trailer brake light cannot detect a partial bulb outage e.g. in case of four bulbs with a power of 5 W each, the function only detects lamp outage when only a single 5 W lamp remains or none remain.

Fitting of towing equipment could cover the opening of the towing eye. If this is the case use the coupling ball bar for towing. Always keep the coupling ball bar in the vehicle to have it on hand if needed.

### Driving characteristics and towing tips

Before attaching a trailer, lubricate the coupling ball. However, do not do so if a stabiliser, which acts on the coupling ball, is being used to reduce snaking movements.

During trailer towing do not exceed a speed of 50 mph. A maximum speed of 60 mph is only appropriate if an oscillation damper is used and the permissible gross trailer weight does not exceed the vehicle's curb weight.

For trailers with low driving stability and caravan trailers, the use of an oscillation damper is strongly recommended.

If the trailer starts snaking, drive more slowly, do not attempt to correct the steering and brake sharply if necessary.

When driving downhill, drive in the same gear as if driving uphill and drive at a similar speed.

Adjust tyre pressure to the value specified for full load ↗ 263.

### Trailer towing

#### Trailer loads

The permissible trailer loads are vehicle and engine-dependent maximum values which must not be exceeded. The actual trailer load is the difference between the actual gross weight of the trailer and the actual coupling socket load with the trailer coupled.

The permissible trailer loads are specified in the vehicle documents. In general, they are valid for inclines up to 12%.

The permissible trailer load applies up to the specified incline and at sea level. Since engine power decreases as altitude increases due to the air becoming thinner, therefore reducing climbing ability, the permissible gross train weight also decreases by 10% for every 1000 metres of altitude. The gross train weight does not have to be reduced when driving on roads with slight inclines (less than 8%, e.g. motorways).



The permissible gross train weight must not be exceeded. This weight is specified on the identification plate  
 ⇨ 256.

### Vertical coupling load

The vertical coupling load is the load exerted by the trailer on the coupling ball. It can be varied by changing the weight distribution when loading the trailer.

The maximum permissible vertical coupling load is specified on the towing equipment identification plate and in the vehicle documents.

Always aim for the maximum vertical coupling load, especially in the case of heavy trailers. The vertical coupling load should never fall below 25 kg.

### Rear axle load

When the trailer is coupled and the towing vehicle fully loaded, the permissible rear axle load (see identification plate or vehicle documents) may be exceeded by 60 kg, the gross vehicle weight rating must not be exceeded. If the

permissible rear axle load is exceeded, a maximum speed of 60 mph applies.

### Towing equipment

Depending on version the vehicle can be fitted with a detachable or a fixed coupling ball bar.

#### Type A

Caution
When operating without a trailer, remove the coupling ball bar.

#### Fitting the coupling ball bar

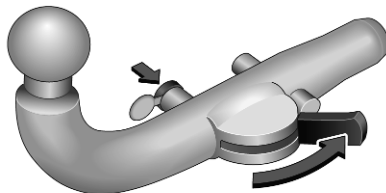

1. Place the key in the lock and unlock the coupling ball bar. Move the lever to the rear position.



2. Clean the contact points with a soft clean cloth.



3. Insert the coupling ball bar in the opening and push firmly up to the stop.

Secure the coupling ball bar correctly by moving the lever to the locked position, shown in the picture.

4. Lock the coupling ball bar by turning the key. Remove the key and close the protective flap.
5. Attach the trailer.
6. Fold the socket forward.

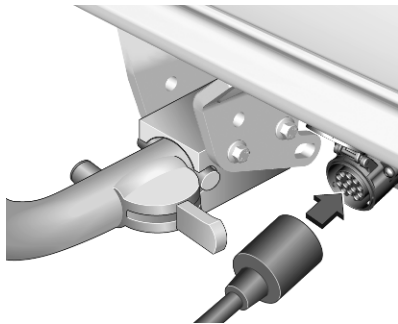

7. Connect the trailer plug to the socket.

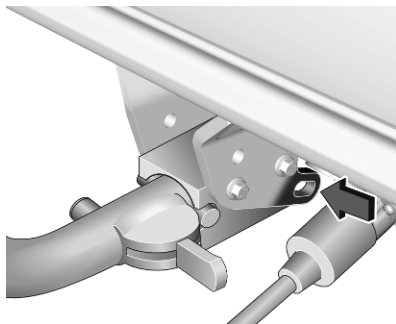

8. Attach the breakaway stopping cable to the eye on the carrier.

**⚠ Warning**

Towing a trailer is permitted only when a coupling ball bar is fitted correctly. If the coupling ball bar does not engage correctly, seek the assistance of a workshop.

**Dismounting coupling ball bar**

1. Disconnect the trailer plug.
2. Unfasten the breakaway stopping cable.
3. Remove the trailer.

4. Open the protective flap and unlock the coupling ball bar with the key.



5. Move the lever of the coupling ball bar to the rear position. Remove the coupling ball bar by pulling it.

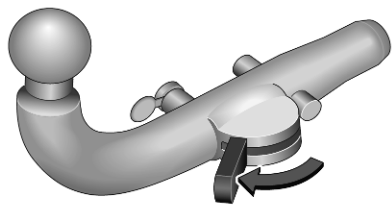

6. Move the lever of the coupling ball bar to the front position.

### Type B

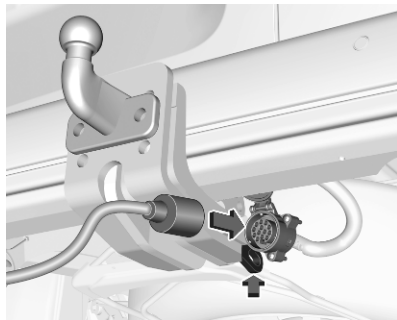

1. Connect the trailer plug to the socket and fasten the breakaway stopping cable to the eye on the carrier.
2. Attach the trailer.

### Type C

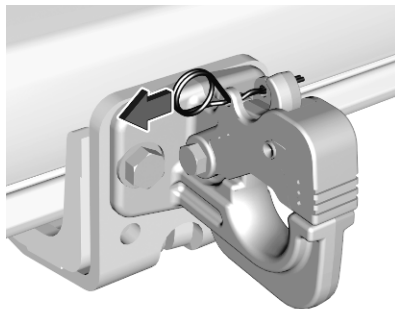

1. Remove the safety splint.

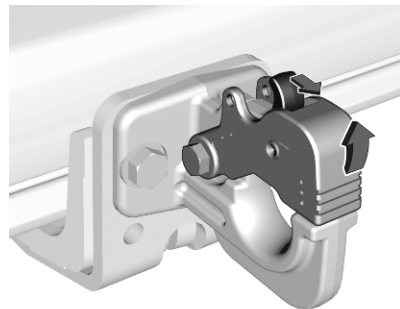

2. Pull the lever and open the towing ring.
3. Attach the trailer, close the towing ring and fix the splint.

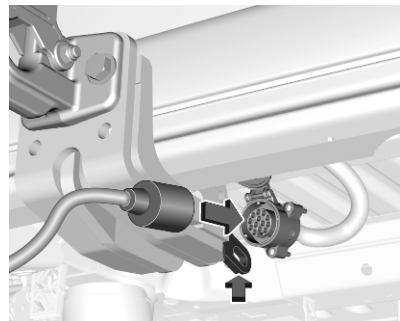

4. Connect the trailer plug to the socket and attach the breakaway stopping cable to the eye on the carrier.

### **Trailer stability assist**

If the system detects snaking movements, engine power is reduced and the vehicle / trailer combination is selectively braked until the snaking ceases. While system is working keep steering wheel as still as possible.

Trailer stability assist is a function of the Electronic Stability Control ↪ 163.

## Vehicle care

<b>General Information</b> .....	<b>211</b>
Accessories and vehicle modifications .....	211
Vehicle storage .....	212
End-of-life vehicle recovery .....	213
<b>Vehicle checks</b> .....	<b>213</b>
Performing work .....	213
Bonnet .....	213
Engine oil .....	214
Engine coolant .....	215
Washer fluid .....	216
Brakes .....	216
Brake fluid .....	216
Vehicle battery .....	217
Diesel fuel system bleeding .....	219
Wiper blade replacement .....	219
<b>Bulb replacement</b> .....	<b>220</b>
Halogen headlights .....	220
LED headlights .....	222
Front fog lights .....	222
Front turn lights .....	223
Tail lights .....	224
Side turn lights .....	226
Number plate light .....	227
Interior lights .....	227

<b>Electrical system</b> .....	<b>227</b>
Fuses .....	227
Engine compartment fuse box .....	228
Instrument panel fuse box .....	229
<b>Vehicle tools</b> .....	<b>230</b>
Tools .....	230
<b>Wheels and tyres</b> .....	<b>231</b>
Winter tyres .....	231
Tyre designations .....	231
Tyre pressure .....	232
Tyre deflation detection system .....	233
Tread depth .....	234
Changing tyre and wheel size .....	234
Wheel covers .....	235
Tyre chains .....	235
Tyre repair kit .....	235
Wheel changing .....	238
Spare wheel .....	240
<b>Jump starting</b> .....	<b>243</b>
<b>Towing</b> .....	<b>245</b>
Towing the vehicle .....	245
Towing another vehicle .....	246
<b>Appearance care</b> .....	<b>247</b>
Exterior care .....	247
Interior care .....	249
Floor mats .....	249

## General Information

### Accessories and vehicle modifications

We recommend the use of genuine parts and accessories and factory approved parts specific for your vehicle type. We cannot assess or guarantee reliability of other products - even if they have a regulatory or otherwise granted approval.

Any modification, conversion or other changes made to standard vehicle specifications (including, without limitation, software modifications, modifications of the electronic control units) may invalidate the warranty offered by Vauxhall. Furthermore, such changes may affect driver assistance systems, may impact fuel consumption, CO<sub>2</sub> emissions and other emissions of the vehicle and cause the vehicle to no longer conform to the operating permit, impacting the validity of your vehicle registration.

**Caution**

When transporting the vehicle on a train or on a recovery vehicle, the mud flaps might be damaged.

**Cold protection covers**

In order to prevent the accumulation of snow at the radiator cooling fan, it is recommended to install removable protection covers.

The protection covers must be professionally installed, consult a workshop.

**Caution**

The protection covers must be removed when one of the following conditions occurs:

- The ambient temperature is above 10 °C.
- When the vehicle is towed.
- The vehicle is driven at speeds above 75 mph.

**Vehicle storage****Storage for a long period of time**

If the vehicle is to be stored for several months:

- Wash and wax the vehicle.
- Have the wax in the engine compartment and underbody checked.
- Clean and preserve the rubber seals.
- Fill up fuel tank completely.
- Change the engine oil.
- Drain the washer fluid reservoir.
- Check the coolant antifreeze and corrosion protection.
- Adjust tyre pressure to the value specified for full load.
- Park the vehicle in a dry, well ventilated place. Engage first or reverse gear or set selector lever to **P**. Prevent the vehicle from rolling.
- Do not apply the parking brake.

- Open the bonnet, close all doors and lock the vehicle.
- Disconnect the clamp from the negative terminal of the vehicle battery. Note that all systems are not functional, e.g. anti-theft alarm system.

**Putting back into operation**

When the vehicle is to be put back into operation:

- Connect the clamp to the negative terminal of the vehicle battery. Initialize the power windows ↻ 40.
- Check tyre pressure.
- Fill up the washer fluid reservoir.
- Check the engine oil level.
- Check the coolant level.
- Fit the number plate if necessary.

## End-of-life vehicle recovery

Information on end-of-life vehicle recovery centres and the recycling of end-of-life vehicles is available on our website, where legally required. Only entrust this work to an authorised recycling centre.

## Vehicle checks

### Performing work

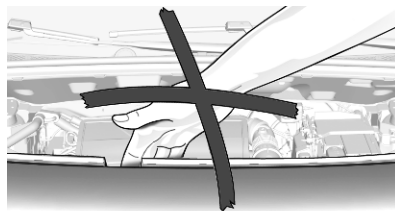

### ⚠ Warning

Only perform engine compartment checks when the ignition is off.  
The cooling fan may start operating even if the ignition is off.

### ⚠ Danger

The ignition system uses extremely high voltage. Do not touch.

## Bonnet

### Opening

Open the driver's door.

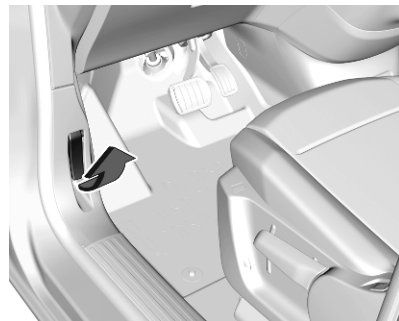

Pull the release lever and return it to its original position.

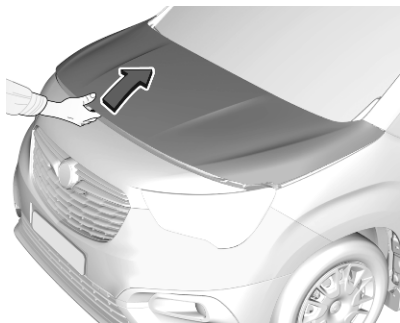

Push the safety catch upwards and open the bonnet.

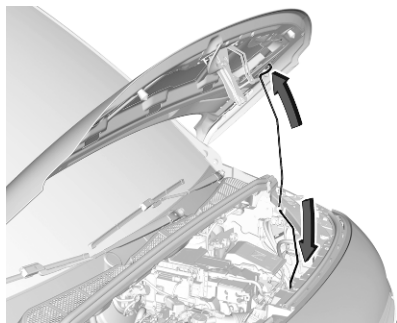

Secure the bonnet support.

### Closing

Before closing the bonnet, press the support into the holder.

Lower the bonnet and let it fall into the latch from a low height (20-25 cm). Check that the bonnet is engaged.

### Caution

Do not press the bonnet into the latch to avoid dents.

### Engine oil

Check the engine oil level manually on a regular basis to prevent damage to the engine. Ensure that the correct specification of engine oil is used.

Recommended fluids and lubricants  
◇ 254.

The maximum engine oil consumption is 0.6 l per 600 miles.

Check with the vehicle on a level surface. The engine must be at operating temperature and switched off for at least 5 min.

### Caution

It is the owner's responsibility to maintain the proper level of an appropriate quality engine oil in the engine.

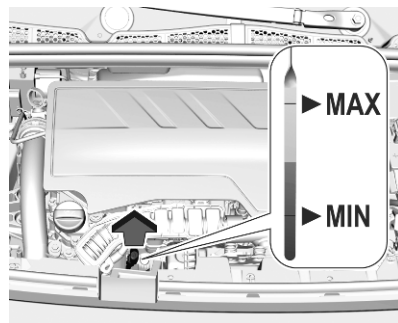

Pull out the dipstick, wipe it clean, reinsert it fully, pull out and read the engine oil level.



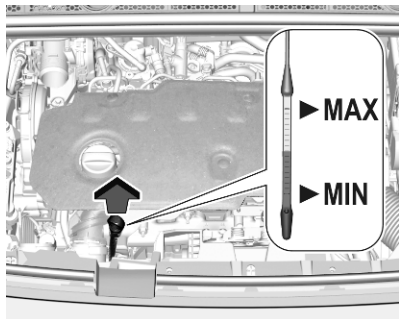

Different dipsticks are used depending on engine variant.

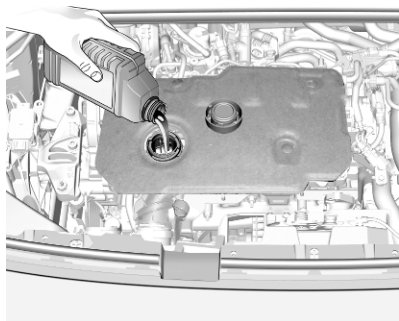

When the engine oil level has dropped to the **MIN** mark, top up the engine oil.

We recommend the use of the same grade of engine oil that was used at last change.

The engine oil level must not exceed the **MAX** mark on the dipstick.

### Caution

Overfilled engine oil must be drained or suctioned out. If the engine oil exceeds the maximum level, do not start the vehicle and contact a workshop.

Capacities ⇨ 263.

Fit the cap on straight and tighten it.

### Engine coolant

The factory filled coolant provides freeze protection down to approx. -37 °C.

### Caution

Only use approved antifreeze.

Coolant and antifreeze ⇨ 254.

### Coolant level

#### Caution

Too low a coolant level can cause engine damage.

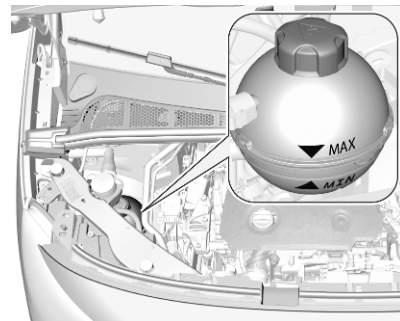

If the cooling system is cold, the coolant level should be above the **MIN** mark. Top up if the level is low.

**⚠ Warning**

Allow the engine to cool before opening the cap. Carefully open the cap, relieving the pressure slowly.

To top up, use a 1:1 mixture of released coolant concentrate mixed with clean tap water. If no coolant concentrate is available, use clean tap water. Install the cap tightly. Have the coolant concentration checked and have the cause of the coolant loss remedied by a workshop.

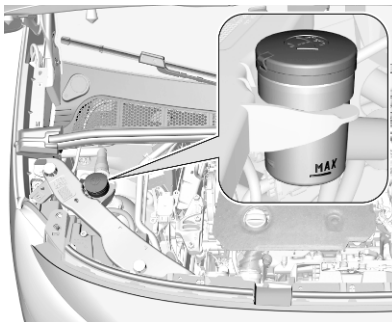
**Washer fluid**

Fill with clean water mixed with a suitable quantity of approved windscreen washer fluid which contains antifreeze.

The washer fluid level has to be underneath the **MAX** mark.

**Caution**

Only washer fluid with a sufficient antifreeze concentration provides protection at low temperatures or a sudden drop in temperature.

Washer fluid ⇨ 254.

**Brakes**

In the event of minimum thickness of the brake lining, a squealing noise sounds during braking.

Continued driving is possible but have the brake lining replaced as soon as possible.

Once new brake linings are installed, do not brake unnecessarily hard for the first few journeys.

**Brake fluid****⚠ Warning**

Brake fluid is poisonous and corrosive. Avoid contact with eyes, skin, fabrics and painted surfaces.

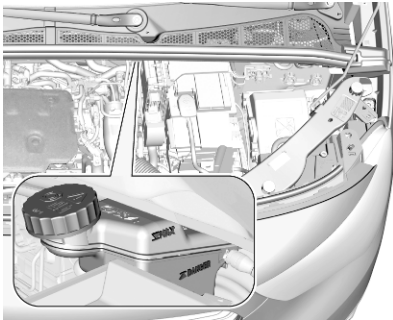

The brake fluid level must be between the **DANGER** and **MAX** marks.

If fluid level is below **DANGER**, seek the assistance of a workshop.

Brake and clutch fluid ↻ 254.

## Vehicle battery

The vehicle battery is maintenance-free provided that the driving profile allows sufficient charging of the battery. Short-distance-driving and frequent engine starts can discharge the battery. Avoid the use of unnecessary electrical consumers.



Batteries do not belong in household waste. They must be disposed of at an appropriate recycling collection point.

Laying up the vehicle for more than four weeks can lead to battery discharge. Disconnect the clamp from the negative terminal of the vehicle battery.

Ensure the ignition is switched off before connecting or disconnecting the vehicle battery.

Battery discharge protection ↻ 129.

## Replacing the vehicle battery

### Notice

Any deviation from the instructions given in this section may lead to temporary deactivation or disturbance of the stop-start system.

When the vehicle battery is being replaced, please ensure that there are no open ventilation holes in the vicinity of the positive terminal. If a ventilation hole is open in this area, it must be closed off with a dummy cap, and the ventilation in the vicinity of the negative terminal must be opened.

Ensure that the battery is always replaced by the same type of battery.

The vehicle battery has to be replaced by a workshop.

Stop-start system ↻ 147.

## Charging the vehicle battery

### ⚠ Warning

On vehicles with stop-start system, ensure that the charging potential does not exceed 14.6 V when using a battery charger. Otherwise the vehicle battery may be damaged.

Jump starting ↻ 243.

## Discharge protection

### Battery voltage

When the vehicle battery voltage is running low, a warning message will appear in the Driver Information Centre.

When the vehicle is being driven, the load reduction function temporarily deactivates certain functions, e.g. the heated rear window.

The deactivated functions are reactivated automatically as soon as conditions permit.

### Idle boost

If charging of the vehicle battery is required due to battery condition, the power output of the generator must be increased. This will be achieved by an idle boost which may be audible.

A message appears in the Driver Information Centre.

### Power outlet

The power outlets are deactivated in the event of low vehicle battery voltage.

## Warning label



### Meaning of symbols:

- No sparks, naked flames or smoking.
- Always shield eyes. Explosive gases can cause blindness or injury.
- Keep the vehicle battery out of reach of children.
- The vehicle battery contains sulphuric acid which could cause blindness or serious burn injuries.

- See the Owner's Manual for further information.
- Explosive gas may be present in the vicinity of the vehicle battery.

## Power saving mode

This mode deactivates electrical consumers to avoid excessive discharging of the vehicle battery. These consumers, such as the infotainment system, windscreen wipers, low beam headlights, courtesy light, etc. can be used for a total maximum time of about 40 minutes after ignition is switched off.

### Changing into power saving mode

When power saving mode is activated, a message appears in the Driver Information Centre indicating **Power saving mode**.

An active telephone call using the hands-free option will be maintained for around 10 minutes longer.

### Deactivating power saving mode

Power saving mode is deactivated automatically when the engine is restarted. Run the engine for a sufficient charge:

- for less than 10 minutes to use the consumers for approx. 5 minutes
- for more than 10 minutes to use the consumers for up to approx. 30 minutes

### Diesel fuel system bleeding

If the tank has been run dry, the diesel fuel system must be bled. Switch on the ignition three times for 15 seconds at a time. Then crank the engine for a maximum of 40 seconds. Repeat this process after no less than five seconds. If the engine fails to start, seek the assistance of a workshop.

## Wiper blade replacement

### Windscreen

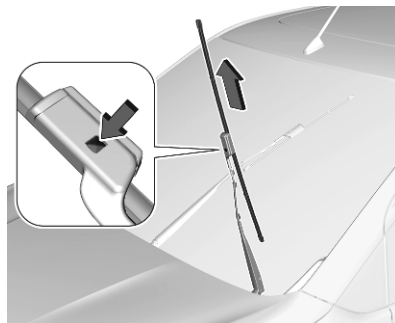

Switch off the ignition.

Within one minute after switching off the ignition, operate the wiper lever to position the wiper blades vertically on the windscreen.

Lift the wiper arm until it stays in the raised position, press button to disengage the wiper blade and remove.

Attach the wiper blade to the wiper arm and push until it engages.

Lower the wiper arm carefully.

### Rear window



Lift the wiper arm. Disengage the wiper blade as shown in the illustration and remove.

Attach the wiper blade slightly angled to the wiper arm and push until it engages.

Lower the wiper arm carefully.

## Bulb replacement

Before replacing a bulb, ensure that all exterior and interior lights and the ignition are switched off. All doors have to be closed.

Only hold a new bulb at the base. Do not touch the bulb glass with bare hands.

Use only the same bulb type for replacement.

Replace headlight bulbs from within the engine compartment.

### Bulb check

After a bulb replacement switch on the ignition, operate and check the lights.

### Halogen headlights

Halogen headlights with separate bulbs for low beam and high beam.

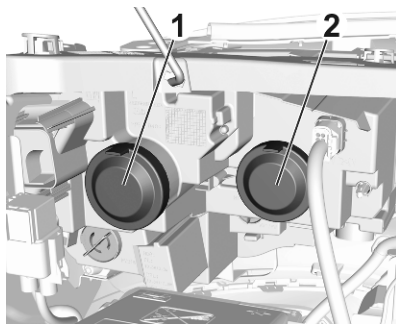

Low beam (1) outer bulb  
High beam (2) inner bulb

### Low beam (1)

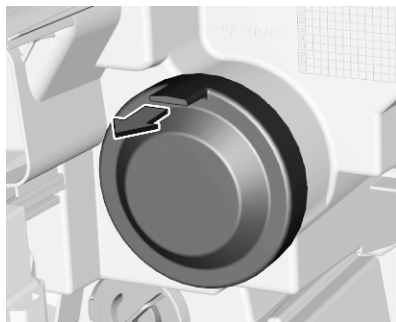

1. Remove the protective cover by pulling.

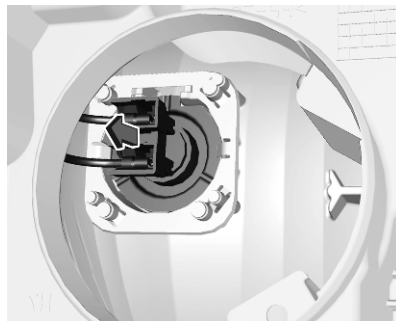

2. Withdraw the bulb socket from the reflector housing.

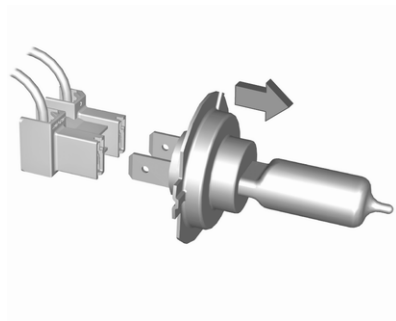

3. Detach the bulb from the bulb socket and replace the bulb.
4. Insert the bulb socket into the reflector housing.
5. Fit the protective cover on.

### High beam (2)

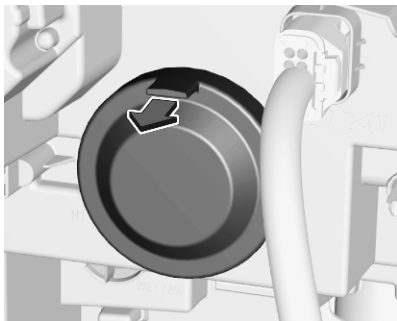

1. Remove the protective cover by pulling.



2. Disengage the spring clip from the retainer by moving it to the righthand side. Swivel the spring clip downwards.

Withdraw the bulb socket from the reflector housing.

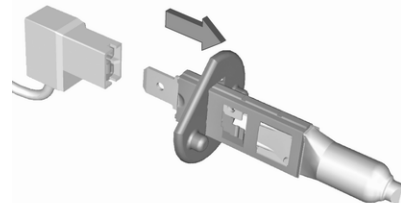

3. Detach the bulb from the bulb socket and replace the bulb.
4. Insert the bulb socket into the reflector housing.
5. Fit the protective cover on.

### Sidelight / daytime running light with bulbs

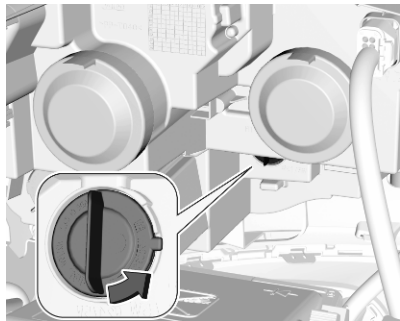

1. Rotate the bulb socket anticlockwise to disengage and withdraw from the reflector.

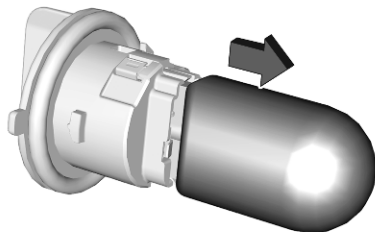

2. Remove the bulb from the bulb socket by pulling.
3. Replace and insert the new bulb into the bulb socket.
4. Insert the bulb socket into the light assembly and turn clockwise.

### Sidelight / daytime running light with LEDs

In case of defective LEDs, have them replaced by a workshop.

### LED headlights

Daytime running lights are designed as LEDs and can not be changed.

Have lights repaired by a workshop in case of failure.

### Front fog lights



1. Wrap a cloth around the tip of a flat screwdriver to prevent paint damage. Insert the screwdriver in the recess at the edge of the cover. Release the cover by levering it out carefully.



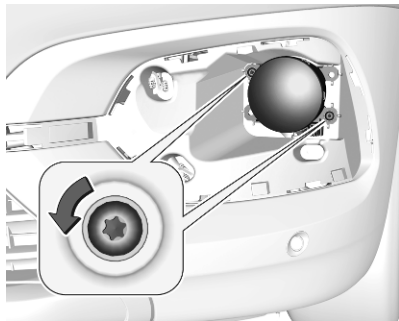

2. Unscrew and remove the two screws and remove the light assembly to the front.

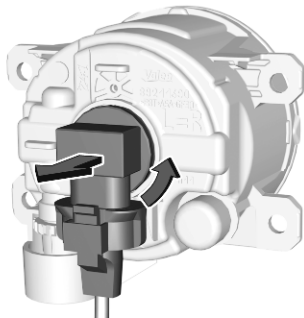

3. Turn the bulb socket anticlockwise and remove it from the light assembly.

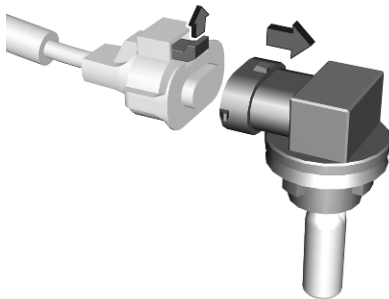

4. Disengage the plug connector by pulling the retaining lug.
5. Remove and replace the bulb unit and attach the plug connector. Note that the bulb and the socket are one unit and have to be changed together.
6. Insert the bulb socket into the light assembly by turning clockwise and engage.
7. Mount the light assembly by tightening the two screws.
8. Attach and engage the cover.

## Front turn lights

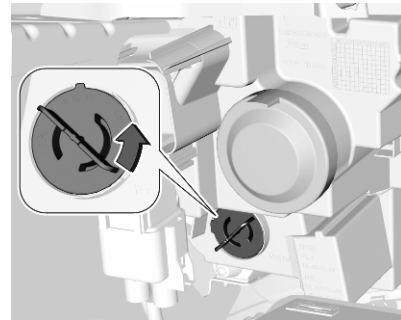

1. Rotate the bulb socket anticlockwise to disengage and withdraw from the reflector.

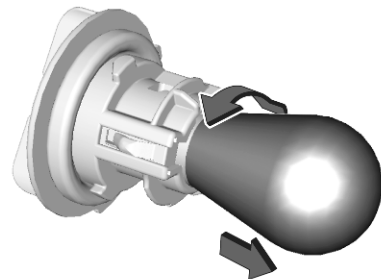

2. Slightly press down the bulb, turn it anticlockwise and remove it from the socket.
3. Replace and insert the new bulb into socket by turning clockwise.
4. Insert the bulb socket into the reflector and turn clockwise.

## Tail lights

### Light assembly in the body

#### Vehicle with tailgate

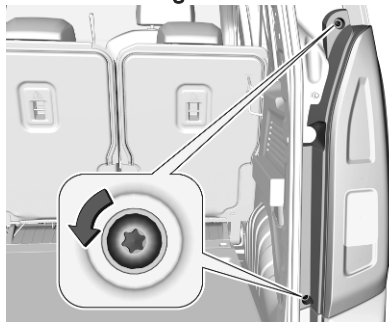

1. Unscrew and remove the two screws.

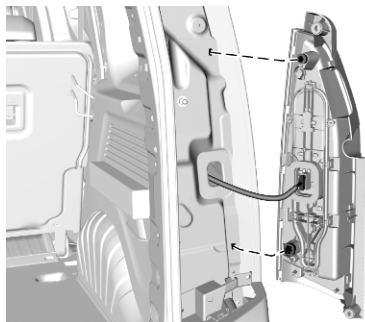

2. Carefully withdraw the tail light assembly from recess and remove. Take care that the cable duct remains in position.
3. Detach the cable from the retainer.

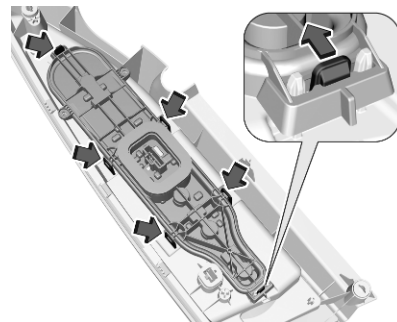

4. Press the retaining lug backwards, pull the bulb carrier and disengage the remaining retaining lugs.

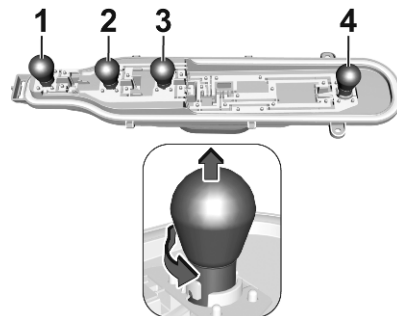

5. Push the bulb slightly down, turn it and remove it from the bulb carrier. Replace the bulb:
  - Rear fog light (1)
  - Reversing light (2)
  - Turn light / hazard warning flasher (3)
  - Tail light / brake light (4)
6. Attach the bulb carrier to the light assembly.
7. Attach the cable to the retainer.
8. Attach the light assembly to the vehicle body and tighten both screws.

#### Vehicle with rear doors

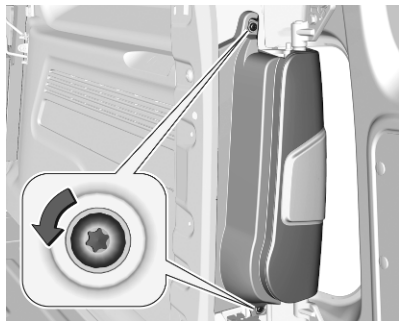

1. Unscrew and remove the two screws.

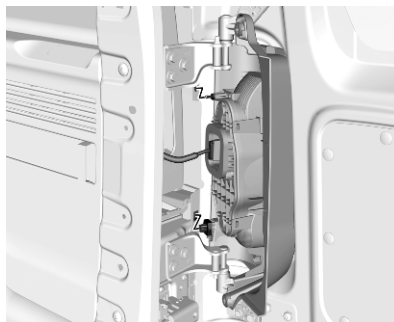

2. Carefully withdraw the tail light assembly from recess and remove. Take care that the cable duct remains in position.
3. Detach the cable from the retainer.

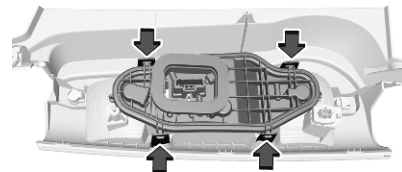

4. Disengage the retaining lugs to remove the bulb carrier.

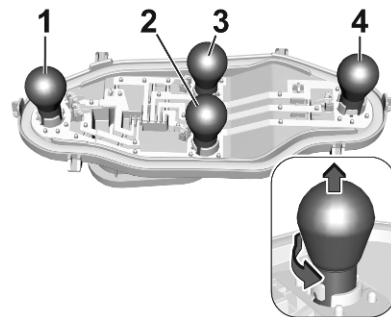

5. Push the bulb slightly down, turn it and remove it from the bulb carrier. Replace the bulb:

Tail light / brake light (1)

Turn light / hazard warning flasher (2) outer bulb

Reversing light (3) inner bulb

Rear fog light (4)

6. Attach the bulb carrier to the light assembly.
7. Attach the cable to the retainer.
8. Attach the light assembly to the vehicle body and tighten both screws.

### 3rd-brake light

The 3rd-brake light is designed as LED and can not be changed.

Have lights repaired by a workshop in case of failure.

### Bulb check

Switch on the ignition, operate and check all lights.

### Side turn lights

To replace the bulb, remove the lamp housing:

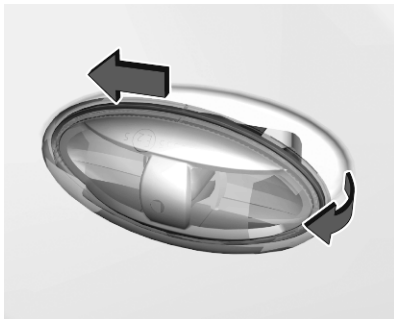

1. Slide the lamp housing forward and remove it at the back.

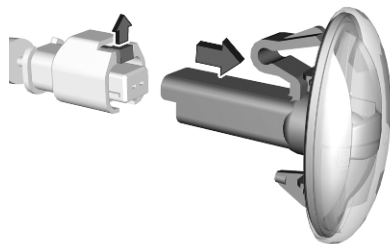

2. Press the retaining lug upwards and remove the bulb socket from the plug connector.
3. Replace the complete unit.
4. Insert left end of the lamp, slide to the left and insert right end.

## Number plate light



1. Insert a screwdriver in the recess of the cover and remove it.



2. Pull the bulb from the bulb holder and replace it.
3. Attach the cover.

## Interior lights

Have the following bulbs replaced by a workshop:

- courtesy light, reading lights
- load compartment light
- instrument panel illumination

## Electrical system

### Fuses

Data on the replacement fuse must match the data on the defective fuse.

There are two fuse boxes in the vehicle:

- engine compartment
- instrument panel

Before replacing a fuse, turn off the respective switch and the ignition.

A blown fuse can be recognised by its melted wire.

### Caution

Do not replace the fuse until the cause of the fault has been remedied.

Some functions are protected by several fuses.

Fuses may also be inserted without existence of a function.

## Fuse extractor

A fuse extractor may be located in the fuse box in the engine compartment. The extractor has two sides, each side is designed for a different type of fuses.

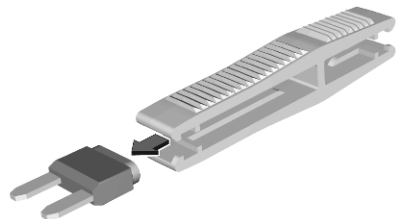

Grab the fuse with the fuse extractor and withdraw the fuse.

## Engine compartment fuse box

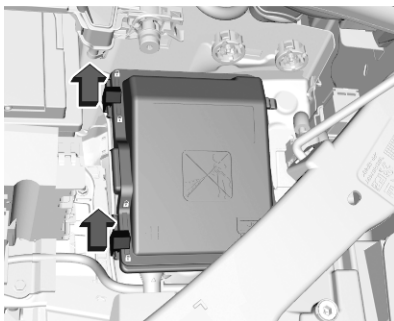

The fuse box is in the front left of the engine compartment.  
Disengage the cover and remove it.



No.	Circuit
-----	---------

- |    |                  |
|----|------------------|
| 16 | Front fog lights |
| 18 | Right headlight  |
| 19 | Left headlight   |
| 29 | Windscreen wiper |

After having changed defective fuses, close the fuse box cover and lock it.

If the fuse box cover is not closed correctly, malfunction may occur.

## Instrument panel fuse box

The fuse box is located behind a cover in the instrument panel at the left side.

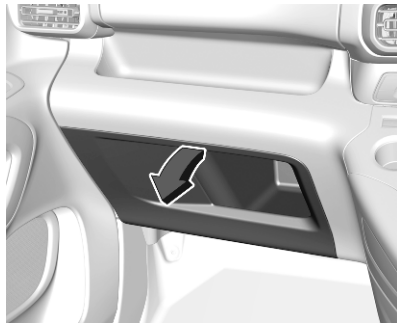

Remove the cover by pulling at the top left, then at the right side.

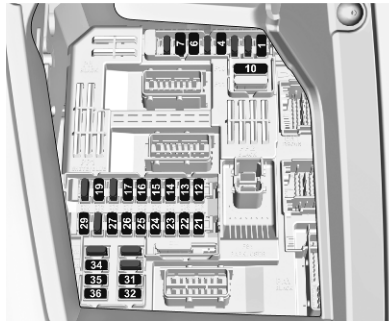

### No. Circuit

- 1 Inductive charging, clutch switch, selective ride control, power steering, diesel exhaust system, interior mirror
- 4 Horn
- 6 Windscreen washer
- 7 Power outlet rear
- 10 Door lock
- 12 Diagnostic connector, power supply transformer

### No. Circuit

- 13 Head-up display, climate control, Infotainment system
- 14 Anti-theft alarm system, tele-matic unit
- 15 Automatic transmission, instrument cluster, climate control
- 16 Starter, power supply transformer
- 17 Instrument cluster
- 19 Trailer socket, steering wheel controls
- 21 Anti-theft system, power button
- 22 Rear view camera, rain and light sensor
- 23 Seat belt reminder, special vehicle control module, start-stop, trailer socket
- 24 Parking assist, Infotainment system, rear view camera, side blind spot camera
- 25 Airbag

**No. Circuit**

- 26 Steering angle sensor
- 27 Parking heater
- 29 Infotainment system
- 31 -
- 32 Power outlet
- 34 Parking assist, interior mirror
- 35 Diagnostic connector, headlight range adjustment, heated wind-screen, climate control
- 36 Interior lights, USB port

## Vehicle tools

### Tools

#### Vehicles with spare wheel

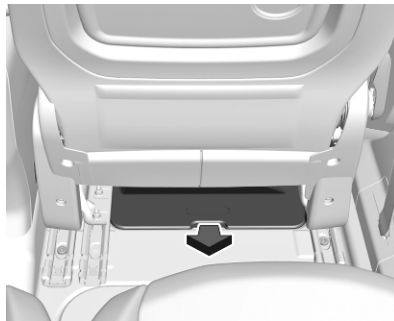

Open the cover of the footwell storage  
↗ 73.

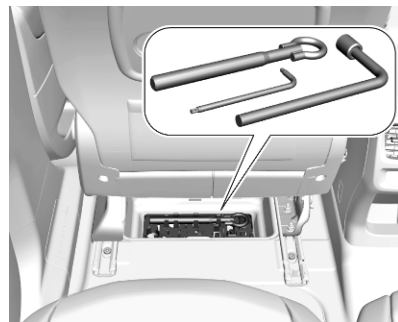

The towing eye and the tools are located in the storage compartment underneath the left front seat.

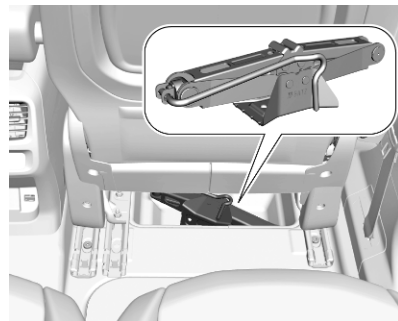



The jack is located in the stowage compartment underneath the right front seat.

### Vehicles without spare wheel

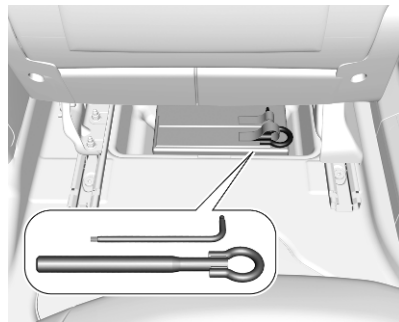

The towing eye and the tools are located in the stowage compartment underneath the right front seat.

Tyre repair kit ⇨ 235.

## Wheels and tyres

### Tyre condition, wheel condition

Drive over edges slowly and at right angles if possible. Driving over sharp edges can cause tyre and wheel damage. Do not trap tyres on the kerb when parking.

Regularly check the wheels for damage. Seek the assistance of a workshop in the event of damage or unusual wear.

### Winter tyres

Winter tyres improve driving safety at temperatures below 7 °C and should therefore be fitted on all wheels.

In accordance with country-specific regulations, affix the speed sticker in the driver's field of view.

All tyre sizes are permitted as winter tyres ⇨ 263.

## Tyre designations

E.g. **225/55 R 18 98 V**

**225** : tyre width, mm

**55** : cross-section ratio (tyre height to tyre width), %

**R** : belt type: Radial

**RF** : type: RunFlat

**18** : wheel diameter, inches

**98** : load index e.g. 98 is equivalent to 750 kg

**V** : speed code letter

Speed code letter:

**Q** : up to 100 mph

**S** : up to 112 mph

**T** : up to 118 mph

**H** : up to 130 mph

**V** : up to 150 mph

**W** : up to 168 mph

Choose a tyre appropriate for the maximum speed of your vehicle. Refer to the EEC Certificate of Conformity provided with your vehicle or other national registration documents. Optional equipment could reduce the maximum speed of the vehicle.

## Directional tyres

Directional tyres should be mounted so that they rotate in the correct direction. The proper rotation direction is indicated by a symbol (e.g. an arrow) on the sidewall.

## Tyre pressure

Check the pressure of cold tyres at least every 14 days and before any long journey. Do not forget the spare wheel. This also applies to vehicles with tyre pressure monitoring system.



Tyre pressure ⇨ 263.

The tyre pressure information label on the left door frame indicates the original equipment tyres and the correspondent tyre pressures.

The tyre pressure data refers to cold tyres. It applies to summer and winter tyres.

Always inflate the spare tyre to the pressure specified for full load.

Incorrect tyre pressures will impair safety, vehicle handling, comfort and fuel economy and will increase tyre wear.

Tyre pressures differ depending on various options. For the correct tyre pressure value, follow the procedure below:

1. Identify the engine identifier code.  
Engine data ⇨ 260.
2. Identify the respective tyre.

The tyre pressure tables show all possible tyre combinations ⇨ 263.

For the tyres approved for your vehicle, refer to the EEC Certificate of Conformity provided with your vehicle or other national registration documents.

The driver is responsible for correct adjustment of tyre pressure.

### ⚠ Warning

If the pressure is too low, this can result in considerable tyre warm-up and internal damage, leading to tread separation and even to tyre blow-out at high speeds.

### ⚠ Warning

For specific tyres the recommended tyre pressure as shown in the tyre pressure table may exceed the maximum tyre pressure as indicated on the tyre. Never exceed the maximum tyre pressure as indicated on the tyre.

## Temperature dependency

The tyre pressure depends on the temperature of the tyre. During driving, tyre temperature and pressure increase. Tyre pressure values provided on the tyre

information label and tyre pressure chart are valid for cold tyres, which means at 20 °C.

The pressure increases by nearly 1.5 psi for a 10 °C temperature increase. This must be considered when warm tyres are checked.

## Tyre deflation detection system

The tyre deflation detection system continually checks the rotation speed of all four wheels and warns on low tyre pressure condition once vehicle is driving. This is achieved by comparing tyre rolling circumference with reference values and further signals.

If a tyre loses pressure the control indicator (⚠) illuminates, a warning chime is given and a warning message is displayed in the Driver Information Centre.

In this case reduce speed, avoid sharp cornering and strong braking. Stop at next safe opportunity and check tyre pressure.

Control indicator (⚠) ⇨ 105.

After adjusting tyre pressure initialise system to extinguish the control indicator and restart system.

### Caution

Deflation detection system warns just about low tyre pressure condition and does not replace regular tyre maintenance by the driver.

In case of a system malfunction a message is displayed in the Driver Information Centre. Set correct tyre pressure and reinitialise system. If the failure continues to be displayed, contact a workshop. The system is inoperable when ABS or ESC has a malfunction or a temporary spare wheel is used. Once the road tyre has been refitted, check the tyre pressure with cold tyres and initialise the system.

### System initialisation

After tyre pressure correction or wheel change, the system must be initialised to learn new circumference reference values:

1. Always ensure that all four tyres have correct tyre pressure ⇨ 263.
2. Apply parking brake.



3. Initialise the deflation detection system: If the vehicle has a graphic info display, press  $\text{⚠}_{\text{SET}}$  for three seconds. If the vehicle has a colour info display, the initialisation is done in the vehicle personalisation ⇨ 115.
4. Reset is confirmed by pop-up indication.

After initialisation system automatically calibrates to new tyre pressures during driving. After longer drive the system will adopt and monitor new pressures.

Always check tyre pressure with cold tyres.

System has to be reinitialised when:

- Tyre pressure has been changed
- Load condition has been changed
- Wheels have been swapped or exchanged

The system will not warn instantaneously on a tyre blow out or a rapid deflation. This is due to required calculation time.

## Tread depth

Check tread depth at regular intervals.

Tyres should be replaced for safety reasons at a tread depth of 2-3 mm (4 mm for winter tyres).

For safety reasons, it is recommended that the tread depth of the tyres on one axle should not vary by more than 2 mm.



The legally permissible minimum tread depth (1.6 mm) has been reached when the tread has worn down as far as one of the tread wear indicators (TWI). Their position is indicated by markings on the sidewall.

If there is more wear at the front than the rear, swap round front wheels and rear wheels periodically. Ensure that the direction of rotation of the wheels remains the same.

Tyres age, even if they are not used. We recommend tyre replacement every six years.

## Changing tyre and wheel size

If tyres of a different size than those fitted at the factory are used, it may be necessary to reprogramme the tyre deflation detection system and make other vehicle modifications.

Tyre deflation detection system  
↪ 233.

Have the label with tyre pressures replaced.

### Warning

The use of unsuitable tyres or wheels may lead to accidents and will invalidate the vehicle operating permit.

## Wheel covers

Wheel covers and tyres that are factory approved for the respective vehicle and comply with all of the relevant wheel and tyre combination requirements must be used.

If the wheel covers and tyres used are not factory approved, the tyres must not have a rim protection ridge.

Wheel covers must not impair brake cooling.

### ⚠ Warning

Use of unsuitable tyres or wheel covers could lead to sudden pressure loss and thereby accidents.

Vehicles with steel wheels: When using locking wheel nuts, do not attach wheel covers.

## Tyre chains

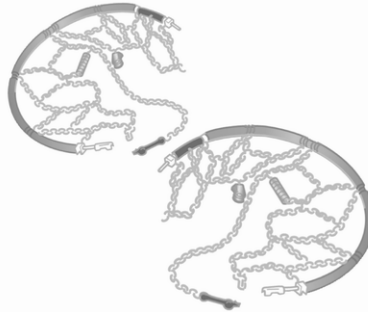

Tyre chains are only permitted on the front wheels.

Always use fine mesh chains that add no more than 9 mm to the tyre tread and the inboard sides (including chain lock).

### ⚠ Warning

Damage may lead to tyre blowout.

Tyre chains are permitted on all tyre sizes allowed for the vehicle.

## Temporary spare wheel

The use of tyre chains is not permitted on the temporary spare wheel.

## Tyre repair kit

Minor damage to the tyre tread can be repaired with the tyre repair kit.

Do not remove foreign bodies from the tyres.

Tyre damage exceeding 4 mm or that is at tyre's sidewall cannot be repaired with the tyre repair kit.

### ⚠ Warning

Do not drive faster than 50 mph.  
Do not use for a lengthy period.  
Steering and handling may be affected.

In the case of a flat tyre:

Apply the parking brake and engage first gear, reverse gear or **P**.

Open the cover of the footwell storage  
⇨ 73.

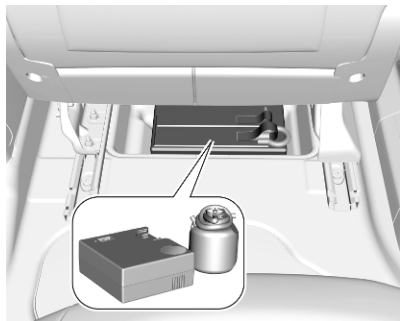

The tyre repair kit is located in the storage compartment underneath the passenger front seat.

1. Remove the sealant bottle and the compressor.
2. Pull speed limit label from sealant bottle and place it in driver's visible area.

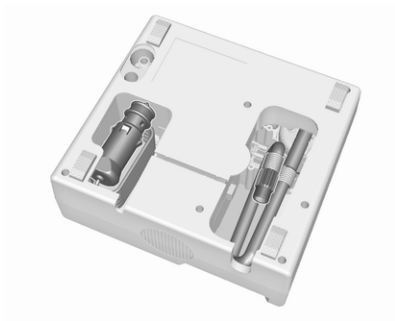

3. Remove the electrical connection cable and air hose from the storage compartments on the underside of the compressor.

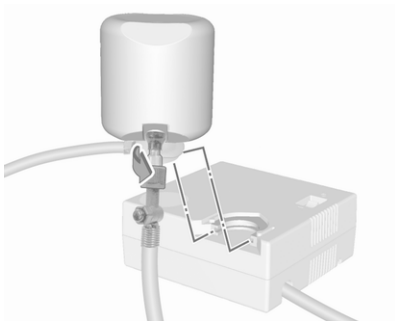

4. Screw the compressor air hose to the connection on the sealant bottle.
5. Fit the sealant bottle into the bracket on the compressor.  
Set the compressor near the tyre in such a way that the sealant bottle is upright.
6. Unscrew valve cap from defective tyre.

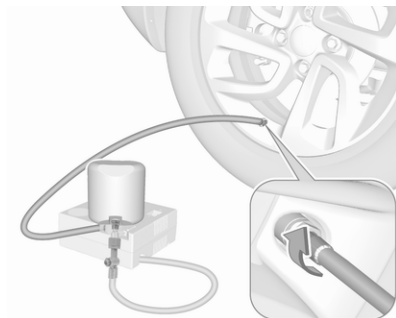

7. Screw the filler hose to the tyre valve.
8. The switch on the compressor must be set to O.

9. Connect the compressor plug to the power outlet or cigarette lighter socket.

The tyre repair kit may only be plugged in to the front 12 V power outlet, in order to work properly.

To avoid discharging the battery, we recommend running the engine.

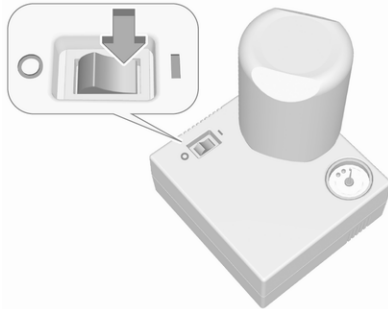

10. Set the rocker switch on the compressor to I. The tyre is filled with sealant.

11. The compressor pressure gauge briefly indicates up to 600 kPa (6 bar) whilst the sealant bottle is emptying (approx. 30 s). Then the pressure starts to drop.
12. All of the sealant is pumped into the tyre. Then the tyre is being inflated.
13. The prescribed tyre pressure should be obtained within ten minutes.

Tyre pressure ⇨ 263.

When the correct pressure is obtained, switch off the compressor.

If the prescribed tyre pressure is not obtained within ten minutes, remove the tyre repair kit. Move the vehicle one tyre rotation. Reattach the tyre repair kit and continue the filling procedure for ten minutes. If the prescribed tyre pressure is still not obtained, the tyre is too badly damaged. Seek the assistance of a workshop.

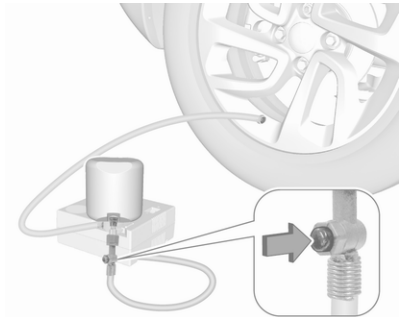

Drain excess tyre pressure with the button on the air hose.

Do not run the compressor longer than ten minutes.

14. Detach the tyre repair kit. Remove sealant bottle from bracket. Screw the filler hose to the free connection of the sealant bottle. This prevents sealant from escaping. Stow tyre repair kit in load compartment.
15. Remove any excess sealant using a cloth.

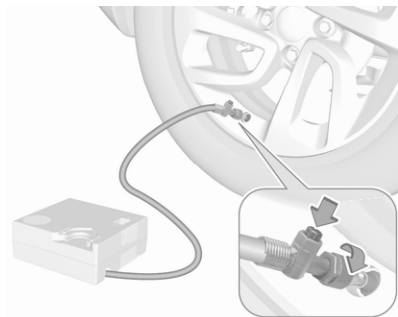

16. Continue driving immediately so that sealant is evenly distributed in the tyre. After driving approx. three miles but no more than ten minutes, stop and check tyre pressure. Screw compressor air hose directly onto tyre valve when doing this. Fill tyre as described before. Drain excess tyre pressure with the button on the air hose.

If tyre pressure hasn't decreased under 150 kPa (1.5 bar), set it to the correct value. Otherwise the vehicle must not be used. Seek assistance of a workshop. ↪ 263

Repeat the checking procedure once more after driving further three miles but no more than ten minutes to check that there is no more loss of pressure.

If the tyre pressure has fallen below 150 kPa (1.5 bar), the vehicle must not be used. Seek the assistance of a workshop.

17. Stow away tyre repair kit in load compartment.

#### Notice

The driving characteristics of the repaired tyre are severely affected, therefore have this tyre replaced.

If unusual noise is heard or the compressor becomes hot, turn compressor off for at least 30 min.

The built-in safety valve opens at a pressure of seven bar (102 psi).

Note the expiry date of the kit. After this date its sealing capability is no longer guaranteed. Pay attention to storage information on sealant bottle.

Replace the used sealant bottle. Dispose of the bottle as prescribed by applicable laws.

The compressor and sealant can be used from approx. -30 °C.

## Wheel changing

Make the following preparations and observe the following information:

- Park the vehicle on a level, firm and non-skid surface. The front wheels must be in the straight-ahead position.
- If necessary, place a chock under the wheel diagonally opposite the wheel to be changed.
- Apply the parking brake and engage first gear, reverse gear or **P**.
- If the ground on which the vehicle is standing is soft, a solid board (max. 1 cm thick) should be placed under the jack.
- Take heavy objects out of the vehicle before jacking up.
- No people or animals may be in the vehicle when it is jacked-up.



- Never crawl under a jacked-up vehicle.
- Do not start the vehicle when it is raised on the jack.
- Before screwing in the wheel bolts, clean them.

### **⚠ Warning**

Do not grease wheel bolts.

### **Tightening torques**

#### **Caution**

If the vehicle is equipped with alloy wheels, tighten the wheel bolts manually at least for the first five turns.

There are two different types of wheels with two different bolts and tightening torques.

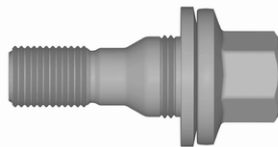

Tightening torque for alloy wheels is 100 Nm.



Tightening torque for steel wheels is 115 Nm.

Use the correct wheel bolts for the respective wheels.

### **Jacking positions**

The jacking positions shown refer to the use of lifting arms and accessory jacks used for changing winter / summer tyres.

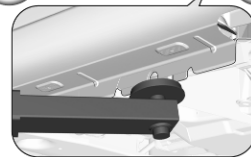

The rear arm position of the lifting platform is centrally under the relevant vehicle jacking point.

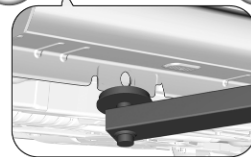

The front arm position of the lifting platform is centrally under the relevant vehicle jacking point.

## Spare wheel

The spare wheel can be classified as a temporary spare wheel depending on the size compared to the other mounted wheels and country regulations. In this case a permissible maximum speed applies, even though no label at the spare wheel indicates this.

Only mount one temporary spare wheel. Do not drive faster than 50 mph. Take curves slowly. Do not use for a long period of time.

### Caution

The use of a spare wheel that is smaller than the other wheels or in combination with winter tyres could affect driveability. Have the defective tyre replaced as soon as possible.

The spare wheel is located in a holder beneath the vehicle floor.

1. Depending on the version, open the tailgate or the rear doors ⇨ 30, ⇨ 31.

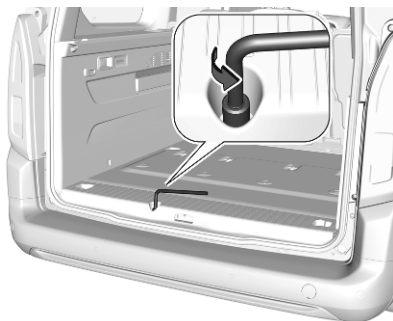

2. Fit the wheel wrench on one hexagon bolt. Turn it anticlockwise until the spare wheel holder is low enough allow the catch to be unhooked.

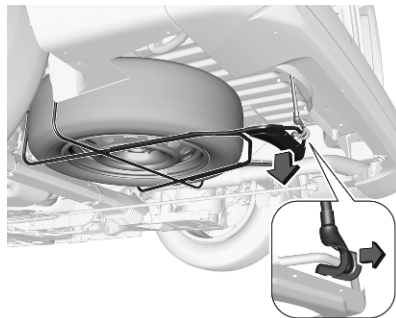

3. Lift the spare wheel holder and unhook the catch. Lower the spare wheel holder.

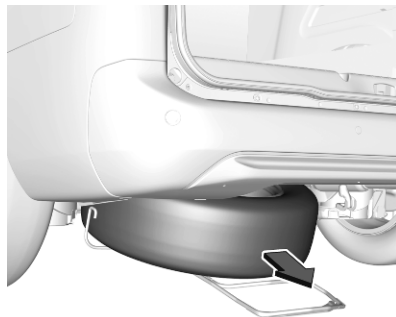

4. Remove the spare wheel.

5. Change the wheel.
6. Position the damaged wheel with the outside down in the spare wheel holder.
7. Lift the spare wheel holder and engage in the catch. The open side of the catch must point in the direction of travel.
8. Close the spare wheel holder by turning the hexagon bolt clockwise using the wheel wrench.
9. Stow wheel wrench in the storage.
10. Close the tailgate or the rear doors.

Only mount one temporary spare wheel. The permissible maximum speed on the label on the temporary spare wheel is only valid for the factory-fitted tyre size.

### Fitting the spare wheel

Make the following preparations and observe the following information:

- Park the vehicle on a level, firm and non-skid surface. The front wheels must be in the straight-ahead position.

- If necessary, place a chock under the wheel diagonally opposite the wheel to be changed.
- Apply the parking brake and engage first gear, reverse gear or **P**.
- Remove the spare wheel ⇨ 240.
- Never change more than one wheel at once.
- Use the jack only to change wheels in case of puncture, not for seasonal winter or summer tyre change.
- The jack is maintenance-free.
- If the ground on which the vehicle is standing is soft, a solid board (max. 1 cm thick) should be placed under the jack.
- Take heavy objects out of the vehicle before jacking up.
- No people or animals may be in the vehicle when it is jacked-up.
- Never crawl under a jacked-up vehicle.
- Do not start the vehicle when it is raised on the jack.

- Before screwing in the wheel bolts, clean them.

#### ⚠ Warning

Do not grease wheel bolts.

#### ⚠ Warning

Ensure to use always the correct wheel bolts if changing the wheels. When installing the spare wheel, the bolts for alloy wheels can also be used.

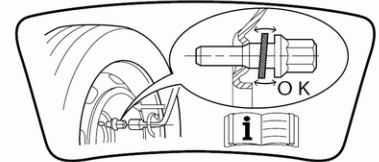

- Note that the spare wheel is secured by the conical contact of each bolt if the wheel bolts for the alloy wheels are used. In this case, the washers do not come into contact with the spare wheel.

1. Disengage wheel bolt caps with the wheel bolt cover remover.  
↪ 230

Steel wheels with cover: Pull off the wheel cover.

Alloy wheels: Disengage wheel bolt caps with the wheel bolt cover remover.



2. Attach the wheel wrench and loosen each wheel bolt by half a turn.

The wheels might be protected by locking wheel nuts. To loosen these specific nuts first attach the adapter onto the head of the nut before installing the wheel wrench. The adapter is located in the tool box. ↪ 230

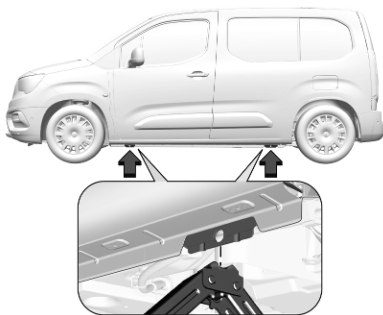

3. Ensure the jack is correctly positioned under the relevant vehicle jacking point.

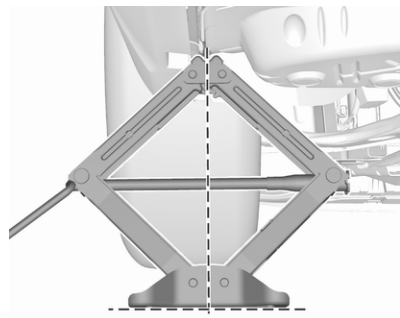

4. Set the jack to the necessary height. Position it directly below the jacking point in a manner that prevents it from slipping.

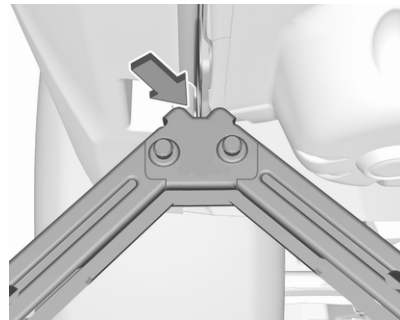

Ensure that the edge of the body fits into the notch of the jack.



With the jack correctly aligned rotate wheel wrench until wheel is clear of the ground.

5. Unscrew the wheel nuts.
6. Change the wheel.  
Spare wheel ⇨ 240.
7. Screw on the wheel nuts.
8. Lower the vehicle and remove jack.
9. Install the wheel wrench ensuring that it is located securely and tighten each bolt in a crosswise sequence. Tightening torque is 115 Nm.

If the vehicle is equipped with alloy wheels, note that the wheel bolts can also be used for the steel spare wheel. In this case, the spare wheel is secured by the conical contact of each bolt.

10. Align the valve hole in the wheel cover with the tyre valve before installing.

Install wheel nut caps.

11. Stow the replaced wheel ⇨ 240, the vehicle tools ⇨ 230 and the adapter for the locking wheel nuts.
12. Check the tyre pressure of the installed tyre and the wheel nut torque as soon as possible.

## Jump starting

Do not start with quick charger.

A vehicle with a discharged vehicle battery can be started using jump leads and the vehicle battery of another vehicle.

### ⚠ Warning

Be extremely careful when starting with jump leads. Any deviation from the following instructions can lead to injuries or damage caused by battery explosion or damage to the electrical systems of both vehicles.

### ⚠ Warning

Avoid contact of the battery with eyes, skin, fabrics and painted surfaces. The fluid contains sulphuric acid which can cause injuries and damage in the event of direct contact.

- Never expose the vehicle battery to naked flames or sparks.

- A discharged vehicle battery can already freeze at a temperature of 0 °C. Defrost the frozen battery before connecting jump leads.
- Wear eye protection and protective clothing when handling a battery.
- Use a booster battery with the same voltage (12 V). Its capacity (Ah) must not be much less than that of the discharged vehicle battery.
- Use jump leads with insulated terminals and a cross section of at least 16 mm<sup>2</sup> (25 mm<sup>2</sup> for diesel engines).
- Do not disconnect the discharged vehicle battery from the vehicle.
- Switch off all unnecessary electrical consumers.
- Do not lean over the vehicle battery during jump starting.
- Do not allow the terminals of one lead to touch those of the other lead.

- The vehicles must not come into contact with each other during the jump starting process.
- Apply the parking brake, transmission in neutral, automatic transmission in **P**.

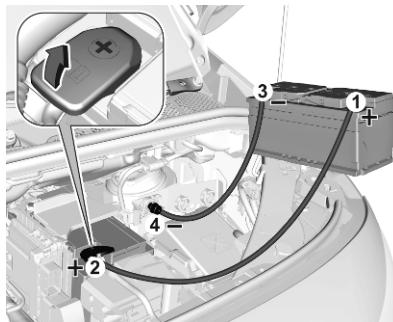

Open the positive terminal protection caps of both vehicle batteries.

Lead connection order:

1. Connect the red lead to the positive terminal of the booster battery.
2. Connect the other end of the red lead to the positive terminal of the discharged battery.

3. Connect the black lead to the negative terminal of the booster battery.
4. Connect the other end of the black lead to a vehicle grounding point of your vehicle in the engine compartment.

Route the leads so that they cannot catch on rotating parts in the engine compartment.

To start the engine:

1. Start the engine of the vehicle providing the jump.
2. After five minutes, start the other engine. Start attempts should be made for no longer than 15 s at an interval of 1 min.
3. Allow both engines to idle for approx. three minutes with the leads connected.
4. Switch on electrical consumers e.g. headlights, heated rear window of the vehicle receiving the jump start.
5. Reverse above sequence exactly when removing leads.

## Towing

### Towing the vehicle

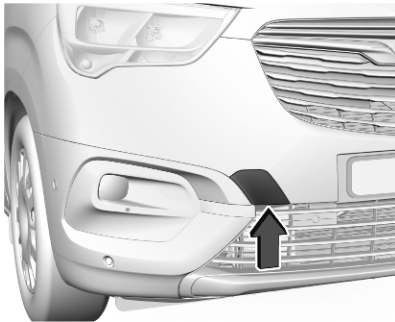

Wrap a cloth around the tip of a flat screwdriver to prevent paint damage. Insert the screwdriver in the slot at the lower part of the cap. Release the cap carefully.

The towing eye is stowed with the vehicle tools ⇨ 230.



Screw in the towing eye as far as it will go until it stops in a horizontal position.

Attach a tow rope – or better still a tow rod – to the towing eye.

The towing eye must only be used for towing and not for recovering the vehicle.

Switch on ignition to release steering wheel lock and to permit operation of brake lights, horn and windscreen wiper.

#### Caution

Deactivate the driver assistance systems like active emergency braking ⇨ 179, otherwise the vehicle may automatically brake during towing.

Switch the selector lever to neutral.  
Release the parking brake.

#### Caution

Never tow a vehicle equipped with All Wheel Drive (AWD) with the front or rear tyres on the road. If you tow a vehicle equipped with AWD while the front or rear tyres are rolling on the road, the drive system in the vehicle could be severely damaged. When towing vehicles equipped with AWD, all four tyres must not be in contact with the road.

**Caution**

Drive slowly. Do not drive jerkily. Excessive tractive force can damage the vehicle.

When the engine is not running, considerably more force is needed to brake and steer.

To prevent the entry of exhaust gases from the towing vehicle, switch on the air recirculation and close the windows.

Vehicles with automatic transmission: The vehicle must be towed facing forwards, not faster than 50 mph nor further than 60 miles. In all other cases and when the transmission is defective, the front axle must be raised off the ground.

Seek the assistance of a workshop.

After towing, unscrew the towing eye.

Insert cap with the flange into the recess and fix cap by pushing.

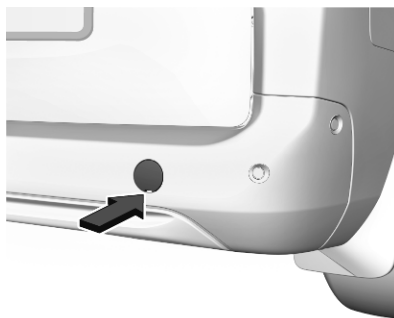
**Towing another vehicle**

Wrap a cloth around the tip of a flat screwdriver to prevent paint damage. Insert the screwdriver in the slot at the lower part of the cap. Release the cap carefully.

The towing eye is stowed with the vehicle tools ↗ 230.



Screw in the towing eye as far as it will go until it stops in a horizontal position.

The lashing eye at the rear underneath the vehicle must never be used as a towing eye.

Attach a tow rope – or better still a tow rod – to the towing eye.

The towing eye must only be used for towing and not for recovering a vehicle.



**Caution**

Drive slowly. Do not drive jerkily. Excessive tractive force can damage the vehicle.

After towing, unscrew the towing eye. Insert cap with the upper flange into the recess and fix cap by pushing.

**Appearance care****Exterior care****Locks**

The locks are lubricated at the factory using a high quality lock cylinder grease. Use a de-icing agent only when absolutely necessary, as this has a degreasing effect and impairs lock function. After using a de-icing agent, have the locks regreased by a workshop.

**Washing**

The paintwork of your vehicle is exposed to environmental influences.

Bird droppings, dead insects, resin, pollen and the like should be cleaned off immediately, as they contain aggressive constituents which can cause paint damage.

If using a vehicle wash, comply with the vehicle wash manufacturer's instructions. The windscreen wiper and rear window wiper must be

switched off. Remove antenna and external accessories such as roof racks etc.

If you wash your vehicle by hand, make sure that the insides of the wheel housings are also thoroughly rinsed out.

Wax painted parts of the vehicle regularly.

Clean edges and folds on opened doors and the bonnet as well as the areas they cover.

Clean bright metal mouldings with a cleaning solution approved for aluminium to avoid damages.

**Caution**

Always use a cleaning agent with a pH value of 4 to 9.

Do not use cleaning agents on hot surfaces.

Do not clean the engine compartment with a steam-jet or high-pressure jet cleaner.

Thoroughly rinse and leather-off the vehicle. Rinse leather frequently. Use separate leathers for painted and glass surfaces: remnants of wax on the windows will impair vision.

Have the door hinges of all doors greased by a workshop.

### **Exterior lights**

Headlight and other light covers are made of plastic. Do not use any abrasive or caustic agents, do not use an ice scraper, and do not clean them dry.

### **Polishing and waxing**

Polishing is necessary only if the paint has become dull or if solid deposits have become attached to it.

Plastic body parts must not be treated with wax or polishing agents.

### **Windows and wiper blades**

Switch off wipers before handling in their areas.

Use a soft lint-free cloth or chamois leather together with window cleaner and insect remover.

When cleaning the rear window from inside, always wipe in parallel to the heating element to prevent damage.

For mechanical removal of ice, use a sharp-edged ice scraper. Press the scraper firmly against the glass so that no dirt can get under it and scratch the glass.

Clean smearing wiper blades with a soft cloth and window cleaner. Also make sure to remove any residues such as wax, insect residues and similar from the window.

Ice residues, pollution and continuous wiping on dry windows will damage or even destroy the wiper blades.

### **Glass panel**

Use a soft lint-free cloth or chamois leather together with window cleaner to clean the glass panel.

### **Wheels and tyres**

Do not use high-pressure jet cleaners.

Clean rims with a pH-neutral wheel cleaner.

Rims are painted and can be treated with the same agents as the body.

### **Paintwork damage**

Rectify minor paintwork damage with a touch-up pen before rust forms. Have more extensive damage or rust areas repaired by a workshop.

### **Underbody**

Some areas of the vehicle underbody have a PVC undercoating while other critical areas have a durable protective wax coating.

After the underbody is washed, check the underbody and have it waxed if necessary.

Bitumen / rubber materials could damage the PVC coating. Have underbody work carried out by a workshop.

Before and after winter, wash the underbody and have the protective wax coating checked.

## Liquid gas system

### Danger

Liquid gas is heavier than air and can collect in sink points.

Take care when performing work at the underbody in a pit.

For painting work and when using a drying booth at a temperature above 60 °C, the liquid gas tank must be removed.

Do not make any modifications to the liquid gas system.

## Towing equipment

Do not clean the coupling ball bar with a steam-jet or high-pressure jet cleaner.

## Interior care

### Interior and upholstery

Only clean the vehicle interior, including the instrument panel fascia and panelling, with a dry cloth or interior cleaner.

Clean the leather upholstery with clear water and a soft cloth. In case of heavy soiling, use leather care.

The instrument cluster and the displays should only be cleaned using a soft damp cloth. If necessary use a weak soap solution.

Clean fabric upholstery with a vacuum cleaner and brush. Remove stains with an upholstery cleaner.

Clothing fabrics may not be colourfast. This could cause visible discolourations, especially on light-coloured upholstery. Removable stains and discolourations should be cleaned as soon as possible.

Clean seat belts with lukewarm water or interior cleaner.

### Caution

Close Velcro fasteners as open Velcro fasteners on clothing could damage seat upholstery.

The same applies to clothing with sharp-edged objects, like zips or belts or studded jeans.

## Plastic and rubber parts

Plastic and rubber parts can be cleaned with the same cleaner as used to clean the body. Use interior cleaner if necessary. Do not use any other agent. Avoid solvents and petrol in particular. Do not use high-pressure jet cleaners.

## Floor mats

### Warning

If a floor mat has the wrong size or is not properly installed, it can interfere with the accelerator pedal and/or brake pedal, what can cause unintended acceleration and/or increased stopping distance which can cause a crash and injury.

Use the following guidelines for proper floor mat usage.

- The original equipped floor mats were designed for your vehicle. Have damaged floor mats only

replaced by certified floor mats. Always check that the floor mats do not interfere with the pedals.

- Use the floor mat with the correct side up. Do not turn it over.
- Do not place anything on top of the driver's side floor mat.
- Use only a single floor mat on the driver's side.

### Installing and removing the floor mats

The driver's side floor mat and the passenger's side floor mat are each held in place by two retainers.

To install the floor mat:

1. Move the seat backwards as far as possible.

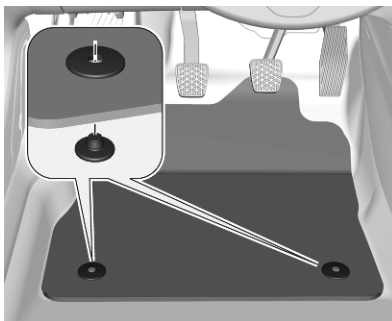

2. Align slots in the mat with the retainers, as shown.
3. Push the mat to the floor.

To remove the floor mat:

1. Move the seat backwards as far as possible.
2. Pull the floor mat upwards to remove.

## Service and maintenance

<b>General information</b> .....	<b>251</b>
Service information .....	251
<b>Recommended fluids, lubricants and parts</b> .....	<b>254</b>
Recommended fluids and lubricants .....	254

## General information

### Service information

In order to ensure economical and safe vehicle operation and to maintain the value of your vehicle, it is of vital importance that all maintenance work is carried out at the proper intervals as specified.

The detailed, up-to-date service schedule for your vehicle is available at the workshop.

Severe operating conditions exist if one or more of the following circumstances occur frequently: Cold starting, stop and go operation, e.g. for taxis and police vehicles, trailer operation, mountain driving, driving on poor and sandy road surfaces, increased air pollution, presence of airborne sand and high dust content, driving at high altitude and large variations of temperature.

Under these severe operating conditions, certain service work may be required more frequently than the regular service interval indicated in

the service display. Contact a workshop for customised service schedules.

Service display ⇨ 99.

## 252 Service and maintenance

---

### Service intervals – Combo Life

Engine code	EB2ADT	DV5RC DV5RCf DV5RD DV5RE	DV6D
Country group 1	12,000 miles / 1 year	19,000 miles / 1 year <sup>1)</sup>	
Country group 2	9,000 miles / 1 year	19,000 miles / 1 year	
Country group 3	9,000 miles / 1 year	9,000 miles / 1 year	9,000 miles / 1 year
Country group 4	9,000 miles / 1 year	9,000 miles / 1 year	9,000 miles / 1 year
Country group 5	6,000 miles / 1 year	6,000 miles / 1 year	6,000 miles / 1 year

1) Unless otherwise indicated in the service display.

### Service intervals – Combo

Engine code	EB2ADT EB2ADTS	DV5RC DV5RD DV5RE	DV6FE DV6FD	DV6D
Country group 1	12,000 miles / 1 year	25,000 miles / 2 year	16,000 miles / 1 year	
Country group 2	9,000 miles / 1 year	25,000 miles / 2 year	16,000 miles / 1 year	
Country group 3	9,000 miles / 1 year	9,000 miles / 1 year	9,000 miles / 1 year	9,000 miles / 1 year

Engine code	EB2ADT	DV5RC	DV6FE	DV6D
	EB2ADTS	DV5RD DV5RE	DV6FD	
Country group 4	9,000 miles / 1 year	9,000 miles / 1 year	9,000 miles / 1 year	9,000 miles / 1 year
Country group 5	6,000 miles / 1 year	6,000 miles / 1 year	6,000 miles / 1 year	6,000 miles / 1 year

**Country Group 1:**

Andorra, Austria, Belgium, Cyprus, Denmark, Finland, France, Germany, Greece, Iceland, Ireland, Italy, Liechtenstein, Luxembourg, Malta, Monaco, Netherlands, Norway, Portugal, San Marino, Spain, Sweden, Switzerland, United Kingdom.

**Country Group 2:**

Bosnia-Herzegovina, Bulgaria, Croatia, Czech Republic, Estonia, Hungary, Latvia, Lithuania, North Macedonia, Poland, Romania, Slovakia, Slovenia.

**Country Group 3:**

Albania, Montenegro, Serbia.

**Country Group 4:**

Israel, South Africa, Turkey.

**Country Group 5:**

All other countries which are not listed in the previous country groups.

**Confirmations**

Confirmation of service is recorded in the Service and warranty booklet. The date and mileage is completed with the stamp and signature of the servicing workshop.

Make sure that the Service and warranty booklet is completed correctly as continuous proof of service is essential if any warranty or goodwill claims are to be met, and is also a benefit when selling the vehicle.

## Recommended fluids, lubricants and parts

### Recommended fluids and lubricants

Only use products that meet the recommended specifications.

#### Warning

Operating materials are hazardous and could be poisonous. Handle with care. Pay attention to information given on the containers.

### Engine oil

Engine oil is identified by its quality and its viscosity. Quality is more important than viscosity when selecting which engine oil to use. The engine oil quality ensures e.g. engine cleanliness, wear protection and engine oil aging control, whereas viscosity grade gives information on the oil's thickness over a temperature range.

Select the appropriate engine oil based on its quality and on the minimum ambient temperature ⇨ 258.

#### Topping up engine oil

##### Caution

In case of any spilled oil, wipe it up and dispose it properly.

Engine oils of different manufacturers and brands can be mixed as long as they comply with the required engine oil quality and viscosity.

Select the appropriate engine oil based on its quality and on the minimum ambient temperature ⇨ 258.

#### Additional engine oil additives

The use of additional engine oil additives could cause damage and invalidate the warranty.

#### Engine oil viscosity grades

The SAE viscosity grade gives information of the thickness of the oil.

Multigrade oil is indicated by two figures, e.g. SAE 5W-30. The first figure, followed by a W, indicates the low temperature viscosity and the second figure the high temperature viscosity.

Select the appropriate viscosity grade depending on the minimum ambient temperature ⇨ 258.

All of the recommended viscosity grades are suitable for high ambient temperatures.

### Coolant and antifreeze

Use only organic acid type-long life coolant (LLC) antifreeze approved for the vehicle. Consult a workshop.

The system is factory filled with coolant designed for excellent corrosion protection and frost protection down to approx. -37 °C. This concentration should be maintained all year round. The use of additional coolant additives that intend to give additional corrosion protection or seal against minor leaks can cause function problems. Liability



for consequences resulting from the use of additional coolant additives will be rejected.

### **Washer fluid**

Use only washer fluid approved for the vehicle to prevent damage of wiper blades, paintwork, plastic and rubber parts. Consult a workshop.

### **Brake fluid**

Over time, brake fluid absorbs moisture which will reduce braking effectiveness. The brake fluid should therefore be replaced at the specified interval.

### **AdBlue**

Only use AdBlue to reduce the nitrogen oxides in the exhaust emission ↪ 152.

## Technical data

<b>Vehicle identification</b> .....	<b>256</b>
Vehicle identification number ..	256
Identification plate .....	256
Engine identification .....	257
<b>Vehicle data</b> .....	<b>258</b>
Recommended fluids and lubricants .....	258
Engine data .....	260
Vehicle dimensions .....	262
Capacities .....	263
Tyre pressures .....	264

## Vehicle identification

### Vehicle identification number



The Vehicle Identification Number may be embossed on the instrument panel, visible through the windscreen.

## Identification plate



The identification plate is located on the front left or right door frame.

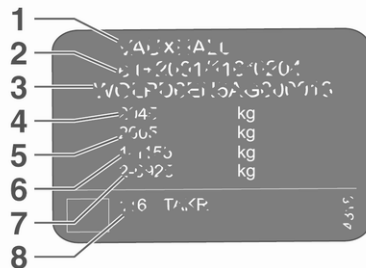

Information on identification label:

- 1 : manufacturer
- 2 : type approval number
- 3 : vehicle identification number
- 4 : permissible gross vehicle weight rating in kg
- 5 : permissible gross train weight in kg
- 6 : maximum permissible front axle load in kg
- 7 : maximum permissible rear axle load in kg
- 8 : vehicle-specific or country-specific data

The combined total of front and rear axle loads must not exceed the permissible gross vehicle weight.

Vehicle's kerb weight depends on the specification of the vehicle, e.g. optional equipment and accessories. Refer to the EEC Certificate of Conformity provided with your vehicle or other national registration documents.

The technical data is determined in accordance with European Community standards. We reserve the right to make modifications.

Specifications in the vehicle documents always have priority over those given in this manual.

## Engine identification

The technical data tables show the engine identifier code.

Engine data ⇨ 260.

To identify the respective engine, refer to the engine power in the EEC Certificate of Conformity provided with your vehicle or other national registration documents.

## Vehicle data

### Recommended fluids and lubricants

#### Required engine oil quality

Country groups ⇨ 251

#### Countries included in country groups 1 to 3

EB2FA	EP6FDTM
EB2ADT	EB2DT
EB2ADTS	EC5F
EP6FADTXD	DW10FC
DV5RC	DV6D
DV5RD	DV6FD
DV5RE	DV6FE

---

#### Vauxhall Original engine oil

B71 2010 / B71 2312

B71 2312

---

Engine EC5F: B71 2290, B71 2296 or B71 300 may also be used.

#### Countries included in country group 4

all engines

---

#### Vauxhall Original engine oil

B71 2302 / B71 2297

---

Engine EC5F: B71 2296 or B71 300 may also be used.

Countries included in country group 5

all engines

Vauxhall Original engine oil

B71 2297

Engine oil viscosity grades

Country groups ↗ 251

	<b>B71 2010</b>	<b>B71 2312</b>	<b>B71 2302</b>	<b>B71 2297</b>
Engine oil viscosity grade	SAE 0W-20	SAE 0W-30	SAE 0W-30	SAE 5W-30

## Engine data

	D12XHL F12XHL	F12XHT	Z16XU	D15DTL	D15DT
<b>Engine identifier code</b>					
<b>Sales designation</b>	1.2 Turbo	1.2	1.6	1.5 Turbo	1.5 Turbo
<b>Engineering code</b>	EB2ADT	EB2ADTS	EC5F	DV5RE	DV5RD
Piston displacement [cm <sup>3</sup> ]	1199	1199	1587	1499	1499
Engine power [kW]	81	96	85	56	75
at rpm	5500	5500	5750	3500	3500
Torque [Nm]	205	230	150	230	250
at rpm	1750	1750	4000	1750	1750
Fuel type	Petrol	Petrol	Petrol	Diesel	Diesel
Octane rating RON <sup>1)2)</sup>					
recommended	95	95	95	-	-
possible	98	-	-	-	-

1) A country specific label at the fuel filler flap can supersede the engine specific requirement.

2) In certain countries, the use of a particular fuel, e.g. a specific octane rating, may be required to ensure proper engine operation.

	D15DTH	F15DT	A16DT	B16DTL	B16DT
<b>Engine identifier code</b>	D15DTH	F15DT	A16DT	B16DTL	B16DT
<b>Sales designation</b>	1.5 Turbo	1.5 Turbo	1.6 Turbo	1.6 Turbo	1.6 Turbo
<b>Engineering code</b>	DV5RC	DV5RCf	DV6D	DV6FE	DV6FD
Piston displacement [cm <sup>3</sup> ]	1499	1499	1560	1560	1560
Engine power [kW]	96	75	68	55	74
at rpm	3750	3750	4000	3500	3750
Torque [Nm]	300	240	230	210	255
at rpm	1750	1750	1750	1750	1750
Fuel type	Diesel	Diesel	Diesel	Diesel	Diesel

**Vehicle dimensions**

<b>Size</b>	<b>L1</b>	<b>L2</b>
Length [mm]	4403	4753
Width without exterior mirrors [mm]	1848	1848
Width with exterior mirrors [mm]	2107	2107
Combo LIFE Height without roof railing [mm]	1800 - 1807	1812 - 1818
Combo LIFE Height with roof railing [mm]	1837 - 1844	1843 - 1849
Combo Height without roof railing [mm]	1796 - 1851	1815 - 1821
Combo Height with roof railing [mm]	1797 - 1998	1845 - 1857
Wheelbase [mm]	2785	2975 / 2977
Turning circle diameter [m]	10.8 / 11	11.5 / 11.8

---



## Capacities

### Engine oil

Engine	DV5RC DV5RCf DV5RD DV5RE	EB2ADT EB2ADTS	DV6D DV6FE DV6FD	EC5F
including filter [l]	3.95 <sup>3)</sup> 5.3 <sup>4)</sup>	3.5	3.75	3.25
between MIN and MAX [l]	1	1		1.5

3) Combo LIFE

4) Combo

### Fuel tank

Petrol / diesel, refilling quantity [l] 60 / 50

### AdBlue tank

AdBlue, refilling quantity [l] 17

## Tyre pressures

Combo

Payload 650 kg

Tyres	Vehicle with up to 3 people		With full load	
	front	rear	front	rear
	[kPa/bar] ([psi])	[kPa/bar] ([psi])	[kPa/bar] ([psi])	[kPa/bar] ([psi])
195/65 R16	260/2,6 (38)	290/2,9 (42)	260/2,6 (38)	320/3,2 (46)
205/60 R16	250/2,5 (36)	250/2,5 (36)	250/2,5 (36)	320/3,2 (46)
215/65 R16	260/2,6 (38)	280/2,8 (41)	260/2,6 (38)	300/3,0 (44)

**Payload 1000 kg**

Tyres	Vehicle with up to 3 people		With full load	
	front	rear	front	rear
	[kPa/bar] ([psi])	[kPa/bar] ([psi])	[kPa/bar] ([psi])	[kPa/bar] ([psi])
205/60 R16	250/2,5 (36)	290/2,9 (42)	250/2,5 (36)	290/2,9 (42)
215/65 R16	260/2,6 (38)	280/2,8 (41)	260/2,6 (38)	300/3,0 (44)

**Combo LIFE**

Tyres	Vehicle with up to 3 people		With full load	
	front	rear	front	rear
	[kPa/bar] ([psi])	[kPa/bar] ([psi])	[kPa/bar] ([psi])	[kPa/bar] ([psi])
195/65 R16	260/2,6 (38)	290/2,9 (42)	260/2,6 (38)	320/3,2 (46)
205/60 R16	240/2,4 (35)	240/2,4 (35)	260/2,6 (38)	320/3,2 (46)
205/60 R17	250/2,5 (36)	250/2,5 (36)	260/2,6 (38)	320/3,2 (46)

## Customer information

<b>Customer information</b> .....	<b>266</b>
Declaration of conformity .....	266
REACH .....	267
Registered trademarks .....	267
<b>Vehicle data recording and privacy</b> .....	<b>268</b>
Event data recorders .....	268
Radio Frequency Identification (RFID) .....	271

## Customer information

### Declaration of conformity

#### Radio transmission systems

This vehicle has systems that transmit and / or receive radio waves subject to Directive 2014/53/EU. The manufacturers of the systems listed below declare conformity with Directive 2014/53/EU. The full text of the EU declaration of conformity for each system is available at the following internet address: [www.opel.com/conformity](http://www.opel.com/conformity).

Importer is  
Opel / Vauxhall, Bahnhofspatz,  
65423 Ruesselsheim am Main,  
Germany.

#### Infotainment system Multimedia Navi Pro

Continental

LCIE Bureau Veritas-Site de  
Fontenay aux Roses, 33 avenue du  
général Leclerc, 92260 Fontenay aux  
Roses, France

Operation frequency (MHz)	Maximum output (dBm)
---------------------------	----------------------

2400.0 - 2483.5	2.2
-----------------	-----

2400.0 - 2483.5	15
-----------------	----

#### Infotainment system Radio

Clarion

244 rue du Pré à Varois, 54670  
Custines, France

Operation frequency:  
2400 - 2480 MHz

Maximum output: 4 dBm

#### Infotainment system Multimedia

Robert Bosch Car Multimedia GmbH

Robert-Bosch-Straße 200, 31139  
Hildesheim, Germany

Operation frequency (MHz)	Maximum output (dBm)
---------------------------	----------------------

2402.0 - 2480.0	17
-----------------	----

2412.0 - 2472.0	4.15
-----------------	------

#### Antenna module

Yokowo Manufacturing of America,  
LLC

28221 Beck Road, Unit A-21  
Wixom, MI 48394, USA  
Operation frequency: N/A  
Maximum output: N/A  
ASK Automotive Pvt. Ltd.  
Unit 2 Plot No. 30-31, Fathepur-  
Nawada, Manesar, Gurugram,  
Haryana 122050, India  
Operation frequency: N/A  
Maximum output: N/A

**Radio remote control transmitter**  
Hülsbeck & Fürst GmbH & Co. KG  
Steeger Straße 17  
42551 Velbert, Germany  
Operation frequency: 433.92 MHz  
Maximum output: 10 dBm

**Radio remote control receiver**  
Delphi European, Middle Eastern &  
African Regional Offices Customer  
Technology  
Center Avenue de Luxembourg,  
L-4940 Bascharage, G.D. of  
Luxembourg  
Operation frequency: 119 - 128.6

Maximum output:  
16 dB $\mu$ A/m @ 10 m

**Electronic key transmitter**  
Valeo

43 Rue Bayen, 75017 Paris, France  
Operation frequency: 433.92 MHz  
Maximum output: 10 dBm

**Immobiliser**  
KOSTAL of America, Inc.  
350 Stephenson Hwy, Troy MI 48083,  
USA

Operation frequency: 125 kHz  
Maximum output: 5 dB $\mu$ A/m at 10 m

### **ICASA type approval numbers**

List of all Independent  
Communications Authority of South  
Africa (ICASA) type approval  
numbers:

TA-2016/121, TA-2016/3261,  
TA-2017/2387, TA-2017/2745,  
TA-2013/430, TA-2017/1106,  
TA-2016/929, TA-2017/3180

## **REACH**

Registration, Evaluation,  
Authorisation and Restriction of  
Chemicals (REACH) is a European  
Union regulation adopted to improve  
the protection of human health and  
the environment from the risks that  
can be posed by chemicals. Visit  
[www.opel.com](http://www.opel.com) for further information  
and for access to the Article 33  
communication.

## **Registered trademarks**

### **Apple Inc.**

Apple CarPlay™ is a trademark of  
Apple Inc.

App Store® and iTunes Store® are  
registered trademarks of Apple Inc.

iPhone®, iPod®, iPod touch®, iPod  
nano®, iPad® and Siri® are registered  
trademarks of Apple Inc.

### **Bluetooth SIG, Inc.**

Bluetooth® is a registered trademark  
of Bluetooth SIG, Inc.

### **DivX, LLC**

DivX® and DivX Certified® are  
registered trademarks of DivX, LLC.

**Google Inc.**

Android™ and Google Play™ Store are trademarks of Google Inc.

**Verband der Automobilindustrie e.V.**

AdBlue® is a registered trademark of the VDA.

## Vehicle data recording and privacy

### Event data recorders

Electronic control units are installed in your vehicle. Control units process data which is received by vehicle sensors and other components, or which they generate themselves or exchange amongst themselves. Some control units are necessary for the safe functioning of your vehicle, others assist you while you drive (driver assistance systems), while others provide comfort or infotainment functions.

The following contains general information about data processing in the vehicle. You will find additional information as to which specific data is uploaded, stored and passed on to third parties and for what purpose in your vehicle under the key word Data Protection closely linked to the references for the affected functional characteristics in the relevant Owner's Manual or in the general terms of sale. These are also available online.

### Operating data in the vehicle

Control units process data for operation of the vehicle.

This data includes, e.g.:

- vehicle status information (e.g. speed, movement delay, lateral acceleration, wheel rotation rate, "seat belts fastened" display)
- ambient conditions (e.g. temperature, rain sensor, distance sensor)

As a rule such data is transient, not stored for longer than an operational cycle, and only processed on board the vehicle itself. Control units often include data storage (including the vehicle key). This is used to allow information to be documented temporarily or permanently on vehicle condition, component stress, maintenance requirements and technical events and errors.

Depending on technical equipment level, the data stored is as follows:

- system component operating states (e.g. fill level, tyre pressure, battery status)
- faults and defects in important system components (e.g. lights, brakes)
- system reactions in special driving situations (e.g. triggering of an airbag, actuation of the stability control systems)
- information on events damaging the vehicle
- for electric vehicles the amount of charge in the high-voltage battery, estimated range

In special cases (e.g. if the vehicle has detected a malfunction), it may be necessary to save data that would otherwise just be volatile.

When you use services (e.g. repairs, maintenance), the operating data saved can be read together with the vehicle identification number and used when necessary. Staff working for the service network (e.g. garages, manufacturers) or third parties (e.g.

breakdown services) can read the data from the vehicle. The same applies to warranty work and quality assurance measures.

Data is generally read via the OBD (On-Board Diagnostics) port prescribed by law in the vehicle. The operating data which is read out, documents the technical condition of the vehicle or individual components and assists with fault diagnosis, compliance with warranty obligations and quality improvement. This data, in particular information on component stress, technical events, operator errors and other faults, is transmitted to the manufacturer where appropriate, together with the vehicle identification number. The manufacturer is also subject to product liability. The manufacturer potentially also uses operating data from vehicles for product recalls. This data can also be used to check customer warranty and guarantee claims.

Fault memories in the vehicle can be reset by a service company when carrying out servicing or repairs or at your request.

## Comfort and infotainment functions

Comfort settings and custom settings can be stored in the vehicle and changed or reset at any time.

Depending on the equipment level in question, these include

- seat and steering wheel position settings
- chassis and air conditioning settings
- custom settings such as interior lighting

You can input your own data in the infotainment functions for your vehicle as part of the selected features.

Depending on the equipment level in question, these include

- multimedia data such as music, videos or photos for playback in an integrated multimedia system
- address book data for use with an integrated hands-free system or an integrated navigation system

- input destinations
- data on the use of online services

This data for comfort and infotainment functions can be stored locally in the vehicle or be kept on a device that you have connected to the vehicle (e.g. a smartphone, USB stick or MP3 player). Data that you have input yourself can be deleted at any time.

This data can only be transmitted out of the vehicle at your request, particularly when using online services in accordance with the settings selected by you.

### **Smartphone integration, e.g. Android Auto or Apple CarPlay**

If your vehicle is equipped accordingly, you can connect your smartphone or another mobile device to the vehicle so that you can control it via the controls integrated in the vehicle. The smartphone image and sound can be output via the multimedia system in this case. At the same time, specific information is transmitted to your smartphone. Depending on the type of integration,

this includes data such as position data, day / night mode and other general vehicle information. For more information, please see the operating instructions for the vehicle / infotainment system.

Integration allows selected smartphone apps to be used, such as navigation or music playback. No further integration is possible between smartphone and vehicle, in particular active access to vehicle data. The nature of further data processing is determined by the provider of the app used. Whether you can define settings, and if so which ones, is dependent on the app in question and your smartphone's operating system.

### **Online services**

If your vehicle has a radio network connection, this allows data to be exchanged between your vehicle and other systems. The radio network connection is made possible by means of a transmitter device in your vehicle or a mobile device provided by you (e.g. a smartphone). Online functions can be used via this radio network connection. These include online services and applications / apps provided to you by the manufacturer or other providers.

### **Proprietary services**

In the case of the manufacturer's online services, the relevant functions are described by the manufacturer in an appropriate location (e.g. Owner's Manual, the manufacturer's website) and the associated data protection information is provided. Personal data may be used to provide online services. Data exchange for this purpose takes place via a protected connection, e.g. using the manufacturer's IT systems provided for the purpose. Collection,



processing and use of personal data for the purposes of preparation of services take place solely on the basis of legal permission, e.g. in the case of a legally prescribed emergency communication system or a contractual agreement, or by virtue of consent.

You can activate or deactivate the services and functions (which are subject to charges to some extent) and, in some cases, the vehicle's entire radio network connection. This does not include statutory functions and services such as an emergency communication system.

### **Third party services**

If you make use of online services from other providers (third parties), these services are subject to the liability and data protection and usage conditions of the provider in question. The manufacturer frequently has no influence over the content exchanged in this regard.

Therefore, please note the nature, scope and purpose of the collection and use of personal data within the scope of third party services provided by the service provider in question.

### **Radio Frequency Identification (RFID)**

RFID technology is used in some vehicles for functions such as tyre pressure monitoring and immobiliser. It is also used in connection with conveniences such as radio remote controls for door locking / unlocking and starting. RFID technology in Vauxhall vehicles does not use or record personal information or link with any other Vauxhall system containing personal information.

# Index

## A

Accessories and vehicle modifications .....	211
Active emergency braking ..	107, 179
Adaptive cruise control.....	107, 171
AdBlue.....	105, 152
Adjustable air vents .....	140
Advanced parking assist.....	187
Airbag and belt tensioners .....	101
Airbag deactivation .....	62, 102
Airbag label.....	57
Airbag system .....	57
Air conditioning regular operation .....	141
Air conditioning system .....	131
Air intake .....	141
Air vents.....	140
Antilock brake system .....	159
Antilock brake system (ABS) .....	104
Anti-theft alarm system .....	34
Anti-theft locking system .....	34
Appearance care.....	247
Armrest.....	49
Ashtrays .....	96
Automatic anti-dazzle .....	39
Automatic crash notification (ACN).....	119
Automatic light control .....	122
Automatic locking .....	27

Automatic transmission .....	155
Autostop.....	106, 147

## B

Battery discharge protection .....	129
BlueInjection.....	152
Bonnet .....	213
Brake and clutch system .....	103
Brake assist .....	162
Brake fluid .....	216, 254
Brakes .....	159, 216
Breakdown.....	245
Bulb replacement .....	220

## C

Capacities .....	263
Cargo management system .....	78
Catalytic converter .....	151
Central locking system .....	24
Centre console lighting .....	128
Centre console storage .....	73
Changing tyre and wheel size ..	234
Charging system .....	102
Child locks .....	27
Child restraint installation locations .....	66
Child restraints.....	63
Child restraint systems .....	63
Child surveillance mirror.....	39
Cigarette lighter .....	95
Climate control .....	15

Climate control systems.....	130
Clock.....	93
Colour Info Display.....	115
Control indicators.....	100
Control of the vehicle .....	143
Controls.....	89
Convex shape .....	37
Coolant and antifreeze.....	254
Cruise control .....	107, 167
Cupholders .....	69
Curtain airbag system .....	61

**D**

Danger, Warnings and Cautions ...	4
Daytime running lights .....	124
Declaration of conformity.....	266
DEF.....	152
Deflation detection system.....	105
Descent control system .....	104, 164
Diesel exhaust fluid.....	152
Diesel fuel system bleeding .....	219
Door open .....	107
Doors.....	29, 30, 31
Driver alert.....	201
Driver assistance systems.....	167
Driver Information Centre.....	108
Driving characteristics and towing tips .....	206
Driving hints.....	143

**E**

Eco mode.....	157
Electric adjustment .....	37
Electrical system.....	227
Electric parking brake. 103, 159, 160	
Electric parking brake fault.....	103
Electronic climate control system	134
Electronic driving programmes ..	157
Electronic key system.....	22
Electronic Stability Control and Traction Control system. .	104, 163
Emergency call.....	119
End-of-life vehicle recovery .....	213
Engine compartment fuse box ...	228
Engine coolant .....	215
Engine coolant temperature .....	104
Engine coolant temperature gauge .....	99
Engine data .....	260
Engine exhaust .....	151
Engine identification.....	257
Engine oil .....	214, 254, 258
Engine oil level monitor.....	99
Engine oil pressure .....	105
Entry lighting .....	128
Event data recorders.....	268
Exhaust filter.....	105, 151
Exit lighting .....	128
Exterior care .....	247
Exterior light .....	106

Exterior lighting .....	12, 121
Exterior mirrors.....	37

**F**

Fault .....	157
First aid.....	84
First aid kit .....	84
Fixed air vents .....	141
Floor mats.....	249
Folding front passenger seat.....	47
Folding mirrors .....	37
Folding seats.....	50, 51
Footwell storage.....	73
Forward collision alert.....	178
Front airbag system .....	60
Front fog lights .....	106, 125, 222
Front passenger seat Table position.....	47
Front pedestrian protection.....	182
Front seats.....	45
Front storage.....	70
Front turn lights .....	223
Fuel.....	202
Fuel for diesel engines .....	203
Fuel for petrol engines .....	202
Fuel gauge .....	98
Fuses .....	227

**G**

Gauges.....	97
Gear selection .....	155

Gear shifting.....	104
General information .....	206
Glass panel .....	43
Glovebox .....	69
Graphic Info Display.....	115

## H

Halogen headlights .....	220
Hand brake.....	160
Hazard warning flashers .....	124
Headlight flash .....	123
Headlight range adjustment .....	124
Headlights.....	121
Headlights when driving abroad .....	124
Head restraint adjustment .....	8
Head restraints .....	44
Head-up display.....	112
Heated mirrors .....	38
Heated rear window .....	42
Heated steering wheel .....	89
Heating .....	49
Heating and ventilation system .....	130
High beam .....	106, 122
High beam assist.....	106, 122
Hill start assist .....	162
Horn .....	13, 90

## I

Identification plate .....	256
Ignition switch positions .....	143
Immobiliser .....	36

Indicators.....	97
Inductive charging.....	94
Info Display.....	110
Installing seats.....	51
Instrument cluster .....	96
Instrument panel fuse box .....	229
Instrument panel illumination control .....	126
Instrument panel overview .....	10
Interior care .....	249
Interior lighting.....	126
Interior lights .....	127, 227
Interior mirrors.....	38
Introduction .....	3

## J

Jump starting .....	243
---------------------	-----

## K

Keys .....	20
Keys, locks.....	20

## L

Ladder flap.....	74
Lane keep assist.....	104, 198
Lashing eyes .....	78
LED headlights.....	106, 222
Lighting features.....	128
Light switch .....	121
Load compartment .....	31, 74
Load compartment cover .....	75

Load compartment grille.....	81
Loading.....	47, 50, 51
Loading information .....	85
Low beam.....	106
Low fuel .....	106

## M

Malfunction indicator light .....	102
Manual anti-dazzle .....	38
Manual mode .....	156
Manual transmission .....	158
Mirror adjustment .....	8
Misted light covers .....	126
Multimedia.....	115
Multimedia Navi Pro.....	115

## N

New vehicle running-in .....	143
Number plate light .....	227

## O

Object detection systems.....	183
Odometer .....	97
Oil, engine.....	254, 258
Outside temperature .....	92
Overhead console .....	71
Overload indicator.....	86, 104
Overrun cut-off .....	147

- P**
- Panoramic view system..... 193
  - Parking ..... 19, 150
  - Parking assist ..... 183
  - Parking brake..... 103, 160
  - Parking heater..... 138
  - Parking lights ..... 126
  - Particulate filter..... 151
  - Passenger side camera..... 192
  - Performing work ..... 213
  - Peripheral lighting..... 129
  - Power button..... 144
  - Power outlets ..... 93
  - Power windows ..... 40
  - Preheating ..... 105
  - Puncture..... 240
- R**
- Radio Frequency Identification (RFID)..... 271
  - Radio remote control ..... 21
  - Rain sensor..... 107
  - REACH..... 267
  - Reading lights ..... 127
  - Rear doors ..... 30
  - Rear fog light ..... 107, 125, 224
  - Rear view camera ..... 196
  - Rear view display..... 39, 113
  - Rear windows ..... 42
  - Rear window wiper and washer . . 92
- Recommended fluids and lubricants** ..... 254, 258
- Refuelling** ..... 204
- Registered trademarks**..... 267
- Removing seats**..... 51
- Reversing lights** ..... 126
- Ride control systems**..... 163
- Roadside assistance**..... 119
- Roller blinds** ..... 43
- Roof**..... 43
- Roof load**..... 85
- Roof rack** ..... 84
- S**
- Safety net ..... 79
  - Seat adjustment ..... 7, 46
  - Seat belt ..... 8
  - Seat belt reminder ..... 101
  - Seat belts ..... 54
  - Seat folding ..... 47
  - Seat heating..... 49
  - Seat position ..... 45
  - Second row seats ..... 50
  - Selective catalytic reduction..... 152
  - Selective ride control..... 165
  - Selector lever..... 155
  - Service ..... 141, 251
  - Service display ..... 99
  - Service information ..... 251
  - Service vehicle soon ..... 102
- Side airbag system** ..... 60
- Side blind spot alert**..... 107, 191
- Sidelights**..... 121
- Side turn lights** ..... 226
- Sliding door** ..... 29
- Sliding side door**..... 29
- SOS**..... 119
- Spare wheel** ..... 240
- Speed limiter**..... 107, 169
- Speedometer** ..... 97
- Starting and operating**..... 143
- Starting off** ..... 17
- Starting the engine** ..... 145
- Steering**..... 143
- Steering wheel adjustment** ..... 9, 89
- Steering wheel controls** ..... 89
- Stop engine**..... 102
- Stop-start system**..... 147
- Storage**..... 69
- Storage compartments**..... 69
- Sunvisor lights** ..... 127
- Sun visors** ..... 43
- Symbols** ..... 4
- System check**..... 103
- T**
- Tachometer ..... 98
  - Tailgate..... 31
  - Tail lights ..... 224
  - Third row seats ..... 51

Three-point seat belt .....	55
Tools .....	230
Tow bar.....	206
Towing.....	206, 245
Towing another vehicle .....	246
Towing equipment .....	207
Towing the vehicle .....	245
Trailer coupling.....	206
Trailer stability assist .....	210
Trailer towing .....	206
Transmission .....	17
Transmission display .....	155
Tread depth .....	234
Trip odometer .....	97
Turn lights .....	100, 125
Tyre chains .....	235
Tyre deflation detection system .	233
Tyre designations .....	231
Tyre pressure .....	232
Tyre pressures .....	264
Tyre repair kit .....	235

## U

Ultrasonic parking assist.....	183
Underseat storage .....	72
Upholstery.....	249
USB port.....	93
Using this manual .....	3

## V

Valet mode.....	110
Vauxhall Connect.....	119
Vehicle battery .....	217
Vehicle checks.....	213
Vehicle data.....	258
Vehicle data recording and privacy.....	268
Vehicle dimensions .....	262
Vehicle identification number ...	256
Vehicle jack.....	230
Vehicle locator lighting.....	129
Vehicle messages .....	114
Vehicle personalisation .....	115
Vehicle security.....	34
Vehicle specific data .....	3
Vehicle storage.....	212
Vehicle tools.....	230
Vehicle unlocking .....	6
Ventilation.....	138

## W

Warning chimes .....	114
Warning lights.....	97
Warning triangle .....	84
Washer and wiper systems .....	13
Washer fluid .....	216
Wheel changing .....	238
Wheel covers .....	235
Wheels and tyres .....	231

Windows.....	40
Windscreen.....	40
Windscreen wiper and washer ...	90
Winter tyres .....	231
Wiper blade replacement .....	219

Copyright by Vauxhall Motors Ltd.

The information contained in this publication is effective as of the date indicated below. Vauxhall Motors Ltd. reserves the right to make changes to the technical specifications, features and design of the vehicles relative to the information contained in this publication, as well as changes to the publication itself.

Edition: December 2020, Vauxhall Motors Ltd.

Printed on chlorine-free bleached paper.

ID-VCBEORIE2012-en

