



# Grandland

Owner's Manual



# Contents

<b>Emergency numbers</b>		
<b>For emergency service call the Vauxhall Incident Manager</b>		<b>0800 55 33 88 (Free Linkline)*</b>
<b>Vauxhall Assistance General Enquiries</b>		<b>0845 7565 565</b>
<b>You will need to provide:</b>	Vehicle registration number	Model and colour of your Vauxhall
	Contact telephone number	Details of your precise location

\* Calls may be chargeable from mobile phones

Introduction .....	2
Keys, doors and windows .....	6
Seats, restraints .....	30
Storage .....	54
Instruments and controls .....	64
Lighting .....	96
Climate control .....	106
Driving and operating .....	115
Vehicle care .....	201
Service and maintenance .....	241
Technical data .....	247
Customer information .....	261
Index .....	270

# Introduction

Fuel	Designation	<input type="text"/>		
Engine oil	Grade	<input type="text"/>		
	Viscosity	<input type="text"/>		
Tyre pressure	Tyre size		Front	Rear
	Summer tyres	<input type="text"/>	<input type="text"/>	<input type="text"/>
	Winter tyres	<input type="text"/>	<input type="text"/>	<input type="text"/>
Weights	Gross vehicle weight rating	<input type="text"/>		
	- Kerb weight, basic model	<input type="text"/>		
	= Loading	<input type="text"/>		

## Vehicle specific data

Please enter your vehicle's data on the previous page to keep it easily accessible.

Please refer to the sections "Service and maintenance", "Technical data", the vehicle's identification plate and national registration documents.

## Introduction

Your vehicle is a designed combination of advanced technology, safety, environmental friendliness and economy.

Some functions are only operational when ignition is switched on, when combustion engine is running or when electric engine is ready.

Make sure your passengers are aware of the possible risk of accident and injury which may result from improper use of the vehicle.

You must always comply with the specific laws and regulations of the country that you are in. These laws may differ from the information in this Owner's Manual.

Disregarding the description given in this manual may affect your warranty.

When this Owner's Manual refers to a workshop visit, we recommend your Vauxhall Authorised Repairer.

All Vauxhall Authorised Repairers provide first-class service at reasonable prices. Experienced mechanics trained by Vauxhall work according to specific Vauxhall instructions.

The customer literature pack should always be kept ready to hand in the vehicle.

## Using this manual

- This manual describes all options and features available for this model. **Certain descriptions, including those for display and menu functions, may not apply to your vehicle due to model variant, country specifications, special equipment or accessories.**
- The "In brief" section will give you an initial overview.

- The table of contents at the beginning of this manual and within each section shows where the information is located.
- The index will enable you to search for specific information.
- This Owner's Manual depicts left-hand drive vehicles. Operation is similar for right-hand drive vehicles.
- The Owner's Manual uses the engine identifier code. The corresponding sales designation and engineering code can be found in the section "Technical data".
- Directional data, e.g. left or right, or front or back, always relate to the direction of travel.
- Displays may not support your specific language.
- Display messages and interior labelling are written in **bold** letters.

## Danger, Warnings and Cautions

### **⚠ Danger**

Text marked **⚠ Danger** provides information on risk of fatal injury. Disregarding this information may endanger life.

### **⚠ Warning**

Text marked **⚠ Warning** provides information on risk of accident or injury. Disregarding this information may lead to injury.

### **Caution**

Text marked **Caution** provides information on possible damage to the vehicle. Disregarding this information may lead to vehicle damage.

## Symbols

Page references are indicated with ⇨.  
⇨ means "see page".

Page references and index entries refer to the indented headings given in the section table of content.

Thank you for choosing a Vauxhall.

We wish you many hours of pleasurable driving.

**Your Vauxhall Team**



## Keys, doors and windows

<b>Keys, locks</b> .....	<b>6</b>
Keys .....	6
Radio remote control .....	7
Electronic key system .....	8
Central locking system .....	9
Automatic locking .....	13
Child locks .....	14
<b>Doors</b> .....	<b>15</b>
Load compartment .....	15
<b>Vehicle security</b> .....	<b>20</b>
Anti-theft locking system .....	20
Anti-theft alarm system .....	20
Immobiliser .....	22
<b>Exterior mirrors</b> .....	<b>22</b>
Convex shape .....	22
Electric adjustment .....	22
Folding mirrors .....	23
Heated mirrors .....	23
<b>Interior mirrors</b> .....	<b>24</b>
Manual anti-dazzle .....	24
Automatic anti-dazzle .....	24
<b>Windows</b> .....	<b>25</b>
Windscreen .....	25

Power windows .....	25
Heated rear window .....	27
Heated windscreen .....	27
Sun visors .....	28
Roller blinds .....	28
<b>Roof</b> .....	<b>28</b>
Glass panel .....	28

## Keys, locks

### Keys

<b>Caution</b>
Do not attach heavy or bulky items to the ignition key.

### Replacement keys

The key number is specified on a detachable tag.

The key number must be quoted when ordering replacement keys as it is a component of the immobiliser system.

Locks ⇨ 237.

Central locking ⇨ 9.

Starting the engine ⇨ 118.

Radio remote control ⇨ 7.

Electronic key ⇨ 8.

The code number of the adapter for the locking wheel nuts is specified on a card. It must be quoted when ordering a replacement adapter.

Wheel changing ⇨ 228.



### Key with foldaway key section



Press button to extend. To fold the key, first press the button.

### Lock cylinders

Designed to free-wheel if they are forcefully rotated without the correct key or if the correct key is not fully inserted. To reset, turn cylinder with the correct key until its slot is vertical, remove key then re-insert it. If the cylinder still free-wheels, turn the key through 180° and repeat operation.

### Radio remote control



Enables operation of the following functions via the use of the remote control buttons:

- central locking system ⇨ 9
- anti-theft locking system ⇨ 20
- anti-theft alarm system ⇨ 20
- tailgate unlocking and opening
- power windows ⇨ 25
- mirrors folding ⇨ 23

The remote control has a range of up to 100 m, but may also be much less due to external influences. The hazard warning flashers confirm operation.

Handle with care, protect from moisture and high temperatures and avoid unnecessary operation.

### Replacing battery in radio remote control

Replace the battery as soon as the range reduces.



Batteries do not belong in household waste. They must be disposed of at an appropriate recycling collection point.

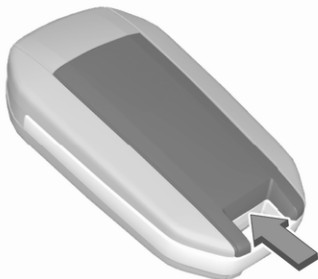

1. Remove the back cover from the remote control.
2. Extract the flat battery from its location.
3. Replace battery with a battery of the same type. Pay attention to the installation position.
4. Clip the back cover in place.

### Fault

If the central locking system cannot be operated with the radio remote control, the cause may be one of the following:

- Fault in radio remote control.
- Electronic key is out of reception range.
- The battery voltage is too low.
- Overload of the central locking system by operating at frequent intervals, the power supply is interrupted for a short time.
- Interference from higher-power radio waves from other sources.

Manual unlocking ⇨ 9.

### Electronic key system



Enables a keyless operation of the following functions:

- central locking system ⇨ 9
- power tailgate ⇨ 15
- ignition switching on and starting the engine ⇨ 118

The electronic key simply needs to be on the driver's person.

Additionally, the electronic key includes the functionality of the radio remote control ⇨ 7.

Handle with care, protect from moisture and high temperatures and avoid unnecessary operation.

**Notice**

To save battery power, the keyless functions are set to stand-by after 21 days of non-use. To reactivate the functions, press a button on the electronic key.

**Replacing battery in electronic key**

Replace the battery as soon as the system no longer operates properly or the range is reduced. The need for battery replacement is indicated by a message in the Driver Information Centre ⇨ 91.



Batteries do not belong in household waste. They must be disposed of at an appropriate recycling collection point.



1. Remove the cover.
2. Extract the flat battery from its location.
3. Replace battery with a battery of the same type. Pay attention to the installation position.
4. Clip the cover in place.

**Fault**

If the central locking cannot be operated or the engine cannot be started, the cause may be one of the following:

- Fault in electronic key.
- Electronic key is out of reception range.

- The battery voltage is too low.
- Overload of the central locking system by operating at frequent intervals, the power supply is interrupted for a short time.
- Interference from higher-power radio waves from other sources.

To rectify the cause of the fault, change the position of the electronic key.

Manual unlocking ⇨ 9.

**Central locking system**

Unlocks and locks doors, load compartment and fuel filler flap.

A pull on an interior door handle unlocks the respective door. Pulling the handle once more opens the door.

**Notice**

In the event of an accident in which airbags or belt pretensioners are deployed, the vehicle is automatically unlocked.

**Notice**

A short time after unlocking with the remote control or electronic key, the doors are being locked automatically

if no door has been opened. A precondition is that the setting is activated in the Info Display ↗ 88.



### Remote control operation

#### Unlocking



Press .

Unlocking mode can be set in the Info Display. Two settings are selectable:

- All doors, load compartment and fuel filler flap will be unlocked by pressing  once.
- Only the driver's door and fuel filler flap will be unlocked by pressing  once. To unlock all doors, load compartment and fuel filler flap, press  twice.

Select the relevant setting in the Info Display.

Info Display ↗ 88.

#### Unlocking the tailgate

Press  longer to unlock the tailgate only.

Unlocking and opening the tailgate  
↗ 15.

#### Locking

Close doors, load compartment and fuel filler flap.



Press .

If the vehicle is not closed properly, the central locking system will not work.

#### Confirmation

Operation of the central locking system is confirmed by the hazard warning flashers. A precondition is that the setting is activated in the Info Display ↗ 88.

## Electronic key system operation



The electronic key must be outside the vehicle, within a range of approx. 1 m of the relevant door side.

## Unlocking

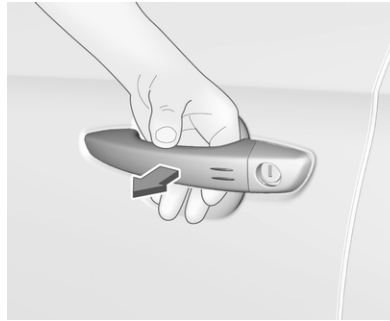

Pass a hand behind the door handle of a front door to unlock the vehicle or press the tailgate button.

Unlocking mode can be set in the Info Display. Two settings are selectable:

- Only the driver's door and fuel filler flap will be unlocked by passing a hand behind the driver's door handle.

- All doors, load compartment and fuel filler flap will be unlocked by passing a hand behind the passenger's door handle or by pressing the tailgate button.
- Only the tailgate will be unlocked by pressing the tailgate button.

Info Display ⇨ 88.

## Locking

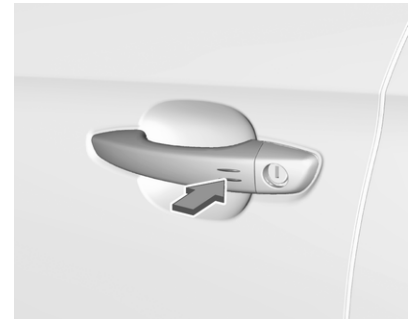

Press marking of the front door handles.

Entire vehicle will be locked.

If the vehicle is not closed properly, the electronic key remains in the vehicle or the ignition is not off, locking will not be permitted and a warning chime sounds.

Keep the hand behind the door handle or keep the tailgate button pressed to close the windows.

### Unlocking and opening the tailgate

The tailgate can be unlocked and opened hands-free by pushing the touchpad under the tailgate moulding when the electronic key is in range. The doors remain locked.

Load compartment ↗ 15.

### Operation with buttons on the electronic key



The central locking system can also be operated with the buttons on the electronic key.

Press  to unlock.

Press  to lock.

Press  longer to unlock and open only the power tailgate.

Remote control operation ↗ 9.

### Confirmation

Operation of central locking system is confirmed by the hazard warning flashers. A precondition is that the setting is activated in the Info Display ↗ 88.

### Central locking button

Locks or unlocks all doors, the load compartment and fuel filler flap from inside the passenger compartment.



Press  to lock. The LED in the button illuminates.

Press  again to unlock. The LED in the button extinguishes.

### Operation with the key in case of a central locking system fault

In case of a fault, e.g. vehicle battery or remote control / electronic key battery is discharged, the left front door can be locked or unlocked with the mechanical key.

#### Manual unlocking

Electronic key: press and hold the latch to extract the integral key.

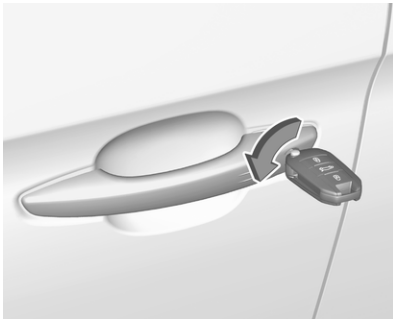

Manually unlock the left front door by inserting and turning the key in the lock cylinder.

The other doors can be opened by pulling the interior handle. The load compartment and fuel filler flap will possibly not be unlocked.

By switching on the ignition, the anti-theft locking system is deactivated.

#### Manual locking

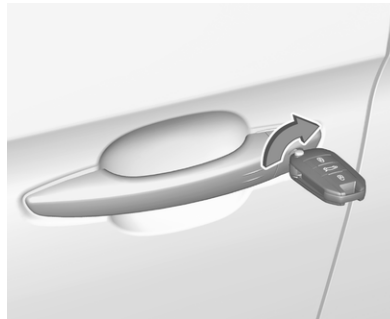

Manually lock the left front door by inserting and turning the key in the lock cylinder.



To lock the other doors, remove the black cover by using a key.

Insert key carefully and move to the inner side of the door without turning the key.

Remove key and attach black cover.

The fuel filler flap and tailgate are possibly not locked.

#### Automatic locking

##### Automatic locking after driving off

This system allows automatic locking of the doors and tailgate as soon as the speed of the vehicle exceeds a certain speed.

If one of the doors or the tailgate is open, the automatic central locking does not take place. This is signalled by the sound of the locks rebounding, accompanied by illumination of  in the Driver Information Display, an audible signal and the display of an alert message.



This function can be activated or deactivated at any time. With the ignition on, press  until an audible signal starts and a corresponding message is displayed.

The state of the system stays in memory when switching off the ignition.

### Automatic relock after unlocking

This feature automatically locks all doors, load compartment and fuel filler flap a short time after unlocking with the remote control or electronic key, provided no door has been opened.

### Child locks

#### Warning

Use the child locks whenever children are occupying the rear seats.

### Mechanical child locks



Turn the red child lock in the rear door to the horizontal position by using a key. The door cannot be opened from the inside.

To deactivate, turn the child lock to the vertical position.



## Electric child locks



Remotely operated system to prevent opening of the rear doors via the interior door handles and the use of the rear power windows.

### Switching on

Press . The indicator light in the button comes on, accompanied by a confirmation message. This indicator light remains on until the child lock is switched off.

### Switching off

Press  again. The indicator light on button goes off, accompanied by a confirmation message.

## Doors

### Load compartment

### Tailgate

#### Opening

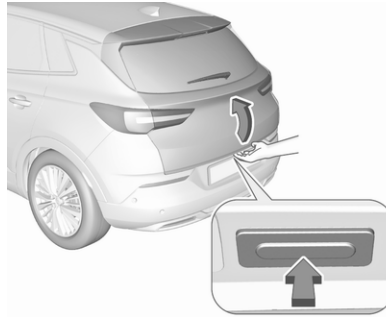

After unlocking, press the tailgate button and open the tailgate.

#### Closing



Use the interior handle.

Do not push the touchpad whilst closing as this will unlock the tailgate again.

Central locking system ⇨ 9.



## Power tailgate

### ⚠ Warning

Take care when operating the power tailgate. Risk of injury, particularly to children.

Keep a close watch on the movable tailgate when operating. Ensure that nothing becomes trapped during operating and no one is standing within the moving area.

The power tailgate can be operated by:

- Pressing  longer on the electronic key.
- Hands-free operation with motion sensor below the rear bumper.
- The tailgate button and  in the open tailgate.

On vehicles with automatic transmission, the tailgate can only be operated when the vehicle is stationary and automatic transmission in **P**.

The turn lights flash and a chime sounds when the power tailgate is operating.

### Notice

Operating the power tailgate does not operate the central locking system. To open the tailgate with the button on the electronic key, or with the tailgate button or via hands-free operation, it is not necessary to unlock the vehicle. A precondition is that the electronic key is outside the vehicle, within a range of approx. 1 m of the tailgate.

Do not leave the electronic key in the load compartment.

Lock the vehicle after closing if it was unlocked previously.

Central locking system  9.

## Operation with the electronic key



Press  longer to open or close the tailgate.

### Hands-free operation



To open or close the tailgate move the foot below the rear bumper back and forth in the area below the number plate. Do not hold the foot longer or move too slow below the bumper. The electronic key must be outside the vehicle, within a range of approx. 1 m of the tailgate.

Activation or deactivation of hands-free operation can be set in the Info Display.

Info Display ⇨ 88.

### ⚠ Danger

Do not touch any vehicle parts below the vehicle during hands-free operation. There is a risk of injury from hot engine parts.

### Automatic locking after hands-free operation

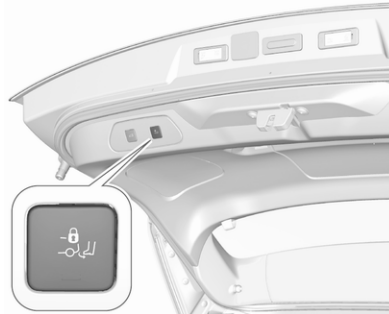

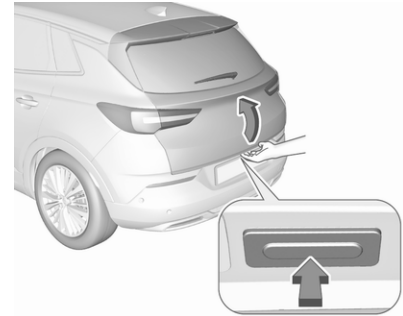

Press button **القفل** in the open tailgate, the whole vehicle will be locked after hands-free closing of the tailgate.

### Operation with the tailgate button



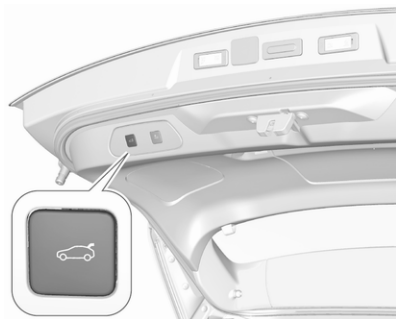

To open the tailgate, press the tailgate button until the tailgate starts to move. If the vehicle is locked, the electronic key must be outside the vehicle, within a range of approx. 1 m of the tailgate.



To close, press  in the open tailgate until the tailgate starts to move.

### Stop or change direction of movement

Stop movement of the tailgate immediately:

- press  longer on the electronic key, or
- press the tailgate button, or
- press  on the open tailgate

Pressing one of the switches again will reverse the direction of movement.

### Adjust reduced opening height

1. Open power tailgate with any operation switch.
2. Stop movement at the desired height by pressing . If required, manually move the stopped tailgate to the desired position.

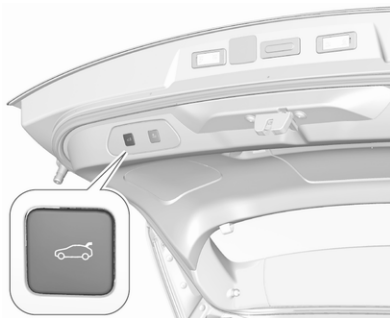

3. Press and hold the button  on the inside of the open tailgate for 3 seconds.

### Notice

Adjusting opening height should be programmed at ground level.

A chime sound indicates the new setting and the turn lights will flash. The reduced height can only be set at an opening angle of above 30°.

To delete reduced height position, open tailgate in half position and press  for 3 seconds.

The tailgate can only be held open if a minimum height is exceeded (minimum opening angle from 30°). The opening height cannot be programmed below that height.

### Safety function

If the power tailgate encounters an obstacle during opening or closing, the direction of movement will automatically be reversed slightly. Multiple obstacles in one power cycle will deactivate the function. In this case, close or open the tailgate manually.

The power tailgate has pinch sensors on the side edges. If the sensors detect obstacles between tailgate and chassis, the tailgate will open, until it is activated again or closed manually.

The safety function is indicated by a warning chime.

Remove all obstacles before resuming normal power operation.

If the vehicle is equipped with factory-fitted towing equipment and a trailer is electrically connected, the power tailgate can only be opened with the tailgate button or closed with  in the open tailgate. Ensure that there are no obstacles in the moving area.

### Overload

If the power tailgate is repeatedly operated at short intervals, the function is disabled for some time. Move tailgate manually into end position to reset the system.

### Initialising power tailgate

If the power tailgate cannot be operated automatically (e.g. after disconnecting the vehicle battery), a warning message is displayed in the Driver Information Centre.

Activate electronics as follows:

1. Open tailgate manually.
2. Close tailgate manually.
3. Switch on ignition.

Seek the assistance of a workshop if the problem is not solved.

### General hints for operating tailgate

#### Danger

Do not drive with the tailgate open or ajar, e.g. when transporting bulky objects, since toxic exhaust gases, which cannot be seen or smelled, could enter the vehicle. This can cause unconsciousness and even death.

#### Caution

Before opening the tailgate, check overhead obstructions, e.g. a garage door, to avoid damage to the tailgate. Always check the moving area above and behind the tailgate.

#### Notice

The installation of certain heavy accessories onto the tailgate may affect its ability to remain open.

#### Notice

The operation of the power tailgate is disabled under low vehicle battery conditions. In this case, the tailgate may not even be manually operable.

#### Notice

With the power tailgate disabled and all doors unlocked, the tailgate can only be operated manually. In this event, manually closing the tailgate requires significantly greater force.

#### Notice

At low outside temperatures the tailgate may not open fully by itself. In this case lift the tailgate manually to its normal end position.

## Vehicle security

### Anti-theft locking system

#### ⚠ Warning

Do not use the system if there are people in the vehicle! The doors cannot be unlocked from the inside.

The system deadlocks all the doors. All doors must be closed otherwise the system cannot be activated.

Unlocking the vehicle disables the mechanical anti-theft locking system. This is not possible with the central locking button.

#### Activating



Press Ⓛ on the radio remote control twice within 5 seconds.

#### Anti-theft alarm system

The anti-theft alarm system is combined with the central locking system.

It monitors:

- doors, tailgate, bonnet
- passenger compartment including adjoining load compartment

- vehicle inclination, e.g. if it is raised
- ignition

#### Activation

All doors, the load compartment and the engine compartment must be closed and the electronic key must not remain in the vehicle.

- Radio remote control: activated 45 seconds after locking the vehicle by pressing Ⓛ once.
- Electronic key system: activated 45 seconds after locking the vehicle by pressing with a finger or thumb on one of the front door handles at the markings.

If a door, the tailgate or the bonnet is not properly closed, the vehicle is not locked. However, the anti-theft alarm is self-activated after 45 seconds.



#### Notice

Changes to the vehicle interior such as the use of seat covers and open windows, could impair the function of passenger compartment monitoring.

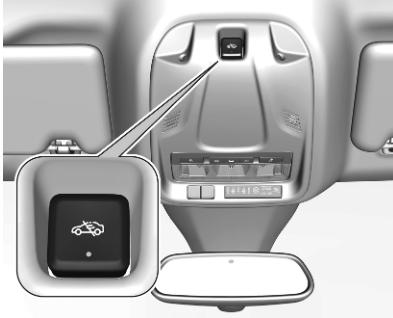
### Activation without monitoring of passenger compartment and vehicle inclination



Switch off the monitoring of passenger compartment and vehicle inclination when animals are being left in the vehicle, because of high volume ultrasonic signals or movements triggering the alarm. Also switch off when the vehicle is on a ferry or train.

1. Close tailgate, bonnet, windows.
2. Switch off ignition and press  within 10 seconds until the LED in the button  illuminates.

3. Close doors.
4. Activate the anti-theft alarm system.

### Indication

LED in the  button flashes if the anti-theft alarm system is activated. The hazard warning lights illuminates for a few seconds.

### Deactivation

Radio remote control: Unlocking the vehicle by pressing  deactivates the anti-theft alarm system.

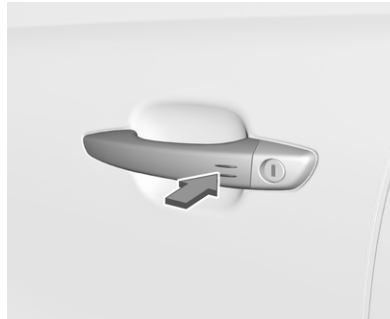

Electronic key system: Unlocking the vehicle by pressing on one of the front door handles at the markings deactivates the anti-theft alarm system.

The electronic key must be outside the vehicle, within a range of approx. 1 m of the relevant door side.

The system is not deactivated by unlocking the driver's door with the key or with the central locking button in the passenger compartment.

The hazard warning lights flash for a few seconds.

### Alarm

When triggered, the alarm siren sounds and the hazard warning lights flash simultaneously. The number and duration of alarm signals are stipulated by legislation.

The anti-theft alarm system can be deactivated by pressing , by pressing on one of the front door handles at the markings with electronic key system or switching on the ignition.

A triggered alarm, which has not been interrupted by the driver, will be indicated by the LED in the button . The LED will flash quickly the next time the vehicle is unlocked with the radio remote control.

If the battery has been reconnected (e.g. after maintenance work), wait for 10 minutes to restart the engine.

### Fault

If the LED in the button  illuminates permanently when switching on the ignition, seek the assistance of a workshop.

### Locking the vehicle without activation of the anti-theft alarm

Lock the vehicle by locking the driver's door with the integral key.

### Immobiliser

The system is part of the ignition switch and checks whether the vehicle is allowed to be started with the key being used.

The immobiliser is activated automatically after the key has been removed from the ignition switch.

#### Notice

Radio Frequency Identification (RFID) tags may cause interference with the key. Do not have it placed near the key when starting the vehicle.

#### Notice

The immobiliser does not lock the doors. Always lock the vehicle after leaving it  $\diamond$  9.

Switch on the anti-theft alarm system  $\diamond$  20.

Emergency operation of electronic key  $\diamond$  117.

## Exterior mirrors

### Convex shape

The shape of the mirror makes objects appear smaller, which will affect the ability to estimate distances.

Side blind spot alert  $\diamond$  168.

### Electric adjustment

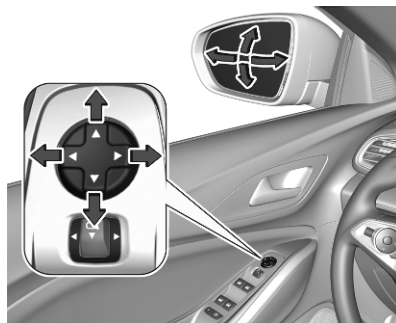

Select the relevant exterior mirror by pushing the mirror button to the left or right.

Then swivel the control to adjust the mirror.



## Folding mirrors



For pedestrian safety, the exterior mirrors will swing out of their normal mounting position if they are struck with sufficient force. Reposition the mirror by applying slight pressure to the mirror housing.

## Electric folding



Pull mirror button rearwards. Both exterior mirrors will fold.

Pull mirror button rearwards again to return both exterior mirrors to their original position.

If an electrically folded mirror is manually extended, pulling mirror button rearwards will only electrically extend the other mirror.

## Automatic folding

When the vehicle is unlocked, the mirrors swing to their normal mounting position. When the vehicle is locked, the mirrors are folded down.

To enable or disable automatic folding of the exterior mirrors, consult a workshop.

## Heated mirrors

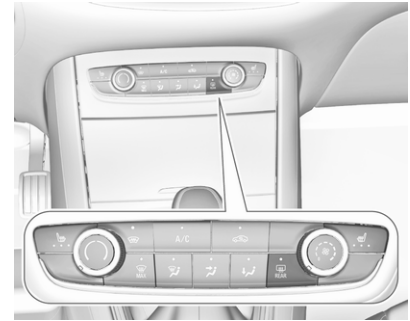

Operated by pressing .

Heating works with the engine running and is switched off automatically after a short time.

Heated rear window  27.

## Interior mirrors

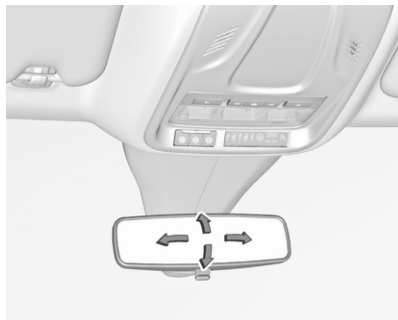

To adjust the mirror, move the mirror housing in the desired direction.

## Manual anti-dazzle



To reduce dazzle, adjust the lever on the underside of the mirror housing.

## Automatic anti-dazzle



Dazzle from following vehicles is automatically reduced, when driving in the dark.

## Windows

### Windscreen

#### Windscreen stickers



Do not attach stickers such as toll road stickers or similar on the windscreen in the area of the interior mirror. Keep the sensor free from dust, dirt and ice. Otherwise the detection zone of the rain sensor / light sensor and the view area of the camera in the mirror housing could be restricted.

Sensors ⇨ 69, ⇨ 97

### Windscreen replacement

#### Caution

If the vehicle has a front-looking camera sensor for the driver assistance systems, it is very important that any windscreen replacement is performed accurately according to Vauxhall specifications. Otherwise, these systems may not work properly and there is a risk of unexpected behaviour and / or messages from these systems.

### Power windows

#### ⚠ Warning

Take care when operating the power windows. Risk of injury, particularly to children.

If there are children on the rear seats, switch on the child safety system for the power windows.

Keep a close watch on the windows when closing them. Ensure that nothing becomes trapped in them as they move.

Switch on ignition to operate power windows.

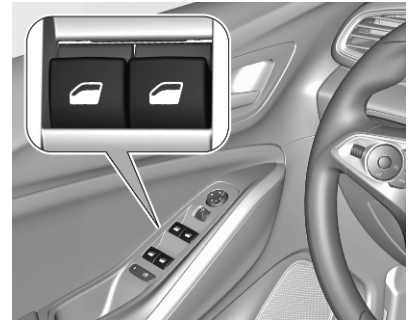

Operate the switch for the respective window by pushing to open or pulling to close.

Pushing or pulling gently to the first detent: window moves up or down as long as the switch is operated.

Pushing or pulling firmly to the second detent then releasing: window moves up or down automatically with safety function enabled. To stop movement, operate the switch once more in the same direction.

### Safety function



If the window glass encounters resistance above the middle of the window during automatic closing, it is immediately stopped and opened again.

### Override safety function

In the event of closing difficulties due to frost or the like, switch on the ignition, then pull the switch to the first detent and hold. The window moves up without safety function enabled. To stop movement, release the switch.

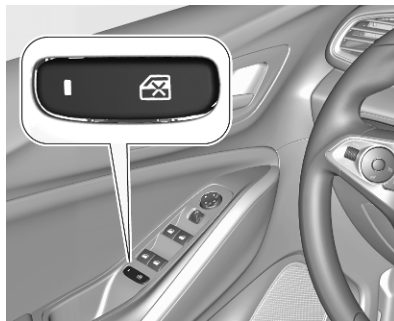
### Child safety system for rear windows



Press  to deactivate rear door power windows; the LED illuminates. To activate, press  again.

### Operating windows from outside

The windows can be operated remotely from outside the vehicle.

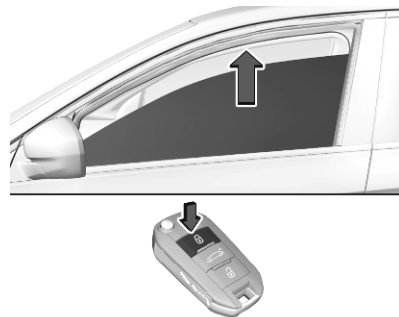

Press and hold  to close windows. Release button to stop window movement.

If the windows are fully closed, the hazard warning lights will flash twice.

### Overload

If the windows are repeatedly operated within short intervals, the window operation is disabled for some time.

## Initialising the power windows

If the windows cannot be closed automatically (e.g. after disconnecting the vehicle battery), a warning message is displayed in the Driver Information Centre.

Vehicle messages ⇨ 91.

Activate the window electronics as follows:

1. Close doors.
2. Switch on ignition.
3. Pull switch until the window is closed and keep pulling for additional 2 seconds.
4. Push switch until the window is completely open and keep pushing for additional 2 seconds.
5. Repeat for each window.

## Heated rear window

Operated by pressing  together with heated exterior mirrors.

Heating works with the engine running and is switched off automatically after a short time.

Depending on climate control system,  is located at a different position.

## Vehicles with heating and ventilation system or air conditioning system

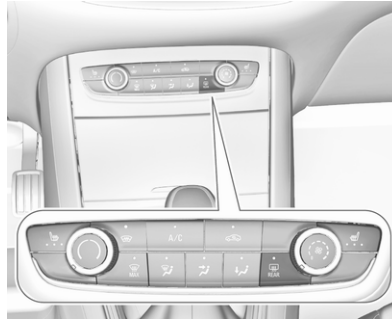

## Vehicles with electronic climate control system

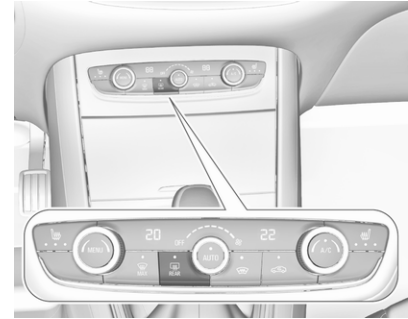

## Heated windscreen

Operated by pressing . LED in button illuminates.

Heating works with the engine running and is switched off automatically after a short time.

Depending on climate control system,  is located at a different position.

### Vehicles with electronic climate control system

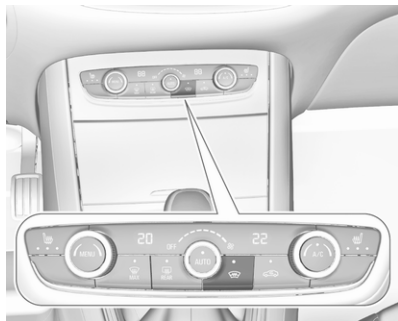

### Vehicles with air conditioning system

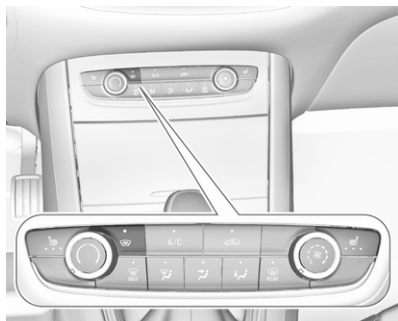

### Sun visors

The sun visors can be folded down or swivelled to the side to prevent dazzling.

If the sun visors have integral mirrors, the mirror covers should be closed when driving.

A ticket holder is located on the backside of the sun visor.

### Roller blinds

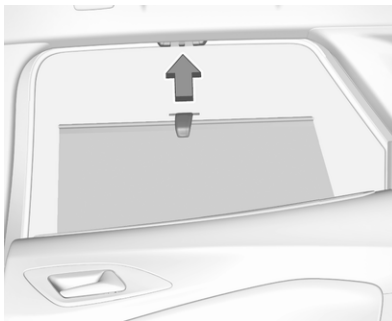



To reduce sunlight at the second row seats, pull the blind upwards using the grip and engage it at the top of the door frame.

## Roof

### Glass panel

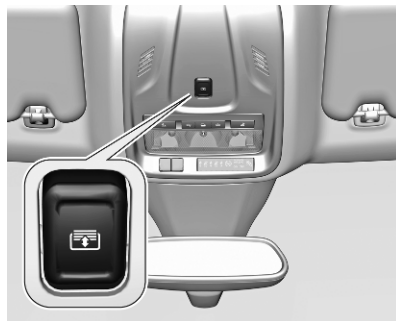
#### Sunblind



Press  gently to the first detent at the rear: the sunblind is opened as long as the switch is operated.

Press  firmly to the second detent and then release at the rear: the sunblind is opened as long as the switch is operated.

Press  gently to the first detent at the front: the sunblind is closed as long as the switch is operated.

Press  firmly to the second detent and then release at the front: the sunblind is closed as long as the switch is operated.

### Safety function



If the sunblind encounters resistance during automatic closing, it is immediately stopped and opened again.

### Function standby



In ignition switch position 1 the sunblind is operational ⇨ 116.

### Initialising after a power failure

After a power failure, it may only be possible to operate the sunblind to a limited extent. Initialise the system as follows:

1. Turn key in ignition switch to position 1.
2. Press  twice gently to the first detent at the rear, the sunblind opens slightly.
3. Immediately press  twice gently to the first detent at the front, the sunblind closes slightly.

After step 3 the sunblind is in initialising mode without safety function.

4. Press  gently to the first detent at the rear until the sunblind is completely opened.
5. Press  gently to the first detent at the front until the sunblind is completely closed.

After this procedure, the sunblind is initialised with safety function activated.

When  is pressed firmly to the second detent during initialising, the procedure is cancelled.

## Seats, restraints

<b>Head restraints</b> .....	<b>30</b>
<b>Front seats</b> .....	<b>31</b>
Seat position .....	31
Manual seat adjustment .....	32
Power seat adjustment .....	34
Armrest .....	36
Heating .....	36
Ventilating .....	36
<b>Rear seats</b> .....	<b>37</b>
Armrest .....	37
Heating .....	37
<b>Seat belts</b> .....	<b>37</b>
Three-point seat belt .....	38
<b>Airbag system</b> .....	<b>40</b>
Front airbag system .....	44
Side airbag system .....	44
Curtain airbag system .....	45
Airbag deactivation .....	45
<b>Child restraints</b> .....	<b>47</b>
Child restraint systems .....	47
Child restraint installation locations .....	50

## Head restraints

### Position

#### ⚠ Warning

Only drive with the head restraint set to the proper position.

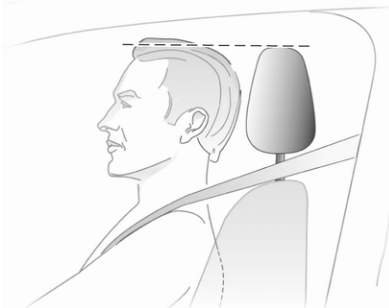

The upper edge of the head restraint should be at upper head level. If this is not possible for extremely tall people, set to highest position, and set to lowest position for small people.

## Adjustment

### Head restraints on front seats

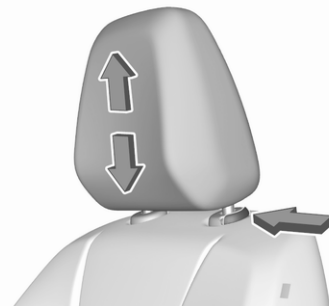

### Height adjustment

Pull the head restraint upwards or press the catch to release and push the head restraint downwards.



## Head restraints on rear seats

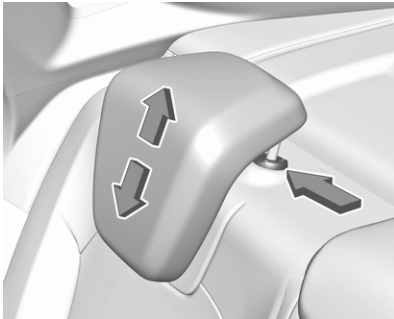

### Height adjustment

Pull the head restraint upwards or press the catch to release and push the head restraint downwards.

### Removal

Press catch, pull the respective head restraint upwards and remove.

## Front seats

### Seat position

#### ⚠ Warning

Only drive with the seat correctly adjusted.

#### ⚠ Warning

Never adjust seats while driving as they could move uncontrollably.

#### ⚠ Danger

Do not sit closer than 25 cm to the steering wheel, to permit safe airbag deployment.

#### ⚠ Warning

Never store any objects under the seats.



- Sit with buttocks as far back against the backrest as possible. Adjust the distance between the seat and the pedals so that legs are slightly angled when pressing the pedals. Slide the front passenger seat as far back as possible.
- Set seat height high enough to have a clear field of vision on all sides and of all display instruments. There should be at least one hand of clearance between head and the roof frame. Your thighs should rest lightly on the seat without pressing into it.

- Sit with shoulders as far back against the backrest as possible. Set the backrest rake so that it is possible to easily reach the steering wheel with arms slightly bent. Maintain contact between shoulders and the backrest when turning the steering wheel. Do not angle the backrest too far back. We recommend a maximum rake of approx. 25°.
- Adjust seat and steering wheel in a way that the wrist rests on top of the steering wheel while the arm is fully extended and shoulders are on the backrest.
- Adjust the steering wheel ↻ 68.
- Adjust the head restraint ↻ 30.
- Adjust the height of the seat belt ↻ 38.
- Adjust the thigh support so that there is a space approx. two fingers wide between the edge of the seat and the hollow of the knee.
- Adjust the lumbar support so that it supports the natural shape of the spine.

## Manual seat adjustment

Drive only with engaged seats and backrests.

### Longitudinal adjustment

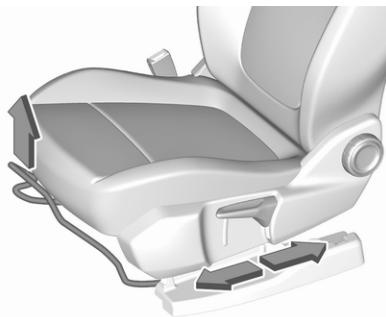

Pull handle, slide seat, release handle. Try to move the seat back and forth to ensure that the seat is locked in place.

### Backrest inclination



Turn handwheel. Do not lean on backrest when adjusting.

### Seat height

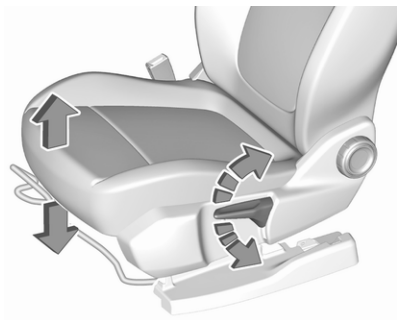

Lever pumping motion

up : seat higher  
down : seat lower

### Seat inclination

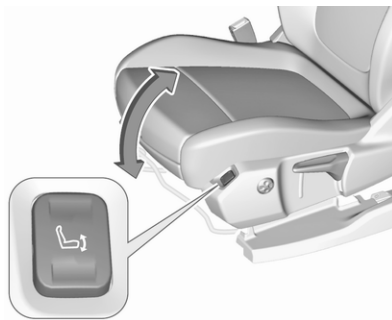

Press switch

at the rear : front end higher  
at the front : front end lower

### Lumbar support

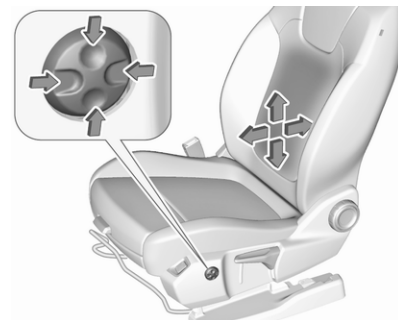

Adjust lumbar support using the four-way switch to suit personal requirements.

Moving support up and down: push switch up or down.

Increasing and decreasing support: push switch forwards or backwards.

### Adjustable thigh support

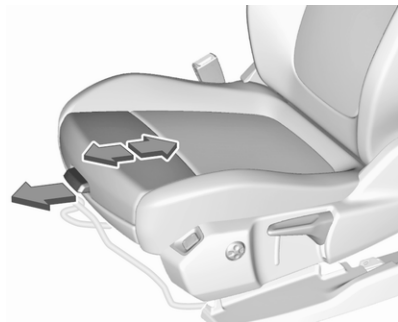

Pull the lever and slide the thigh support.

### Power seat adjustment

#### **⚠ Warning**

Care must be taken when operating the power seats. There is a risk of injury, particularly for children. Objects could become trapped.

Keep a close watch on the seats when adjusting them. Vehicle passengers should be informed accordingly.

### Longitudinal adjustment

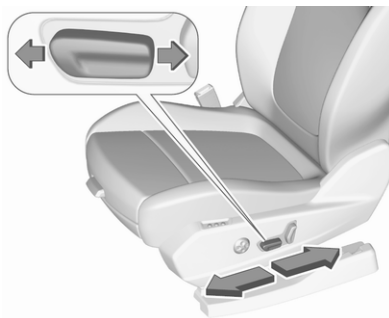

Move switch forwards / backwards.

### Seat height

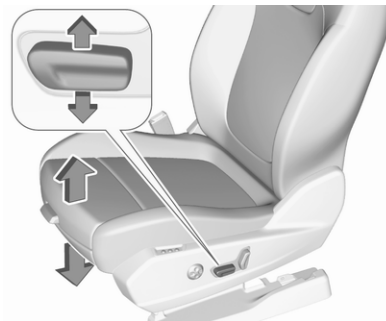

Move switch upwards / downwards.

### Seat inclination



Move front of switch upwards / downwards.

### Backrest inclination



Turn switch forwards / backwards.  
Lumbar support, adjustable thigh support, see manual seat adjustment ⇨ 32.

### Memory function for power seat adjustment

Two different driver's seat settings can be stored.  
Info Display ⇨ 88.



#### Storing memory position

- Adjust driver's seat to desired position.
- Press and hold **M** and **1** or **2** simultaneously until a chime sounds.

#### Recall of memory positions

Press and hold **1** or **2** until the stored seat position has been reached. Releasing the button during seat movement cancels the recall.

#### Safety function

If the driver's seat encounters resistance during movement, the recall may stop. After removing the

obstruction, press and hold the appropriate memory position button for 2 seconds. Try recalling the memory position again. If the recall does not operate, consult a workshop.

#### Overload

If the seat setting is electrically overloaded, the power supply is automatically cut-off for a short time.

#### Notice

After an accident in which airbags have been deployed, the memory function for each position button will be deactivated.

## Armrest

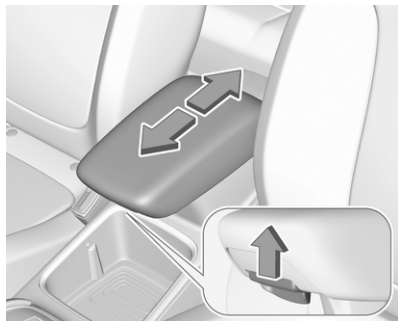

The armrest can be slid forwards by 10 cm. Pull the handle to slide the armrest. Under the armrest there is a storage compartment.

## Heating

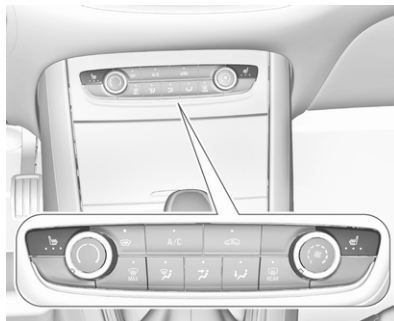

Adjust heating to the desired setting by pressing  for the respective seat one or more times. The control indicator in the button indicates the setting.

Prolonged use of the highest setting for people with sensitive skin is not recommended.

Seat heating is operational when engine is running and during an Autostop.

Stop-start system ⇨ 120.

## Ventilating

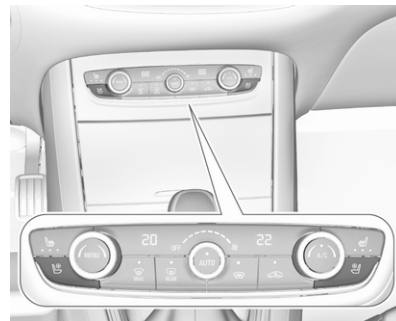

Activate ventilation by pressing  for the respective front seat.

Ventilated seats are operational when engine is running and during an Autostop.

Stop-start system ⇨ 120.

## Rear seats

### Armrest

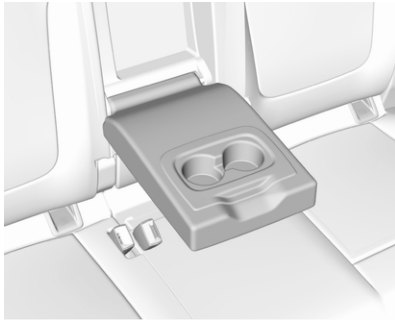

Fold armrest down. The armrest contains cupholders.

### Heating

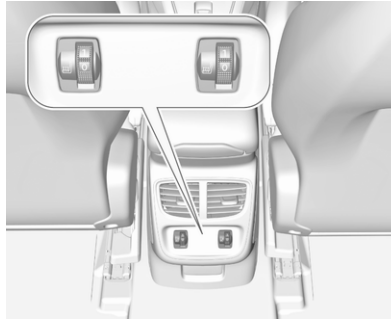

Adjust seat heating by turning thumb wheel  for the respective rear outer seat to the desired setting.

Prolonged use of the highest setting for people with sensitive skin is not recommended.

Seat heating is operational when engine is running and during an Autostop.

## Seat belts



The seat belts are locked during heavy acceleration or deceleration of the vehicle, holding the occupants in the seat position. Therefore the risk of injury is considerably reduced.

### Warning

Fasten seat belt before each trip.

In the event of an accident, people not wearing seat belts endanger their fellow occupants and themselves.

Seat belts are designed to be used by only one person at a time.

Child restraint system ⇨ 47.

Periodically check all parts of the seat belt system for damage, soiling and proper functionality.

Have damaged components replaced. After an accident, have the seat belts and triggered seat belt pretensioners replaced by a workshop.

#### Notice

Make sure that the seat belts are neither damaged by shoes or sharp-edged objects nor trapped. Prevent dirt from getting into the seat belt retractors.

#### Notice

Use the belt buckle intended for the respective seat belt when fastening in order to ensure proper functionality.

### Seat belt reminder

Each seat is equipped with a seat belt reminder, indicated by a control indicator  for the respective seat in the overhead console.

Seat belt reminder ⇨ 80.

### Seat belt force limiters

Stress on the body is reduced by the gradual release of the seat belt during a collision.

### Seat belt pretensioners

In the event of a head-on, rear-end or side-on collision of a certain severity, the front seat belts and the outer rear seat belts are tightened by seat belt pretensioners.

#### Warning

Incorrect handling (e.g. removal or fitting of seat belts) can trigger the seat belt pretensioners.

Deployment of the seat belt pretensioners is indicated by continuous illumination of control indicator .

Airbag and seat belt pretensioners ⇨ 80

Triggered seat belt pretensioners must be replaced by a workshop. Seat belt pretensioners can only be triggered once.

#### Notice

Do not affix or install accessories or other objects that may interfere with the operation of the seat belt pretensioners. Do not make any modifications to seat belt pretensioner components as this will invalidate the vehicle operating permit.

## Three-point seat belt

### Fasten





Withdraw the seat belt from the retractor, guide it untwisted across the body and insert the latch plate into the buckle. Make sure the belt fits tightly to the body while driving.

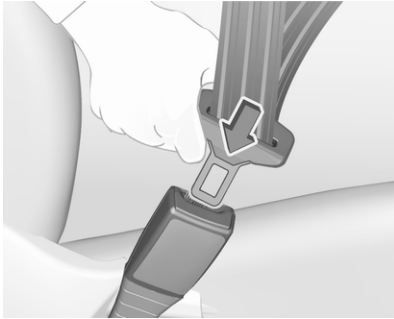

Loose or bulky clothing prevents the seat belt from fitting snugly. Do not place objects such as handbags or mobile phones between the seat belt and your body.

### Warning

The seat belt must not rest against hard or fragile objects in the pockets of your clothing.

Seat belt reminder  80.

### Height adjustment



1. Pull seat belt out slightly.
2. Press the button to disengage the height adjuster and push it upwards or downwards.



Adjust the height so that the seat belt lies across the shoulder. It must not lie across the throat or upper arm.

Do not adjust while driving.

## Unfasten

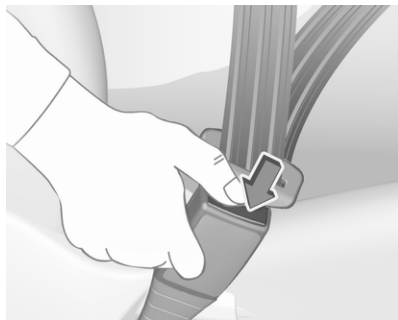

To release seat belt, press red button on seat belt buckle.

## Using seat belts while pregnant



### **⚠ Warning**

The lap belt must be positioned as low as possible across the pelvis to prevent pressure on the abdomen.

## Airbag system

The airbag system consists of a number of individual systems depending on the scope of equipment.

When triggered the airbags inflate within milliseconds. They also deflate so quickly that it is often unnoticeable during the collision.

### **⚠ Warning**

The airbag system deploys in an explosive manner, repairs must be performed by skilled personnel only.

### **⚠ Warning**

Adding accessories that change the vehicle's frame, bumper system, height, front end or side sheet metal, may keep the airbag system from working properly. The operation of the airbag system can also be affected by changing any parts of the front seats, seat belts,

airbag sensing and diagnostic module, steering wheel, instrument panel, inner door seals including the speakers, any of the airbag modules, ceiling or pillar trim, front sensors, side impact sensors or airbag wiring.

### Notice

The airbag systems and belt pretensioner control electronics are located in the centre console. Do not put any magnetic objects in this area.

Do not affix any objects onto the airbag covers and do not cover them with other materials. Have damaged covers replaced by a workshop.

Each airbag is triggered only once. Have deployed airbags replaced by a workshop. Furthermore, it may be necessary to have the steering wheel, the instrument panel, parts of the panelling, the door seals, handles and the seats replaced.

Do not make any modifications to the airbag system as this will invalidate the vehicle operating permit.

Control indicator  for airbag systems  
 ⇨ 80.

### Child restraint systems on front passenger seat with airbag systems

Warning according to ECE R94.02:



**EN:** NEVER use a rearward-facing child restraint on a seat protected by an ACTIVE AIRBAG in front of it; DEATH or SERIOUS INJURY to the CHILD can occur.

**DE:** Nach hinten gerichtete Kindersitze NIEMALS auf einem Sitz verwenden, der durch einen davor befindlichen AKTIVEN AIRBAG

geschützt ist, da dies den TOD oder SCHWERE VERLETZUNGEN DES KINDES zur Folge haben kann.

**FR:** NE JAMAIS utiliser un siège d'enfant orienté vers l'arrière sur un siège protégé par un COUSSIN GONFLABLE ACTIF placé devant lui, sous peine d'infliger des BLESSURES GRAVES, voire MORTELLES à l'ENFANT.

**ES:** NUNCA utilice un sistema de retención infantil orientado hacia atrás en un asiento protegido por un AIRBAG FRONTAL ACTIVO. Peligro de MUERTE o LESIONES GRAVES para el NIÑO.

**RU:** ЗАПРЕЩАЕТСЯ устанавливать детское удерживающее устройство лицом назад на сиденье автомобиля, оборудованном фронтальной подушкой безопасности, если ПОДУШКА НЕ ОТКЛЮЧЕНА! Это может привести к СМЕРТИ или СЕРЬЕЗНЫМ ТРАВМАМ РЕБЕНКА.

**NL:** Gebruik NOOIT een achterwaarts gericht kinderzitje op een stoel met een ACTIEVE AIRBAG ervoor, om DODELIJK of ERNSTIG LETSEL van het KIND te voorkomen.

**DA:** Brug ALDRIG en bagudvendt autostol på et forsæde med AKTIV AIRBAG, BARNET kan komme i LIVSFARE eller komme ALVORLIGT TIL SKADE.

**SV:** Använd ALDRIG en bakåtvänd barnstol på ett säte som skyddas med en framförvarande AKTIV AIRBAG. DÖDSFALL eller ALLVARLIGA SKADOR kan drabba BARNET.

**FI:** ÄLÄ KOSKAAN sijoita taaksepäin suunnattua lasten turvaistuinta istuimelle, jonka edessä on AKTIIVINEN TURVATYYNY, LAPSI VOI KUOLLA tai VAMMAUTUA VAKAVASTI.

**NO:** Bakovervendt barnesikringsutstyr må ALDRI brukes på et sete med AKTIV KOLLISJONSPUTE foran, da det kan føre til at BARNET utsettes for LIVSFARE og fare for ALVORLIGE SKADER.

**PT:** NUNCA use um sistema de retenção para crianças voltado para trás num banco protegido com um AIRBAG ACTIVO na frente do mesmo, poderá ocorrer a PERDA DE VIDA ou FERIMENTOS GRAVES na CRIANÇA.

**IT:** Non usare mai un sistema di sicurezza per bambini rivolto all'indietro su un sedile protetto da AIRBAG ATTIVO di fronte ad esso: pericolo di MORTE o LESIONI GRAVI per il BAMBINO!

**EL:** ΠΟΤΕ μη χρησιμοποιείτε παιδικό κάθισμα ασφαλείας με φορά προς τα πίσω σε κάθισμα που προστατεύεται από μετωπικό ΕΝΕΡΓΟ ΑΕΡΟΣΑΚΟ, διότι το παιδί μπορεί να υποστεί ΘΑΝΑΣΙΜΟ ή ΣΟΒΑΡΟ ΤΡΑΥΜΑΤΙΣΜΟ.

**PL:** NIE WOLNO montować fotelika dziecięcego zwróconego tyłem do kierunku jazdy na fotelu, przed którym znajduje się WŁĄCZONA PODUSZKA POWIETRZNA. Niezastosowanie się do tego zalecenia może być przyczyną ŚMIERCII lub POWAŻNYCH OBRAŻEŃ u DZIECKA.

**TR:** Arkaya bakan bir çocuk emniyet sistemini KESİNLİKLE önünde bir AKTİF HAVA YASTIĞI ile korunmakta olan bir koltukta kullanmayınız. ÇOCUK ÖLEBİLİR veya AĞIR ŞEKİLDE YARALANABİLİR.

**UK:** НІКОЛІ не використовуйте систему безпеки для дітей, що встановлюється обличчям назад, на сидінні з УВІМКНЕНОЮ ПОДУШКОЮ БЕЗПЕКИ, інакше це може призвести до СМЕРТІ чи СЕРЬОЗНОГО ТРАВМУВАННЯ ДИТИНИ.

**HU:** SOHA ne használjon hátrafelé néző biztonsági gyerekléssel előlről AKTÍV LÉGZSÁKKAL védett ülésen, mert a GYERMEK HALÁLÁT vagy KOMOLY SÉRÜLÉSÉT okozhatja.

**HR:** NIKADA nemojte koristiti sustav zadržavanja za djecu okrenut prema natrag na sjedalu s AKTIVNIM ZRAČNIM JASTUKOM ispred njega, to bi moglo dovesti do SMRTI ili OZBILJNIH OZLJEDA za DIJETE.

**SL:** NIKOLI ne nameščajte otroškega varnostnega sedeža, obrnjenega v nasprotni smeri vožnje, na sedež z

AKTIVNO ČELNO ZRAČNO  
BLAZINO, saj pri tem obstaja  
nevarnost RESNIH ali SMRTNIH  
POŠKODB za OTROKA.

**SR:** NIKADA ne koristiti bezbednosni  
sistem za decu u kome su deca  
okrenuta unazad na sedištu sa  
AKTIVNIM VAZDUŠNIM  
JASTUKOM ispred sedišta zato što  
DETE može da NASTRADA ili da se  
TEŠKO POVREDI.

**МК:** НИКОГАШ не користете детско  
седиште свртено назад на  
седиште заштитено со АКТИВНО  
ВОЗДУШНО ПЕРНИЧЕ пред него,  
затоа што детето може ДА ЗАГИНЕ  
или да биде ТЕШКО ПОВРЕДЕНО.

**BG:** НИКОГА не използвайте  
детска седалка, гледаща назад,  
върху седалка, която е защитена  
чрез АКТИВНА ВЪЗДУШНА  
ВЪЗГЛАВНИЦА пред нея - може да  
се стигне до СМЪРТ или  
СЕРИОЗНО НАРАНЯВАНЕ на  
ДЕТЕТО.

**RO:** Nu utilizați NICIODATĂ un scaun  
pentru copil îndreptat spre partea din  
spate a mașinii pe un scaun protejat  
de un AIRBAG ACTIV în fața sa;

acest lucru poate duce la DECESUL  
sau VĂTĂMAREA GRAVĂ a  
COPILULUI.

**CS:** NIKDY nepoužívejte dětský  
zádržný systém instalovaný proti  
směru jízdy na sedadle, které je  
chráněno před sedadlem AKTIVNÍM  
AIRBAGEM. Mohlo by dojít k  
VÁŽNĚMU PORANĚNÍ nebo ÚMRTÍ  
DÍTĚTE.

**SK:** NIKDY nepoužívajte detskú  
sedačku otočenú vzad na sedadle  
chránenom AKTÍVNYM AIRBAGOM,  
pretože môže dôjsť k SMRTI alebo  
VÁŽNYM ZRANENIAM DIĎAŤA.

**LT:** JOKIU BŪDU nemontuokite atgal  
atgręžtos vaiko tvirtinimo sistemas  
sėdynėje, prieš kurią įrengta AKTYVI  
ORO PAGALVĖ, nes VAIKAS GALI  
ŽŪTI arba RIMTAI SUSIŽALOTI.

**LV:** NEKĀDĀ GADĪJUMĀ  
neizmantojiet uz aiz muguri vērstu  
bērnu sēdekļiņi sēdvietā, kas tiek  
aizsargāta ar tās priekšā uzstādītu  
AKTĪVU DROŠĪBAS SPILVENU, jo  
pretējā gadījumā BĒRNS var gūt  
SMAGAS TRAUMAS vai IET BOJĀ.

**ET:** ÄRGE kasutage tahapoole  
suunatud lapseturvaistet istmel, mille  
ees on AKTIIVSE TURVAPADJAGA  
kaitstud iste, sest see võib  
põhjustada LAPSE SURMA või  
TÕSISE VIGASTUSE.

**MT:** QATT tuża trażżin għat-tfal li  
jgħares lejn in-naħa ta' wara fuq sit  
protett b'AIRBAG ATTIV quddiemu;  
dan jista' jikkawża l-MEWT jew  
ĠRIEHI SERJI lit-TFAL.

**GA:** Ná húsáid srian sábháilteachta  
linbh cúil RIAMH ar shuíochán a  
bhfuil mála aeir ag feidhmiú os a  
chomhair. Tá baol BÁIS nó GORTÚ  
DONA don PHÁISTE ag baint leis.

Beyond the warning required by  
ECE R94.02, for safety reasons a  
forward-facing child restraint system  
must only be used subject to the  
instructions and restrictions in the  
table ⇨ 50.

The airbag label is located on both  
sides of the front passenger sun visor.  
Airbag deactivation ⇨ 45.

## Front airbag system

The front airbag system consists of one airbag in the steering wheel and one in the instrument panel on the front passenger side. These can be identified by the word **AIRBAG**.

The front airbag system is triggered in the event of a front-end impact of a certain severity. The ignition must be switched on.

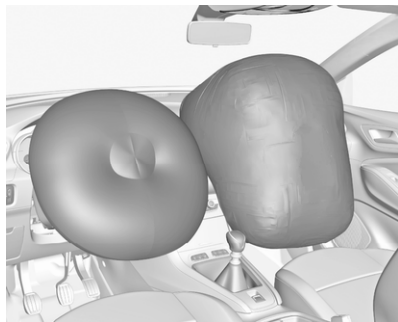

The inflated airbags cushion the impact, thereby reducing the risk of injury to the upper body and head of the front seat occupants considerably.

### ⚠ Warning

Optimum protection is only provided when the seat is in the proper position.

Seat position ⇨ 31.

Keep the area in which the airbag inflates clear of obstructions.

Fit the seat belt correctly and engage securely. Only then is the airbag able to protect.

## Side airbag system

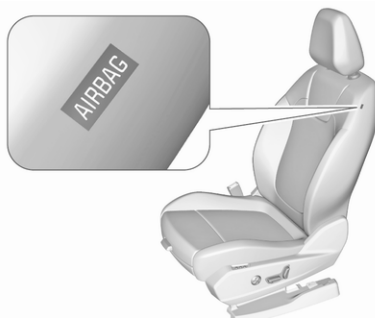

The side airbag system consists of an airbag in each front seat backrest. This can be identified by the word **AIRBAG**.

The side airbag system is triggered in the event of a side impact of a certain severity. The ignition must be switched on.



The inflated airbags cushion the impact, thereby reducing the risk of injury to the upper body and pelvis in the event of a side-on collision considerably.

### ⚠ Warning

Keep the area in which the airbag inflates clear of obstructions.

#### Notice

Only use protective seat covers that have been approved for the vehicle. Be careful not to cover the airbags.

### Curtain airbag system

The curtain airbag system consists of an airbag in the roof frame on each side. This can be identified by the word **AIRBAG** on the roof pillars.

The curtain airbag system is triggered in the event of a side-on impact of a certain severity. The ignition must be switched on.

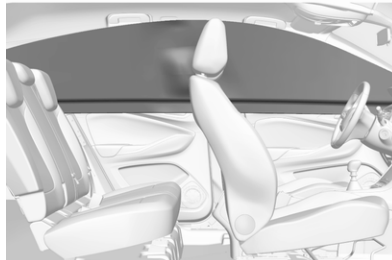

The inflated airbags cushion the impact, thereby reducing the risk of injury to the head in the event of a side-on impact considerably.

### ⚠ Warning

Keep the area in which the airbag inflates clear of obstructions.

The hooks on the handles in the roof frame are only suitable for hanging up light articles of clothing, without coat hangers. Do not keep any items in these clothes.

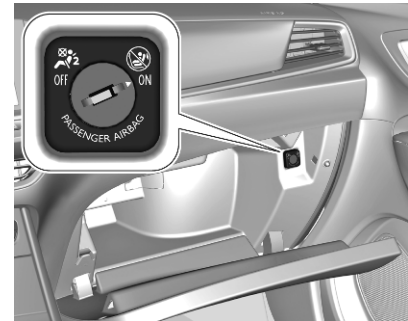

### Airbag deactivation

The front passenger airbag system must be deactivated for child restraint system on the passenger seat according to the instructions in the table ↗ 50. The side airbag and curtain airbag systems, the belt pretensioners and all driver airbag systems will remain active.



The front passenger airbag system can be deactivated via a key-operated switch in the glovebox.

Use the ignition key to choose the position:

OFF  : front passenger airbag is deactivated and will not inflate in the event of a collision, control indicator OFF  illuminates continuously in the centre console

ON  : front passenger airbag is active

### Danger

Deactivate passenger airbag only in combination with the use of a child restraint system, subject to the instructions and restrictions in the table ⇨ 50.

Otherwise, there is a risk of fatal injury for a person occupying a seat with a deactivated front passenger airbag.



If the control indicator  illuminates for approx. 60 seconds after the ignition is switched on, the front passenger airbag system will inflate in the event of a collision.

If the control indicator  illuminates after the ignition is switched on, the front passenger airbag system is deactivated. It stays on while the airbag is deactivated.

If both control indicators are illuminated at the same time, there is a system failure. The status of the system is not discernible, therefore no person is allowed to occupy the front passenger seat. Contact a workshop immediately.

Consult a workshop immediately if neither of the two control indicators are illuminated.

Change status only when the vehicle is stopped with the ignition off.

Status remains until the next change.

Control indicator for airbag deactivation ⇨ 81.



## Child restraints

### Child restraint systems

#### **⚠ Danger**

If using a rear-facing child restraint system on the front passenger seat, the airbag system for the front passenger seat must be deactivated. This also applies to certain forward-facing child restraint systems as indicated in the tables ⇨ 50.

Airbag deactivation ⇨ 45.

Airbag label ⇨ 40.

We recommend a child restraint system which is tailored specifically to the vehicle. For further information, contact your workshop.

Before fastening a child seat adjust the head restraint ⇨ 30.

When a child restraint system is being used, pay attention to the following usage and installation instructions and also those supplied with the child restraint system.

Always comply with local or national regulations. In some countries, the use of child restraint systems is forbidden on certain seats.

Child restraint systems can be fastened with:

- Three-point seat belt
- ISOFIX brackets
- Top-tether

#### **Three-point seat belt**

Child restraint systems can be fastened by using a three-point seat belt. After fastening the child restraint system the seat belt has to be tightened ⇨ 50.

#### **ISOFIX brackets**



Fasten vehicle-approved ISOFIX child restraint systems to the ISOFIX brackets. Specific vehicle ISOFIX child restraint system positions are marked in the ISOFIX table ⇨ 50.

ISOFIX brackets are indicated by a label on the backrest.

An i-Size child restraint system is an universal ISOFIX child restraint system according UN Regulation No. 129.

All i-Size child restraint systems can be used on any vehicle seat suitable for i-Size, i-Size table ⇨ 50.

Either a Top-tether strap or a support leg must be used in addition to the ISOFIX brackets.



i-Size child seats and vehicle seats with i-Size approval are marked with i-Size symbol, see illustration.

### Top-tether anchors

Top-tether anchors are marked with the symbol  for a child seat.

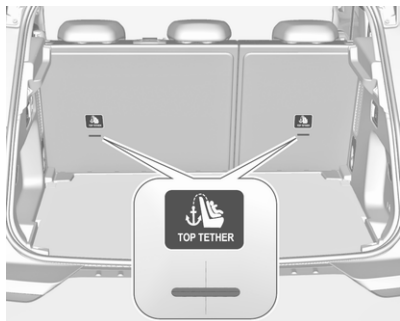

In addition to the ISOFIX brackets, fasten the Top-tether strap to the Top-tether anchors.

ISOFIX child restraint systems of universal category positions are marked in the table by IUF ⇨ 50.

### Selecting the right system

The rear seats are the most convenient location to fasten a child restraint system.

Children should travel facing rearwards in the vehicle as long as possible. This makes sure that the child's backbone, which is still very weak, is under less strain in the event of an accident.

Suitable are child restraint systems that comply with valid UN ECE regulations. Check local laws and regulations for mandatory use of child restraint systems.

The following child restraints are recommended for the following weight classes:

- **Group 0, Group 0+:** Maxi Cosi Cabriofix with or without ISOFIX base for children up to 13 kg
- **Group I:** Duo Plus with ISOFIX and Top-tether for children from 9 kg to 18 kg
- **Group II, Group III:** Kidfix XP with or without ISOFIX for children from 15 kg to 36 kg
- **Group III:** Graco Booster for children from 22 kg to 36 kg

Ensure that the child restraint system to be installed is compatible with the vehicle type.

Ensure that the mounting location of the child restraint system within the vehicle is correct, see following tables.

Allow children to enter and exit the vehicle only on the side facing away from the traffic.

When the child restraint system is not in use, secure the seat with a seat belt or remove it from the vehicle.

**Notice**

Do not affix anything on the child restraint systems and do not cover them with any other materials.

A child restraint system which has been subjected to stress in an accident must be replaced.

## Child restraint installation locations

### Permissible options for fastening a child restraint system with a three-point seat belt

Weight class	On front passenger seat		On rear outer seats	On rear centre seat
	activated airbag	deactivated airbag		
Group 0: up to 10 kg	X	U/L <sup>1,2</sup>	U/L <sup>3</sup>	U
Group 0+: up to 13 kg	X	U/L <sup>1,2</sup>	U/L <sup>3</sup>	U
Group I: 9 to 18 kg	X	U/L <sup>1,2</sup>	U/L <sup>3,4</sup>	U <sup>4</sup>
Group II: 15 to 25 kg	U/L <sup>1,2</sup>	X	U/L <sup>3,4</sup>	U <sup>4</sup>
Group III: 22 to 36 kg	U/L <sup>1,2</sup>	X	U/L <sup>3,4</sup>	U <sup>4</sup>

U : universal suitability in conjunction with three-point seat belt

L : suitable for particular child restraint systems of the 'specific-vehicle', 'restricted' or 'semi-universal' categories. The child restraint system must be approved for the specific vehicle type (refer to the vehicle type list of the child restraint system)

X : no child restraint system permitted in this weight class

<sup>1</sup> : move seat forwards as far as necessary and adjust seat backrest inclination as far as necessary to a vertical position to ensure that the belt runs forwards from the upper anchorage point

<sup>2</sup> : move seat height adjustment upwards as far as necessary and adjust seat backrest inclination as far as necessary to a vertical position to ensure that the belt is tight on the buckle side

<sup>3</sup> : move the respective front seat ahead of the child restraint system forwards as far as necessary

<sup>4</sup> : adjust the respective headrest as necessary or remove if required

## Permissible options for fitting an ISOFIX child restraint system with ISOFIX brackets

Weight class	Size class	Fixture	On front passenger seat		On rear outer seats	On rear centre seat
			activated airbag	deactivated airbag		
Group 0: up to 10 kg	G	ISO/L2	X	X	X	X
	F	ISO/L1	X	X	X	X
	E	ISO/R1	X	IL	IL <sup>3</sup>	X
Group 0+: up to 13 kg	E	ISO/R1	X	IL	IL <sup>3</sup>	X
	D	ISO/R2	X	IL	IL <sup>3</sup>	X
	C	ISO/R3	X	IL	IL <sup>3</sup>	X
Group I: 9 to 18 kg	D	ISO/R2	X	IL	IL <sup>3,4</sup>	X
	C	ISO/R3	X	IL	IL <sup>3,4</sup>	X
	B	ISO/F2	X	IL, IUF	IL, IUF <sup>3,4</sup>	X
	B1	ISO/F2X	X	IL, IUF	IL, IUF <sup>3,4</sup>	X
	A	ISO/F3	X	IL, IUF	IL, IUF <sup>3,4</sup>	X
Group II: 15 to 25 kg			X	X	IL <sup>3,4</sup>	X
Group III: 22 to 36 kg			X	X	IL <sup>3,4</sup>	X

- IL : suitable for particular ISOFIX restraint systems of the 'specific-vehicle', 'restricted' or 'semi-universal' categories. The ISOFIX restraint system must be approved for the specific vehicle type (refer to the vehicle type list of the child restraint system)
- IUF : suitable for ISOFIX forward-facing child restraint systems of universal category approved for use in this weight class
- X : no ISOFIX child restraint system approved in this weight class
- 1 : move seat forwards as far as necessary and adjust seat backrest inclination as far as necessary to a vertical position to ensure that the belt runs forwards from the upper anchorage point
- 2 : move seat height adjustment upwards as far as necessary and adjust seat backrest inclination as far as necessary to a vertical position to ensure that the belt is tight on the buckle side
- 3 : move the respective front seat ahead of the child restraint system forwards as far as necessary
- 4 : adjust the respective headrest as necessary or remove if required

#### ISOFIX size class and seat device

- A – ISO/F3 : forward-facing child restraint system for children of maximum size in the weight class 9 to 18 kg
- B – ISO/F2 : forward-facing child restraint system for smaller children in the weight class 9 to 18 kg
- B1 – ISO/F2X : forward-facing child restraint system for smaller children in the weight class 9 to 18 kg
- C – ISO/R3 : rear-facing child restraint system for children of maximum size in the weight class up to 18 kg
- D – ISO/R2 : rear-facing child restraint system for smaller children in the weight class up to 18 kg
- E – ISO/R1 : rear-facing child restraint system for young children in the weight class up to 13 kg
- F – ISO/L1 : left lateral facing position child restraint system (carry-cot)
- G – ISO/L2 : right lateral facing position child restraint system (carry-cot)

#### Permissible options for fitting an i-Size child restraint system with ISOFIX brackets

	On front passenger seat		On rear outer seats	On rear centre seat
	activated airbag	deactivated airbag		
i-Size child restraint systems	X	i - U	i - U	X

- 
- i - U : suitable for i-Size 'universal' forward and rearward facing child restraint systems
  - X : seating position not suitable for i-Size 'universal' child restraint systems.

## Storage

<b>Storage compartments</b> .....	<b>54</b>
Glovebox .....	54
Cupholders .....	54
Centre console storage .....	55
<b>Load compartment</b> .....	<b>55</b>
Load compartment cover .....	57
Rear floor storage cover .....	58
Lashing eyes .....	59
Safety net .....	59
Warning triangle .....	61
First aid kit .....	61
<b>Roof rack system</b> .....	<b>62</b>
Roof rack .....	62
<b>Loading information</b> .....	<b>62</b>

## Storage compartments

### ⚠ Warning

Do not store heavy or sharp objects in the storage compartments. Otherwise, the storage compartment lid could open and vehicle occupants could be injured by objects being thrown around in the event of hard braking, a sudden change in direction or an accident.

## Glovebox

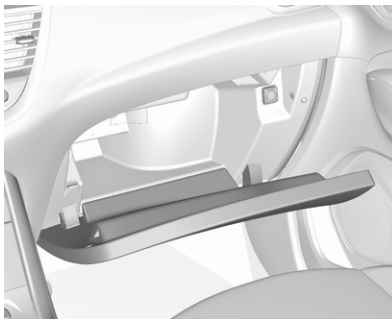

On some versions the glovebox is ventilated. Air ventilation and temperature depend on the settings of the climate control system. The air vent in the glovebox can be closed ↻ 113.

Other versions may have a CD player in the glovebox.

The glovebox should be closed whilst driving.

## Cupholders

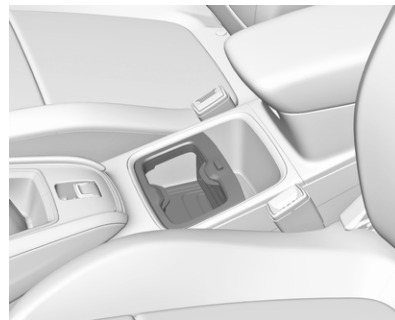

Cupholders are located in the centre console.



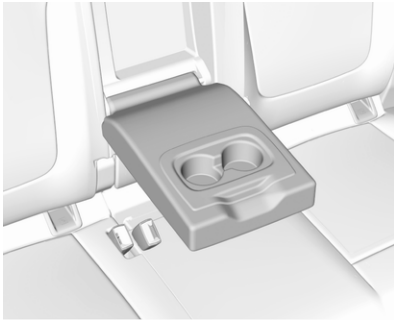

Additional cupholders are located in the rear armrest. Fold down armrest.

## Centre console storage

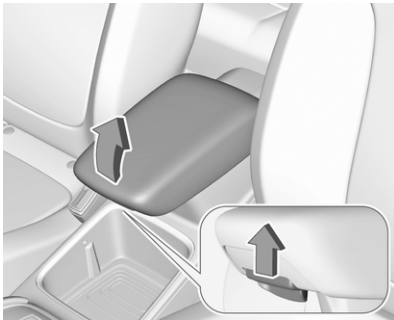

The storage container can be used to store small items.

Depending on the version, the storage compartment is located under a cover.

## Load compartment

The rear seat backrest is divided into 2/3 to 1/3 parts. Both parts can be folded down individually to increase the size of the load compartment.

Before folding rear seat backrests, execute the following if necessary:

- Move front seats forward if necessary.
- Remove the load compartment cover.
- Press and hold the catch to push the head restraints down.

Load compartment cover ⇨ 57.

Head restraints ⇨ 30

## Load compartment extension

- Check that the outer seat belts are lying correctly on the backrests.

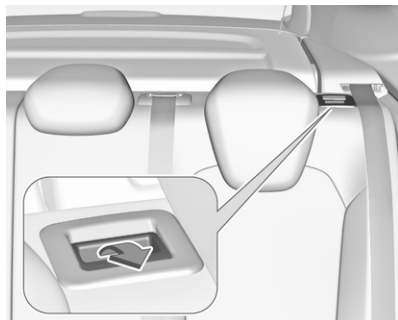

- Pull the release lever on one or both outer sides and fold down the backrests onto the seat cushion.

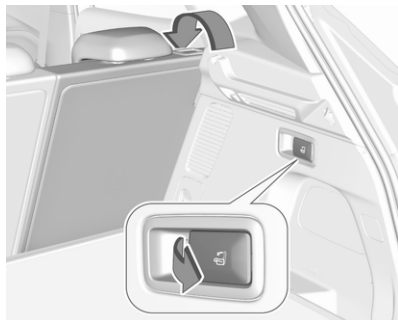

- Alternatively fold seat backrests from the load compartment: pull switch on left or right sidewall of the load compartment to fold the corresponding part of the rear seat backrest.

### **⚠ Warning**

Take care when operating the rear backrests from the load compartment. The backrest is folded with considerable power. Risk of injury, particularly to children.

Ensure that nothing is attached to the rear seats or located on the seat cushion.

- To fold up, raise the backrests and guide them into an upright position until they engage audibly.

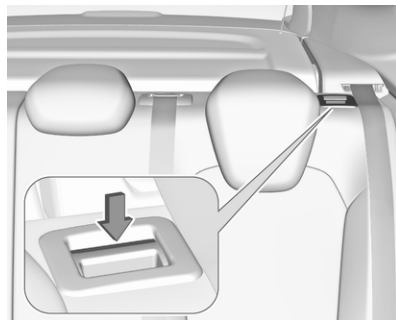

### **⚠ Warning**

When folding up, ensure that backrests are securely locked in position before driving. Failure to do so may result in personal injury or damage to the load or vehicle in the event of hard braking or a collision.

### Opening the pass through in the centre backrest



Fold down the rear armrest.



Pull grip and open the cover.

Suitable for loading long, narrow objects.

### Load compartment cover

Do not place any objects on the cover.

### Removing cover



Unhook retaining straps from tailgate.

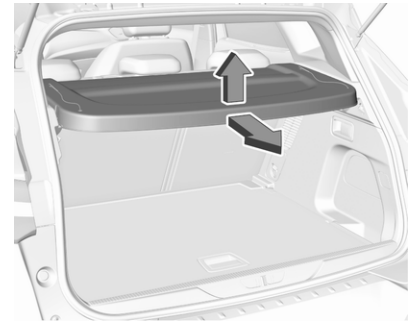

Lift cover at the rear and push it upwards at the front.

Remove the cover.

### Fitting cover

Engage cover in side guides and fold downwards. Attach the retaining straps to the tailgate.

## Rear floor storage cover

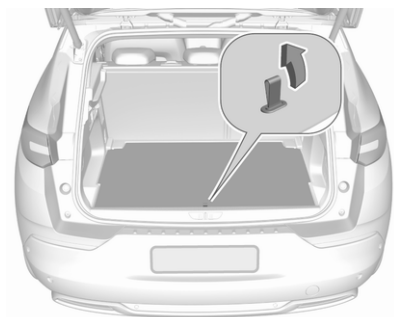

The rear floor cover can be lifted and removed. Raise cover at the loop and remove.

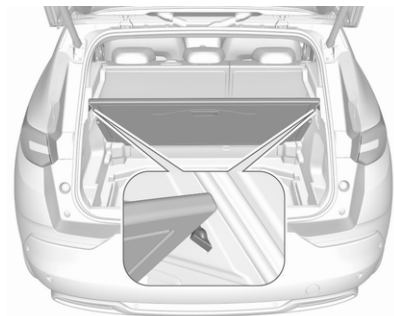

To hold the load compartment cover in an upright position, lift it up past the retractable stops.

## Double load floor

The double load floor can be inserted in the load compartment in two positions:

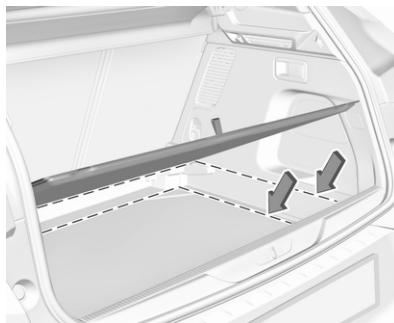

- lower position above the spare wheel well cover
- upper position interlocked with the grab handle into back panel trim

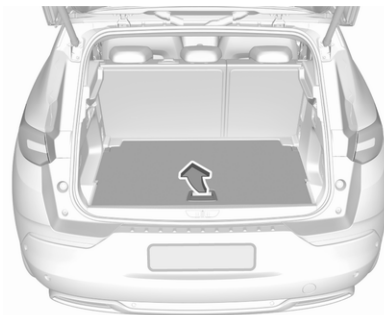

To remove, press the handle to unlock the load floor and lift it up while using the handle.

If mounted in the upper position, the space between the load floor and the spare wheel well cover can be used as a storage compartment.

In this position, if the rear seat backrests are folded forwards, an almost completely flat load bay is created.

In the upper position, the double load floor is able to withstand a maximum load of 100 kg. In the lower position, the double load floor is able to withstand the maximum load of 150 kg.

## Lashing eyes

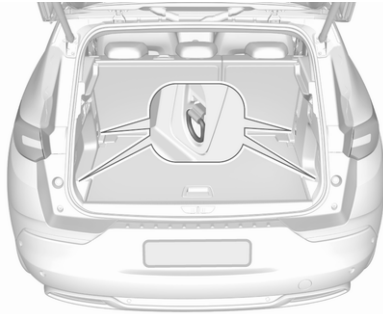

The lashing eyes are designed to secure items against slippage, e.g. using lashing straps or luggage net.

## Safety net

The safety net can be installed behind the rear seats or, if the rear seat backrests are folded, behind the front seats.

Passengers must not be transported behind the safety net.

## Installation

### Behind the rear seats



- There are installation openings on both sides in the roof frame above the rear seats: suspend and engage rod of net at one side, compress rod and suspend and engage at the other side.

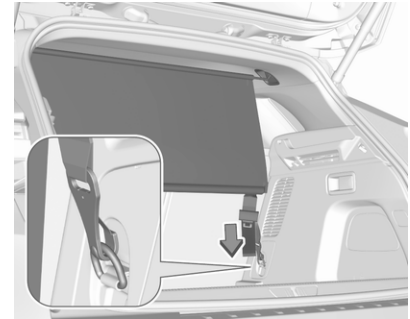

- Attach the hooks of safety net straps in the lashing eyes behind the rear seats.
- Tension both straps by pulling at the loose end.
- Rear seat backrests must be raised up.

## Behind the front seats

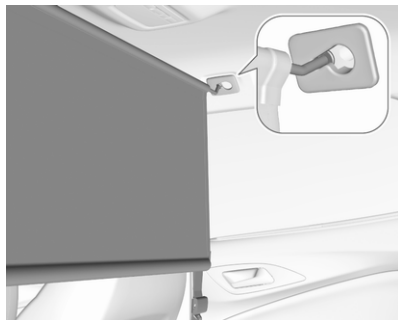

- There are installation openings on both sides in the roof frame above the front seats: suspend and engage rod of net at one side, compress rod and suspend and engage at the other side.

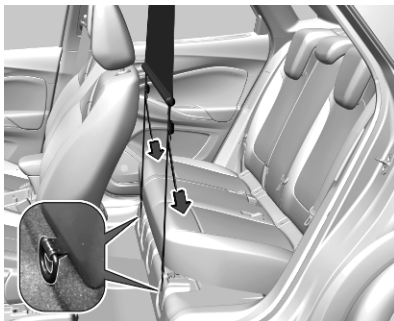

- Attach hooks of safety net straps to the lashing eyes at the lower area of the rear seats.
- Tension both straps by pulling at the loose end.
- Push down head restraints and fold down rear seat backrests ↗ 55.

Depending on version, the hooks of the safety net straps are attached to the lashing eyes on the backside of the rear seats.

- Push down head restraints and fold down rear seat backrests.

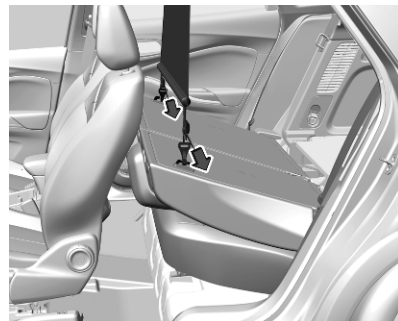

- Attach the hooks of safety net straps to the lashing eyes on the backside of the rear sets.
- Tension both straps by pulling at the loose end.

## Removal

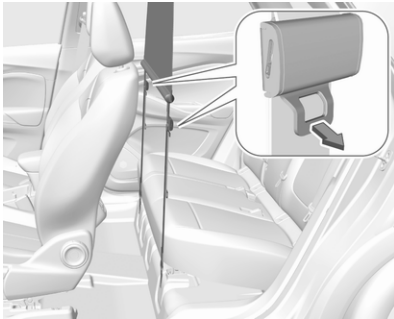

Pull the flap at the tightener on both sides to release the straps. Detach hooks from the lashing eyes.

Unhook the safety net rods from the installation openings in the roof frame.

Roll up the net and secure with a strap.

## Warning triangle



Stow the warning triangle in the space on the inside of the tailgate and secure it with the Velcro® fastener.

Depending on version, the warning triangle may be stowed below the rear floor cover of the load compartment.

## First aid kit

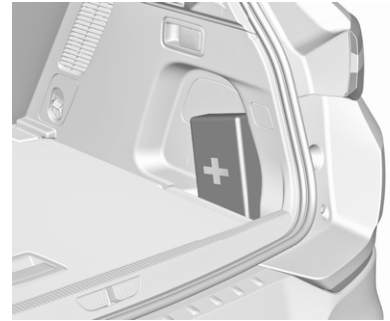

Stow the first aid kit in the storage compartment on the right side of the load compartment.

Depending on version, the first aid kit may be stowed below the rear floor cover of the load compartment.

## Roof rack system

### Roof rack

For safety reasons and to avoid damage to the roof, the vehicle-approved roof rack system is recommended.

Follow the installation instructions and remove the roof rack when not in use.

### Vehicles with roof railing

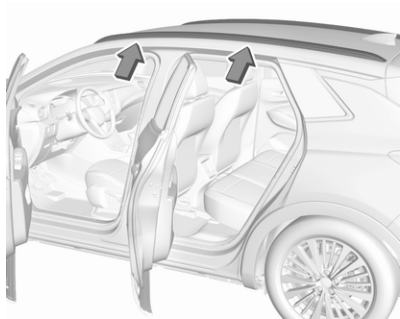

Fasten the roof rack in the roof railing above the mounting points located in each door frame of the vehicle body.

### Vehicles without roof railing

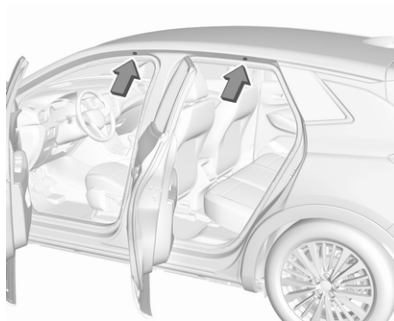

Open all doors.

Mounting points are located in each door frame of the vehicle body.

Detach the cover from each mounting point and fasten the roof rack with the attached screws.

## Loading information

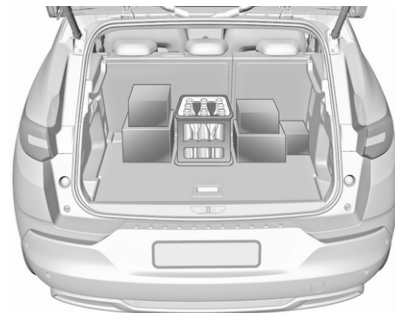

- Heavy objects in the load compartment should be placed against the seat backrests. Make sure that the backrests are securely engaged. If objects can be stacked, heavier objects should be placed at the bottom.
- Prevent sliding of loose objects by securing them with straps attached to the lashing eyes ⇨ 59.
- Do not allow the load to protrude above the upper edge of the backrests.



- Do not place any objects on the load compartment cover or the instrument panel, and do not cover the sensor on top of the instrument panel.
- The load must not obstruct the operation of the pedals, parking brake and gear selector, or hinder the freedom of movement of the driver. Do not place any unsecured objects in the interior.
- Do not drive with an open load compartment.

### Warning

Always make sure that the load in the vehicle is securely stowed. Otherwise objects can be thrown around inside the vehicle and cause personal injury or damage to the load or car.

- The payload is the difference between the permitted gross vehicle weight (see identification plate ⇨ 247) and the EC kerb weight.

To calculate the payload, enter the data for your vehicle in the weights table at the front of this manual.

The EC kerb weight includes weights for the driver (68 kg), luggage (7 kg) and all fluids (fuel tank 90% full).

Optional equipment and accessories increase the kerb weight.

- Driving with a roof load increases the sensitivity of the vehicle to cross-winds and has a detrimental effect on vehicle handling due to the vehicle's higher centre of gravity. Distribute the load evenly and secure it properly with retaining straps. Adjust the tyre pressure and vehicle speed according to the load conditions. Check and retighten the straps frequently. Do not drive faster than 75 mph. The permissible roof load is 85 kg. The roof load is the combined weight of the roof rack and the load.

# Instruments and controls

## Instrument panel overview ..... 66

### Controls ..... 68

Steering wheel adjustment ..... 68

Steering wheel controls ..... 68

Heated steering wheel ..... 68

Horn ..... 69

Pedestrian safety alert ..... 69

Windscreen wiper and washer .. 69

Rear window wiper and washer ..... 71

Outside temperature ..... 71

Clock ..... 72

Power outlets ..... 72

Inductive charging ..... 73

Cigarette lighter ..... 74

Ashtrays ..... 74

### Warning lights, gauges and indicators ..... 75

Speedometer ..... 75

Odometer ..... 75

Tachometer ..... 75

Fuel gauge ..... 76

Battery gauge ..... 76

Power indicator gauge ..... 76

Engine coolant temperature

gauge ..... 77

Engine oil level monitor ..... 77

Service display ..... 77

Control indicators ..... 78

Turn lights ..... 80

Seat belt reminder ..... 80

Airbag and belt tensioners ..... 80

Airbag deactivation ..... 81

Charging system ..... 81

Malfunction indicator light ..... 81

Service vehicle soon ..... 81

Stop engine ..... 81

System check ..... 82

Hybrid system active ..... 82

Hybrid system fault ..... 82

Brake and clutch system ..... 82

Electric parking brake ..... 82

Electric parking brake fault ..... 82

Automatic operation of electric parking brake off ..... 83

Antilock brake system (ABS) ..... 83

Gear shifting ..... 83

Lane departure warning ..... 83

Lane keep assist ..... 83

Advanced lane keep assist ..... 83

Electronic Stability Control and Traction Control system ..... 84

Electronic Stability Control and Traction Control system off ..... 84

Engine coolant temperature ..... 84

Preheating ..... 84

Exhaust filter ..... 84

AdBlue ..... 85

Deflation detection system ..... 85

Engine oil pressure ..... 85

Low fuel ..... 85

Charge cord connected ..... 85

Reduced engine power ..... 86

Autostop ..... 86

Exterior light ..... 86

Low beam ..... 86

High beam ..... 86

High beam assist ..... 86

LED headlights ..... 86

Front fog lights ..... 86

Rear fog light ..... 86

Rain sensor ..... 86

Night vision ..... 86

Pedestrian safety alert fault ..... 87

Side blind spot alert ..... 87

Active emergency braking ..... 87

Door open ..... 87

### Displays ..... 87

Driver Information Centre ..... 87

Info Display ..... 88

### Vehicle messages ..... 91

Warning chimes ..... 92

### Vehicle personalisation ..... 92

---

<b>Telematics services</b> .....	<b>93</b>
Vauxhall Connect .....	93
Emergency call .....	93
ERA GLONASS .....	94

## Instrument panel overview

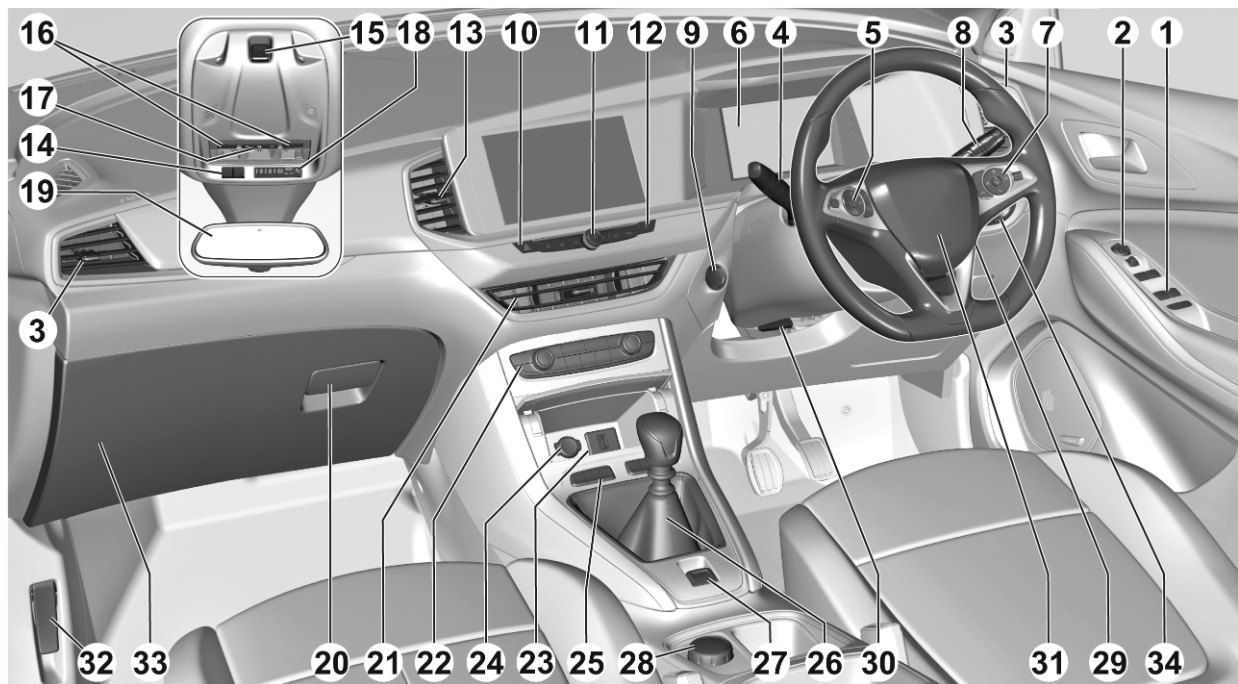

- |   |   |   |
|---|---|---|
| <p>1 Power windows ..... 25</p> <p>2 Exterior mirrors ..... 22</p> <p>3 Side air vents ..... 113</p> <p>4 Turn lights, headlight flash, low / high beam, high beam assist ..... 101</p> <p>Exit lighting ..... 105</p> <p>Parking lights ..... 102</p> <p>Buttons for Driver Information Centre ..... 87</p> <p>5 Cruise control ..... 145</p> <p>Adaptive cruise control ..... 149</p> <p>Speed limiter ..... 147</p> <p>Heated steering wheel ..... 68</p> <p>6 Instruments ..... 75</p> <p>Driver Information Centre ..... 87</p> <p>7 Infotainment controls</p> <p>8 Windscreen wiper and washer, rear wiper and washer ..... 69</p> <p>9 Power button ..... 117</p> <p>10 Central locking system ..... 9</p> | <p>11 Controls for Info Display operation ..... 88</p> <p>12 Hazard warning flashers .... 101</p> <p>13 Air vents ..... 113</p> <p>14 Vauxhall Connect ..... 93</p> <p>15 Inclination sensor ..... 20</p> <p>16 Reading lights ..... 104</p> <p>17 Interior lights ..... 103</p> <p>18 Seat belt reminder ..... 37</p> <p>Airbag deactivation ..... 45</p> <p>19 Interior mirror ..... 24</p> <p>20 Glovebox ..... 54</p> <p>21 Centre air vents ..... 113</p> <p>22 Climate control system ..... 106</p> <p>23 USB charging port ..... 72</p> <p>24 Power outlet ..... 72</p> <p>25 Parking assist, advanced parking assist ..... 160</p> <p>Lane departure warning .... 175</p> <p>Eco button for stop-start system ..... 120</p> | <p>Electronic Stability Control and Traction Control ..... 142</p> <p>Sport mode ..... 144</p> <p>26 Manual transmission ..... 135</p> <p>Automatic transmission ..... 131</p> <p>27 Electric parking brake ..... 138</p> <p>28 Selective ride control ..... 143</p> <p>29 Ignition switch ..... 116</p> <p>30 Steering wheel adjustment . . 68</p> <p>31 Horn ..... 69</p> <p>32 Bonnet release lever ..... 206</p> <p>33 Instrument panel fuse box . 218</p> <p>34 Light switch ..... 96</p> <p>Headlight range adjustment ..... 98</p> <p>Front / rear fog lights ..... 102</p> <p>Instrument illumination ..... 103</p> |
|---|---|---|

## Controls

### Steering wheel adjustment

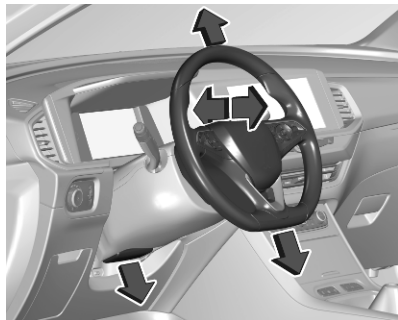

Unlock lever, adjust steering wheel, then engage lever and ensure it is fully locked.

Do not adjust steering wheel unless vehicle is stationary and steering wheel lock has been released.

### Steering wheel controls

Some driver assistance systems, Infotainment system and a connected mobile phone can be operated via the controls on the steering wheel.



Further information is available in the Infotainment manual.

Cruise control ↗ 145.

Speed limiter ↗ 147.

Adaptive cruise control ↗ 149.

### Heated steering wheel



Activate heating by pressing . Activation is indicated by the LED in the button.

Heating is operational when the engine is running and during an Autostop.

Stop-start system ↗ 120.

## Horn

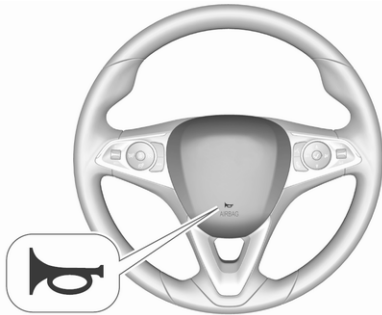

Press .

## Pedestrian safety alert

The sound of the pedestrian safety alert is generated to indicate the vehicle presence to pedestrians when combustion engine is off. It is active up to 12 mph.

## Windscreen wiper and washer

### Windscreen wiper with adjustable wiper frequency

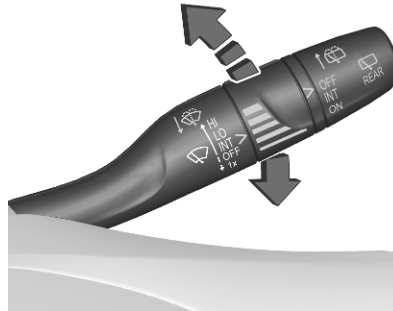

**HI** : fast  
**LO** : slow  
**INT** : interval wiping  
**OFF** : off

For a single wipe when the windscreen wiper is off, press the lever down to position **1x**.

Do not use if the windscreen is frozen.  
 Switch off in car washes.

To activate interval wiping mode the next time ignition is switched on, press the lever downwards to position **OFF** and back to **INT**.

### Adjustable wiper frequency

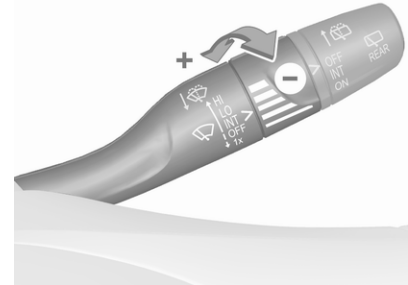

Wiper lever in position **INT**.

Turn the adjuster wheel to adjust the desired wipe frequency.

### Windscreen wiper with rain sensor

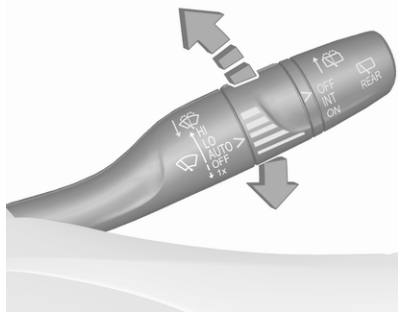

- HI** : fast  
**LO** : slow  
**AUTO** : automatic wiping with rain sensor  
**OFF** : off

In **AUTO** position, the rain sensor detects the amount of water on the windscreen and automatically regulates the frequency of the windscreen wiper. If ignition is switched off, automatic wiping mode is deactivated. To activate automatic wiping mode the next time ignition is

switched on, press the lever downwards to position **OFF** and back to **AUTO**.

For a single wipe when the windscreen wiper is off, press the lever downwards to position **1x**.

Do not use if the windscreen is frozen.  
 Switch off in car washes.

### Adjustable sensitivity of the rain sensor

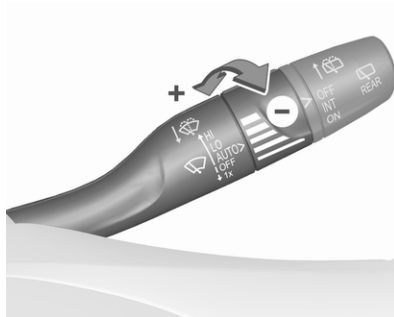

Turn the adjuster wheel to adjust the sensitivity.

Make sure the sensor is not blocked  
 ⇨ 25.

Control indicator  ⇨ 69.

### Windscreen washer

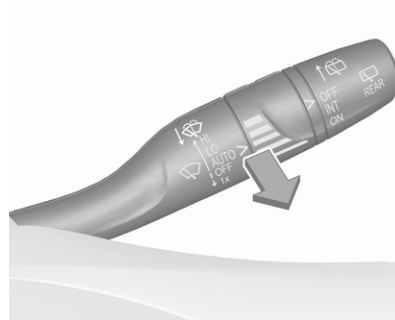

Pull lever. Washer fluid is sprayed onto the windscreen and the wiper wipes a few times.

Washer fluid ⇨ 208.



## Rear window wiper and washer

### Rear window wiper



- OFF** : off  
**INT** : intermittent operation  
**ON** : continuous operation

Do not use if the rear window is frozen.

Switch off in car washes.

The rear window wiper comes on automatically when the windscreen wiper is switched on and reverse gear is engaged.

Activation or deactivation of this function can be changed in the Info Display ↗ 88.

### Rear window washer

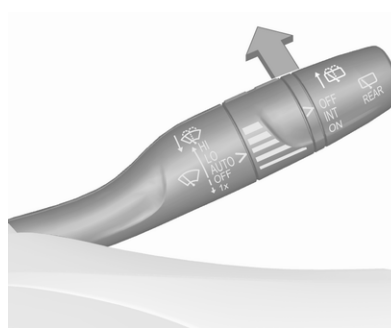

Push lever.

Washer fluid is sprayed onto the rear window and the wiper wipes a few times.

The rear window washer system is deactivated when the fluid level is low.

Washer fluid ↗ 208.

## Outside temperature

A drop in temperature is indicated immediately and a rise in temperature after a time delay.



Illustration shows an example.

If outside temperature drops to 3 °C, a warning message is displayed in the Driver Information Centre.

### **Warning**

The road surface may already be icy even though the display indicates a few degrees above 0 °C.

## Clock

Date and time are shown in the Info Display.

The adjustment of date and time is described in the Infotainment Manual.

Info Display ↪ 88.

## Power outlets

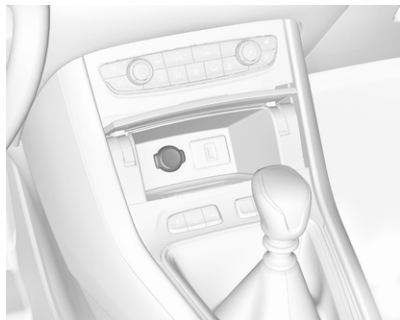

A 12 V power outlet is located behind the storage cover. Press cover to open.



A 12 V power outlets is also located in the rear console.

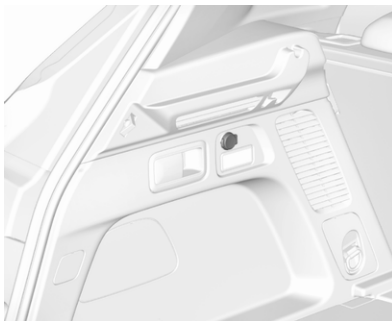

At the left sidewall in the load compartment, another 12 V power outlet is located.

Do not exceed the maximum power consumption of 120 W.

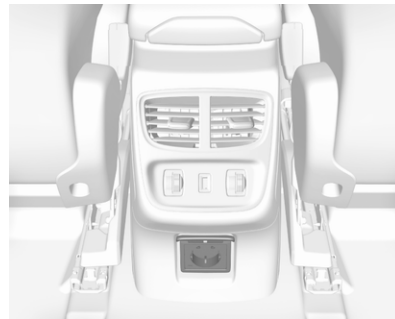

A 230 V power outlet may also be located in the rear console.

Do not exceed the maximum power consumption of 150 W.

With ignition off, the power outlets are deactivated. Additionally the power outlets are deactivated in the event of low vehicle battery voltage.

Electrical accessories that are connected must comply with the electromagnetic compatibility requirements laid down in DIN VDE 40 839.

Do not connect any current-delivering accessories, e.g. electrical charging devices or batteries.

Do not damage the outlet by using unsuitable plugs.

Stop-start system ⇨ 120.

## USB ports

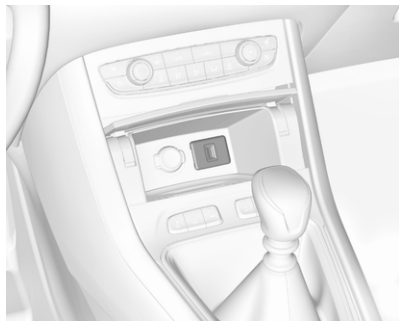

A USB port is located behind the storage cover. Press cover to open.

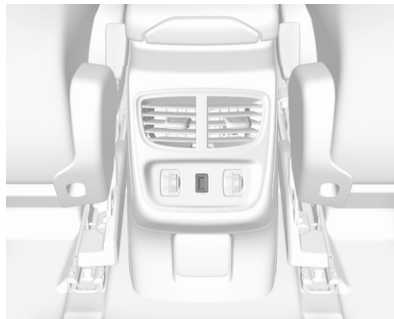

A further USB port may be located in the rear console.

The USB ports are prepared for charging external devices and provide a data connection to the Infotainment system. For further information, see Infotainment manual.

### Notice

The sockets must always be kept clean and dry.

## Inductive charging

### ⚠ Warning

Inductive charging can affect the operation of implanted pacemakers or other medical devices. If applicable, seek medical advice before using the inductive charging device.

### ⚠ Warning

Remove any metal objects from the charging device before charging a mobile device, as these objects could become very hot.

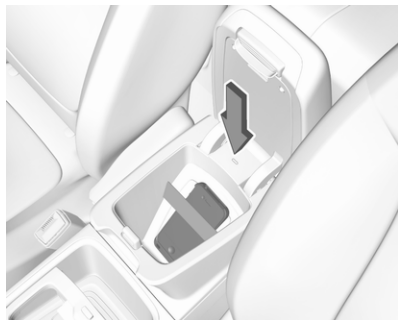

To charge a device, the ignition must be switched on.

To charge a mobile device:

1. Remove all objects from the charging device.
2. Place the mobile device with the display facing upwards on the charging device in the storage. Use the elastic band to secure the mobile device.

Charging status is indicated in the LED: illuminates green, when mobile device is charging.

PMA or Qi compatible mobile devices can be charged inductively.

On some mobile devices, a back cover with an integrated coil or a jacket may be required to use inductive charging.

Protective cover for the mobile device could have impact on the inductive charging.

In the event that the mobile device is not charging properly, rotate it 180° and place it on the charging device again.

## Cigarette lighter



The cigarette lighter is located behind the storage cover. Press cover to open.

Press in cigarette lighter. It switches off automatically once the element is glowing. Pull out cigarette lighter.

## Ashtrays

### Caution

To be used only for ash and not for combustible rubbish.



A portable ashtray can be placed in the cupholders.

## Warning lights, gauges and indicators

### Speedometer

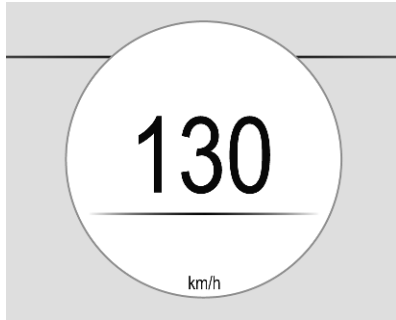

Indicates vehicle speed.

### Odometer

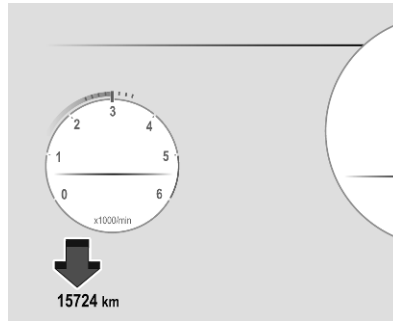

The total recorded distance is displayed in miles.

### Tachometer

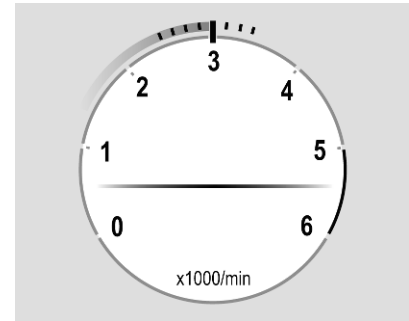

Displays the engine speed.

Drive in a low engine speed range for each gear as much as possible.

A red marker indicates the beginning of the warning zone of excessive revolutions. For Diesel engines, the warning zone starts at 5000 revolutions per minute. For petrol engines, the warning zone starts at 7000 revolutions per minute.

**Caution**

If the needle is in the red warning zone, the maximum permitted engine speed is exceeded. Engine at risk.

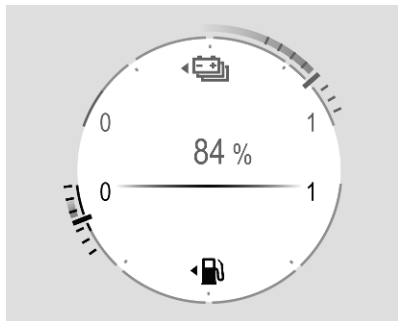
**Fuel gauge**

Control indicator  illuminates if the fuel level is low.

Never run the fuel tank dry.

The top-up quantity may be less than the specified fuel tank capacity, due to the remaining fuel in the tank.

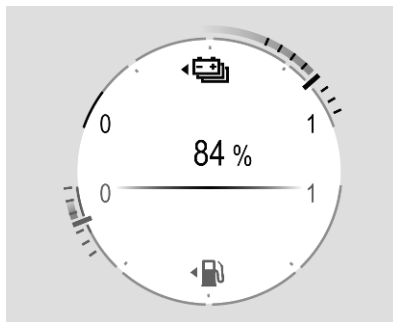
**Battery gauge**

The battery gauge displays the high voltage battery state of charge.

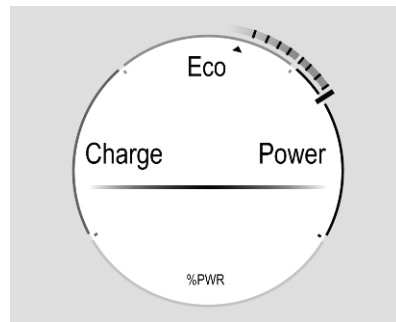
**Power indicator gauge**

The power indicator gauge informs about the current energy situation of the vehicle.

**Charge** : Battery is being charged with energy resulting from braking or deceleration of the vehicle

**Eco** : An optimum in energy is accessible in all driving modes

**Power** : Vehicle is driven in a dynamic driving style with focus on performance

## Engine coolant temperature gauge

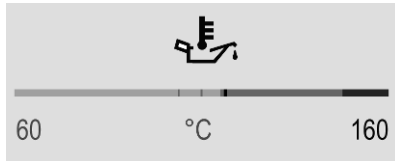

Displays the coolant temperature.

grey marking / 90 : normal operating temperature

red marking : temperature too high

Control indicator ● illuminates if coolant temperature is too high. Switch off engine immediately.



### Caution

If engine coolant temperature is too high, stop vehicle, switch off engine. Danger to engine. Check coolant level.

## Engine oil level monitor

The state of the engine oil level is displayed in the Driver Information Centre for a few seconds following the service information after switching on the ignition.

A proper state of engine oil level is indicated by a message.

If engine oil level is low,  flashes and a message is indicated, accompanied by the  indicator. Confirm engine oil level by using the dipstick and top up engine oil respectively.

Engine oil  207.

A fault of measurement is indicated by a message. Check engine oil level manually by using the dipstick.

## Service display

The service system informs when to change the engine oil and filter or a vehicle service is required. Based on driving conditions, the interval at which an engine oil and filter change is required can vary considerably.

Service information  241.

If service is required within the next 1800 miles, the remaining distance or time duration is indicated for several seconds. Simultaneously  illuminates permanently as reminder.

If service is required in less than 600 miles,  flashes and then illuminates permanently. Remaining distance or time duration is indicated for several seconds.

Overdue service is indicated by a message in the Driver Information Centre which indicates the overdue distance.  flashes and then illuminates permanently until service is executed.

## Reset of service interval

After each service, the service indicator must be reset to ensure proper functionality. It is recommended to seek the assistance of a workshop.

If service is executed by yourself, operate as following:

- switch off ignition



- press and **SET / CLR**
- switch on ignition, the distance indication begins a countdown
- when the display indicates =0, release **SET / CLR**

The symbol  disappears.

### Retrieving service information

The status of the service information can be retrieved at any time via the Info Display. Press **Check** in the vehicle settings menu. The service information is displayed for a few seconds.

Info Display ⇨ 88.

Service information ⇨ 241.

## Control indicators

The control indicators described are not present in all vehicles. The description applies to all instrument versions. Depending on the equipment, the position of the control indicators may vary. When the ignition is switched on, most control indicators will illuminate briefly as a functionality test.

The control indicator colours mean:

- red : danger, important reminder
- yellow : warning, information, fault
- green : confirmation of activation
- blue : confirmation of activation
- white : confirmation of activation
- grey : system paused, at least one system limitation has been detected







Control indicators are located in the Driver Information Centre.

Driver Information Centre ⇨ 87.



































### Overview

The numbers in the overview table indicate what to do, when a control indicator illuminates or flashes.

- 1 : only for information
- 2 : information and warning
- 3 : seek the assistance of a workshop
- 4 : stop engine and seek the assistance of a workshop
- 5 : have the cause of the fault remedied immediately by a workshop
- 6 : stop vehicle, do not continue the journey and seek the assistance of a workshop

	1	Turn lights ⇨ 80
	2	Seat belt reminder ⇨ 80
	5	Airbag and belt tensioners ⇨ 80
	1	Airbag deactivation ⇨ 81
	4	Charging system ⇨ 81
	5	Malfunction indicator light ⇨ 81



	5	Service vehicle soon ↪ 81		2 /	Electronic Stability		1	Rear fog light ↪ 86
<b>STOP</b>	6	Stop engine ↪ 81		5	Control and Traction Control system ↪ 84		1	Rain sensor ↪ 86
	4	System check ↪ 82		4	Engine coolant temper- ature high ↪ 84		1	Side blind spot alert ↪ 87
	6	Brake and clutch system ↪ 82		1	Preheating ↪ 84		2 /	Active emergency
	1 /	Electric parking brake		2 /	Exhaust filter ↪ 84	3	3	braking ↪ 87
	2 /	↪ 82, automatic		1	AdBlue ↪ 85		2	Door open ↪ 87
	5	operation of electric parking brake off ↪ 83		2 /	Deflation detection		5	Hybrid system fault ↪ 82
	5	Electric parking brake fault ↪ 82	3	3	system ↪ 85	<b>READY</b>	1	Hybrid system active ↪ 82
	2	Antilock brake system (ABS) ↪ 83		4	Engine oil pressure ↪ 85		2	Reduced engine power ↪ 86
	1	Gear shifting ↪ 83		2	Low fuel ↪ 85		3	Pedestrian safety alert fault ↪ 87
	1	Lane departure warning ↪ 83		1	Autostop ↪ 86		2	Charging cable connected ↪ 85
	2	Lane keep assist ↪ 83		1	Exterior light ↪ 86		1	Low beam ↪ 86
	2	Advanced lane keep assist ↪ 83		1	High beam ↪ 86		1	High beam assist ↪ 86
				1	Front fog lights ↪ 86		2	Electronic Stability Control and Traction Control system off ↪ 84

## Turn lights

↔ illuminates or flashes green.

### Illuminates briefly

The parking lights are switched on.

### Flashes

Turn lights or the hazard warning flashers are activated.

Rapid flashing: failure of a turn light or associated fuse, failure of turn light on trailer.

Bulb replacement ⇨ 212.

Turn lights ⇨ 101.

## Seat belt reminder

### Seat belt reminder on all seats

⚠ illuminates or flashes red in the Driver Information Centre together with the indication in the roof console for each seat belt.

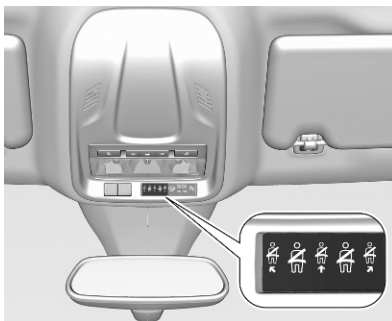

- When the ignition is switched on, ⚠ in the Driver Information Centre and the symbol for the respective seat in the roof console comes on, if the seat belt of any occupied seat has not been fastened.
- After driving off, ⚠ in the Driver Information Centre and the symbol for the respective seat in the roof console flashes for a certain time together with a chime. After a certain time of driving ⚠ illuminates constantly until the seat belt of the

respective seat has been fastened or if any passenger has unfastened the seat belt.

Seat belts ⇨ 37.

## Airbag and belt tensioners

⚠ illuminates red.

When the ignition is switched on, the control indicator illuminates for approx. 4 seconds.

If it does not illuminate, does not extinguish after 4 seconds or illuminates whilst driving, there is a fault in the airbag system. Seek the assistance of a workshop. The airbags and belt pretensioners may fail to trigger in the event of an accident.

Deployment of the belt pretensioners or airbags is indicated by continuous illumination of ⚠.

### ⚠ Warning

Have the cause of the fault remedied immediately by a workshop.

Belt pretensioners ⇨ 37.

Airbag system ⇨ 40.

## Airbag deactivation



 **ON** illuminates yellow.

The front passenger airbag is activated.

 **OFF** illuminates yellow.

The front passenger airbag is deactivated.

Airbag deactivation ⇨ 45.

## Charging system

 illuminates red.

Illuminates when the ignition is switched on and extinguishes shortly after the engine starts.

### Illuminates when the engine is running

Stop, switch off engine. Vehicle battery is not charging. Engine cooling may be interrupted. The brake servo unit may cease to be effective. Seek the assistance of a workshop.

### Malfunction indicator light

 illuminates or flashes yellow.

Illuminates when the ignition is switched on and extinguishes shortly after the engine starts.

### Illuminates when the engine is running

Fault in the emission control system. The permitted emission limits may be exceeded. Seek the assistance of a workshop immediately.

### Flashes when the engine is running

Fault that could lead to catalytic converter damage. Ease up on the accelerator until the flashing stops. Seek the assistance of a workshop immediately.

### Service vehicle soon

 illuminates yellow.

Illuminates briefly when the ignition is switched on.

May illuminate together with other control indicators and a corresponding message in the Driver Information Centre.

Seek the assistance of a workshop immediately.

### Stop engine

**STOP** illuminates red.

Illuminates briefly when the ignition is switched on.

Illuminates together with other control indicators, accompanied by a warning chime and a corresponding message in the Driver Information Centre.

Stop engine immediately and seek the assistance of a workshop.

## System check

 illuminates yellow or red.

### Illuminates yellow

A minor engine fault has been detected.

### Illuminates red

A major engine fault has been detected.

Stop engine as soon as possible and seek the assistance of a workshop.

## Hybrid system active

**READY** illuminates green. The hybrid system is active.

## Hybrid system fault

 illuminates red.

The hybrid system has a fault. Switch off ignition and seek the assistance of a workshop.

## Brake and clutch system

 illuminates red.

The brake and clutch fluid level is too low.

### Warning

Stop. Do not continue your journey. Consult a workshop.

Brake fluid ⇨ 209.

## Electric parking brake

 illuminates or flashes red.

### Illuminates

Electric parking brake is applied ⇨ 138.

### Flashes

Electric parking brake is not applied automatically. The application or the release are faulty.

### Warning

Have the cause of the fault remedied immediately by a workshop.

 illuminates yellow.

### Illuminates

Automatic operation is deactivated or faulty. Activate automatic operation again or have the cause remedied by a workshop in the event of a fault.

Automatic operation ⇨ 138.

## Electric parking brake fault

 illuminates yellow.

### Illuminates

Electric parking brake has a fault ⇨ 138.

### Warning

Have the cause of the fault remedied immediately by a workshop.

## Automatic operation of electric parking brake off

 illuminates yellow.

### Illuminates

Automatic operation is deactivated or faulty. In the event of a fault,  illuminates together with other control indicators or it is accompanied by a corresponding message in the Driver Information Centre.

Activate automatic operation again or have the cause remedied by a workshop in the event of a fault.

Automatic operation ⇨ 138.

## Antilock brake system (ABS)

 illuminates yellow.

Illuminates for a few seconds after the ignition is switched on. The system is ready for operation when the control indicator extinguishes.

If the control indicator does not extinguish after a few seconds, or if it illuminates while driving, there is a

fault in the ABS. The brake system remains operational but without ABS regulation.

Antilock brake system ⇨ 138.

## Gear shifting

▲ with the number of a higher gear is indicated, when upshifting is recommended for fuel saving reasons.

## Lane departure warning

 illuminates green or flashes yellow.

### Illuminates green

System is switched on and ready to operate.

### Flashes yellow

System recognises an unintended lane change.

Lane departure warning ⇨ 175.

## Lane keep assist

 illuminates or flashes yellow.

### Illuminates yellow

Together with  when a fault has been detected.

### Flashes yellow

The system performs a correction.

Lane keep assist ⇨ 177.

## Advanced lane keep assist

 illuminates grey, green or yellow.

### Illuminates grey

The system is paused. At least one system limitation has been detected.

### Illuminates green

The system is active and ready to operate.

### Illuminates yellow

The system has a fault.

Advanced lane keep assist ⇨ 179.

## Electronic Stability Control and Traction Control system

 illuminates or flashes yellow.

### Illuminates

A fault in the system is present. Continued driving is possible. Driving stability, however, may deteriorate depending on road surface conditions.

Have the cause of the fault remedied by a workshop.

### Flashes

The system is actively engaged. Engine output may be reduced and the vehicle may be braked automatically to a small degree.

Electronic Stability Control and Traction Control system ⇨ 142.

Selective ride control ⇨ 143.

## Electronic Stability Control and Traction Control system off

 illuminates yellow. The system has been deactivated.

Electronic Stability Control and Traction Control system ⇨ 142.

Selective ride control ⇨ 143.

## Engine coolant temperature

 illuminates red.

### Illuminates when the engine is running

Stop, switch off engine.

<b>Caution</b>
Coolant temperature too high.

Check coolant level immediately ⇨ 208.

If there is sufficient coolant, consult a workshop.

## Preheating

 illuminates yellow.

Preheating of diesel engine is activated. Only activates when outside temperature is low. Start the engine when control indicator extinguishes.

Starting the engine ⇨ 118.

## Exhaust filter

 or  illuminates yellow.

The exhaust filter requires cleaning.

Continue driving until the control indicator extinguishes.

### Illuminates temporarily

Start of saturation of the exhaust filter. Start cleaning process as soon as possible by driving at a vehicle speed of at least 40 mph.

### Illuminates constantly

Indication of a low additive level. Seek the assistance of a workshop.

Exhaust filter ⇨ 123.

## AdBlue

 flashes or illuminates yellow.

### Illuminates yellow

The remaining driving range is between 370 miles and 1500 miles.

### Flashes yellow

The remaining driving range is between 0 and 370 miles.

AdBlue level is low. Refill AdBlue soon to avoid prevention of the engine start. Up to 10 l of AdBlue can be added.

AdBlue ⇨ 124.

## Deflation detection system

 illuminates or flashes yellow.

### Illuminates

Tyre pressure loss in one or more wheels. Stop immediately and check tyre pressure.

### Flashes

Fault in system. Consult a workshop.

Deflation detection system ⇨ 223.

## Engine oil pressure

 illuminates red.

Illuminates when the ignition is switched on and extinguishes shortly after the engine starts.

### Illuminates when the engine is running

#### Caution

Engine lubrication may be interrupted. This may result in damage to the engine and / or locking of the drive wheels.

1. Select neutral gear.
2. Move out of the flow of traffic as quickly as possible without impeding other vehicles.
3. Switch off ignition.

#### Warning

When the engine is off, considerably more force is needed to brake and steer. During an Autostop the brake servo unit will still be operational.

Do not remove key until vehicle is stationary, otherwise the steering wheel lock could engage unexpectedly.

Keep engine turned off and let the vehicle be towed to a workshop.

## Low fuel

● illuminates yellow.

Level in fuel tank is too low.

Refuelling ⇨ 193.

Bleeding the diesel fuel system ⇨ 211.

## Charge cord connected

 illuminates red.

The vehicle plug of the charge cord is still connected to the charge port. The vehicle cannot be started.

Disconnect the vehicle plug from the charge port and close the charge port door.

Charging ⇨ 187.

## Reduced engine power

 illuminates yellow.

The charging level of the high voltage battery is low. Only reduced engine power is available.

## Autostop

 illuminates or flashes green.

## Illuminates green

Engine is in an Autostop.

## Flashes green

Autostop is temporarily unavailable, or Autostop mode is invoked automatically.

Stop-start system ⇨ 120.

## Exterior light

 illuminates green.

The exterior lights are on ⇨ 96.

## Low beam

 illuminates green.

Illuminated when low beam is on.

## High beam

 illuminates blue.

Illuminates when high beam is on, during headlight flash ⇨ 97.

## High beam assist

 illuminates green.

The high beam assist is activated ⇨ 97.

## LED headlights

 illuminates and a warning message is displayed in the Driver Information Centre.

Seek the assistance of a workshop.

## Front fog lights

 illuminates green.

The front fog lights are on ⇨ 102.

## Rear fog light

 illuminates yellow.

The rear fog light is on ⇨ 102.

## Rain sensor

 illuminates green.

Illuminated when rain sensor position on wiper lever is selected.

Windscreen wiper and washer ⇨ 69.

## Night vision

 illuminates green or red.

If the conditions are met to display the image provided by the night vision camera and to trigger alerts,  illuminates green.

If some operation conditions are not met and only the image provided by the night vision camera is available,  illuminates orange.



 illuminates accompanied by an additional message to indicate a malfunction of the system.

## Pedestrian safety alert fault

 illuminates yellow.

The pedestrian safety alert is not working.

## Side blind spot alert

 illuminates green.

The system is active ⇨ 168.

## Active emergency braking

 illuminates or flashes yellow.

### Illuminates

The system has been deactivated or a fault has been detected.

Additionally, a warning message is displayed in the Driver Information Centre.

Check the reason of the deactivation ⇨ 157 and in case of a system fault, seek the assistance of a workshop.

### Notice

 also illuminates if the seat belts of the front passengers are not fastened. In this case, active emergency braking is deactivated.

### Flashes

The system is actively engaged.

Depending on the situation, the vehicle may automatically brake moderately or hard.

Forward collision alert ⇨ 155.

Front pedestrian protection ⇨ 159.

### Door open

 illuminates red.

A door or the tailgate is open.

## Displays

### Driver Information Centre

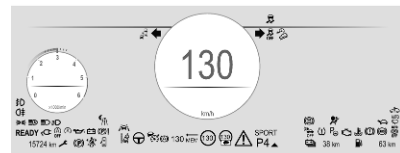

In addition to warning lights, gauges and indicators, the following information is available:

- overall and trip odometer
- digital speed indication
- trip / fuel information menu
- gear shift indication
- service information
- vehicle and warning messages
- driver assistance messages
- pop-up messages
- AdBlue information
- powerflow
- range autonomy

## Selecting menus and functions

The menus and functions can be selected via the buttons on the indicator lever.

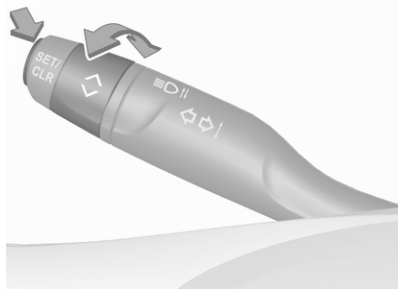

Turn the adjuster wheel to select a page in the trip / fuel information menu.

Press **SET / CLR** to confirm or reset a function.

Vehicle and service messages are popped up in the Driver Information Centre if required. Scroll messages by turning the adjuster wheel. Confirm messages by pressing **SET / CLR**.

Vehicle messages ↗ 91.

## Personalised view

Personalised views can be selected by turning the adjuster wheel.

The personalised views can be adjusted in the settings menu in the Info Display.

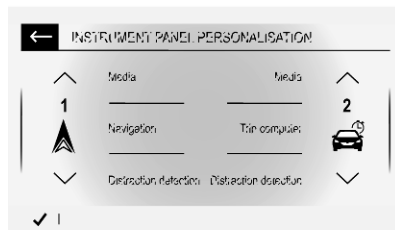

Choose the content, e.g. the navigation map or current trip information, and confirm the settings.

## Info Display



The illustrations show different variants of the infotainment system.



The Info Display can indicate:

- time ↻ 72
- outside temperature ↻ 71
- date ↻ 72
- Infotainment system, see description in the Infotainment manual
- indication of rear view camera ↻ 174
- indication of panoramic view system ↻ 171
- indication of parking assist instructions ↻ 160
- navigation, see description in the Infotainment manual
- vehicle and system messages ↻ 91
- settings for vehicle personalisation ↻ 92
- indication of the current powerflow within the hybrid system
- indication of the average fuel and power consumption

- settings for programmable charging ↻ 190
- settings for eSave function

### Selecting menus and settings

There are three options to operate the display:

- via buttons next to the display
- by touching the touchscreen with the finger
- via speech recognition

### Button and touch operation



Press  to switch on the display.

Press  to select system settings (units, language, time and date).

Press  to select vehicle settings or driving functions.

Touch required menu display icon or a function with the finger.

Confirm a required function or selection by touching.

Touch  or  on the display to exit a menu without changing a setting.

For further information, see Infotainment Manual.

### Speech recognition

Description see Infotainment Manual.

### Powerflow

This menu displays the current energy flow within the hybrid system. The components will be highlighted when they are active.



1. Press .
2. Select **Flow**.

Different colours show which engine is used and whether energy is regenerated.

- green: electric engine operating
- orange: combustion engine operating
- blue: regenerating energy

### Average consumption

This menu displays the average power and fuel consumption during the current trip. The current trip is subdivided into time steps. For each time step, the average consumption is displayed. The time steps can be modified.

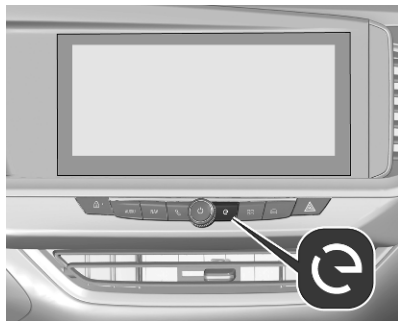

1. Press .
2. Select **Statistics**.
3. Press **+** and **-** to modify the time steps.

### Power consumption

The consumption of electrical power is displayed in kWh/100 miles.

- The green bars show the electric energy consumed from the battery.
- The blue bars show the electric energy generated from the braking and deceleration phases of the vehicle. This energy is partially used to recharge the battery.

### Fuel consumption

The orange bars show the average fuel consumption in litre per 100 miles.

### eSave function

This function allows to provide electrical energy of the high voltage battery for a later use, e.g. for driving in areas restricted to electrical

vehicles. It is possible to reserve the complete electrical energy of the battery or a part of it.

### Notice

If the energy requested exceeds the energy of the high voltage battery, the combustion engine charges the battery. This results in a loss of performance and a higher fuel consumption.

The function can be activated in the Info Display.



1. Press .
2. Select **eSave**.

3. Select the distance for which electrical is to be reserved or reserve the whole capacity of the high voltage battery.
4. Press ON.



5. To use the reserved electrical energy change to electric mode.

The setting of this function is not stored when the ignition is switched off.

### Smartphone app

With the myVauxhall smartphone app, some vehicle functions can be operated / displayed.

To operate these functions, download the app from Apple App Store or Google Play Store.

## Vehicle messages

Messages are indicated in the Driver Information Centre, in some cases together with a warning chime.

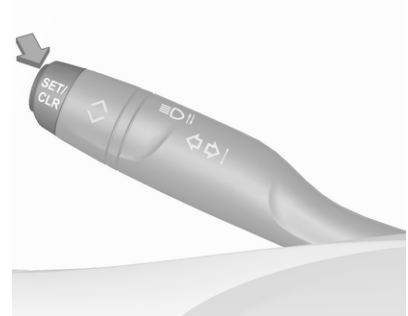

Press **SET / CLR** to confirm a message.

### Vehicle and service messages

The vehicle messages are displayed as text. Follow the instructions given in the messages.

## Messages in the Info Display

Some important messages may appear additionally in the Info Display. Some messages only pop-up for a few seconds.

## Warning chimes

The warning chime regarding not fastened seat belts has priority over any other warning chime.

## When starting the engine or whilst driving

A warning chime will sound when

- a seat belt is not fastened
- a door or the tailgate is not fully closed
- a certain speed is exceeded with parking brake applied
- cruise control deactivates automatically
- a programmed speed or speed limit is exceeded
- a warning message appears in the Driver Information Centre

- the electronic key is not in the passenger compartment
- the parking assist detects an object
- an unintended lane change occurs
- the exhaust filter has reached the maximum filling level

If several warnings appear at the same time, only one warning chime will sound

## When the vehicle is parked and / or the driver's door is opened

- With exterior lights on.

## During an Autostop

- If the driver's door is opened.
- If any condition for a restart of the engine is not fulfilled.

## Vehicle personalisation

The vehicle's behaviour can be personalised by changing the settings in the Info Display.

Some functions are only displayed or active when the engine is running.

## Multimedia



Touch  to display the vehicle personalisation menu.

Parking, lighting, comfort and safety settings are adjustable.

## Multimedia Navi Pro



Touch  to display the vehicle personalisation menu.

Parking, lighting, comfort and safety settings are adjustable.

## Telematics services

### Vauxhall Connect

Vauxhall Connect comprises multiple connected services accessible via app, online or within the vehicle.

#### Notice

Full functionality of Vauxhall Connect is subject to registration and proper activation.

Connected services may include live navigation such as online traffic information and vehicle status and information such as maintenance alerts.

Services accessible within the vehicle also include emergency call and breakdown call. These functions are automatically activated. Terms and conditions apply.

Emergency call  93.

### Breakdown call

Pressing the  button in the overhead console for more than 2 seconds connects to a roadside assistance service provider.

For information about coverage and scope of services of the roadside assistance, please refer to the Service and warranty booklet.

### Privacy settings

Privacy settings of Vauxhall Connect can be configured. This will impact the set of data being sent, e.g., in case a breakdown call is triggered. The emergency call function will not be impacted.

Depending on version, the privacy settings can be changed by simultaneously pressing  and **SOS** in the overhead console or via the system settings menu in the Info Display.

### Emergency call

#### Notice

In order to be available and operational, the system requires functioning vehicle electrics, mobile service and GPS or GLONASS satellite link. Depending on equipment, a backup battery is used.

**Notice**

The service is only available for markets where it is legally required. Furthermore, it depends on the availability of the emergency centres and the infrastructure in the country.

**Status LED in the overhead console**

Illuminates green and red and extinguishes after a short time, when the ignition is switched on: the system works properly.

Illuminates red: fault in the system. Contact a workshop.

Flashes red: backup battery needs replacement. Contact a workshop.

**Emergency call**

The emergency call function will establish a connection to the nearest public safety answering point (PSAP). A minimum set of data including vehicle and location information will be sent to the PSAP.

In case of an emergency, press the red **SOS** button in the overhead console for more than 2 seconds. The LED flashes green to confirm that a

connection to the nearest PSAP is being established. The LED illuminates steadily as long as the call is active.

Pressing the **SOS** button immediately a second time will terminate the call. The LED switches off.

**Automatic crash notification**

In case of an accident with airbag deployment and without damage of needed hardware, an automatic emergency call is established and an automatic crash notification will be transmitted to the next PSAP.

**ERA GLONASS**

ERA GLONASS is a manually or automatically actuated emergency service. Emergency centres provide assistance and information during an emergency.

In case of an accident with an impact of appropriate severity, an emergency call is placed automatically, regardless of airbag activation. An immediate connection

with an advisor will be established who will check whether help is needed.

**⚠ Danger**

The service is only available for markets where it is legally required and activated. Furthermore, the manual and the automatic emergency call function depend on the availability of the emergency centres and the infrastructure in the country.

**Notice**

In order to be available and operational, the system requires functioning vehicle electrics, mobile service and GLONASS satellite link. Depending on equipment, a backup battery is used.



## Control buttons



### SOS button

In an emergency situation press and hold SOS button for more than 2 seconds. The green LED and the voice message will confirm that the call has been sent to the emergency centre.

The green LED illuminates when the service connection is established. It will go out when the connection is complete.

A minimum set of data is transferred to the emergency centre, including such data as car location, car model, vehicle identification number. The operator will contact you and, if necessary, send rescue workers from the relevant support services.

To cancel the call, press the SOS button again. The green LED goes out. The voice message confirms the cancellation.

### Status LED

The system provides feedback via voice messages and an LED.

- Green : The system is activated. A connection to an operator is on duty.
- Red : The system is booting up after switching on ignition, the LED goes out after 3 seconds. If the LED stays red, a malfunction has been detected in the system. An emergency call may not work. Contact a workshop immediately.
- Red flashing : The internal backup battery is defective. Contact a workshop immediately.

Seek the assistance of a workshop if the LED does not illuminate after switching on the ignition.

## Lighting

<b>Exterior lighting</b> .....	<b>96</b>
Light switch .....	96
Automatic light control .....	97
High beam .....	97
High beam assist .....	97
Headlight flash .....	98
Headlight range adjustment .....	98
Headlights when driving abroad .....	99
Daytime running lights .....	99
Matrix-LED headlights .....	99
Hazard warning flashers .....	101
Turn lights .....	101
Front fog lights .....	102
Rear fog light .....	102
Parking lights .....	102
Reversing lights .....	103
Misted light covers .....	103
<b>Interior lighting</b> .....	<b>103</b>
Instrument panel illumination control .....	103
Interior lights .....	103
Reading lights .....	104
Sunvisor lights .....	104

<b>Lighting features</b> .....	<b>104</b>
Centre console lighting .....	104
Entry lighting .....	104
Exit lighting .....	105
Battery discharge protection ....	105

## Exterior lighting

### Light switch



Turn light switch:

- AUTO** : automatic light control  
switches automatically  
between daytime running  
light and headlight
- ☞☞ : sidelights
- ☞☞☞ : headlights

Control indicator ☞☞ ☞ 86.

## Tail lights

Tail lights are illuminated together with low / high beam, daytime running lights and sidelights.

## Automatic light control



When the automatic light control function is switched on and the engine is running, the system switches between daytime running lights and headlights automatically depending on the external lighting conditions and information given by the wiper system.

Make sure the sensor is not blocked  
↪ 25.

Daytime running light ↪ 99.

## Automatic headlight activation

During poor lighting conditions the headlights are switched on.

Additionally, headlights are switched on if the windscreen wipers have been activated for several wipes.

## Tunnel detection

When a tunnel is entered, headlights are switched on immediately.

## High beam

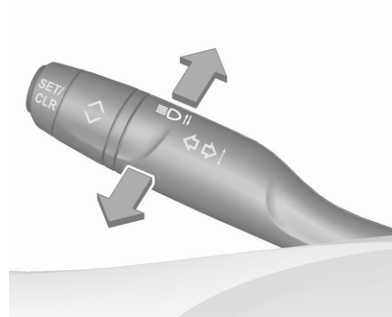

Push to switch from low to high beam.

Pull to deactivate high beam.

High beam assist ↪ 97.

## High beam assist

Once activated, the high beam assist switches high beam automatically on and off depending on vehicle speed and detected objects by the camera in the windscreen. This provides the best light distribution to the driver in each situation while avoiding dazzling other road users.

In the following cases, high beam is deactivated:

- driving in urban areas
- snowy or foggy weather conditions
- rear fog light switched on

If no restrictions are detected, the system switches back to high beam.

Glare-free high beam for Matrix-LED headlights ↪ 99.



## Activation



High beam assist is activated in the Info Display and by switching on the automatic light control.

Automatic light control ⇨ 97.

Info Display ⇨ 88.

High beam is switched on automatically in dark surroundings at a speed above 15 mph. High beam is switched off at a speed below 9 mph, but the high beam assist remains active.

The green control indicator  illuminates continuously when the high beam assist is activated, the blue  illuminates when high beam is on.

Control indicator  ⇨ 86,  ⇨ 86.

## Deactivation

Deactivate the high beam assist by switching off the automatic light control or deactivating the feature in the Info Display.

When the indicator lever is pushed while being in high beam mode, the high beam assist is temporarily deactivated.

## Headlight flash

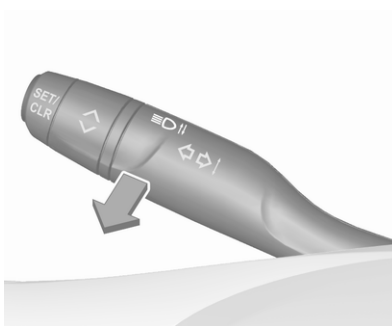

Pull to activate the headlight flash.

## Headlight range adjustment



To adapt headlight range to the vehicle load to prevent dazzling, turn thumb wheel  to required position.

### Non-electric vehicle

- 0 : front seats occupied
- 1 : all seats occupied
- 2 : driver's seat occupied and load compartment laden

### Electric vehicle

- 0 : seats occupied
- 1 : load compartment laden

Matrix-LED headlights are adjusted automatically.

## Headlights when driving abroad

### No matrix-LED headlights

When driving in countries where traffic drives on the opposite side of the road, the headlights do not have to be adjusted.

### Matrix-LED headlights

When driving in countries where traffic drives on the opposite side of the road, the headlights have to be adjusted.

1. With the engine switched off, pull the indicator lever and hold.
2. Start the engine.
3. Hold the indicator lever for another 5 seconds.
4. Release the indicator lever.

After the setting has been changed, an animation is displayed in the Driver Information Centre to indicate the change of the light distribution.

If the headlights are adjusted, a message is displayed in the Driver Information Centre each time the engine is started.

The adjustment of the headlights is kept until it is reversed by the driver. To reverse the adjustment, repeat the steps described above.

## Daytime running lights

Daytime running lights increase visibility of the vehicle during daylight.

They are switched on automatically when the engine is running and the light switch is set to **AUTO**.

The system switches between daytime running lights and low beam automatically, depending on the lighting conditions.

## Matrix-LED headlights

The Matrix-LED headlight system contains a variety of particular LEDs in each headlight which enables the control of the adaptive forward lighting functions.

Light distribution and intensity of light are variably triggered depending on the lighting conditions, road type and driving situation. The vehicle adapts

the headlights automatically to the situation to enable optimal light performance for the driver.

The adaptive forward lighting and the Matrix-LED headlights functions can be deactivated or activated in the Info Display and by switching off or on the automatic light control.

Info Display ⇨ 88.

The following functions are available if the adaptive forward lighting is activated in the Info Display and the light switch is in **AUTO** or **D**.

## Town light



Activated automatically at a speed up to approx. 31 mph. The beam has a broad shape to avoid glaring oncoming traffic.

### Country light

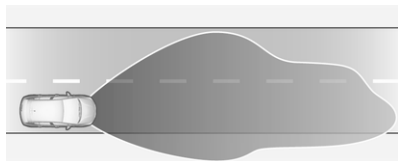

Activated automatically at a speed above 30 mph when driving in rural areas. The illumination of the current lane and the side of the road is adapted. Oncoming and preceding vehicles are not dazzled.

### Adverse weather light

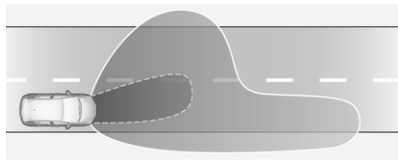

If bad weather conditions are detected, low beam is dimmed to avoid dazzling the oncoming traffic.

### Cornering light

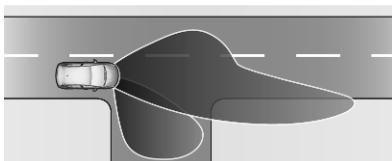

Activated at a speed of up to approx. 25 mph when turning off. Depending on the steering wheel angle and the turn lights, a particular LED light function is triggered which illuminates the direction of travel.

### Curve light

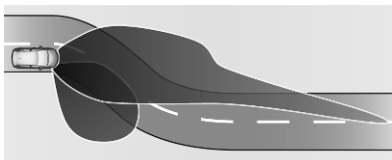

Particular LEDs, based on steering angle and speed, are additionally triggered to improve lighting in curves. This function is activated at a speed up to approx. 43 mph.

### Reverse parking function

To assist driver's orientation when parking, cornering lights and reversing light illuminate when headlights are activated and reverse gear is engaged. Cornering light and reversing light remain illuminated for a short time after disengaging the reverse gear, or when accelerating to a speed above approx. 6 mph.

### Glare-free high beam

This feature allows high to function as main driving light in dark surroundings.



Each LED on right or left side is triggered or faded out particularly according to the traffic situation. This gives the best light distribution without dazzling other road users.

Glare-free high beam is switched on automatically at a speed above 28 mph. It is switched off at a speed below 22 mph, but the system remains active.

### Motorway mode

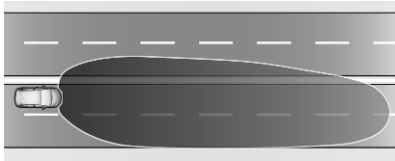

Activated automatically at a speed above 65 mph. Illumination is adapted to the higher speed driven on motorways. If there is no oncoming traffic, the visibility on the side of the vehicle is increased. When following vehicles ahead or passing, dazzling for these vehicles is reduced.

### Fault

When the system detects a failure in the matrix-LED headlight system, it selects a preset position to avoid dazzling of oncoming traffic. A warning is displayed in the Driver Information Centre.

## Hazard warning flashers



Operated by pressing .

When braking in an emergency, the hazard warning flashers are switched on automatically depending on the force of deceleration. They are switched off automatically the first time you accelerate.

## Turn lights

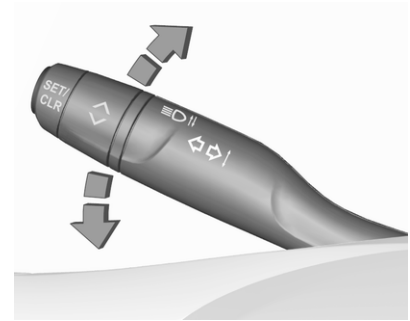

up : right turn lights  
down : left turn lights

A resistance point can be felt when moving the indicator lever.

Constant flashing is activated when the indicator lever is being moved beyond the resistance point. It is deactivated when the steering wheel is moved in the opposite direction or indicator lever is manually moved back to its neutral position.

Activate temporary flashing by holding the indicator lever just before the resistance point. Turn lights will flash until indicator lever is being released.

To activate three flashes, tap the indicator lever briefly without passing the resistance point.

If you forget to cancel the turn lights for more than 20 seconds, the volume of the audible signal will increase if the speed is above 40 mph.

## Front fog lights



Operated by pressing **D**.

Light switch in position **AUTO**: switching on front fog lights will switch headlights on automatically.

## Rear fog light



Operated by pressing **D**.

Light switch in position **AUTO**: switching on rear fog light will switch headlights on automatically.

Light switch in position **D**: rear fog light can only be switched on with front fog lights.

The vehicle rear fog light is deactivated when towing a trailer or a plug is connected with the socket, e.g. when a bicycle carrier is used.

## Parking lights

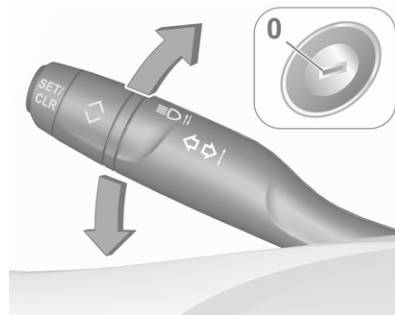

When the vehicle is parked, the parking lights on one side can be activated:

1. Switch off ignition.
2. Move the lever all the way up (right parking lights) or down (left parking lights).

Confirmed by a signal and the corresponding turn lights control indicator.



## Reversing lights

The reversing light comes on when the ignition is on and reverse gear is selected.

## Misted light covers

The inside of the light housing may mist up briefly in poor, wet and cold weather conditions, in heavy rain or after washing. The mist disappears quickly by itself. To help, switch on the headlights.

## Interior lighting

### Instrument panel illumination control



Brightness of the following lights can be adjusted when the exterior lights are on:

- instrument panel illumination
- Info Display
- illuminated switches and operation elements

Turn thumb wheel  and hold until the desired brightness is obtained.

## Interior lights

During entry and exit of the vehicle, the front and rear courtesy lights automatically switch on and then off after a delay.

### Notice

In the event of an accident with airbag deployment the courtesy lights are turned on automatically.

### Front courtesy light

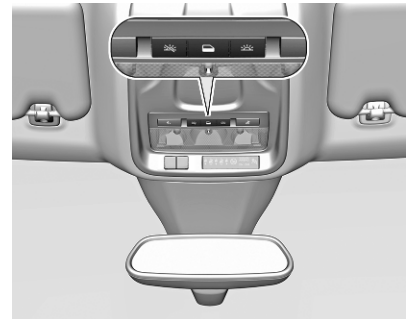

 : automatic switching on and off

press  : on

press  : off

### Rear courtesy lights

Illuminate in conjunction with the front courtesy light.

### Reading lights



Operated by pressing ☀ and ☀ in the courtesy lights.

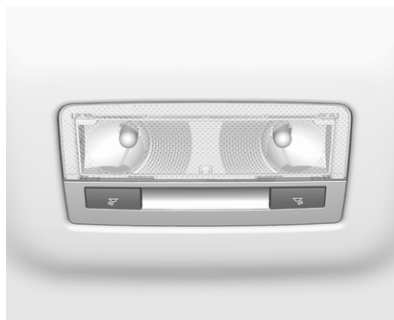

Illustration shows rear courtesy lights.

### Sunvisor lights

Illuminates when the cover is opened.

## Lighting features

### Centre console lighting

A spotlight integrated in the overhead console illuminates the centre console when headlights are switched on.

### Entry lighting

#### Welcome lighting

Some or all of the following lights are switched on for a short time by unlocking the vehicle with the radio remote control:

- headlights
- interior lights
- rear lights

The number of activated lights depends on the surrounding light conditions.

The lighting switches off immediately when the ignition is switched on.

In the case of Matrix-LED headlights, an animation is displayed.

Starting off ☞ 116.

This function can be activated or deactivated in the vehicle personalisation.

Vehicle personalisation ⇨ 92.

The following lights will additionally switch on when the driver's door is opened:

- illumination of some switches
- Driver Information Centre
- door pocket lights

## Exit lighting

The following lights are switched on when the ignition is switched off:

- headlights
- interior lights
- centre console lighting
- rear lights

They will switch off automatically after a delay. This function works only in the dark.

## Battery discharge protection

To prevent discharge of the vehicle battery when the ignition is switched off, some interior lights are switched off automatically after some time.

## Climate control

<b>Climate control systems</b> .....	106
Electronic climate control system .....	106
Auxiliary heater .....	111
Temperature preconditioning ..	111
<b>Air vents</b> .....	113
Adjustable air vents .....	113
Fixed air vents .....	114
<b>Maintenance</b> .....	114
Air intake .....	114
Air conditioning regular operation .....	114
Service .....	114

## Climate control systems

### Electronic climate control system







The dual zone climate control allows different temperatures for driver side and front passenger side.

In automatic mode, temperature, fan speed and air distribution are regulated automatically.



Controls for:

- temperature on driver side / \
- **MENU** enters the climate control settings menu in the Info Display
- fan speed ☼

- automatic mode **AUTO**
- temperature on front passenger side / \
- cooling **A/C**
- manual air recirculation 
- demisting and defrosting 
- heated rear window and exterior mirrors 
- heated windscreen 
- heated seats 
- ventilated seats 

Heated rear window  ↗ 27.

Heated exterior mirrors  ↗ 23.

Heated seats  ↗ 36.

Ventilated seats  ↗ 36.

Activated functions are indicated by the LED in the respective control.

The electronic climate control system is only fully operational when the engine is running.

Make sure the sun sensor on top of the instrument panel used by the electronic climate control system is not covered.

## Climate control settings menu

Climate setting menu can be displayed in the Info Display.

Info Display ↗ 106.

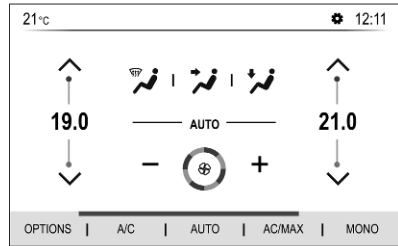

- air distribution 🌀, 🌀, 🌀
- fan speed 🌀
- temperature for driver and passenger side
- dual zone temperature synchronisation **MONO**
- cooling **A/C**
- automatic mode **AUTO**
- maximum air conditioning **AC/MAX**

## Automatic mode AUTO

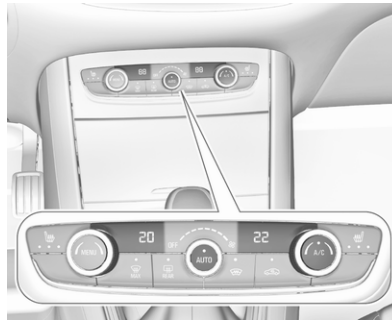

Basic setting for maximum comfort:

- Press **AUTO**, the air distribution and fan speed are regulated automatically.
- Open all air vents to allow optimised air distribution in automatic mode.

- Air conditioning must be activated for optimal cooling and demisting. Press **A/C** to switch on air conditioning. The LED in the button indicates activation.
- Set the preselected temperatures for driver and front passenger using the left and right rotary ring. Recommended temperature is 22 °C.

The automatic setting of the **AUTO** mode can be set:

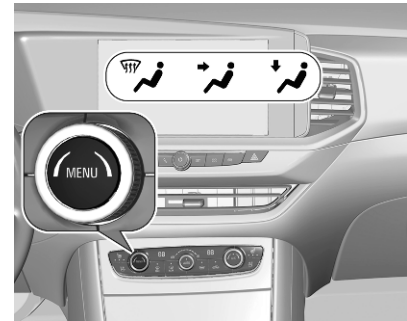

Press **MENU** to open the climate control settings menu.

Touch **OPTIONS** on the Info Display.

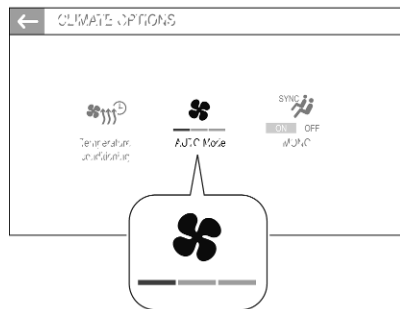

Press successively **AUTO** to select the desired automatic settings:

- one bar for a soft and silent air distribution.
- two bars for thermal comfort and silent air distribution.
- three bars for a dynamic and efficient air distribution.

### Manual settings

Climate control system settings can be changed by activating the following functions:

### Fan speed

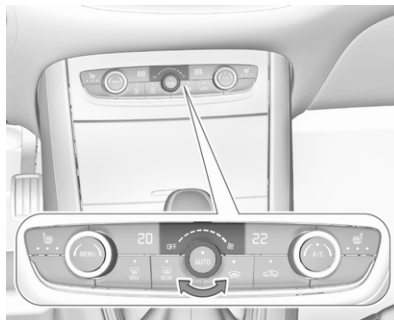

Adjust the air flow by turning rotary ring to the desired speed. Turn anticlockwise to decrease or turn clockwise to increase. Fan speed can also be changed in the climate control settings menu. Press **MENU** to enter the climate control settings menu.

Turn rotary ring anticlockwise as far as it will go: fan and cooling are switched off.

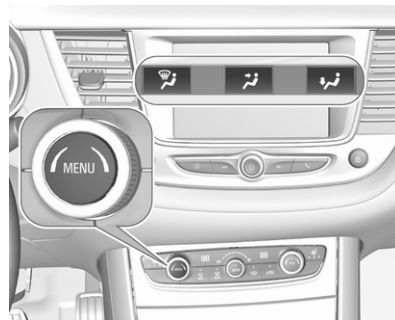

To return to automatic mode, press **AUTO**.

### Air distribution



Press **MENU** to enter the climate control settings menu.

Touch on the Info Display:

-  : to windscreen and front door windows
-  : to head area and rear seats via adjustable air vents
-  : to front and rear foot well and windscreen

To return to automatic air distribution, press **AUTO**.

## Temperature preselection / \

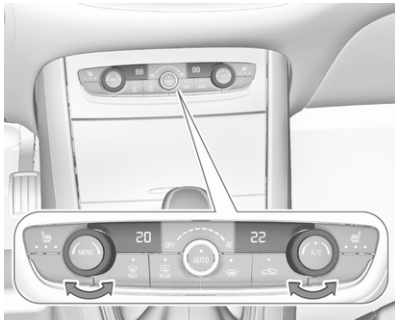

Set the preselected temperatures separately for the driver and the front passenger to the desired value using the left and right rotary ring. The rotary ring on the passenger side changes the temperature of the passenger side. The rotary ring on the driver's side changes the temperature of the driver's side or of both sides, depending on activation of synchronisation **MONO** in the climate control settings menu. Press **MENU** to enter the climate control settings menu.

Recommended temperature is 22 °C. Temperature is indicated in displays beside the rotary rings and in the climate settings menu.

If the minimum temperature **Lo** is set, the climate control system runs at maximum cooling, if cooling **A/C** is switched on.

If the maximum temperature **Hi** is set, the climate control system runs at maximum heating.

### Notice

If **A/C** is switched on, reducing the set cabin temperature can cause the engine to restart from an Autostop or inhibit an Autostop.

Stop-start system ↗ 120.

**Dual zone temperature synchronisation MONO or SYNC**  
Press **MENU** to enter the climate control settings menu.

Touch **OPTIONS** to open the climate options menu.

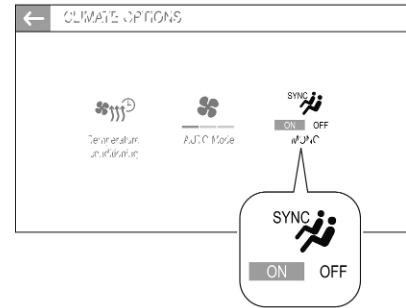

Set **SYNC** to **ON** to link passenger side temperature setting to the driver side  
Touch **MONO** or **SYNC** to link passenger side temperature setting to the driver side.

When passenger side control dial will be adjusted, synchronisation is deactivated.

### Air conditioning A/C

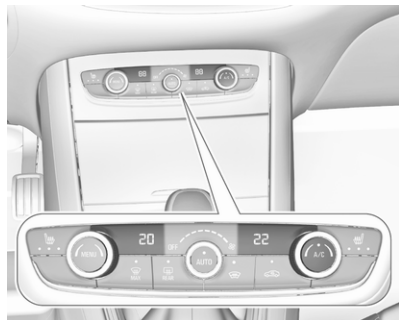

Press **A/C** to switch on cooling. The LED in the button illuminates to indicate activation. Cooling is only functional when the engine is running and climate control fan is switched on.

Press **A/C** again to switch off cooling.

The air conditioning system cools and dehumidifies (dries) when outside temperature is above a specific level. Therefore condensation may form and drip from under the vehicle.

If no cooling or drying is required, switch off the cooling system for fuel saving reasons.

### Maximum air conditioning AC/MAX

Press **MENU** to enter the climate control settings menu.

Touch **A/C MAX** to activate/deactivate maximum air conditioning.

The maximum air conditioning function sets the temperature as low as possible and adjusts the distribution to all air vents. In addition, it sets the air flow to maximum and activates the air recirculation.

### Manual air recirculation



Press  to activate the air recirculation mode. The LED in the button illuminates to indicate activation.

Press  again to deactivate recirculation mode.

### Warning





The exchange of fresh air is reduced in air recirculation mode. In operation without cooling, the air humidity increases, so the windows may mist up from inside. The quality of the passenger compartment air deteriorates, which may cause the occupants to feel drowsy.

In warm and very humid ambient air conditions, the windscreen may mist up from outside, when cold air is directed towards it. If windscreen mists up from outside, activate windscreen wiper and deactivate .

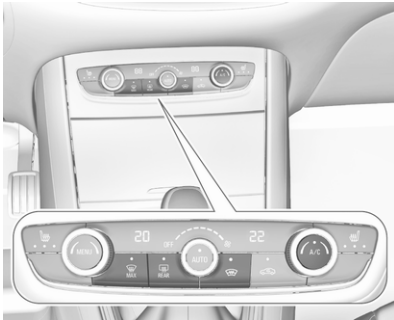



## Demisting and defrosting the windows



- Press . The LED in the button illuminates to indicate activation.
- Temperature and air distribution are set automatically and the fan runs at high speed.
- Switch on air conditioning by pressing **A/C**, if required.
- Switch on heated rear window .
- Switch on heated windscreen .
- To return to previous mode, press  again. To return to automatic mode, press **AUTO**.

## Notice

If  is pressed while the engine is running, an Autostop will be inhibited until  is pressed again.

If  is pressed while the engine is in an Autostop, the engine will restart automatically.

Stop-start system  120.

## Deactivation of electronic climate control system

Cooling, fan and automatic mode can be switched off by turning the rotary ring around the **AUTO** button anticlockwise.

Activation by switching on the fan or pressing **AUTO**.

Heated rear window, windscreen and exterior mirrors   27.

Heated seats   36.

## Auxiliary heater

### Air heater

Quickheat is an electric auxiliary air heater which automatically warms up the passenger compartment more quickly.

## Temperature preconditioning

The temperature preconditioning allows to heat or to ventilate the vehicle's interior with ambient air.

The temperature preconditioning can be programmed via the Info Display or the MyVauxhall App.



The operating status of the temperature preconditioning is shown by a LED.

- LED illuminates: A timer has been set.
- LED flashes: The system is operating.

The LED is extinguished at the end of the operation or when the temperature preconditioning is stopped using the remote control.

The temperature preconditioning can be programmed by using the Info Display.

### Notice

The temperature preconditioning is only activated if the ignition is off and the vehicle is locked.

If the charging level of the high voltage battery is below 50%, the temperature preconditioning is not activated.

When the vehicle is connected, battery charging takes precedence over pre-conditioning.

Consequently, it can only be activated if the battery is charged above a threshold fixed at 80%.

If a recurrent heating / ventilation is programmed and two heating / ventilation procedures are carried out without operating the vehicle, the programming is deactivated.

### Setting timer

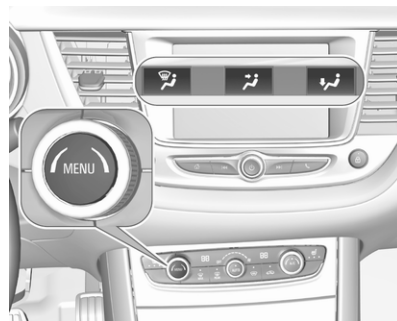

Press **MENU** .  
Touch **OPTIONS**.

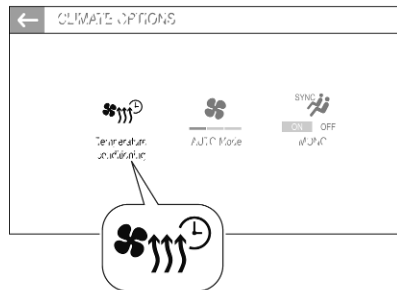

Select .

Touch **+** to define a new timer.

Touch **-**:**-**.

Enter time and day.

Press  to confirm the settings.

Press **ON** to activate the timer.

To delete a timer, press  at the top of the Info Display and delete the desired timer.

Confirm the deletion.

## Air vents

### Adjustable air vents

#### Air vents in the instrument panel

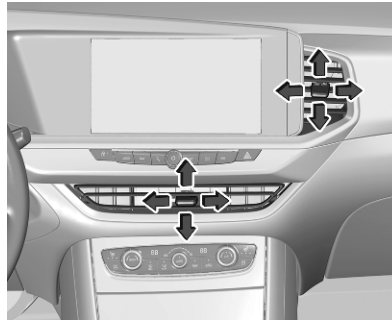

Direct the flow of air by tilting and swivelling the slats.

To close the vent, swivel the slats inwards.

#### Outer air vents in the instrument panel

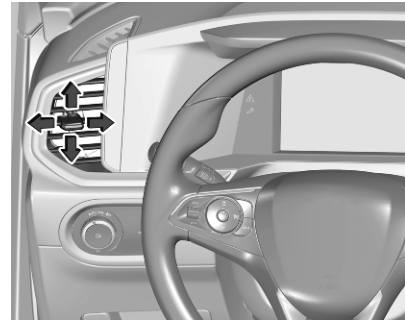

Direct the flow of air by tilting and swivelling the slats.

To close the vent, swivel the slats outwards.

At least two air vents must be open while cooling is on.

#### Warning

Do not attach any objects to the slats of the air vents. Risk of damage and injury in case of an accident.

## Fixed air vents

Additional air vents are located beneath the windscreen and door windows and in the foot wells.

## Maintenance

### Air intake



The air intake in front of the windscreen in the engine compartment must be kept clear to allow air intake. Remove any leaves, dirt or snow.

## Air conditioning regular operation

In order to ensure continuously efficient performance, cooling must be operated for a few minutes once a month, irrespective of the weather and time of year. Operation with cooling is not possible when the outside temperature is too low.

## Service

For optimal cooling performance, it is recommended to annually check the climate control system, starting three years after initial vehicle registration, including:

- functionality and pressure test
- heating functionality
- leakage check
- check of drive belts
- cleaning of condenser and evaporator drainage
- performance check

# Driving and operating

<b>Driving hints</b> .....	<b>116</b>	Fault .....	135	Rear view camera .....	174
Control of the vehicle .....	116	Interruption of power supply ....	135	Traffic sign assistant .....	175
Steering .....	116	<b>Manual transmission</b> .....	<b>135</b>	Lane departure warning .....	175
<b>Starting and operating</b> .....	<b>116</b>	<b>Drive systems</b> .....	<b>136</b>	Lane keep assist .....	177
New vehicle running-in .....	116	Drive modes .....	136	Advanced lane keep assist .....	179
Ignition switch positions .....	116	All-wheel drive .....	137	Driver alert .....	181
Power button .....	117	<b>Brakes</b> .....	<b>138</b>	<b>Charging</b> .....	<b>183</b>
Starting the engine .....	118	Antilock brake system .....	138	General information .....	183
Overrun cut-off .....	120	Parking brake .....	138	Charging types .....	183
Stop-start system .....	120	Brake assist .....	140	Charge cord .....	185
Parking .....	122	Hill start assist .....	141	Programmable charging .....	190
<b>Engine exhaust</b> .....	<b>123</b>	Regenerative braking .....	141	Charging status .....	191
Exhaust filter .....	123	<b>Ride control systems</b> .....	<b>142</b>	<b>Fuel</b> .....	<b>192</b>
Catalytic converter .....	124	Electronic Stability Control and		Fuel for petrol engines .....	192
AdBlue .....	124	Traction Control system .....	142	Fuel for diesel engines .....	192
<b>Automatic transmission electrified</b> .....	<b>128</b>	Selective ride control .....	143	Refuelling .....	193
<b>Automatic transmission</b> .....	<b>131</b>	Sport mode .....	144	Fuel consumption - CO <sub>2</sub> -	
Transmission display .....	131	<b>Driver assistance systems</b> .....	<b>145</b>	Emissions .....	195
Gear selection .....	131	Cruise control .....	145	<b>Trailer hitch</b> .....	<b>196</b>
Manual mode .....	133	Speed limiter .....	147	General information .....	196
Electronic driving programmes	134	Adaptive cruise control .....	149	Driving characteristics and	
		Forward collision alert .....	155	towing tips .....	196
		Active emergency braking .....	157	Trailer towing .....	197
		Front pedestrian protection .....	159	Towing equipment .....	197
		Parking assist .....	160	Trailer stability assist .....	200
		Advanced parking assist .....	163		
		Side blind spot alert .....	168		
		Night vision .....	169		
		Panoramic view system .....	171		

## Driving hints

### Control of the vehicle

#### Never coast with engine not running

Many systems will not function in this situation (e.g. brake servo unit, power steering). Driving in this manner is a danger to yourself and others.

All systems function during an Autostop.

Stop-start system ⇨ 120.

### Pedals

To ensure the pedal travel is uninhibited, there must be no mats in the area of the pedals.

Use only floor mats, which fit properly and are fixed by the retainers on the driver side.

## Steering

If power steering assist is lost because the engine stops or due to a system malfunction, the vehicle can be steered but may require increased effort.

## Starting and operating

### New vehicle running-in

Do not brake unnecessarily hard for the first few journeys.

During the first drive, smoke may occur because of wax and engine oil evaporating off the exhaust system. Park the vehicle in the open for a while after the first drive and avoid inhaling the fumes.

During the running-in period, fuel and engine oil consumption may be higher.

Additionally, the cleaning process of the exhaust filter may take place more often.

Exhaust filter ⇨ 123.

### Ignition switch positions

Turn key:

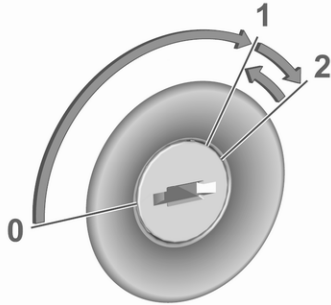

- 0 : ignition off: some functions remain active until key is removed or driver's door is opened, provided the ignition was on previously
- 1 : ignition on power mode: ignition is on, diesel engine is preheating, control indicators illuminate and most electrical functions are operable
- 2 : engine start: release key after engine has been started

### Steering wheel lock

Remove key from ignition switch and turn steering wheel until it engages.

### **⚠ Danger**

Never remove the key from ignition switch during driving as this will cause steering wheel lock.

### Power button



The electronic key must be inside the vehicle.

### Engine start

Operate the clutch pedal (manual transmission), the brake pedal and press **Start/Stop**.

### Ignition on power mode without starting the engine

Press **Start/Stop** without operating clutch or brake pedal. Control indicators illuminate and most electrical functions are operable.

### Engine and ignition off

Press **Start/Stop** briefly in each mode or when engine is running and vehicle is stationary. Some functions remain active until driver's door is opened, provided the ignition was on previously.

### Emergency shut off during driving

Press **Start/Stop** for 5 seconds  
 ⇨ 118. Steering wheel locks as soon as vehicle is stationary.

### Steering wheel lock

The steering wheel lock activates automatically when:

- The vehicle is stationary.
- The ignition has been switched off.

To release steering wheel lock, open and close driver's door and switch the ignition on power mode or start the engine directly.

**Warning**

If the vehicle battery is discharged, the vehicle must not be towed, tow-started or jump-started as the steering wheel lock cannot be disengaged.

**Operation on vehicles with electronic key system in case of failure**

If either the electronic key fails or the battery of the electronic key is weak, a message may be displayed in the Driver Information Centre.



Hold the electronic key with buttons outside at the marking on the steering column cover as shown in the illustration.

Operate the clutch pedal (manual transmission), the brake pedal and press **Start/Stop**.

This option is intended for emergencies only. Replace the electronic key battery as soon as possible ⇨ 8.

For unlocking or locking the doors, see fault in radio remote control unit or electronic key system ⇨ 9.

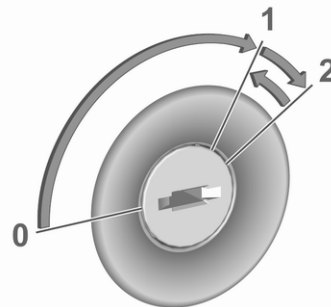
**Starting the engine****Vehicles with ignition switch**

Turn key to position 1 to release the steering wheel lock.

Manual transmission: operate clutch and brake pedal.

Automatic transmission: operate brake pedal and move selector lever to **P** or **N**.

Do not operate accelerator pedal.

Diesel engines: wait until control indicator  extinguishes.



Turn key briefly to position 2 and release after engine has been started.

Manual transmission: during an Autostop, the engine can be started by depressing the clutch pedal ↻ 120.

Automatic transmission: during an Autostop, the engine can be started by releasing the brake pedal ↻ 120.

### Vehicles with power button



- Manual transmission: operate clutch and brake pedal.
- Automatic transmission: operate brake pedal and move selector lever to **P** or **N**.
- Do not operate accelerator pedal.
- Press **Start/Stop** button.
- Release button after starting procedure begins. Diesel engine starts after control indicator  for preheating extinguishes.
- Before restarting or to switch off the engine when vehicle is stationary, press **Start/Stop** once more briefly.

To start the engine during an Autostop:

- Manual transmission: during an Autostop, the engine can be started by depressing the clutch pedal ↻ 120.
- Automatic transmission: during an Autostop, the engine can be started by releasing the brake pedal ↻ 120.

### Hybrid vehicles

- Press **Start/Stop** button.
- Depress brake pedal.
- Press **Start/Stop** button.
- Keep the brake pedal depressed until the activation of the hybrid system is confirmed by the illumination of **READY** in the Driver Information Centre and an acoustic signal.

### Emergency shut off during driving

If the engine needs to be switched off during driving in case of emergency, press **Start/Stop** for 5 seconds.

#### Danger

Switching off the engine during driving may cause loss of power support for brake and steering systems. Assistance systems and airbag systems are disabled. Lighting and brake lights will extinguish. Therefore power down the engine and ignition while driving only when required in case of emergency.

## Starting the vehicle at low temperatures

Starting the engine without additional heaters is possible down to  $-25\text{ }^{\circ}\text{C}$  for diesel engines and  $-30\text{ }^{\circ}\text{C}$  for petrol engines. Required is an engine oil with the correct viscosity, the correct fuel, performed services and a sufficiently charged vehicle battery. With temperatures below  $-30\text{ }^{\circ}\text{C}$  the automatic transmission requires a warming phase of approx. 5 minutes. The selector lever must be in position **P**.

## Turbo engine warm-up

Upon start-up, engine available torque may be limited for a short time, especially when the engine temperature is cold. The limitation is to allow the lubrication system to fully protect the engine.

## Overrun cut-off

The fuel supply is automatically cut off during overrun, i.e. when the vehicle is driven with a gear engaged but accelerator pedal is released.



Depending on driving conditions, the overrun cut-off may be deactivated.

## Stop-start system

The stop-start system helps to save fuel and to reduce the exhaust emissions. When conditions allow, it switches off the engine as soon as the vehicle is at a low speed or at a standstill, e.g. at a traffic light or in a traffic jam.

### Activation

The stop-start system is available as soon as the engine is started, the vehicle starts-off and the conditions as stated below in this section are fulfilled.

The system is ready to operate when the LED in the button  is not illuminated. To activate the system when the system is deactivated, press .

If the stop-start system is temporarily not available and the button  is pressed, the LED in the button flashes.

## Deactivation



Deactivate the stop-start system manually by pressing . The deactivation is indicated when the LED in the button illuminates.

## Autostop

### Vehicles with manual transmission

An Autostop can be activated at a standstill.

Activate an Autostop as follows:

- Depress the clutch pedal.
- Set the selector lever to neutral.
- Release the clutch pedal.

The engine will be switched off while the ignition stays on.

**Vehicles with automatic transmission**  
If the vehicle is at a standstill with depressed brake pedal, Autostop is activated automatically.

The engine will be switched off while the ignition stays on.

The stop-start system will be disabled on inclines of 12% or more.

### Indication



An Autostop is indicated by control indicator (A).

During an Autostop, the heating and brake performance will be maintained.

### Conditions for an Autostop

The stop-start system checks if each of the following conditions is fulfilled.

- The stop-start system is not manually deactivated.
- The driver's door is closed or the driver's seat belt is fastened.
- The vehicle battery is sufficiently charged and in good condition.
- The engine is warmed up.
- The engine coolant temperature is not too high.
- The engine exhaust temperature is not too high, e.g. after driving with high engine load.
- The ambient temperature is not too low or too high.
- The climate control system allows an Autostop.
- The brake vacuum is sufficient.
- The self-cleaning function of the exhaust filter is not active.
- The vehicle was driven at least at walking speed since the last Autostop.

Otherwise an Autostop will be inhibited.

### Notice

The Autostop may be inhibited for several hours after a battery replacement or reconnection.

Certain settings of the climate control system may inhibit an Autostop.

Climate control ⇨ 106.

Immediately after higher speed driving an Autostop may be inhibited.

New vehicle running-in ⇨ 116.

### Vehicle battery discharge protection

To ensure reliable engine restarts, several vehicle battery discharge protection features are implemented as part of the stop-start system.

### Power saving measures

During an Autostop, several electrical features such as auxiliary electric heater or rear window heating are disabled or switched to a power saving mode. The fan speed of the climate control system is reduced to save power.

## Restart of the engine by the driver

### Vehicles with manual transmission

Depress the clutch pedal without depressing the brake pedal to restart the engine.

### Vehicles with automatic transmission

The engine is restarted in the following cases:

- brake pedal released while the selector lever in position **D** or **M**
- brake pedal released or selector lever in position **N** when selector lever is moved to position **D** or **M**
- selector lever moved to position **R**

## Restart of the engine by the stop-start system

The selector lever must be in neutral to enable an automatic restart.

If one of the following conditions occurs during an Autostop, the engine will be restarted automatically by the stop-start system:

- stop-start system manually deactivated
- driver's seat belt unfastened and driver's door opened
- engine temperature too low
- charging level of vehicle battery below a defined level
- brake vacuum not sufficient
- vehicle driven at least at walking speed
- climate control system requests engine start
- air conditioning manually switched on

If an electrical accessory, e.g. a portable CD player, is connected to the power outlet, a brief power drop during the restart might be noticeable.

## Parking

### Warning

- Do not park the vehicle on an easily ignitable surface. The high temperature of the exhaust system could ignite the surface.
- Apply the parking brake.
- If the vehicle is on a level surface or uphill slope, engage first gear or set the selector lever to position **P**. On an uphill slope, turn the front wheels away from the kerb.  
If the vehicle is on a downhill slope, engage reverse gear or set the selector lever to position **P**. Turn the front wheels towards the kerb.
- Close the windows.
- Switch off the engine.
- Remove the ignition key from the ignition switch or switch off ignition on vehicles with power

button. Turn the steering wheel until the steering wheel lock is felt to engage.

- For hybrid vehicles, make sure **READY** is not illuminated in the Driver Information Centre.
- Lock the vehicle.
- Activate the anti-theft alarm system.
- The engine cooling fans may run after the engine has been switched off ⇨ 205.

### Caution

After running at high engine speeds or with high engine loads, operate the engine briefly at a low load or run in neutral for approx. 30 seconds before switching off, in order to protect the turbocharger.

### Notice

In the event of an accident with airbag deployment, the engine is switched off automatically if the vehicle comes to a standstill within a certain time.

In countries with extremely low temperatures it may be necessary to park the vehicle without applied parking brake. Make sure to park the vehicle on a level surface.

## Engine exhaust

### ⚠ Danger

Engine exhaust gases contain poisonous carbon monoxide, which is colourless and odourless and could be fatal if inhaled.



If exhaust gases enter the interior of the vehicle, open the windows. Have the cause of the fault rectified by a workshop.

Avoid driving with an open load compartment, otherwise exhaust gases could enter the vehicle.

## Exhaust filter

### Automatic cleaning process

The exhaust filter system filters soot particles out of the exhaust gases.



The start of saturation of the exhaust filter is indicated by the temporary illumination of  or , accompanied by a message in the Driver Information Centre.

As soon as the traffic conditions permit, regenerate the filter by driving at a vehicle speed of at least 40 mph until the control indicator extinguishes.

#### Notice

On a new vehicle, the first exhaust filter regeneration operations may be accompanied by a burning smell, which is normal. Following prolonged operation of the vehicle at very low speed or at idle, water vapour can be emitted at the exhaust on acceleration. This does not affect the behaviour of the vehicle or the environment.

#### Cleaning process not possible

If  or  stays on, accompanied by an audible signal and a message, this indicates that the exhaust filter additive level is too low.

The reservoir must be topped-up without delay. Seek the assistance of a workshop.

### Catalytic converter

The catalytic converter reduces the amount of harmful substances in the exhaust gases.

#### Caution

Fuel grades other than those listed on pages ⇨ 192, ⇨ 251 could damage the catalytic converter or electronic components.

Unburnt petrol will overheat and damage the catalytic converter. Therefore avoid excessive use of the starter, running the fuel tank dry and starting the engine by pushing or towing.

In the event of misfiring, uneven engine running, a reduction in engine performance or other unusual problems, have the cause of the fault rectified by a workshop as soon as possible. In an emergency, driving can be continued for a short period, keeping vehicle speed and engine speed low.

### AdBlue

#### General information

The selective catalytic reduction (BlueInjection) is a method to substantially reduce the nitrogen oxides in the exhaust emission. This is achieved by injecting a Diesel Exhaust Fluid (DEF) into the exhaust system. The ammonia released by the fluid reacts with nitrous gases (NO<sub>x</sub>) from the exhaust and turns it into nitrogen and water.

The designation of this fluid is AdBlue®. It is a non-toxic, non-flammable, colourless and odourless fluid which consists of 32% urea and 68% water.

#### Warning

Avoid contact of your eyes or skin with AdBlue.

In case of eye or skin contact, rinse off with water.

### Caution

Avoid contact of the paintwork with AdBlue.

In case of contact, rinse off with water.

AdBlue freezes at a temperature of approx.  $-11^{\circ}\text{C}$ . As the vehicle is equipped with an AdBlue preheater, the emissions reduction at low temperatures is ensured. The AdBlue preheater works automatically.

### Notice

Frozen and again liquefied AdBlue is usable without quality loss.

The typical AdBlue consumption is approx. 0.85 l per 600 miles, but can also be higher depending on driving behaviour (e.g. high load or towing).

### Level warnings

Depending on the calculated range of AdBlue, different messages are displayed in the Driver Information Centre. The messages and the restrictions are a legal requirement.

1. The first possible warning is **Top up emissions additive: Starting prevented in 1500 mi.**

When switching on the ignition, this warning will show up once briefly with the calculated range. Additionally, control indicator  will illuminate and a chime will sound. Driving is possible without any restrictions.

When driving, the message is displayed every 200 miles until the additive tank has been topped-up.

2. The next warning level is entered with a range below 350 miles. The message with the current range will always be displayed when ignition is switched on.

Additionally, control indicator  will flash and a chime will sound. Refill AdBlue before entering the next warning level.

When driving, the message is displayed every 30 seconds until

the additive tank has been topped-up.

3. The last warning level is entered when the AdBlue tank is empty. Restart of the engine is not possible. The following warning message will be displayed:

### Top up emissions additive: Starting prevented



Additionally, control indicator  will flash and a chime will sound.

Refill the tank to a level of at least 5 l of AdBlue, otherwise restarting of the engine is not possible.

### High emission warnings

In the event of a fault with the emissions control system, different messages are displayed in the Driver Information Centre. The messages and the restrictions are a legal requirement.

1. If a fault is detected for the first time, the warning **Emissions fault** is displayed.



Additionally, control indicators ,  and  will illuminate and a

chime will sound. Driving is possible without any restrictions.

If it is a temporary fault, the alert disappears during the next journey, after self-diagnosis of the emissions control system.

- If the fault is confirmed by the emission control system, the following message will be displayed:



**Emissions fault: Starting prevented in 650 miles.**

Additionally, control indicators ,  and  will illuminate and a chime will sound.

When driving, the message is displayed every 30 seconds while the fault persists.

- If the last warning level is entered, the following warning message will be displayed:

**Emissions fault: Starting prevented**

Additionally, control indicators ,  and  will illuminate and a chime will sound.

Consult a workshop for assistance.

### Refilling AdBlue

#### Caution

Only use AdBlue that complies with European standards DIN 70 070 and ISO 22241-1.

Do not use additives.

Do not dilute AdBlue.

Otherwise the selective catalytic reduction system could be damaged.

#### Notice

Whenever a filling pump with a nozzle for passenger cars is not available at a filling station, use only AdBlue bottles or canisters with a sealed refill adapter for refilling, to prevent splashback and overflow, and in order to ensure that the fumes from the tank are captured and do not emerge. AdBlue in bottles or canisters is available in many filling

stations and can be purchased e.g. at Vauxhall dealers and other retail outlets.

Since AdBlue has a limited durability, check the date of expiry before refilling.

#### Notice

Refill the tank to a level of at least 5 l to ensure that the new AdBlue level is being detected.

In case AdBlue refill is not successfully detected:

- Continuously drive the vehicle for 10 min making sure that vehicle speed is always higher than 12 mph.
- If AdBlue refill is detected successfully, AdBlue supply-driven warnings or limitations will disappear.

If AdBlue refill is still not detected, seek the assistance of a workshop.

If AdBlue must be refilled at temperatures below -11 °C, the refilling of AdBlue may not be detected by the system. In this



event, park the vehicle in a space with a higher ambient temperature until AdBlue is liquified.

**Notice**

When unscrewing the protective cap from the filler neck, ammonia fumes may emerge. Do not inhale as the fumes have a pungent smell. The fumes are not harmful by inhalation.

The AdBlue tank should be filled completely. This must be done if the warning message regarding prevention of an engine restart is already displayed.

The vehicle must be parked on a level surface.

The filler neck for AdBlue is located behind the fuel filler flap, which is located at right rear side of the vehicle.

The fuel filler flap can only be opened if the vehicle is unlocked.

1. Remove key from ignition switch.
2. Close all doors to avoid ammonia fumes entering the interior of the vehicle.

3. Release the fuel filler flap by pushing the flap ↗ 193.

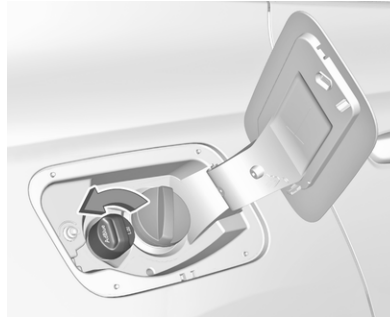

4. Unscrew protective cap from the filler neck.
5. Open AdBlue canister.
6. Mount one end of the hose on the canister and screw the other end on the filler neck.
7. Lift the canister until it is empty, or until the flow from the canister has stopped. This can take up to 5 minutes.
8. Place the canister on the ground to empty the hose, wait 15 seconds.

9. Unscrew the hose from the filler neck.

10. Mount the protective cap and turn clockwise until it engages.

**Notice**

Dispose of AdBlue canister according to environmental requirements. Hose can be reused after flushing with clear water before AdBlue dries out.

## Automatic transmission electrified

This vehicle is a plug-in hybrid vehicle. It has a combustion engine and an automatic transmission with integrated electrical engine which enables electrical driving and charging of the battery during the deceleration and the braking of the vehicle. Additionally, the battery can be charged using a cable, e.g., at domestic electric outlets or public charging stations. The all-wheel drive version has a second electrical engine for the rear axle.

### ⚠ Warning

Do not leave the vehicle when the propulsion system is running, the vehicle may move suddenly. You or others can be injured. To be sure the vehicle will not move, even if you are on even ground, make sure the parking brake is applied and **P** is selected.

### Caution

If the vehicle seems to accelerate slowly or not respond when you try to go faster, do not continue your journey. The electric drive unit could be damaged. Consult a workshop as soon as possible.

### Notice

In slippery conditions, operate the vehicle in **D** for enhanced riding and handling performance.

### ⚠ Warning

In the case of extreme temperatures or if the high voltage battery is almost fully charged, the brake force of the regenerative braking may be temporarily reduced. If the braking force is not sufficient, the driver has to be prepared to use the brake pedal.

### Caution

Spinning the tyres or holding the vehicle in one place on a hill using only the accelerator pedal may damage the electric drive unit. If you are stuck, do not spin the tyres. When stopping on a hill, use the brakes to hold the vehicle in place.

### Gear selection type A



Move the selector or press the respective buttons.

- P** : park position, front wheels are locked, engage only when the vehicle is stationary and the parking brake is applied
- R** : reverse gear, engage only when the vehicle is stationary
- N** : neutral
- D** : automatic mode
- B** : automatic mode with one-pedal driving and regenerative breaking

The selector lever is locked in **P**. Before unlocking, ensure that the ignition is on. Apply the brake pedal, press **UNLOCK** if necessary and move the selector lever to the desired mode.

The selector lever is locked in **P**. Before unlocking, ensure that the ignition is on. Apply the brake pedal, press **UNLOCK** if necessary and move the selector lever to the desired mode.

The engine can only be started with the selector lever in **P** or **N**. When position **N** is selected, press the brake pedal or apply the parking brake before starting.

Before engaging the reverse gear, come to a total stop. Apply the brake pedal, press **UNLOCK** if necessary and move the selector lever to **R**.

<b>Caution</b>
Shifting into <b>R</b> while the vehicle is moving forward could damage the electric drive unit. Only shift into <b>R</b> after the vehicle has been stopped.



**B** can only be activated if the selector lever is in **D**. To shift into **B**, push the selector lever from **D** backwards. To shift out of **B**, push the selector lever from **D** backwards again.

**Gear selection type B**

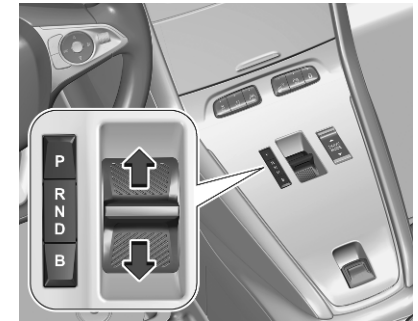

Move the selector or press the respective buttons.

- P** : park position, wheels are locked, engage only when the vehicle is stationary, engaged automatically when driver's door is opened or engine is switched off
- R** : reverse gear, engage only when the vehicle is stationary

- N** : neutral
- D** : automatic mode
- B** : automatic mode with one-pedal driving and regenerative braking

Shifting always starts from a centre position and is operated by moving the selector. Once operated, the selector will return to the centre position. The selected mode is indicated in the Driver Information Centre.

The selector lever is locked in **P**. To shift into **P**, press button **P**.

The electric drive unit automatically shifts to **P** if

- the engine is switched off
- the driver's door is opened while the vehicle's speed is below 1 mph



To activate **B**, select **D** and press button **B**

Do not accelerate while engaging a gear. Never depress the accelerator pedal and brake pedal at the same time.

When a gear is engaged, the vehicle slowly begins to creep when the brake is released.

### Regenerative braking **B**

Regenerative braking generates electrical energy resulting from engine braking to charge the high

voltage battery. Regenerative power may be limited when the high voltage battery is fully charged.

If **B** is selected, energy is regenerated when the accelerator pedal is released. Releasing the accelerator pedal without operating the brake pedal also reduces the vehicle speed significantly.

Use **B** when driving down steep hills, in deep snow, in mud or in stop-and-go traffic.

### Deactivating the automatic operation of **P** mode for electric vehicles

The procedure for the deactivation of the automatic operation of **P** mode also deactivates the automatic operation of the electric parking brake.

For this procedure, refer to the description of the automatic parking brake.

Parking brake ⇨ 138

## Automatic transmission

The automatic transmission permits automatic gearshifting (automatic mode) or manual gearshifting (manual mode).

Manual mode ⇨ 133.

## Transmission display

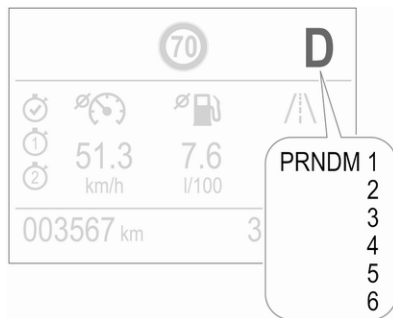

The mode or selected gear is shown in the Driver Information Centre.

In automatic mode, the driving programme is indicated by **D**.

In manual mode, **M** and the number of the selected gear is indicated.

**R** indicates reverse gear.

**N** indicates neutral position.

**P** indicates park position.

## Gear selection

### Gear selection type A



Move the selector or press the respective buttons.

**P** : park position, front wheels are locked, engage only when the vehicle is stationary and the parking brake is applied

**R** : reverse gear, engage only when the vehicle is stationary

**N** : neutral

**D** : automatic mode

**M** : manual mode

The selector lever is locked in **P**. Before unlocking, ensure that the ignition is on. Apply the brake pedal, press **UNLOCK** if necessary and move the selector lever to the desired mode.

The selector lever is locked in **P**. Before unlocking, ensure that the ignition is on. Apply the brake pedal, press **UNLOCK** if necessary and move the selector lever to the desired mode.

The engine can only be started with the selector lever in **P** or **N**. When position **N** is selected, press the brake pedal or apply the parking brake before starting.

Before engaging the reverse gear, come to a total stop. Apply the brake pedal, press **UNLOCK** if necessary and move the selector lever to **R**.

**Caution**

Shifting into **R** while the vehicle is moving forward could damage the electric drive unit. Only shift into **R** after the vehicle has been stopped.

**Gear selection type B**



Move the selector or press the respective buttons.

- P** : park position, wheels are locked, engage only when the vehicle is stationary, engaged automatically when driver's door is opened or engine is switched off
- R** : reverse gear, engage only when the vehicle is stationary
- N** : neutral
- D** : automatic mode
- B** : manual mode

Shifting always starts from a centre position and is operated by moving the selector. Once operated, the selector will return to the centre position. The selected mode is indicated in the Driver Information Centre.

The selector lever is locked in **P**. To shift into **P**, press button **P**. The electric drive unit automatically shifts to **P** if

**P** locks the front wheels. It is the recommended mode when starting the propulsion system because the vehicle cannot move easily.

The electric drive unit automatically shifts to **P** if

- the engine is switched off
- the driver's door is opened while the vehicle's speed is below 1 mph

**Gear selection type C**

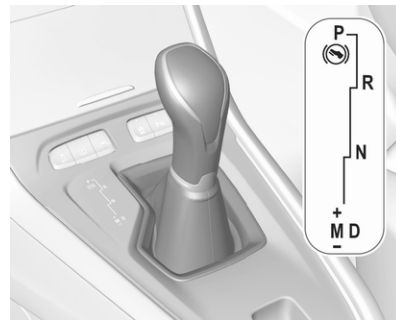

Move the selector lever in the shifting gate as shown in the illustration above.

- P** : park position, front wheels are locked, engage only when the vehicle is stationary and the parking brake is applied
- R** : reverse gear, engage only when the vehicle is stationary

- N** : neutral
- D** : automatic mode
- M** : manual mode
- +** : upshift in manual mode
- : downshift in manual mode

The selector lever is locked in **P** and can only be moved when the ignition is on and the brake pedal is applied.

The engine can only be started with the selector lever in position **P** or **N**. When position **N** is selected, press the brake pedal or apply the parking brake before starting.

Do not accelerate while engaging a gear. Never depress the accelerator pedal and brake pedal at the same time.

When a gear is engaged, the vehicle slowly begins to creep when the brake is released.

### Engine braking

To utilise the engine braking effect, select a lower gear in good time when driving downhill, see manual mode.

### Rocking the vehicle

Rocking the vehicle is only permissible if the vehicle is stuck in sand, mud or snow. Move the selector lever between **D** and **R** in a repeat pattern. Do not race the engine and avoid sudden acceleration.

### Manual mode

The selected gear is indicated in the Driver Information Centre.

If a higher gear is selected when vehicle speed is too low, or a lower gear when vehicle speed is too high, the shift is not executed. This can cause a message in the Driver Information Centre.

In manual mode, no automatic shifting to a higher gear takes place at high engine revolutions.

### Gear selection type A



Shift into **D**.

Push the selector lever from **D** backwards to shift in **M**.

Pull steering wheel paddles to select gears manually.

Pull right paddle **+** to shift to a higher gear.

Pull left paddle **-** to shift to a lower gear.

Multiple pulls allow gears to be skipped.

### Gear selection type B



Select **D**.

Press **M**.

Pull steering wheel paddles to select gears manually.

Pull right paddle **+** to shift to a higher gear.

Pull left paddle **-** to shift to a lower gear.

Multiple pulls allow gears to be skipped.

### Gear selection type C

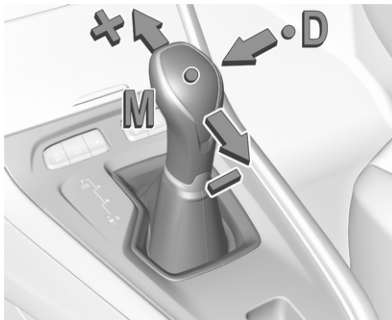

Move selector lever out of position **D** towards the left in position **M**.

Tap the selector lever to the front **+** to shift to a higher gear.

Tap the selector lever to the rear **-** to shift to a lower gear.

### Gear shift indication

The symbol **▲** or **▼** with a number beside it is indicated when gearshifting is recommended for fuel saving reasons.

Shift indication appears only in manual mode.

### Electronic driving programmes

- Following a cold start, the operating temperature programme increases engine speed to quickly bring the catalytic converter to the required temperature.
- Special programmes automatically adapt the shifting points when driving up inclines or down hills.
- In snowy or icy conditions or on other slippery surfaces, the electronic transmission control enables the driver to select manually first, second or third gear for starting off.

### Kickdown

Pressing down the accelerator pedal beyond the kickdown detent will lead to maximum acceleration independent of selected driving mode. The transmission shifts to a lower gear depending on engine speed.



## Fault

In the event of a fault a message is displayed in the Driver Information Centre.

Vehicle messages ⇨ 91.

Electronic transmission control enables only third gear. The transmission no longer shifts automatically.

Do not drive faster than 62 mph.

Have the cause of the fault remedied by a workshop.

## Interruption of power supply

In the event of an interruption of power supply, the selector lever cannot be moved out of the **P** position.

If the vehicle battery is discharged, start the vehicle using jump leads ⇨ 233.

If the vehicle battery is not the cause of the fault, release the selector lever.

1. Apply the parking brake.

2. Release the selector lever trim from the centre console. Poke with a finger into the leather socket below the selector lever and push the trim upwards.

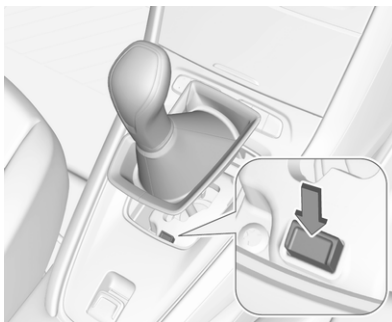

3. Push down the button and move the selector lever out of **P**. Have the cause of the power supply interruption remedied by a workshop.
4. Mount the selector lever trim onto the centre console and refit.

## Manual transmission

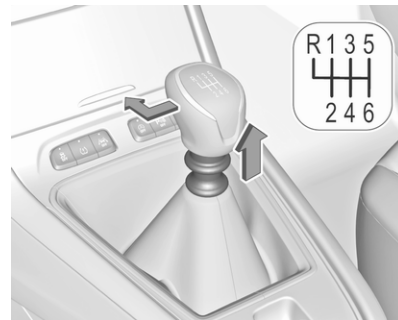

To engage reverse on 6-speed transmission, depress the clutch pedal, pull the ring under the selector lever and move the selector lever quite to the left and front.

If the gear does not engage, set the selector lever to neutral, release the clutch pedal and depress again. Then repeat gear selection.

Do not slip the clutch unnecessarily. When operating, depress the clutch pedal completely. Do not use the pedal as a foot rest.

When clutch slip is detected for a specific time, the engine power will be reduced. A warning is displayed in the Driver Information Centre. Release the clutch.

**Caution**

It is not advisable to drive with the hand resting on the selector lever.

Gear shift indication ↗ 83.

Stop-start system ↗ 120.

## Drive systems

### Drive modes

For hybrid vehicles, the following drive modes are selectable:

- **AWD mode**
- **Sport mode**
- **Hybrid mode**
- **Electric mode**

Each drive mode corresponds to a different vehicle setting.



To select the respective drive mode, use the drive mode selector. The selected drive mode is indicated in the Driver Information Centre and in

the Info Display. Selecting a drive mode is only possible if **READY** is displayed in the Driver Information Centre.

#### Notice

To maintain the engine oil quality the combustion engine can run independent of selected drive mode.

Hybrid system active ↗ 82.

### AWD

The all-wheel drive mode improves the grip of the vehicle. The vehicle is driven by front and rear axle.

Depending on the driving situation and the charge level of the high voltage battery, the vehicle can be driven 100% electrically.

All-wheel drive ↗ 137

### Sport

This mode combines the power of the combustion engine and the electrical engine for a dynamic driving style.

## Hybrid

Hybrid mode focuses on optimising the vehicle's fuel consumption. Combustion engine and electrical engine operate together or in alternation depending on driving conditions and driving style.

## Electric

### Notice

Electric mode may not be available if the outside temperature is not within the range between 0 °C and 45 °C.

In this mode, the vehicle is driven by the electric engine only. Electric mode is the default mode.

Electric propulsion is available for speeds below 84 mph.

The illumination of the LED below the interior mirror indicates electric operation of the vehicle. This LED is visible from outside the vehicle.

## Engine oil dilution

If the internal combustion engine is started frequently without reaching the operating temperature, engine oil

will be diluted by fuel. For an internal combustion engine, this is a normal process. The engine oil evaporates from the fuel while the engine is operating.

To prevent dilution, the following actions are recommended:

- Charge the high voltage battery as often as possible via an external power source.
- Prefer driving in electric mode.
- Make a trip in hybrid mode for more than 45 minutes once each month. Alternatively, make trip in sport mode for at least 30 minutes once each month.

If a message is displayed indicating that the electric mode is not available and automatic operation is in progress, it is recommended to do the following: Drive at least 60 miles on a motorway or 90 minutes continuously.

## All-wheel drive

The all-wheel drive system enhances driving characteristics and stability, and helps to achieve the best possible driveability.

In all-wheel drive mode, the front axle is driven by the combustion engine or the electrical engine, the rear axle is driven by a second electrical engine.



All-wheel drive mode can be activated using the driving mode switch. Activation is shown in the Driver Information Centre and the Info Display.

Driver Information Centre ⇨ 87

Info Display ⇨ 88

All-wheel drive is available for speeds below 84 mph.

## Brakes

The brake system comprises two independent brake circuits.

If a brake circuit fails, the vehicle can still be braked using the other brake circuit. However, braking effect is achieved only when the brake pedal is depressed firmly. Considerably more force is needed for this. The braking distance is extended. Seek the assistance of a workshop before continuing the journey.

When the engine is not running, the support of the brake servo unit disappears once the brake pedal has been depressed once or twice. Braking effect is not reduced, but braking requires significantly greater force. It is especially important to bear this in mind when being towed.

Control indicator  82.

## Antilock brake system

Antilock brake system (ABS) prevents the wheels from locking.

ABS starts to regulate brake pressure as soon as a wheel shows a tendency to lock. The vehicle remains steerable, even during hard braking.

ABS control is made apparent through a pulse in the brake pedal and the noise of the regulation process.

For optimum braking, keep the brake pedal fully depressed throughout the braking process, despite the fact that the pedal is pulsating. Do not reduce the pressure on the pedal.

When braking in an emergency, the hazard warning flashers are switched on automatically depending on the force of deceleration. They are switched off automatically the first time you accelerate.

After starting off, the system performs a self-test which may be audible.



Control indicator  83.

## Fault

### Warning

If there is a fault in the ABS, the wheels may be liable to lock due to braking that is heavier than normal. The advantages of ABS are no longer available. During hard braking, the vehicle can no longer be steered and may swerve.

Have the cause of the fault remedied by a workshop.

## Parking brake

### Warning

Before leaving the vehicle, check parking brake status. Control indicator  illuminate constantly when electric parking brake is applied.

## Electric parking brake



### Applying when vehicle is stationary

#### **⚠ Warning**

Pull switch (P) for a minimum of 1 second until control indicator (P) illuminates constantly and electric parking brake is applied ↗ 82. The electric parking brake operates automatically with adequate force. Before leaving the vehicle, check the electric parking brake status. Control indicator (P) ↗ 82.

The electric parking brake can always be activated, even if the ignition is off.

Do not operate electric parking brake system too often without engine running as this will discharge the vehicle battery.

#### **Releasing**

Switch on ignition. Keep foot brake pedal depressed and then push switch (P).

#### **Drive away function**

Vehicles with manual transmission: Depressing the clutch pedal and then slightly releasing the clutch pedal and slightly depressing the accelerator pedal releases the electric parking brake automatically. This is only possible if the automatic operation of the electric parking brake is activated. It is not possible when switch (P) is pulled at the same time.

Vehicles with automatic transmission: Engaging **D** and then depressing the accelerator pedal releases the electric parking brake automatically. This is only possible if the automatic

operation of the electric parking brake is activated. It is not possible when switch (P) is pulled at the same time.

#### **Braking when vehicle is moving**

When the vehicle is moving and the switch (P) is kept pulled, the electric parking brake system will decelerate the vehicle. As soon as the switch (P) is released, braking will be stopped.

The antilock brake system and the Electronic Stability Control stabilise the vehicle while the switch (P) is kept pulled. If an error of the electric parking brake occurs, a warning message is displayed in the Driver Information Centre. If the antilock brake system and the Electronic Stability Control fail, one or both indicators (ABS) and (ESC) illuminate in the Driver Information Centre. In this case, stability can only be provided by repeatedly pulling and pushing the switch (P) until the vehicle is immobilised.

**Automatic operation**

Automatic operation includes automatic application and automatic release of the electric parking brake.

The electric parking brake can also be applied or released manually by using the switch (P).

Automatic application:

- The electric parking brake is automatically applied when the vehicle is stationary and the ignition is switched off.
- (P) illuminates in the Driver Information Centre and a display message pops up to confirm the application.

Automatic release:

- Parking brake releases automatically after moving off.
- (P) extinguishes in the Driver Information Centre and a display message pops up to confirm the release.

If the vehicle is equipped with an automatic transmission and the brake is not released automatically, make sure the front doors are correctly closed.

**Deactivation of automatic operation**

1. Start the engine.
2. If the parking brake is released, apply the parking brake pulling the switch (P).
3. Take your foot off the brake pedal.
4. Press the switch (P) for at least 10 seconds and maximum 15 seconds.
5. Release the switch (P).
6. Press and hold the brake pedal.
7. Pull the switch (P) for 2 seconds.

The deactivation of the automatic operation of the electric parking brake is confirmed by (P) illuminating in the Driver Information Centre ↗ 82. The electric parking brake can only be applied and released manually.

To reactivate the automatic operation, repeat the steps described above.

**Functionality check**

When the vehicle is not moving, the electric parking brake might be applied automatically. This is done to check the system.

**Fault**

Failure mode of electric parking brake is indicated by a control indicator (P) and by a vehicle message which is displayed in the Driver Information Centre.

Vehicle messages ↗ 91.

Control indicator (P) flashes: electric parking brake is not fully applied or released. When continuously flashing, release electric parking brake and retry applying.

**Brake assist**

If brake pedal is depressed quickly and forcefully, maximum brake force is automatically applied.

Operation of brake assist might become apparent by a pulse in the brake pedal and a greater resistance when depressing the brake pedal.

Maintain steady pressure on the brake pedal as long as full braking is required. Maximum brake force is automatically reduced when brake pedal is released.

## Hill start assist

The system helps prevent unintended movement when driving away on inclines.

When releasing the brake pedal after stopping on an incline, brakes remain on for further 2 seconds. The brakes release automatically as soon as the vehicle begins to accelerate.

## Regenerative braking

Regenerative braking generates electrical energy resulting from braking to charge the high voltage battery. Regenerative power may be limited when the high voltage battery is fully charged.

If the selector lever is in **D**, energy is recuperated when the brake pedal is depressed.

If the selector lever is in **B**, energy is recuperated when the accelerator pedal is lifted.

**B** can only be activated if the selector lever is in **D**.

To shift into **B**, push the selector lever from **D** backwards.

To shift out of **B**, push the selector lever from **D** backwards again.

Automatic transmission electrified  
⇨ 128

## One-pedal driving

With one-pedal driving, the accelerator pedal can be used to control the deceleration of the vehicle down to a complete stop. The deceleration provided by one-pedal driving provides full regenerative braking by charging the high voltage battery.

Quick releasing of the accelerator pedal will result in aggressive deceleration. Slow releasing of the accelerator pedal will allow the deceleration of the vehicle to be adjusted as desired.

To use one-pedal driving, shift into **B**. Press the accelerator pedal to achieve the desired speed.

## Ride control systems

### Electronic Stability Control and Traction Control system

Electronic Stability Control (ESC) improves driving stability when necessary, regardless of the type of road surface or tyre grip.

As soon as the vehicle starts to swerve (understeer / oversteer), engine output is reduced and the wheels are braked individually.

ESC operates in combination with the traction control system. It prevents the driven wheels from spinning.

The traction control system is a component of the ESC.

The traction control system improves driving stability when necessary, regardless of the type of road surface or tyre grip, by preventing the driven wheels from spinning.

As soon as the driven wheels starts to spin, engine output is reduced and the wheel spinning the most is braked

individually. This considerably improves the driving stability of the vehicle on slippery road surfaces.



ESC and traction control system are operational after each engine start as soon as the control indicator  extinguishes.

When ESC and traction control system operate,  flashes.

#### Warning

Do not let this special safety feature tempt you into taking risks when driving.

Adapt speed to the road conditions.

Control indicator  ⇨ 84.

## Deactivation

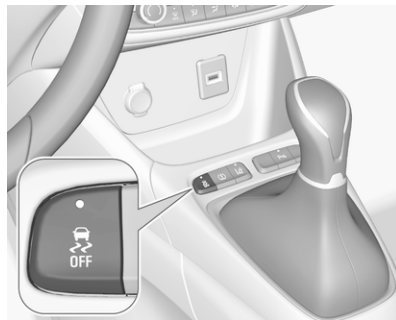

ESC and traction control system can be deactivated, everytime it is required: press .

The LED in the button  illuminates.

A status message appears in the Driver Information Centre when ESC and traction control system are deactivated.

ESC and traction control system are reactivated by pressing the  button again, by applying the brake or in the case that the vehicle is driven faster than 30 mph.



The LED in the button  extinguishes when ESC and traction control system are reactivated.

ESC and traction control system are also reactivated the next time the ignition is switched on.

## Fault

If there is a fault in the system, the control indicator  illuminates continuously and a message appears in the Driver Information Centre. The system is not operational.

Have the cause of the fault remedied by a workshop.

## Selective ride control

### Caution

The vehicle is designed to drive principally on-road, but it also enables driving off-road occasionally.

However, do not drive on terrain where the vehicle could be damaged due to obstacles, such

as stones among others and on terrain with steep inclines and poor grip.

Do not cross waters.

### Caution





When driving off-road, sudden motion and manoeuvres can cause a collision or losing control.

Selective ride control is designed to optimise traction in low-grip conditions (snow, mud and sand).

It adapts to the terrain by acting on the front wheels, in doing so this saves the weight normally associated with a more conventional four wheel drive system.



Selective ride control allows to choose between five driving modes by turning the control:

- ESC off mode 
- standard mode 
- snow mode 
- mud mode 
- sand mode 

An LED illuminates and a status message appears in the Driver Information Centre to confirm the chosen mode.

### ESC off mode

The ESC and Traction Control are deactivated in this mode.

ESC and Traction Control are reactivated automatically from 30 mph or everytime the ignition is switched on.

### Standard mode

This mode is calibrated for a low level of wheel spin, based on the different types of grip generally encountered in normal day to day driving.

Everytime the ignition is switched off, the system is automatically reset to this mode.

### Snow mode

This mode adapts to the grip conditions encountered by each wheel when starting.

When advancing, the system optimises wheel spin to guarantee the best acceleration based on the available traction. Recommended in cases of deep snow and steep inclines.

This mode is active up to a speed of 30 mph.

### Mud mode

This mode allows considerable wheel spin at start-up for the wheel with the least grip, this removes mud and re-establishes traction.

Simultaneously, the wheel with the most grip is provided with the most torque possible.

This mode is active up to a speed of 50 mph.

### Sand mode

This mode allows a small amount of simultaneous wheel spin on the two drive wheels, enabling the vehicle to advance and reduce the risk of sinking.

This mode is active up to a speed of 75 mph.

#### Caution

Do not use the other modes on sand as the vehicle may become stuck.

## Sport mode



Sport mode adapts the settings of some vehicle systems to a sportier driving style.

### Activation

Press **SPORT** when engine is running.

LED in the button illuminates when sport mode is active and a status message appears in the Driver Information Centre.

## Deactivation

Briefly press **SPORT**. Sport mode is deactivated the next time the ignition is switched on.

## Driver assistance systems

### Warning

Driver assistance systems are developed to support the driver and not to replace the driver's attention.

The driver accepts full responsibility when driving the vehicle.

When using driver assistance systems, always take care regarding the current traffic situation.

## Cruise control

The cruise control can store and maintain speeds above 25 mph. Additionally at least the third gear must be engaged on manual transmission, on automatic transmission position **D** or the second or a higher gear in position **M** must be selected.

Deviations from the stored speeds may occur when driving uphill or downhill.

The system maintains the vehicle speed at the preset speed by the driver, without any action on the accelerator pedal.



The preset speed can be exceeded temporarily by pressing the accelerator pedal firmly.

The status and preset speed is displayed in the Driver Information Centre.

Do not use the cruise control if it is not advisable to maintain a constant speed.

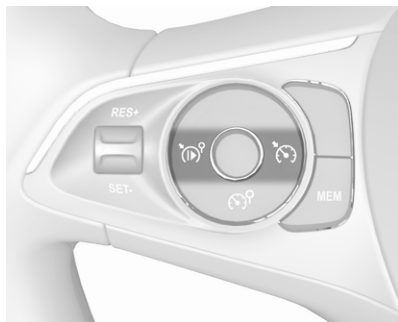
## Switching on the system



Press , symbol  and a message are displayed in the Driver Information Centre. The system is still not active.

## Activation of the functionality

### Setting speed by the driver

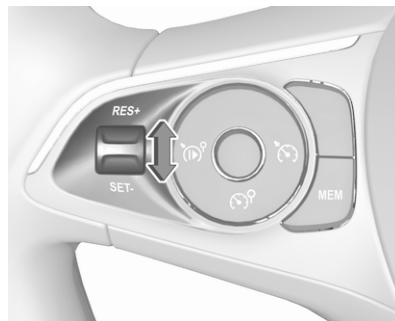

Accelerate to the desired speed and move thumb wheel once briefly to **SET/-**. The current speed is stored and maintained. Accelerator pedal can be released.

The preset speed can then be changed by moving thumb wheel to **RES/+** to increase or **SET/-** to decrease the speed. Move thumb wheel repeatedly to change speed in small steps, move and hold to change speed in large steps.

Speed value is indicated in the Driver Information Centre.

### Adopting speed by the speed limit recognition

The intelligent speed adaptation informs the driver when a speed limit is detected by the speed limit recognition. The detected speed limit can be used as new value for the cruise control.

Using the camera at the top of the windscreen, this system detects and reads speed limit and end of speed limit signs.

If the cruise control is active, the recognised speed limit will be displayed in the Driver Information Centre and **MEM** illuminates.

Press **MEM** on the steering wheel to request saving of the suggested speed.

Press **MEM** on the steering wheel once more to confirm and save the new speed setting.

This speed is the new value for the cruise control.

The function can be deactivated or activated in the personalisation menu ↗ 92.

### Exceeding the set speed

Vehicle speed can be increased by depressing the accelerator pedal. When the accelerator pedal is released, the previously stored speed is resumed.

### Deactivation of the functionality

Press , cruise control is in pause mode and a message is displayed. The vehicle is driven without cruise control.

Cruise control is deactivated, but not switched off. Last stored speed remains in memory for later speed resume.

Cruise control is deactivated automatically:

- The brake pedal is depressed.
- Vehicle speed is below 25 mph.

- The Traction Control system or Electronic Stability Control is operating.
- The selector lever is in **N** (automatic transmission), first or second gear (manual transmission).

### Resume stored speed

Move thumb wheel to **RES/+** at a speed above 25 mph. The stored speed will be obtained.

### Switching off the system

Press , the cruise control mode is deselected and the cruise control indication extinguishes in the Driver Information Centre.

Pressing  to activate the speed limiter deactivates cruise control.

Switching off the ignition cancels any programmed speed value.

### Fault

In the event of a cruise control fault, the speed is cleared resulting in flashing of the dashes.

The speed limit recognition may not operate correctly if traffic signs do not comply with the Vienna Convention on Road Signs and Signals.

### Speed limiter

The speed limiter prevents the vehicle from exceeding a preset maximum speed.

The maximum speed can be set at speeds above 18 mph.



The driver can accelerate the vehicle up to the preset speed. Deviations from the limited speed may occur when driving downhill.

The preset speed can be exceeded temporarily by pressing the accelerator pedal fully.

The status and preset speed limit are displayed in the Driver Information Centre.

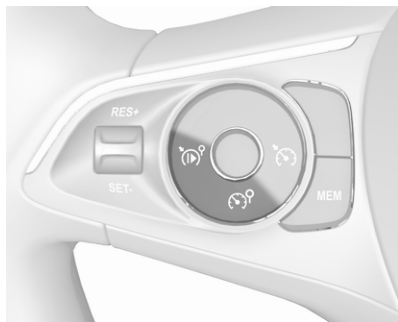
### Switching on the system



Press , symbol  and a message are displayed in the Driver Information Centre. The system is still not active.

### Activation of the functionality

#### Setting speed by the driver

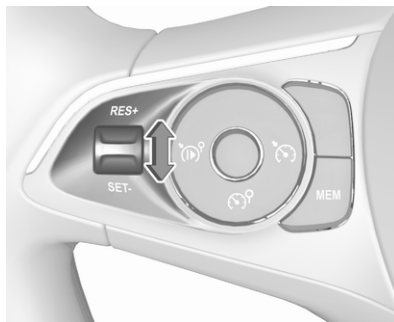

Accelerate to the desired speed and move thumb wheel once briefly to **SET/-**. The current speed is stored as maximum speed.

The preset maximum speed can be set by pressing thumb wheel to **RES/+** to increase or **SET/-** to decrease the desired maximum speed. Move thumb wheel repeatedly to change speed in small steps, move and hold to change speed in large steps.

Speed value is indicated in the Driver Information Centre.

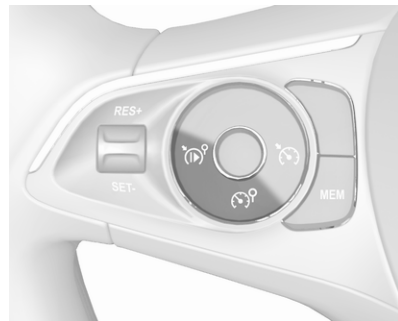

Press  to activate speed limiter.

#### Adopting speed by the speed limit recognition

The intelligent speed adaptation informs the driver when a speed limit is detected by the speed limit recognition. The detected speed limit can be used as new value for the speed limiter.

Using the camera at the top of the windscreen, this system detects and reads speed limit and end of speed limit signs.

If the speed limiter is active, the recognised speed limit will be displayed in the Driver Information Centre and **MEM** illuminates.

Press **MEM** on the steering wheel to request saving of the suggested speed limit.

Press **MEM** on the steering wheel once more to confirm and save the new speed setting.

This speed is the new value for the speed limiter.

The function can be activated or deactivated in the personalisation menu ↗ 92.

### Exceeding the speed limit

In the event of an emergency, it is possible to exceed the speed limit by depressing the accelerator pedal fully. In this case the preset speed value flashes.

Release the accelerator pedal and the speed limiter function is reactivated once a speed lower than the limit speed is obtained.

### Deactivation of the functionality

Press , speed limiter is in pause mode and a message is displayed. The vehicle is driven without speed limiter.

Speed limiter is deactivated, but not switched off. Last stored speed remains in memory for later speed resume.

### Resume limit speed

Press , the stored speed limit will be obtained.

### Switching off the system

Press , the speed limiter mode is deselected and the speed limit indication extinguishes in the Driver Information Centre.

Pressing  to activate cruise control deactivates speed limiter.

The preset speed remains in the memory when the ignition is switched off.

### Fault

In the event of a speed limiter fault, the speed is cleared resulting in flashing of the dashes.

The speed limit recognition may not operate correctly if traffic signs do not comply with the Vienna Convention on Road Signs and Signals.

### Adaptive cruise control

The adaptive cruise control is an enhancement to the conventional cruise control with the additional feature of maintaining a certain following distance to the vehicle ahead. It uses radar and camera sensors to detect the vehicles ahead. If no vehicle is detected in the driving path, the adaptive cruise control will behave like a conventional cruise control.

The adaptive cruise control automatically decelerates the vehicle when approaching a slower moving vehicle. It then adjusts the vehicle speed to follow the vehicle ahead at the selected following distance. The

vehicle speed increases or decreases to follow the vehicle ahead, but will not exceed the set speed. It may apply limited braking with activated brake lights.

If the vehicle ahead accelerates or changes lane, the adaptive cruise control progressively accelerates the vehicle to return to the stored set speed. If the driver operates a the turn lights to overtake a slower vehicle, the adaptive cruise control allows the vehicle to temporarily approach the vehicle ahead to help passing it. However, the set speed will never be exceeded.



The adaptive cruise control can store set speeds over 19 mph for manual transmission. If the vehicle ahead is moving too slowly and the selected following distance cannot be maintained anymore, a warning chime is given and a message is displayed in the Driver Information Centre. The message prompts the driver to take back control of the vehicle. On vehicles with automatic transmission, the system can brake the vehicle until a full stop.

### ⚠ Warning

The complete driver attention is always required while driving with adaptive cruise control. The driver stays fully in control of the vehicle because the brake pedal, the accelerator pedal and the button  have priority over any adaptive cruise control operation.

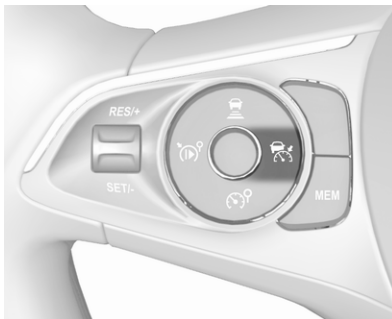
### Switching on the system



Press , the symbol  is indicated in the Driver Information Centre. The system is still not active.

### Activation of the functionality

#### Setting speed by the driver

The adaptive cruise control has to be switched on manually at a speed between **19 mph** and 112 mph. For vehicles with automatic transmission, the automatic selector lever must be in position **D** or **M**.

Accelerate to the desired speed and move the thumb wheel to **SET/-**. The current speed is stored and maintained.

The speed value is indicated in the Driver Information Centre.

The preset speed can then be changed by moving thumb wheel to **RES/+** to increase or **SET/-** to decrease the speed. Move thumb wheel repeatedly to change speed in small steps, move and hold to change speed in large steps.

When the adaptive cruise control is operating, the stop-start system is automatically deactivated.



### Adopting speed by the speed limit recognition

The intelligent speed adaptation informs the driver when a speed limit is detected by the speed limit recognition. The detected speed limit can be taken over as new set speed for the adaptive cruise control.

Using the camera at the top of the windscreen, this system detects and reads speed limit and end of speed limit signs.

If the adaptive cruise control is active, the recognised speed limit will be displayed in the Driver Information Centre and **MEM** illuminates.

Press **MEM** on the steering wheel to request saving of the suggested speed.

Press **MEM** on the steering wheel once more to confirm and save the new speed setting.

This speed limit is now the new set speed of the adaptive cruise control.

The function can be activated or deactivated in the personalisation menu ↪ 92.

### Overriding set speed

It is always possible to drive faster than the selected set speed by depressing the accelerator pedal. When the accelerator pedal is released, the vehicle returns to the stored speed. If a slower moving vehicle is ahead, the following distance selected by the driver is restored.

If the set speed is exceeded, the indicated speed setting flashes in the Driver Information Centre and a warning message appears.

#### Warning

Accelerating by the driver deactivates automatic braking by the system. This is indicated as a pop-up warning in the Driver Information Centre.

### Resuming stored speed

Move the thumb wheel to **RES/+** at a speed above 19 mph. The adaptive cruise control is activated with the stored set speed.

### Adaptive cruise control on vehicles with automatic transmission

For vehicles with automatic transmission, adaptive cruise control allows to maintain the selected distance behind a stopping vehicle until a complete stop is reached.

If the system has stopped your vehicle behind another vehicle, then the set speed is replaced by a green control indicator (A). This symbol notifies, that the vehicle is hold automatically in stop position.

If the stopped vehicle ahead was stopped for a longer time and then begins to move forward, the green illuminated vehicle ahead control indicator (A) will flash and a warning chime will sound as a reminder to check traffic before resuming.

When the vehicle ahead drives away, press the accelerator pedal until 19 mph and then move the thumb wheel to **SET-** or **RES+** to resume adaptive cruise control. If the vehicle stays stopped for more than 5 minutes or if the driver's door is

opened and the driver's seat belt is unfastened, then the electric parking brake is applied automatically to hold the vehicle. Control indicator (P) will illuminate. To release electric parking brake, press the accelerator pedal.

Electric parking brake ⇨ 138.

### ⚠ Warning

When the system is deactivated or cancelled, the vehicle will no longer be held at a stop and can start moving. Be always prepared to manually apply the brake to hold the vehicle stationary.

Do not leave the vehicle while it is being held at a stop by adaptive cruise control. Always move selector lever to park position P and switch off the ignition before leaving the vehicle.

### Setting the following distance

When adaptive cruise control detects a slower moving vehicle in the driving path, it will adjust the vehicle speed to maintain the following distance selected by the driver.

The following distance can be set to close (1 bar), normal (2 bars) or far (3 bars).

If the engine is running and the adaptive cruise control is enabled (grey), you can modify the following distance setting:

Press , the current setting is shown in the Driver Information Centre.



Press  again to change the following distance: The new setting is displayed in the Driver Information Centre.

The selected following distance is indicated by full bars in the adaptive cruise control page.

### ⚠ Warning

The driver accepts full responsibility for the appropriate following distance based on traffic, weather and visibility conditions. Following distance must be adjusted or the system switched off when required by the prevailing conditions.

### Detecting the vehicle ahead

If the system detects a vehicle in the driving path, the adaptive cruise control symbol displayed in the Driver Information Centre changes:  is changed to .

### Deactivation of the functionality

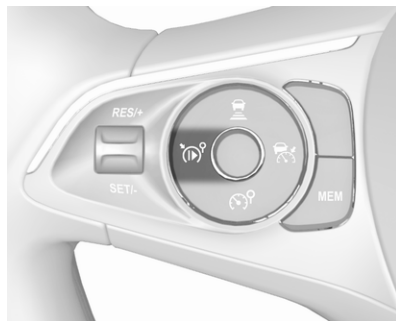

Press , the adaptive cruise control is in pause mode and a message is displayed. The vehicle is driven without adaptive cruise control.

The adaptive cruise control is deactivated, but not disabled. The last stored set speed remains in memory for later usage.

The adaptive cruise control is deactivated automatically when:

- The brake pedal is depressed.
- The vehicle accelerates above 112 mph or slows down below 19 mph.
- The electric parking brake is applied.
- The Traction Control system or Electronic Stability Control is deactivated or operating.
- The selector lever of automatic transmissions is neither in **D** nor in **M**.
- A fault is detected in the Electronic Stability Control or the radar system.

### Switching off the system

Press , the adaptive cruise control mode is disabled and the adaptive cruise control indication extinguishes in the Driver Information Centre.

Pressing  to activate the speed limiter deactivates adaptive cruise control.

Switching off the ignition deletes the stored set speed.

### Driver's attention

- Use the adaptive cruise control carefully on bends or mountain roads, as it can lose the vehicle ahead and needs time to detect it again.
- Do not use the system on slippery roads as it can create rapid changes in tyre traction (wheel spinning), so that you could lose control of the vehicle.
- Do not use the adaptive cruise control during rain, snow or heavy dirt, as the radar sensor can be covered by a water film, dust, ice or snow. This reduces or suppresses completely the visibility. In case of sensor blockage, clean the sensor cover.
- Do not use the system when the spare wheel is in use.

### System limits

#### Warning

The system's automatic brake force does not permit hard braking and the braking level may not be sufficient to avoid a collision.

- After a sudden lane change, the system needs a certain time to detect the next preceding vehicle. So if a new vehicle is detected, the system may accelerate instead of braking.
- The adaptive cruise control does ignore the oncoming traffic.
- The adaptive cruise control does not consider pedestrians and animals for braking and driving off.
- The adaptive cruise control considers stopped vehicles only at low speed.

- Do not use the adaptive cruise control when towing a trailer.
- Do not use the adaptive cruise control on roads with an incline of more than 10%.

As the radar's field of detection is quite narrow, it is possible that the system may not detect:

- vehicles of reduced width, e.g. motorcycles, scooters
- vehicles not running in the middle of the lane
- vehicles entering a corner
- vehicles suddenly pulling out

### Bends

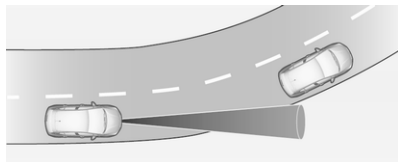

The adaptive cruise control calculates a predicted path based on the centrifugal force. This predicted path considers the current bend characteristic, but cannot consider a

future bend change. The system may lose the current vehicle ahead or consider a vehicle which is not in the actual lane. This can happen when entering or exiting a bend or if the bend gets stronger or weaker. If it no longer detects any vehicle ahead, then control indicator  will extinguish.

If the centrifugal force is too high in a bend, the system slows down the vehicle slightly. This braking level is not designed to avoid spinning-off the bend. The driver is responsible for reducing the selected speed before entering a bend and in general to adapt the speed to the road type and to existing speed limits.

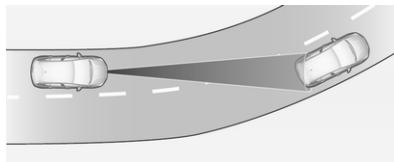

### Motorways

On motorways, adapt the set speed to the situation and the weather. Always consider that adaptive cruise

control has a limited visibility range, a limited braking level and a certain reaction time to verify if a vehicle is on the driving path or not. Adaptive cruise control may not be able to brake the vehicle in time to avoid a collision with a much slower vehicle or after a lane change. This is particularly true while driving fast or if the visibility is reduced due to weather conditions.

While entering or exiting a motorway, adaptive cruise control may lose the vehicle ahead and accelerate up to the set speed. For this reason, decrease the set speed before the exit or before the entry.

### Vehicle path changes

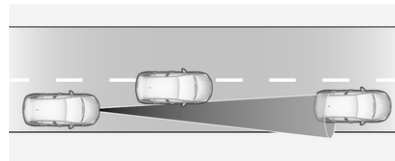

If another vehicle enters your driving path, adaptive cruise control will first consider the vehicle when it is completely in your path. Be ready to

take action and depress the brake pedal, if you need to brake more quickly.

### Hill considerations



#### **⚠ Warning**

Do not use the adaptive cruise control on steep hill roads.

System performance on hills depends on vehicle speed, vehicle load, traffic conditions and the road incline. It may not detect a vehicle in your path while driving on hills. On steep hills, you may have to use the accelerator pedal to maintain your vehicle speed. When going downhill you may have to brake to maintain or reduce your speed.

Note that applying the brake deactivates the system.

### Radar unit



The radar unit is located in the middle of the front bumper.

#### **⚠ Warning**

The radar unit was aligned carefully during manufacture. Therefore, in the event of a front-end impact, do not use the system. The front bumper may appear to be intact, however the sensor behind may be affected and react incorrectly. After an accident, consult a workshop to verify and adjust the radar unit position.

### Fault

In the event of a fault with the adaptive cruise control, you are alerted by the illumination of a warning light and the display of a message in the instrument panel, accompanied by an audible signal.

The adaptive cruise control may not operate correctly if traffic signs do not comply with the Vienna Convention on Road Signs and Signals.

Have the system checked by a dealer or a qualified workshop.

As a safety measure, do not use the system if the brake lights are faulty. Do not use the system if the front bumper is damaged.

### Forward collision alert

The forward collision alert may help to avoid or reduce the harm caused by front-end crashes.

The forward collision alert uses the front camera in the windscreen and a radar unit located behind the front bumper of the vehicle to detect a vehicle directly ahead, in your path.

If a vehicle directly ahead is approached too quickly, a warning chime and alert in the Driver Information Centre is provided.

**⚠ Warning**

Forward collision alert is just a warning system and does not apply the brakes. When approaching a vehicle ahead too rapidly, it may not provide you enough time to avoid a collision.

The driver accepts full responsibility for the appropriate following distance based on traffic, weather and visibility conditions.

The complete attention of the driver is always required while driving. The driver must always be ready to take action and apply the brakes.



**Activation**

If equipped only with front camera forward collision alert detects vehicles in forward gear in the range between walking speed and 53 mph.

With radar sensor and front camera forward collision alert detects vehicles in forward gear in the range between walking speed and 87 mph.

**Alerting the driver**

The driver is warned by following alerts:

- Symbol  and a warning message are displayed in the Driver Information Center, when the distance to the vehicle ahead gets too small.
- Symbol  and a warning message are displayed in the Driver Information Center and a warning chime sounds, when a collision is imminent and immediate driver's action is required.

**⚠ Warning**

Forward collision alert is just a warning system and does not apply the brakes. When

approaching a vehicle ahead too rapidly, it may not provide you enough time to avoid a collision.

The driver accepts full responsibility for the appropriate following distance based on traffic, weather and visibility conditions.

The complete attention of the driver is always required while driving. The driver must always be ready to take action and apply the brakes.

**Caution**

The colour lighting of this control indicator does not correspond to local traffic laws on following distance. The driver bears full responsibility for maintaining safe following distance according to applicable traffic rules, weather and road conditions etc. at all times.

**Selecting the alert sensitivity**

Adjust the alert sensitivity in the Info Display ⇨ 88.

The chosen setting will remain until it is changed. The alert timing will vary based on vehicle speed. The faster the vehicle speed, the farther away the alert will occur. Consider traffic and weather conditions when selecting the alert timing.

### Deactivation

The system can only be deactivated by deactivating the active emergency braking in the Info Display ↷ 88.

### System limitations

Forward collision alert is designed to warn on vehicles, but may react also to other objects.

In the following cases, forward collision alert may not detect a vehicle ahead or sensor performance is limited:

- driving on winding or hilly roads
- driving during nighttime
- weather limits visibility, such as fog, rain, or snow

- the sensor in the windscreen or the radar unit behind the front bumper are blocked by snow, ice, slush, mud, dirt etc.
- the windscreen is damaged or affected by foreign objects, e.g. stickers

### Active emergency braking

Active emergency braking can help to reduce the damage and injury from crashes with vehicles, pedestrians and obstacles directly ahead, when a collision can no longer be avoided either by manual braking or by steering. Before the active emergency braking applies, the driver is warned by the forward collision alert or the front pedestrian protection alert.

Forward collision alert ↷ 155

Front pedestrian protection ↷ 159

Active emergency braking can be deactivated in the Info Display ↷ 88. If deactivated,  illuminates in the Driver Information Centre and a warning message is displayed in the Driver Information Centre.

The feature uses various inputs (e.g. camera sensor, radar sensor, brake pressure, vehicle speed) to calculate the probability of a frontal collision.

### Warning

This system is not intended to replace the driver responsibility for driving the vehicle and looking ahead. Its function is limited to supplemental use only to reduce the vehicle speed before a collision.

The system may not react to animals. After a sudden lane change, the system needs a certain time to detect the next preceding vehicle.

The driver must always be ready to take action and apply the brakes and steer to avoid collisions.

### Functionality

If equipped only with front camera the active emergency braking operates in forward gear in the range between 3 mph and 53 mph. With radar sensor and front camera active emergency

braking operates in forward gear in the range between 3 mph and 87 mph.

A precondition is that the system is not deactivated in the Info Display and the seat belts of the front passengers are fastened ⇨ 88.

The system includes:

- brake preparation system
- emergency automatic braking
- intelligent brake assist
- forward collision alert
- front pedestrian protection

### Brake preparation system

When approaching a vehicle ahead or a pedestrian so quickly that a collision is likely, the brake preparation system slightly pressurises the brakes. This reduces the response time, when braking is requested.

### Emergency automatic braking

After activation of brake preparation system and just before the imminent collision, this function automatically

applies limited braking to reduce the impact speed of the collision or prohibit a crash. If active emergency braking is applied, (E) flashes in the Driver Information Centre. Front automatic braking can only occur if a vehicle ahead is detected. On vehicles with front pedestrian protection, front automatic braking can also occur when a pedestrian ahead is detected.

Forward collision alert ⇨ 155

Front pedestrian protection ⇨ 159

Emergency automatic braking may slow the vehicle to a complete stop to try to avoid a potential crash. If this happens, emergency automatic braking may engage the electric parking brake to hold the vehicle at a stop. To release press the electric parking brake button or firmly press the accelerator pedal.

#### Warning

Emergency automatic braking is an emergency crash preparation feature and is not designed to

avoid crashes. Do not rely on the system to brake the vehicle. Emergency automatic braking will not brake outside of its operating speed range and only responds to detected vehicles and pedestrians.

### Intelligent brake assist

Intelligent brake assist provides a boost to braking when the brake pedal is quickly applied. The braking is based on the speed of approach and distance to a vehicle ahead.

Minor brake pedal pulsations or pedal movement during this time is normal and the brake pedal should continue to be applied as needed. Intelligent brake assist will automatically disengage only when the brake pedal is released.

#### Warning

Intelligent brake assist may increase vehicle braking in situations when it may not be necessary. You could block the



flow of traffic. If this occurs, take your foot off the brake pedal and then apply the brakes as needed.

Forward collision alert ⇨ 155.

Front pedestrian protection ⇨ 159.

### System limitations

In some cases, the active emergency braking system may provide an automatic braking in situations that seem to be unnecessary, for instance in parking garages, due to various types of objects such as traffic signs or due to vehicles in another lane. This is normal operation, the vehicle does not need service. Firmly apply the accelerator pedal to override the automatic braking if the situation and the surroundings permit.

In the following cases, active emergency braking performance might be limited:

- driving on winding or hilly roads
- detecting all vehicles, especially vehicles with a trailer, tractors, muddy vehicles, etc.

- weather limits visibility, such as fog, rain, or snow
- driving during nighttime
- the sensor in the windscreen or the radar unit behind the front bumper are blocked by snow, ice, slush, mud, dirt etc.
- the windscreen is damaged or affected by foreign objects, e.g. stickers

Complete attention is always required while driving, and you should be ready to take action and apply the brakes and / or steer the vehicle to avoid crashes.

We recommend to deactivate the system in the Info Display in the following cases:

- when towing a trailer or caravan
- when carrying long objects on roof bars or a roof rack
- when the vehicle is being towed with the engine running
- when a spare wheel is fitted that is smaller than the other wheels
- before using an automatic car wash with the engine running

- before placing the vehicle on a rolling road in a workshop
- if the windscreen has been damaged close to the camera
- if the front bumper has been damaged
- if the brake lights are not working

### Fault

In case the system requires a service, a message is displayed in the Driver Information Centre.

If the system does not work as it should do, vehicle messages are displayed in the Driver Information Centre.

Vehicle messages ⇨ 91.

### Front pedestrian protection

Front pedestrian protection may help to avoid or reduce the harm caused by front-end crashes with pedestrians when driving forward.

The system uses the front camera in the windscreen and a radar unit in the front bumper to detect a pedestrian directly ahead in your path.

Front pedestrian protection can detect and alert to pedestrians in a forward gear at speeds between 3 mph and 37 mph. Additionally front pedestrian protection can provide a boost to braking or automatically brake the vehicle.

During nighttime driving, system performance is limited.

**⚠ Danger**

Front pedestrian braking does not provide an alert or automatically brake the vehicle, unless it detects a pedestrian.

The system may not detect pedestrians, including children, when the pedestrian is not directly ahead, not fully visible, not standing upright, or when part of a group.

Front pedestrian protection includes:

- detecting front pedestrian ahead
- front pedestrian alert

Front pedestrian protection is activated together with forward collision alert.

Forward collision alert ⇨ 155.

### Front pedestrian alert

When approaching a detected pedestrian too quickly, a warning message is displayed in the Driver Information Centre. A warning chime is provided.

Cruise control or adaptive cruise control may be disengaged when the front pedestrian alert occurs.

### System limitations

In the following cases, front pedestrian protection may not detect a pedestrian ahead or sensor performance is limited:

- vehicle speed is out of range from 3 mph to 37 mph in forward gear
- driving on winding or hilly roads
- driving during nighttime
- weather limits visibility, such as fog, rain, or snow

- the sensor in the windscreen or the radar unit behind the front bumper are blocked by snow, ice, slush, mud, dirt etc.
- the windscreen is damaged or affected by foreign objects, e.g. stickers

## Parking assist

### General information

When attaching a trailer or bicycle carrier to the trailer hitch, the parking assist is deactivated.

**⚠ Warning**

The driver bears full responsibility for the parking manoeuvre.

Always check the surrounding area when driving backwards or forwards while using parking assist system.

### Rear parking assist

The system warns the driver with acoustic signals and display indication against potentially

hazardous obstacles behind the vehicle in a distance range up to 50 cm while reverse gear is engaged.

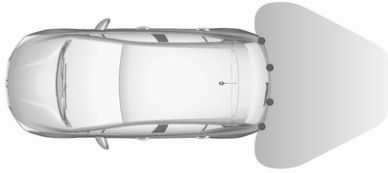

The system operates with ultrasonic parking sensors in the rear bumper.

### Activation



Rear parking assist is activated when reverse gear is engaged and ignition is switched on.

The system is ready to operate when the LED in the parking assist button  is not illuminated.

### Indication

Depending on which side of the vehicle is closer to an obstacle, you will hear acoustic warning signals in the vehicle on the respective side. The interval between the sounds becomes shorter as the vehicle gets closer to that obstacle. When the distance is less than approx. 30 cm, the sound is continuous.



Additionally, the distance to rear obstacles is displayed by changing distance lines in the Info Display  88. When the obstacle is very close,  for danger is displayed.

### Deactivation



The system is switched off when reverse gear is disengaged. Press  to deactivate the system manually. The LED in the button illuminates when the system is deactivated. If the system has been deactivated manually, it is not reactivated automatically the next time the ignition is switched on.

### Front-rear parking assist

The front-rear parking assist measures the distance between the vehicle and obstacles in front and

behind the vehicle. It informs and warns the driver by giving acoustic signals and display indication.

It uses two different acoustic warning signals for the front and rear monitoring areas, each with a different tone frequency.

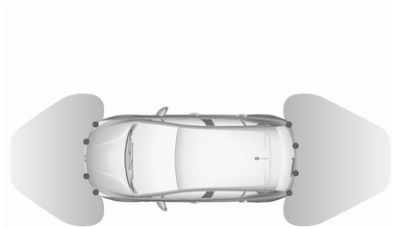

The system operates with ultrasonic parking sensors in the rear and front bumper.

### Activation

In addition to the rear parking assist, the front parking assist is triggered when an obstacle is detected in front and the speed of the vehicle is below 6 mph.



The system is ready to operate when the LED in the parking assist button **P OFF** is not illuminated.

When the system is deactivated, the LED in the button illuminates.

### Indication

The system warns the driver with acoustic signals against potentially hazardous obstacles in front of the vehicle and behind the vehicle.

Depending on which side of the vehicle is closer to an obstacle, you will hear acoustic warning signals in the vehicle on the respective side.

The interval between the sounds becomes shorter as the vehicle gets

closer to that obstacle. When the distance is less than approx. 30 cm, the sound is continuous.

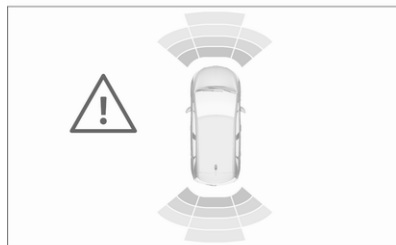

Additionally, the distance to rear and front obstacles is displayed by changing distance lines in the Info Display ↷ 88.

If the vehicle stops for more than 3 seconds in a forward gear, if automatic transmission is in **P** or if no further obstacles are detected, no acoustic warning signals are given.

### Deactivation

The system is deactivated automatically when vehicle speed exceeds 6 mph, by applying the electric parking brake or by pressing the parking assist button  .

When the system is deactivated manually, the LED in the button illuminates.

If the system has been deactivated manually, it is not reactivated automatically the next time the ignition is switched on.

### System limitations

In the event of a fault or if the system does not work temporarily, e.g. because of high external noise level or other interference factors,  illuminates in the Driver Information Centre. A message is displayed.

#### Warning

Under certain circumstances, various reflective surfaces on objects or clothing as well as

external noise sources may cause the system to fail to detect obstacles.

Special attention must be paid to low obstacles which can damage the lower part of the bumper.

#### Caution

Performance of the system can be reduced when sensors are covered, e.g. by ice or snow.

Performance of the parking assist system can be reduced due to heavy loading.

Special conditions apply if there are taller vehicles in the vicinity (e.g. off-road vehicles, mini vans, vans). Object identification and correct distance indication in the upper part of these vehicles cannot be guaranteed.

Objects with a very small reflection cross-section, e.g. objects of narrow size or soft materials, may not be detected by the system.

Parking assist systems do not detect objects outside the detection range.

### Advanced parking assist

#### Warning

The driver bears full responsibility for accepting the parking slot suggested by the system and the parking manoeuvre.

Always check the surrounding area in all directions when using the advanced parking assist.

The advanced parking assist measures a suitable parking slot while passing, calculates the trajectory and automatically steers the vehicle while parking.

Advanced parking assist provides assistance for the following manoeuvres:

- entry into a parallel parking slot
- entry into a perpendicular parking slot
- exit from a parallel parking slot

The driver must control acceleration, braking and gear shifting, while steering is done automatically. The driver can take control at any time by gripping the steering wheel.

It may be necessary to move forwards and backwards more than once.

Instructions are given in the Info Display ↻ 88.

Advanced parking assist can only be activated when driving forwards.

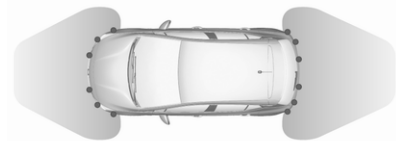

Advanced parking assist is always combined with front-rear parking assist.

The system has six ultrasonic parking sensors each in both the rear and front bumper.

### Entry into a parallel parking slot

#### Activation

Slow down the vehicle speed below 12 mph.

To search for a parking slot, activate the system in the Info Display ↻ 88.

Select the parallel parking slot menu.

Select parking side by switching on the turn light on the respective side.

The allowed parallel distance between the vehicle and a row of parked cars is between 0.5 m and 1.5 m.

The system will not identify slots that are clearly smaller or larger than the vehicle.

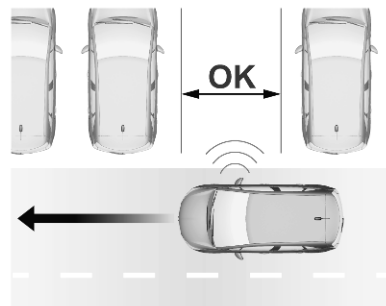

When a free slot is detected, a visual feedback on the Info Display and a first acoustic signal are given. Drive slowly forwards. When the second acoustic signal is given, stop the vehicle, select reverse gear, release the steering wheel and start moving slowly. A visual feedback is given on the Info Display.

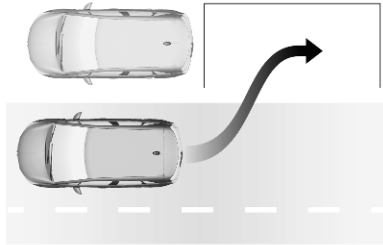

Move forwards and backwards while observing the warnings of the parking assist until the end of manoeuvre is indicated.

### Entry into a perpendicular parking slot

#### Activation

Slow down the vehicle speed below 12 mph.

To search for a parking slot, activate the system in the Info Display ↻ 88.

Select the perpendicular parking slot menu.

Select parking side by switching on the turn light on the respective side.

The allowed parallel distance between the vehicle and a row of parked cars is between 0.5 m and 1.5 m.

When several successive slots are found, the vehicle will be directed towards the last one.

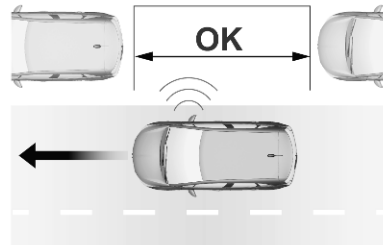

When a free slot is detected, a visual feedback on the Info Display and an acoustic signal are given. Stop the vehicle, select reverse gear, release the steering wheel and start moving without exceeding 4 mph.

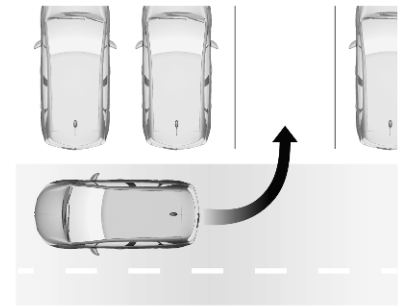

Move forwards and backwards as instructed by observing the warnings of the parking assist and paying attention to the acoustic signals until the end of manoeuvre is indicated.

During the parking manoeuvre, the system is automatically deactivated once the rear of the vehicle is within 50 cm of an obstacle.

### Exiting a parallel parking slot

#### Activation

When exiting a parallel parking slot, activate the system in the Info Display ↻ 88.

Select the exiting a parallel parking slot menu.

Select exit side by switching on the respective turn light.

Engage reverse or forward gear, release the steering wheel and start moving without exceeding 3 mph.

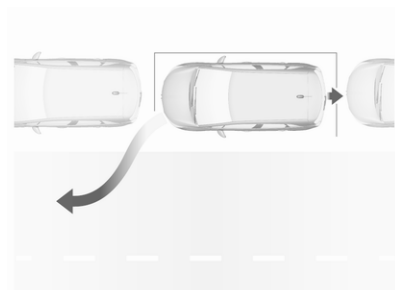

Move forwards and backwards while observing the warnings of the Parking assist until the end of manoeuvre is indicated. The manoeuvre is complete when the vehicle's front wheels are out of the parking slot.

After deactivation check control over the vehicle.

### Display indication

The instructions on the display show:

- general hints and warning messages
- the demand to stop the vehicle, when a parking slot is detected
- the direction of driving during the parking manoeuvre
- the demand to shift into reverse or first gear
- the demand to stop or to drive slowly
- the successful completion of the parking manoeuvre indicated by a pop-up symbol and a chime
- the cancelling of a parking manoeuvre

### Deactivation

The current park assist manoeuvre is cancelled via the button to return to the previous screen in the Info Display. To deactivate the system completely, press **PA** OFF in the centre console.

The system is deactivated automatically:

- if the ignition is switched off
- if stalling the engine
- if no manoeuvre is started within 5 minutes of selection of the type of manoeuvre
- after a prolonged stop of the vehicle during a manoeuvre
- if the Electronic Stability Control is triggered
- if the speed of the vehicle exceeds the stated limit
- when the driver interrupts movement of the steering wheel
- after four manoeuvre cycles (a manoeuvre cycle consists of one rear move and one forward move)
- on opening the driver's door
- if one of the front wheels encounters an obstacle
- parking manoeuvre successfully ended



Deactivation by the driver or by the system during manoeuvring will be indicated on the display. Additionally, an acoustic signal sounds.

The system is switched off automatically when towing an electrically connected trailer, bicycle carrier, etc.

Contact your dealer to switch off the system for a prolonged period.

### Fault

In the event of a fault, a message is displayed in the Info Display, accompanied by an acoustic signal.

In the event of a fault in the power steering,  illuminates and a message is displayed in the Driver Information Centre.

### Warning

Under certain circumstances, various reflective surfaces on objects or clothing as well as external noise sources may cause the system to fail to detect obstacles.

Special attention must be paid to low obstacles which can damage the lower part of the bumper.

### Caution

Performance of the system can be reduced when sensors are covered, e.g. by ice or snow.

Performance of the parking assist system can be reduced due to heavy loading.

Special conditions apply if there are taller vehicles in the vicinity (e.g. off-road vehicles, mini vans, vans). Object identification and correct distance indication in the upper part of these vehicles cannot be guaranteed.

Objects with a very small reflection cross-section, e.g. objects of narrow size or soft materials, may not be detected by the system.

Parking assist systems do not detect objects outside the detection range.

### Notice

It is possible that the sensor detects a non-existing object caused by echo disturbance from external acoustic noise or mechanical misalignments (sporadic false warnings may occur).

Make sure that the front number plate is properly mounted (not bent and no gaps to the bumper on the left or right side) and the sensors are firmly in place.

Advanced parking assist system may not respond to changes in the available parking space after initiating a parking manoeuvre. The system may recognize an entry, a gateway, a courtyard or even a crossing as a parking slot. After selecting reverse gear the system will start a parking manoeuvre. Take care regarding the availability of the suggested parking slot.

Surface irregularities, e.g. on construction zones, are not detected by the system. The driver accepts responsibility.

## Side blind spot alert

The side blind spot alert system detects and reports objects on either side of the vehicle, within a specified blind spot zone. The system displays a visual alert in each exterior mirror, when detecting objects that may not be visible in the interior and exterior mirrors.

Side blind spot alert uses some of the advanced parking assist sensors which are located in the front and rear bumper on both sides of the vehicle.

### ⚠ Warning

Side blind spot alert does not replace driver vision.

The system does not detect:

- vehicles outside the side blind zones which may be rapidly approaching
- pedestrians, cyclists or animals

Before changing a lane, always check all mirrors, look over the shoulder and use the turn light.

## Activation

Activate the side blind spot alert in the Info Display ⇨ 88.

<sup>a18</sup> illuminates continuously green in the Driver Information Centre to confirm the function.

## Functionality

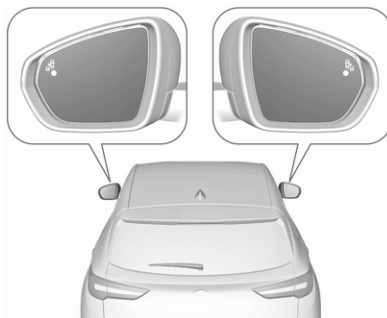

When the system detects a vehicle in the side blind zone while driving forwards, an LED will illuminate in the relevant exterior mirror.

The LED comes on immediately when being passed.

The LED comes on after a delay when passing another vehicle slowly.

## Operation conditions

The following conditions must be fulfilled for proper operation:

- all vehicles are moving in the same direction and in adjacent lanes
- the speed of your vehicle is between 7 and 87 mph
- passing a vehicle with a speed difference of less than 6 mph
- another vehicle is passing with a speed difference of less than 15 mph
- the traffic flow is normal
- driving on a straight or slightly curved road
- the vehicle is not pulling a trailer

No alert will be given in the following situations:

- in the presence of non-moving objects, e.g. parked vehicles, barriers, street lamps, road signs
- in very dense traffic, when moving vehicles might be confused with a stationary object
- with vehicles moving in the opposite direction
- driving on a winding road or a sharp corner
- when passing or being passed by a very long vehicle, e.g. lorry, coach, which is at the same time detected at the rear in the blind spot angle and present in the driver's forward field of vision
- when passing too quickly

### Deactivation



The system is deactivated in the Info Display ↗ 88.  extinguishes in the Driver Information Centre. Additionally, an acoustic signal sounds.

The state of the system is stored when switching off the ignition.

The system is automatically deactivated when towing an electrically connected trailer.

Due to adverse weather conditions such as heavy rain, false detections may occur.

### Fault

In the event of a fault,  flashes for a few moments in the instrument panel, accompanied by  and a display message. Contact a dealer or a qualified workshop to have the system checked.

### Night vision

Night vision warns the driver about pedestrians and animals in his visual field during the night. The system uses an infrared camera  below the bonnet.



### Activation

Night vision is activated in the Info Display ↗ 88. If the operation conditions are met,  illuminates in green. The system is active.

To display the image provided by the camera in the Driver Information Centre, select night vision using the adjuster wheel of the indicator lever.

### Functionality

Detected pedestrians or animals are displayed within a yellow frame. The warmer the temperature of the object the brighter the colour in which it is displayed.



If a collision is imminent, the object detected is displayed in a red frame and an alert symbol is triggered.



If night vision is activated but its permanent display is not selected, a temporary window including the alert symbol is displayed in case of an imminent collision.

### Operation conditions

The following conditions must be fulfilled for proper operation:

- light conditions are poor
- low beam is activated
- outside temperature is between  $-30\text{ }^{\circ}\text{C}$  and  $30\text{ }^{\circ}\text{C}$
- vehicle speed must be below 99 mph
- distance to the object to be detected is between 15 m (for pedestrians) and 200 m depending on light conditions
- animals and pedestrians taller than 0.5 m

### System limits



In the following cases, night vision may not work:

- weather limits visibility such as fog, rain or snow
- camera covered by snow, mud, dirt etc.
- driving on winding or hilly roads
- driving through a bend

### Warning

In the event of a front impact, the infrared camera may be affected and not work properly. After an accident, consult a workshop to verify and adjust the position of the infrared camera.

### Deactivation

The system is deactivated in the Info Display  88.  extinguishes in the Driver Information Centre.

The state of the system is not stored when switching off the ignition.

The system is automatically deactivated when the operating conditions are not met.

### Fault

In the event of a fault,  illuminates in the Driver Information centre, accompanied by a message. Contact a dealer or a qualified workshop to have the system checked.

## Panoramic view system

This system allows views of the vehicle's surroundings to be displayed as a nearly 360° picture in the Info Display, like a bird's eye view.

The system uses:

- rear camera, installed in the tailgate
- ultrasonic parking sensors in the rear bumper
- front camera, installed in the front grill below the emblem
- ultrasonic parking sensors in the front bumper

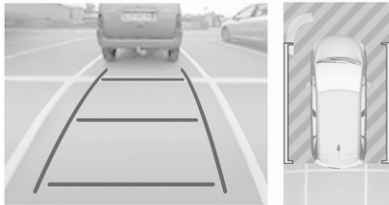

The screen in the Info Display is divided into two parts. On the right there is a view from above the vehicle and on the left there is the view from the rear or the front displayed. The parking sensors complete the information on the view from above the vehicle.

### Activation

The panoramic view system is activated by:

- engaging a gear or gearbox in a neutral position (front view)
- engaging reverse gear (rear view)
- manual activation in the Info Display when driving not more than 12 mph

### Functionality

Different views can be selected in the left part of the display. Change the type of view at any time during a manoeuvre by pressing the touch field in the left lower zone of the display and selecting a view from the view selection menu:

- Standard view
- Auto mode
- Zoom view
- 180° view

The display is immediately updated with the type of view selected.

Auto mode is activated by default. In this mode, the system selects the best view, standard, or zoom, to display according to the information from the parking sensors.

The state of the system is not kept in memory when the ignition is switched off.

### Standard view

The standard view consists of a rear view and a front view.

**Rear view**

The area behind the vehicle is displayed in the screen. The vertical lines represent the width of the vehicle with mirrors unfolded. The direction of the lines changes with the position of the steering wheel.

The first horizontal line represents a distance of about 30 cm beyond the edge of vehicle's rear bumper. The upper horizontal lines represent distances of about 1 m and 2 m.

This view is available in auto mode or in the view selection menu.

**Front view**

The area in front the vehicle is displayed in the screen. The vertical lines represent the width of the vehicle with mirrors unfolded. The direction of the lines changes with the position of the steering wheel.

The first horizontal line represents a distance of about 30 cm beyond the edge of vehicle's front bumper. The upper horizontal lines represent distances of about 1 m and 2 m.

This view is available in auto mode or in the view selection menu.

**Auto mode**

This mode is activated by default. Using sensors in the rear or in the front bumper, the automatic view changes from rear view or front view to a view from above, as an obstacle is approached during a manoeuvre.

**Zoom view**

The camera records the vehicle's surroundings during the manoeuvre in order to reconstruct a view from above the rear or the front of the vehicle in its near surroundings. Thus, the vehicle can be manoeuvred around obstacles nearby. This view is available with auto mode or in the view selection menu.

## 180° view



The 180° view facilitates reversing out of a parking bay, making it possible to see the approach of vehicles, pedestrians and cyclists. This view is not recommended for carrying out a complete manoeuvre. It is made up of three areas: left 1, centre 2 and right 3. This view is available from the view selection menu only.

## Deactivation

Panoramic view system is deactivated when:

- driving faster than 12 mph
- 7 seconds after disengaging reverse gear
- by pressing the icon ⊗ in the left upper corner of the touch screen
- opening the tailgate

## General information

### ⚠ Warning

The panoramic view system does not replace driver vision. It will not display children, pedestrians, cyclists, crossing traffic, animals, or any other objects outside of the camera view area, e. g. below the bumper, or underneath the vehicle.

Do not drive or park the vehicle using only the panoramic view system.

Always check the surrounding of the vehicle before driving.

Displayed images may be further or closer than they appear. The area displayed is limited and objects that are close to either edge of the bumper or under the bumper are not displayed on the screen.

## System limitations

### Caution

For optimal operation of the system, it is important to keep the lense of the camera in the tailgate between the number plate lights and the lense in the front grill below the emblem always clean. Rinse the lenses with water and wipe with a soft cloth.

Do not clean the lenses with a steam-jet or high-pressure jet cleaner.

The panoramic view system may not operate properly when:

- The surrounding is dark.
- The sun or the beam of headlights is shining directly into the camera lenses.
- Weather limits visibility, such as fog, rain, or snow.
- The camera lenses are blocked by snow, ice, slush, mud, dirt.
- The vehicle is towing a trailer.
- The vehicle had an accident.
- There are extreme temperature changes.

## Rear view camera

The rear view camera assists the driver when reversing by displaying a view of the area behind the vehicle.

The view of the camera is displayed in the Info Display.

### ⚠ Warning

The rear view camera does not replace driver vision. Note that objects that are outside the camera's field of view and the parking assist sensors, e.g. below the bumper or underneath the vehicle, are not displayed.

Do not reverse or park the vehicle using only the rear view camera.

Always check the surrounding of the vehicle before driving.

### Switching on

Rear view camera is automatically activated when reverse gear is engaged.

### Functionality

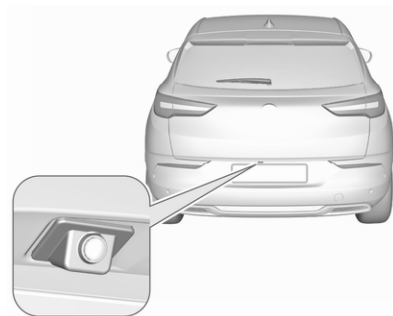

The camera is mounted in the tailgate.

The area displayed by the camera is limited. The distance of the image that appears on the display differs from the actual distance.

### Guidelines

Dynamic guidelines are horizontal lines at 1 m intervals projected onto the picture to define the distance to displayed objects.



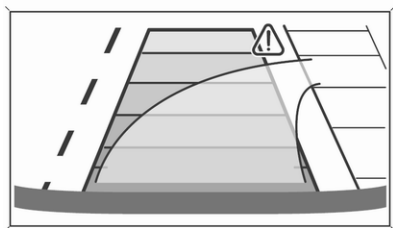

Trajectory lane of the vehicle is shown in accordance with the steering angle.

### Switching off

The camera is switched off when a forward gear is engaged.

### System limitations

The rear view camera may not operate properly when:

- the surrounding is dark
- the beam of headlights is shining directly into the camera lenses
- weather limits visibility, such as fog, rain, or snow

- the camera lenses are blocked by snow, ice, slush, mud, dirt. Clean the lense, rinse with water, and wipe with a soft cloth
- the tailgate will be opened
- the vehicle is towing an electrically connected trailer, bicycle carrier, etc.
- the vehicle had a rear end accident
- there are extreme temperature changes

### Traffic sign assistant

The traffic sign assistant is an extension of the speed limit recognition available for speed limiter and cruise control.



The system recognises the traffic signs above and displays them in the Driver Information Centre.

### Warning

The actual traffic sign always takes priority over the traffic sign displayed in the Driver Information Centre.

Speed limiter ⇨ 147.

Cruise control ⇨ 145.

Adaptive cruise control ⇨ 149.

Driver Information Centre ⇨ 87.

### Lane departure warning



The lane departure warning system observes the lane markings between which the vehicle is driving via a front camera located at the top of the windscreen. The system warns the driver in the event of an unintended lane departure via visual and acoustic signals.

There is no lane departure warning when the turn lights are operated and during 20 seconds after turn lights have been switched off.

**Warning**

This system is a driving aid that cannot, in any circumstances, replace the need for vigilance on the part of the driver.



**Activation**

After ignition is switched on, the lane departure warning system is activated. If the system is activated, the LED in the button  is not illuminated. To activate the system when the system is deactivated, press .

The system is only operable at vehicle speeds above 37 mph and if lane markings are available.

When the system recognises an unintended lane departure, the control indicator  flashes yellow. Simultaneously a chime sound is activated.

**Deactivation**

To deactivate the system, press and hold . The LED in the button is illuminated and  illuminates yellow in the Driver Information Centre.

At speeds below 37 mph the system is inoperable.

**Fault**

In the event of a fault,  appears in the instrument panel, accompanied by a display message and a warning chime. Contact a dealer or a qualified workshop to have the system checked.

**System limitations**

The system performance may not operate properly when:

- Vehicle speed is below 37 mph.
- Windscreen is not clean or affected by foreign objects, e.g. stickers.
- Driving on winding or hilly roads.
- During nighttime driving.
- Adverse environmental conditions like heavy rain, snow, direct sunlight or shadows.
- The sensor in the windscreen is blocked by snow, ice, slush, mud, dirt, windscreen damage or affected by foreign objects, e.g. stickers.
- The sun is shining directly into the camera lens.

- Close vehicles ahead.
- Driving on banked roads.
- Driving on road edges.
- Driving on roads with poor lane markings.
- Sudden lighting changes.

The system can not operate when no lane marking is detected.

## Lane keep assist

Lane keep assist helps to avoid unintentional lane departures. The front camera observes the lane markings between which the vehicle is driving. If the vehicle approaches a lane marking, the steering wheel is gently turned to position the vehicle back into the lane. The driver will then notice a turning movement of the steering wheel. Turn steering wheel in same direction, if system steers not sufficient. Turn steering wheel gently into opposite direction, if lane change is intended.

When the system steers to correct the trajectory of the vehicle,  flashes yellow in the Driver Information Centre.

A warning message in the Driver Information Centre accompanied by a warning chime alerts the driver when immediate driver's action is required.

Unintended lane departure is not assumed by the system when the turn lights are operated and during 20 seconds after turn lights have been switched off.

### Notice

The system may be switched off if it detects lanes which are too narrow, too wide or too curved.



Following preconditions have to be fulfilled:

- vehicle speed must be between 40 mph and 112 mph
- the driver must hold the steering wheel with both hands
- the change of trajectory is not accompanied by operation of the turn lights

- the Electronic Stability Control is activated and not in operation
- the vehicle is not connected to a trailer or an electric bicycle carrier
- normal driving behaviour (system detects dynamic driving style, i.e. pressure on the brake or accelerator pedal)
- roads with poor lane markings
- no spare wheel is used
- the driver needs to be active during the correction
- the vehicle is not driven in a tight corner

## Activation



If the system is activated, the LED in the button  is not illuminated. To activate the system when the system is deactivated, press .

The system is operational at vehicle speeds between 40 mph and 112 mph and if lane markings are detectable. The driver must hold the steering wheel with both hands. The Electronic Stability Control system must be activated.

The control indicator  flashes yellow during trajectory correction.

If the driver wishes to maintain the trajectory of the vehicle, he can prevent the correction by keeping a firm grip on the steering wheel, e.g. during an avoiding manoeuvre. The correction is interrupted if the turn lights are operated.

There is no correction triggered when the turn lights are operated and during 20 seconds after turn lights have been switched off.



If the system detects that the driver is not holding the steering wheel firmly enough during an automatic correction of trajectory, it interrupts

the correction. A warning message in the Driver Information Centre accompanied by a warning chime alerts the driver when immediate driver's action is required.

### Deactivation

To deactivate the system, press and hold . Deactivation of the system is confirmed by the illuminated LED in the button. In the Driver Information Centre solid grey lines are displayed.

### Fault

In the event of a fault,  and  appear in the instrument panel, accompanied by a display message and a warning chime. Contact a dealer or a qualified workshop to have the system checked.

### System limitations

The system performance may be affected by:

- windscreen not clean or affected by foreign objects, e.g. stickers
- close vehicles ahead
- banked roads

- winding or hilly roads
- road edges
- sudden lighting changes
- adverse environmental conditions, e.g. heavy rain or snow
- vehicle modifications, e.g. tyres

Switch off the system if the system is disturbed by tar marks, shadows, road cracks, temporary or construction lane markings, or other road imperfections.

### Warning

Always keep your attention on the road and maintain proper vehicle position within the lane, otherwise vehicle damage, injury or death could occur.

Lane keep assist does not continuously steer the vehicle.

The system may not keep the vehicle in the lane or give an alert, even if a lane marking is detected.

The steering of the lane keep assist may not be sufficient to avoid a lane departure.

The system may not detect hands-off driving due to external influences like road condition and surface and weather. The driver has full responsibility to control the vehicle and is always required to keep the hands on the steering wheel while driving.

Using the system while towing a trailer or on slippery roads could cause loss of control of the vehicle and a crash. Switch the system off.

## Advanced lane keep assist

### Warning

The system assists the driver in managing the steering, acceleration and braking within the limits of the laws of physics and the capabilities of the vehicle. Some road infrastructure elements or vehicles present on the road may not be properly seen

or may be poorly interpreted by the camera and radar, which may lead to an unexpected change in direction, a lack of steering correction and/or inappropriate management of the acceleration or braking.

Advanced lane keep assist is an enhancement of the lane keep assist system.



The activated system observes the lane markings by using the camera located at the top of the windscreen. It steers the vehicle inside the

detected lane. The driver will notice a turning movement of the steering wheel.

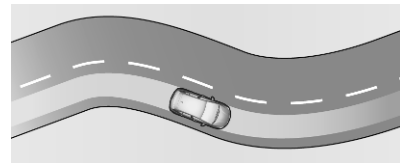

Thus, the current position of the vehicle within the lane is kept. This position is not necessarily the centre of the lane.

In the case that the vehicle is driving at the outer edge of the lane, the system corrects the trajectory smoothly towards the centre of the currently driven lane when a determined speed has been exceeded. Again, the driver will notice a turning movement of the steering wheel.

When the vehicle is steered by the system,  illuminates green in the Driver Information Centre.

However, the control of the vehicle can be taken over at any time by the driver. Therefore, the driver needs to apply some additional force when turning the steering wheel.

If the system detects that the driver is not holding the wheel firmly enough, it triggers a series of gradual alerts. If the interruption takes too long, the system will be deactivated.  extinguishes in the Driver Information Centre. The system has to be reactivated again by the driver.

Advanced lane keep assist operates only in combination with adaptive cruise control.

Adaptive cruise control  149.



### Required preconditions

- Adaptive cruise control must be activated.
- The driver must hold the steering wheel.
- The turn lights are not activated.
- The Electronic Stability Control is activated and not in operation.
- The vehicle is not connected to a trailer or a bicycle carrier.



- Normal driving behaviour is required (system detects dynamic driving style, i.e. pressure on the brake or accelerator pedal).
- Roads with good lane markings are required.
- No spare wheel is used.
- The vehicle is not driven in a tight corner.

### Activation



Press  to activate the system. The LED in the button is illuminated and  illuminates green in the Driver Information Centre if lane markings are detected. The system is active now.

### Deactivation

To deactivate the system, press . The LED in the button and  in the instrument panel are extinguished to confirm the deactivation of the system.



### Pausing / suspending the system

Advanced lane keep assist may be paused or suspended in the following situations:

- The Electronic Stability Control is in operation or it has been deactivated.
- At least one of the lane markings is not detected by the system for several seconds. The system will be reactivated once the operating conditions are regained.
- The turn lights are activated.
- Driving outside the lane limits.

- The steering wheel is held too tight or moved too dynamically.
- The brake pedal or the accelerator pedal are applied.
- The adaptive cruise control is paused.
- The road is too narrow or wide.
- The lateral acceleration in curves is too high

## Fault

In the event of a fault,  and  appear in the instrument panel, accompanied by a display message and a warning chime. Seek the assistance of a workshop.

## System limitations

The system performance may be affected by:

- a dirty or foggy windscreen or if the windscreen is affected by foreign objects, e.g. stickers
- close vehicles ahead
- banked roads
- winding or hilly roads
- road edges

- sudden lighting changes
- adverse environmental conditions, e.g. heavy rain or snow
- vehicle modifications, e.g. tyres
- load condition of the vehicle, i.e., whether the vehicle heavily or lightly loaded

A warning message may appear when the vehicle is travelling in a long straight lane on a smooth road surface even if the driver is holding the steering wheel properly.

Deactivate the system if the system is disturbed by tar marks, shadows, road cracks, temporary or construction lane markings, or other road imperfections.

### Warning

Always keep your attention on the road and maintain proper vehicle position within the lane, otherwise vehicle damage, injury or death could occur.

The system may not keep the vehicle in the lane or give an alert, even if a lane marking is detected.

The steering of the advanced lane keep assist may not be sufficient to avoid a lane departure.

The system may not detect hands-off driving due to external influences (road condition and surface, weather etc). The driver has full responsibility to control the vehicle and is always required to keep the hands on the steering wheel while driving.

Using the system while towing a trailer or on slippery roads could cause loss of control of the vehicle and a crash. Switch the system off.

## Driver alert

The driver alert system monitors the driving time and the vigilance of the driver. Monitoring the vigilance of the driver is based on the trajectory variations of the vehicle compared to the lane markings.

The system cannot replace the need for vigilance on the part of the driver. Taking a break is recommended as soon as feeling tired or at least every 2 hours. Do not drive when feeling tired.

### **Activation or Deactivation**

The system can be activated or deactivated in the Info Display ↗ 88.

The state of the system stays in memory when the ignition is switched off.

### **Driving time alert**

The driver gets notified by a pop-up reminder symbol 🗨️ in the Driver Information Centre simultaneously with an acoustic alert if the driver has not taken a break after 2 hours of driving at a speed above 40 mph. The alert is repeated hourly until the vehicle is stopped, no matter how vehicle speed evolves.

The counting of driving time alert is reset when the ignition has been switched off for a few minutes.

### **Driver drowsiness detection**

The system monitors the driver's level of vigilance. A camera at the top of the windscreen detects variations in trajectory compared to the lane markings. This system is particularly suited to fast roads (speed higher than 40 mph).

If the trajectory of the vehicle suggests a certain level of drowsiness or inattention by the driver, the system triggers the first level of alert. The driver is notified by a message and an audible signal is given.

After three first level alerts, the system triggers a new alert with a message, accompanied by a more pronounced audible signal.

In certain driving conditions (poor road surface or strong winds), the system may give alerts independent of the driver's level of vigilance.

The driver drowsiness detection is reinitialised when the ignition has been switched off for a few minutes or the speed remains below 40 mph for a few minutes.

### **System limitations**

In the following situations, the system may not operate properly or even not operate at all:

- poor visibility caused by inadequate lighting of the roadway, falling snow, heavy rain, dense fog etc.
- dazzle caused by headlamps of an oncoming vehicles, low sun, reflections on damp roads, leaving a tunnel, alternating shade and light etc.
- windscreen area in front of the camera covered by dirt, snow, stickers etc.
- no lane markings detected or multiple lane markings due to roadworks
- close vehicles ahead
- winding roads or narrow roads



## Charging

### General information

#### ⚠ Warning

Persons with a pacemaker should consult a doctor for possible precautions.

Charging the vehicle's high voltage battery depends upon several factors:

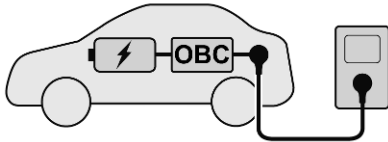

- high voltage battery of the vehicle
- internal onboard charger (OBC)
- external charging device
- charging cable

The charging cable connects the vehicle's high voltage battery with an external charging device providing electric power. This may be a

domestic electrical outlet, a Green'Up socket, a wall box or a public charging station.

The high voltage battery can be charged with direct current (DC) only. When charging from a domestic electrical outlet or a wall box, AC has to be converted into DC. This is done by the vehicle's onboard charger. The onboard charger is available with 3.7 kW (single-phase) and 7.4 kW (3-phase).

The speed of charging the vehicle's high voltage battery depends upon the weakest element of the charging chain. To achieve the maximum charging speed, charging cable and charging device have to be attuned to each other.

#### Notice

Make sure that the charging cable used fits to the vehicle's onboard charger.

Charging types ⇨ 183.

Charging cable ⇨ 185.

### Electric power consumption and range

The electric power consumption (combined) is within a range of 17.5 to 16.5 kWh/100 km.

The range is up to 35 miles.

For the values specific to your vehicle, refer to the EEC Certificate of Conformity provided with your vehicle or other national registration documents.

The determination of electric power consumption is regulated by directive R (EC) No. 715/2007 and No. 2017/1151 (in the latest applicable version).

### Charging types

There are different types of charging the vehicle's high voltage battery.

**Charging at wallboxes**

A wallbox is a charging unit for private households. It provides a charging cable which has to be connected to the vehicle's charging port. Some wallboxes do not provide a charging cable. In this case, a separate charging cable is required which has to be connected to both the wallbox and the charging port of the vehicle.

Charging time may take approx. 4 hours with a charging power of 3.7 kW and 2 hours with a charging power of 7.4 kW.

**Charging at charging stations**

Charging stations may provide alternating current (AC) or direct current (DC). Charging time may vary depending on the charging station, DC charging stations provide the fastest charging. To charge the

vehicle's battery, the charging cable of the charging station has to be connected to the charging port of the vehicle. Some charging stations do not provide a charging cable. In this case, a separate charging cable is required which has to be connected to both the charging station and the charging port of the vehicle.



- AC charging station: Charging time may take approx. 4 hours with a charging power of 3.7 kW and 2 hours with a charging power of 7.4 kW.



- DC charging station: Up to approx. 80% of battery capacity may be charged in approx. 0.5 hours at a charging power of 100 kW.

**Charging at domestic electrical outlets**

The vehicle's high voltage battery can be charged at a domestic electrical outlet. Connect the charging cable to the vehicle's charging port and to the domestic electrical outlet.

Charging time may take approx. 8 hours with a charging power of 1.8 kW.

## Charge cord

### **⚠ Danger**

There is a risk of electric shock that may cause personal injury or death.

Do not use the charging cable if any part of the charging cable is damaged.

Do not open or remove the charging cable cover.

Service by qualified personnel only. Connect the charging cable to a properly grounded outlet with cables that are not damaged.

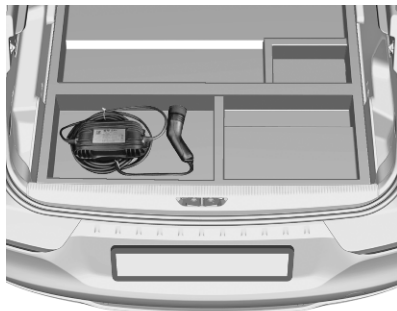

A portable charging cable used to charge the vehicle high voltage battery is stored under the rear floor storage cover in the load compartment ⇨ 187. The charging cable is compatible with the domestic electrical outlet of the respective country. It includes a control box with charging status indicators.

If the vehicle is to be used abroad, check whether the wall plug of the charging cable is compatible with the local electrical outlets. If a different charging cable is needed, consult a workshop.

### **Important information about portable electric vehicle charging**

- Charging an electric vehicle can stress a building's electrical system more than a typical household appliance.
- Before you plug in to any electrical outlet, have a qualified electrician inspect and verify the electrical system (electrical outlet, wiring, junctions and

protection devices) for heavy-duty service at a 10 A continuous load.

- Electrical outlets may wear out with normal usage or be damaged over time, making them unsuitable for electric vehicle charging.
- Check the electrical outlet / plug while charging and discontinue use if the electrical outlet / plug is hot, then have the electrical outlet serviced by a qualified electrician.
- When outdoors, plug into an electrical outlet that is weather-proof while in use.
- Mount the charging cable to reduce strain on the electrical outlet / plug.

**⚠ Warning**

Improper use of portable charging cables may cause a fire, electrical shock, or burns, and may result in damage to property, serious injury, or death.

- Do not use extension cables, multi-outlet power strips, splitters, grounding adaptors, surge protectors, or similar devices.
- Do not use an electrical socket that is worn or damaged, or one that will not hold the plug firmly in place.
- Do not immerse the charging cable into any liquid.
- Do not use an electrical socket that is not properly grounded.
- Do not use an electrical socket that is on a circuit with other electrical loads.

**⚠ Warning**

Read all the safety warnings and instructions before using this product. Failure to follow the warnings and the instructions may result in electric shock, fire, and / or serious injury.

Never leave children unattended near the vehicle while the vehicle is charging and never allow children to play with the charging cable.

If the plug provided does not fit the electrical outlet, do not modify the plug. Arrange for a qualified electrician to inspect the electrical outlet.

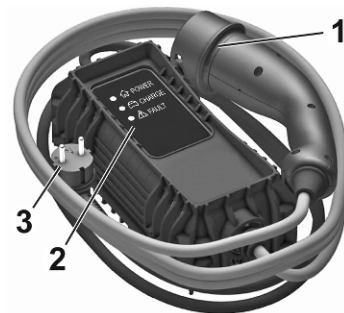

Do not put fingers into the electric vehicle connector.



1. Vehicle plug
2. Status indicators
3. Wall plug

**Charging cable status indicators**

After plugging in the charging cable, it will perform a quick self test and all status indicators come on for a moment. Verify the status:

-  **Power**  
Illuminates green: Charging is complete or in standby.
-  **Charge**  
Illuminates green: Charging cable is connected to the vehicle

and the domestic electrical outlet. No charging is going on, e.g., the battery is full.

Flashes green: High voltage battery is not fully charged.

Charging process is going on or programmable charging is active.

- **⚠ Fault**

Illuminates red: Fault.

The charging cable is defective. Seek the assistance of a workshop.

If no status indicator comes on, verify the circuit breaker of the electrical outlet:

- If the circuit breaker has broken, contact a qualified electrician to verify the compatibility of the electrical installation and repair it.
- If the circuit breaker has not broken, the charging cable may be defective. Do not use the charging cable and contact a workshop.

### Grounding instructions

This product must be grounded. If this product should malfunction or break down, grounding provides a path of least resistance for electric current to reduce the risk of electric shock. This product is equipped with a cable that has a grounding conductor. The plug must be plugged into an appropriate outlet that is properly installed and grounded in accordance with all local codes and ordinances.

#### ⚠ Warning

Improper connection of the charging cable ground may cause electrical shock. Check with a qualified electrician if there is doubt as to whether the charging circuit is properly grounded. Do not modify the plug provided with the product. If it will not fit the electrical outlet, have a proper electrical outlet installed by a qualified electrician.

### Charging

#### ⚠ Warning

Persons with a pacemaker should consult a doctor for possible precautions.

In order to ensure the compatibility of plug and outlet, a label used. The label is located on the inside of the vehicle's charging port flap. Make sure to connect only a cable of the same type.



Type 2 plug or outlet used for AC charging

**⚠ Warning**

Avoid any entry of fluids into the charging port of the vehicle, the vehicle plug of the charging cable and the domestic electrical outlet.

When charging at a public AC charging station, follow the instructions for the use of the respective charging station. Public AC charging stations may not provide an integrated charging cable. In this case, a portable mode 3 charging cable is required.

**⚠ Warning**

When charging at a domestic electrical outlet, only use an outlet which is properly grounded and protected by a 30 mA differential switch.

Only use a domestic electrical outlet protected by a circuit breaker adapted to the amperage of the electrical circuit.

Have a qualified electrician check the electrical installation to be used. The installation has to be in compliance with national standards and compatible with the vehicle.

When using a dedicated domestic electrical outlet, have it installed by a qualified electrician.

Make sure that the electrical outlet, the plug and the cable do not support the weight of the control box.

1. Shift into **P** and switch off the vehicle.



2. Push the charging port flap to release it.

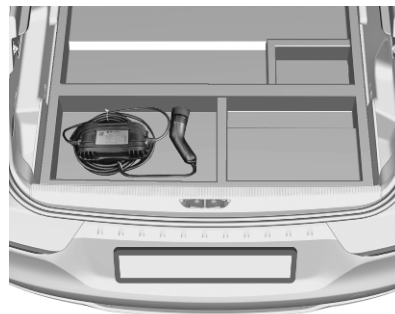

3. If necessary, take the charging cable out of the load compartment.
  4. If necessary, plug in the plug of the charging cable into the corresponding port of the external power source.
- Charging cable ⇨ 185.

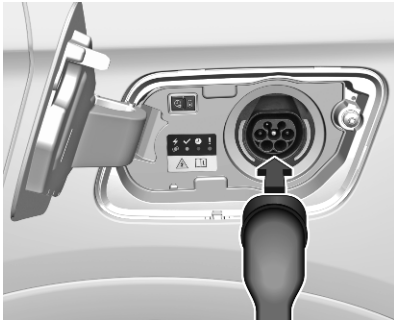

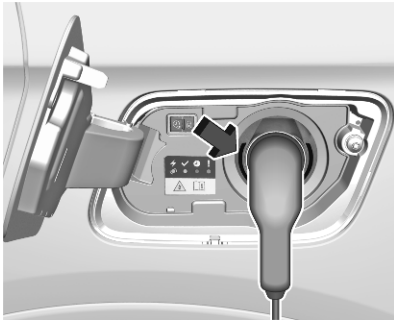

5. Plug in the vehicle plug of the charging cable into the charging port of the vehicle.

Charging status ⇨ 191.

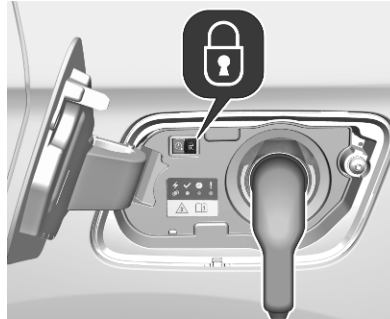

The start of charging is indicated by the green flashing of the status indicator at the charging port and at the control box of the charging cable if available.



Once charging, the vehicle plug will be locked to the charging port and cannot be disconnected while charging is active.  indicator illuminates.

Charging types ⇨ 183

## Cancelling the charging process

### Notice

At public charging stations, the cancelling and subsequent resuming of the charging process may cause additional costs.

Once the charging process has started, only the driver's door can be unlocked without cancelling the charging process. Therefore, activate the driver's door only function in the vehicle personalisation.

Press  on the remote control to cancel the charging process at any time.

Press  twice to cancel the charging process at any time if the function **driver's door only** is activated in the vehicle personalisation.

Central locking system ⇨ 9.

Vehicle personalisation ⇨ 92.

## Stop charging

The high voltage battery is fully charged if the status indicator on the charging port permanently illuminates green.

1. Unlock the vehicle before removing the vehicle plug from the charging port.

If the vehicle is already unlocked, lock the vehicle and unlock it again.



2. Disconnect the vehicle plug of the charging cable from the charging port within 30 seconds after unlocking.



3. Close the charging port flap by pressing firmly in the centre to latch properly.
4. Disconnect the charging cable from the external power source.
5. If necessary, store the charging cable in the load compartment.

While the charging cable is plugged into the vehicle, the vehicle cannot be driven.

## Programmable charging

By default, charging starts as soon as the vehicle plug of the charging cable is plugged into the charging port of the vehicle. It is also possible to schedule charging using the Info Display.



1. Press .
2. Select **Charge**.
3. Press .
4. Define the number of hours and minutes after which the loading process starts.
5. Press **OK**.
6. Plug in the vehicle.



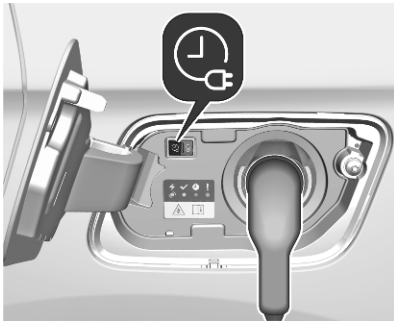

7. Within 1 minute, press  to activate programmable charging.

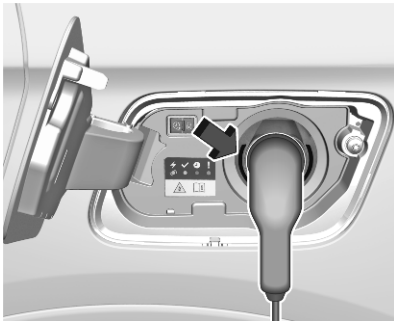

The status indicator illuminates blue indicating that programmable charging is active.

Charging status ⇨ 191.

Charging ⇨ 187.

## Charging status

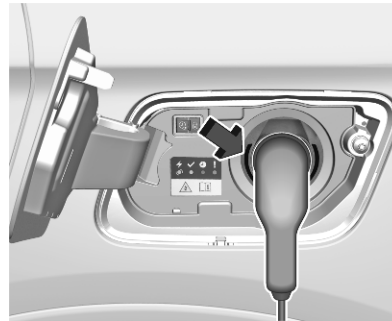

If the vehicle is plugged in and the ignition is switched off, the charging status indicator indicates the following:

- Illuminates white: welcome lighting when charging port flap is opened
- Illuminates green: charging complete
- Flashes green: high voltage battery charging
- Illuminates red: charging fault
- Illuminates blue: programmable charging active

A charging fault has occurred if the vehicle is plugged in and the charging status indicator is off.

Further charging status indicators are located on the control box of the charging cable.

Charging cable ⇨ 185.

Programmable charging ⇨ 190.

## Fuel

### Fuel for petrol engines



Only use unleaded fuel that complies with European standard EN 228 or E DIN 51626-1 or equivalent.

The engine is capable of running with fuel that contains up to 10% ethanol (e.g. named E10).

Use fuel with the recommended octane rating. A lower octane rating can reduce engine power and torque and slightly increases fuel consumption.

### Caution

Do not use fuel or fuel additives that contain metallic compounds such as manganese-based additives. This may cause engine damage.

### Caution

Use of fuel with a lower octane rating than the lowest possible rating could lead to uncontrolled combustion and engine damage.

The engine specific requirements regarding octane rating are given in the engine data overview ↗ 251. A country-specific label at the fuel filler flap can supersede the requirement. In certain countries, the use of a particular fuel, e.g. a specific octane rating, may be required to ensure proper engine operation.

## Fuel for diesel engines

The Diesel engines are compatible with bio-fuels that conform to current and future European standards and can be obtained from filling stations:

A square icon with a thick black border containing the text 'B7'.

Diesel fuel that meets standard EN590 mixed with a biofuel that meets standard EN14214 (possibly containing up to 7% Fatty Acid Methyl Ester).

A square icon with a thick black border containing the text 'B10'.

Diesel fuel that meets standard EN16734 mixed with a biofuel that meets standard EN14214 (possibly containing up to 10% Fatty Acid Methyl Ester).



Paraffinic Diesel fuel that meets standard EN15940 mixed with a biofuel that meets standard EN14214 (possibly containing up to 7% Fatty Acid Methyl Ester).

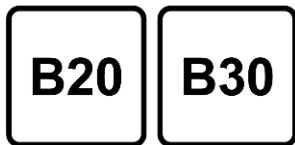

The use of B20 or B30 fuel meeting standard EN16709 is possible in your Diesel engines. However, this use, even occasional, requires strict

application of the special servicing conditions referred to as "Arduous conditions".

For more information, contact a dealer or a qualified workshop.

### Caution

The use of any other type of (bio) fuel (vegetable or animal oils, pure or diluted, domestic fuel etc.) is strictly prohibited (risk of damage to the engine and fuel system).

### Notice

The only Diesel additives authorised for use are those that meet the B715000 standard.

### Low temperature operation

At temperatures below 0 °C, some diesel products with biodiesel blends may clog, freeze or gel, which may affect the fuel supply system. Starting and engine operation may not work properly. Make sure to fill winter grade diesel fuel at ambient temperatures below 0 °C.

Arctic grade diesel fuel can be used at extremely low temperatures below -20 °C. Using this fuel grade in warm or hot climates is not recommended and may cause engine stalling, poor starting or damage on the fuel injection system.

### Refuelling



**⚠ Danger**

Before refuelling, switch off ignition and any external heaters with combustion chambers.

Follow the operating and safety instructions of the filling station when refuelling.

**⚠ Danger**

Fuel is flammable and explosive. No smoking. No naked flames or sparks.

If you can smell fuel in your vehicle, have the cause of this remedied immediately by a workshop.

A label with symbols at the fuel filler flap is indicating the allowed fuel types. In Europe the pump nozzles of the filling stations are marked with these symbols. Refuel only the allowed fuel type.

**Caution**

In case of misfuelling, do not switch on ignition.

Fuel filler flap is located at right rear side of vehicle.



The fuel filler flap can only be opened if the vehicle is unlocked. Open the fuel filler flap by pushing the flap.

To open the fuel filler flap of a hybrid vehicle, a depressurisation phase is required to avoid the emission of fuel vapour. This can take up to one minute.



Press . After depressurisation the fuel filler flap is unlocked and bounces a bit.



## Petrol and diesel refuelling

To open, turn the cap slowly anticlockwise.

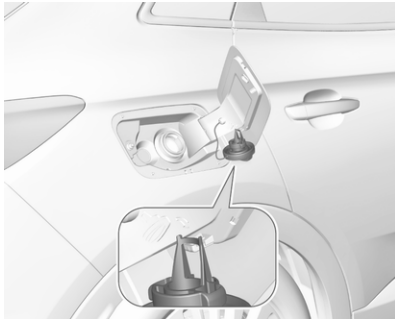

The fuel filler cap can be attached to the hook on the fuel filler flap.

Place the nozzle in straight position to the filler neck and press with slight force to insert.

To refuel, switch on pump nozzle.

After the automatic cut-off, the tank can be topped up by operating the pump nozzle a maximum of two more times.

### Caution

Wipe off any overflowing fuel immediately.

To close, turn the fuel filler cap clockwise until it clicks.

Close the flap and allow it to engage.

### Fuel filler cap

Only use genuine fuel filler caps.

Diesel-engined vehicles have special fuel filler caps.

## Fuel consumption - CO<sub>2</sub>-Emissions

The fuel consumption (combined) is within a range of 36 to 58 mpg.

The CO<sub>2</sub> emission is within a range of 176 to 128 g/km.

## General information

For the values specific to your vehicle, refer to the EEC Certificate of Conformity provided with your vehicle or other national registration documents.

The determination of fuel consumption is regulated by directive R (EC) No. 715/2007 and No. 2017/1151 (in the latest applicable version).

The specification of CO<sub>2</sub> emission is also a constituent of the directive.

The figures given must not be taken as a guarantee for the actual fuel consumption of a particular vehicle. Furthermore, fuel consumption is dependent on personal driving style as well as road and traffic conditions.

All values are based on the EU base model with standard equipment.

The calculation of fuel consumption takes into account the vehicle's kerb weight, ascertained in accordance with the regulations. Optional equipment may result in slightly

higher fuel consumption and CO<sub>2</sub> emission levels and a lower maximum speed.

## **Trailer hitch**

### **General information**

Only use towing equipment that has been approved for your vehicle. If using non-factory fitted towing equipment, deactivation of the hands-free tailgate operation may be required ⇨ 15.

Entrust retrofitting of towing equipment to a workshop. It may be necessary to make changes that affect the cooling system, heat shields or other equipment.

The bulb outage detection function for trailer brake light cannot detect a partial bulb outage. E.g. in case of four bulbs with a power of 5 W each, the function only detects light outage when only a single 5 W light remains or none remain.

Trailers equipped with LED lights are not suitable for the wiring harness of this trailer hitch.

Fitting of towing equipment could cover the opening of the towing eye. If this is the case use the coupling ball

bar for towing. Always keep the coupling ball bar in the vehicle to have it on hand if needed.

### **Driving characteristics and towing tips**

Before attaching a trailer, lubricate the coupling ball. However, do not do so if a stabiliser, which acts on the coupling ball, is being used to reduce snaking movements.

During trailer towing do not exceed a speed of 50 mph. A maximum speed of 60 mph is only appropriate if an oscillation damper is used and the permissible gross trailer weight does not exceed the vehicle's curb weight.

For trailers with low driving stability and caravan trailers, the use of an oscillation damper is strongly recommended.

If the trailer starts snaking, drive more slowly, do not attempt to correct the steering and brake sharply if necessary.

When driving downhill, drive in the same gear as if driving uphill and drive at a similar speed.

Adjust tyre pressure to the value specified for full load ⇨ 256.

## Trailer towing

### Trailer loads

The permissible trailer loads are vehicle and engine-dependent maximum values which must not be exceeded. The actual trailer load is the difference between the actual gross weight of the trailer and the actual coupling socket load with the trailer coupled.

The permissible trailer loads are specified in the vehicle documents. In general, they are valid for inclines up to 12%.

The permissible trailer load applies up to the specified incline and at sea level. Since engine power decreases as altitude increases due to the air becoming thinner, therefore reducing climbing ability, the permissible gross train weight also decreases by 10% for every 1000 m of altitude. The gross train weight does not have to be

reduced when driving on roads with slight inclines (less than 8%, e.g. motorways).

The permissible gross train weight must not be exceeded. This weight is specified on the identification plate ⇨ 247.

### Vertical coupling load

The vertical coupling load is the load exerted by the trailer on the coupling ball. It can be varied by changing the weight distribution when loading the trailer.

The maximum permissible vertical coupling load (70 kg) is specified on the towing equipment identification plate and in the vehicle documents.

Always aim for the maximum vertical coupling load, especially in the case of heavy trailers. The vertical coupling load should never fall below 25 kg.

### Rear axle load

When the trailer is coupled and the towing vehicle fully loaded, the permissible rear axle load (see identification plate or vehicle documents) may be exceeded by 60 kg, the gross vehicle weight rating must not be exceeded. If the permissible rear axle load is exceeded, a maximum speed of 60 mph applies.

## Towing equipment

### Caution

When operating without a trailer, remove the coupling ball bar.

### Fitting the coupling ball bar

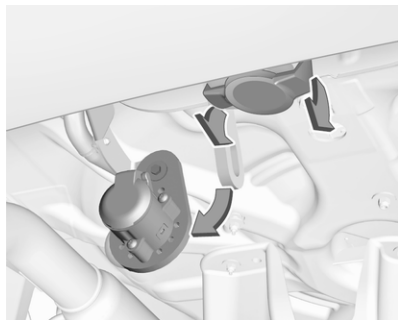

Disengage and fold down the socket. Remove the sealing plug from the opening for the coupling ball bar and stow it.

### Checking the tensioning of the coupling ball bar



- Red marking on rotary knob must point towards green marking on coupling ball bar.
- The gap between the rotary knob and the coupling ball bar must be approx. 6 mm.

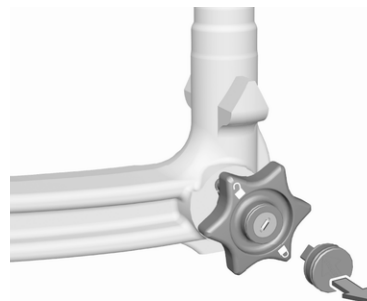

- Remove the cover from the lock of the rotary knob and verify whether the rotary knob is locked. If the rotary knob cannot be turned, it is locked.

Otherwise, the coupling ball bar must be tensioned before being inserted:

- Unlock coupling ball bar by turning key to position .



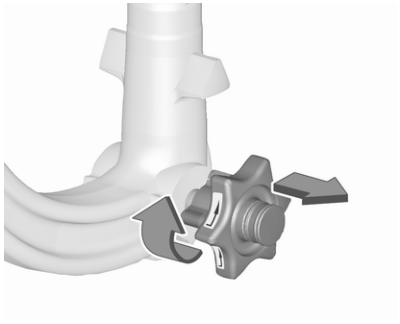

- Pull out rotary knob and turn clockwise as far as it will go.

**Inserting the coupling ball bar**

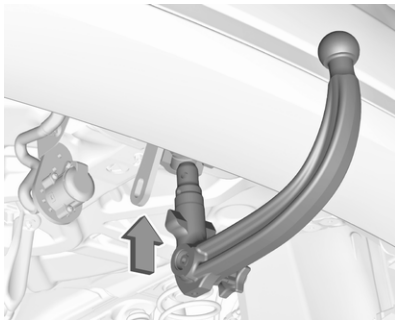

Insert the tensioned coupling ball bar in the opening and push firmly upwards until it audibly engages.

The rotary handle snaps back into its original position resting against the coupling ball bar without a gap.

<b>⚠ Warning</b>
Do not touch rotary handle during insertion.

Lock the coupling ball bar by turning the key to position . Remove the key and close the protective flap.

**Eye for break-away stopping cable**

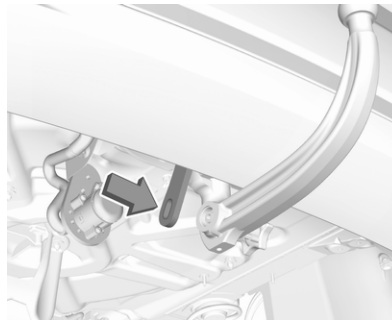

Attach breakaway stopping cable to eye.

**Check that the coupling ball bar is correctly installed**

- Green marking on rotary knob must point towards green marking on coupling ball bar.
- There must be no gap between the rotary handle and the coupling ball bar.
- The coupling ball bar must be firmly engaged in the opening.
- The coupling ball bar must be locked and the key removed.

<b>⚠ Warning</b>
Towing a trailer is permitted only when a coupling ball bar is fitted correctly. If the coupling ball bar does not engage correctly, seek the assistance of a workshop.

### Dismounting the coupling ball bar

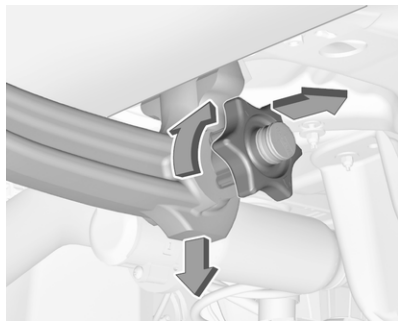

Open the protective flap and turn the key to position  to unlock the coupling ball bar.

Pull out rotary handle and turn clockwise as far as it will go. Pull out coupling ball bar downwards.

Insert sealing plug in opening. Fold away socket.

### Trailer stability assist

If the system detects snaking movements, engine power is reduced and the vehicle / trailer combination is

selectively braked until the snaking ceases. While system is working keep steering wheel as still as possible.

Trailer stability assist is a function of the Electronic Stability Control ↗ 142.

## Vehicle care

<b>General Information</b> .....	<b>201</b>
Accessories and vehicle modifications .....	201
Vehicle storage .....	203
End-of-life vehicle recovery .....	205
<b>Vehicle checks</b> .....	<b>205</b>
Performing work .....	205
Bonnet .....	206
Engine oil .....	207
Engine coolant .....	208
Washer fluid .....	208
Brakes .....	209
Brake fluid .....	209
Vehicle battery .....	209
Diesel fuel system bleeding .....	211
Wiper blade replacement .....	211
<b>Bulb replacement</b> .....	<b>212</b>
LED headlights .....	212
Front fog lights .....	213
Tail lights .....	213
Side turn lights .....	216
Number plate light .....	216
Interior lights .....	216
<b>Electrical system</b> .....	<b>217</b>
Fuses .....	217

Engine compartment fuse box .....	217
Instrument panel fuse box .....	218
<b>Vehicle tools</b> .....	<b>220</b>
Tools .....	220
<b>Wheels and tyres</b> .....	<b>221</b>
Winter tyres .....	221
Tyre designations .....	222
Tyre pressure .....	222
Tyre deflation detection system .....	223
Tread depth .....	224
Changing tyre and wheel size .....	224
Wheel covers .....	225
Tyre chains .....	225
Tyre repair kit .....	225
Wheel changing .....	228
Spare wheel .....	230
<b>Jump starting</b> .....	<b>233</b>
<b>Towing</b> .....	<b>235</b>
Towing the vehicle .....	235
Towing another vehicle .....	236
<b>Appearance care</b> .....	<b>237</b>
Exterior care .....	237
Interior care .....	239
Floor mats .....	239

## General Information

### Accessories and vehicle modifications

We recommend the use of genuine parts and accessories and factory approved parts specific for your vehicle type. We cannot assess or guarantee reliability of other products - even if they have a regulatory or otherwise granted approval.

Any modification, conversion or other changes made to standard vehicle specifications (including, without limitation, software modifications, modifications of the electronic control units) may invalidate the warranty offered by Vauxhall. Furthermore, such changes may affect driver assistance systems, may impact fuel consumption, CO<sub>2</sub> emissions and other emissions of the vehicle and cause the vehicle to no longer conform to the operating permit, impacting the validity of your vehicle registration.

**Caution**

When transporting the vehicle on a train or on a recovery vehicle, the mud flaps might be damaged.

**Cold protection covers**

It is recommended to have the protection covers installed by a workshop.

**Caution**

The protection covers must be removed when one of the following conditions occurs:

- The ambient temperature is above 10 °C.
- When the vehicle is towed.
- The vehicle is driven at speeds above 75 mph.

**Installation**

1. Install the protection cover as shown.

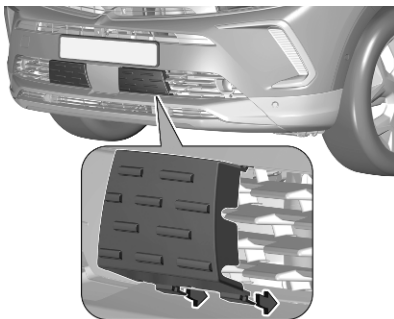

2. Press the lower part of the protection cover against the slat of the grille. Ensure that the protection cover is fixed securely.
3. Repeat the procedure for the other protection covers.

**Deinstallation**

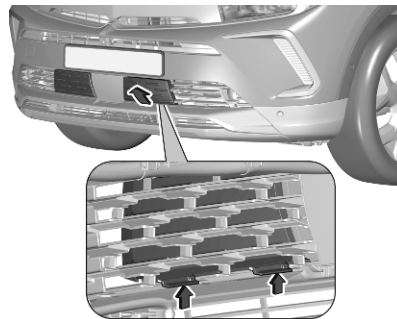

1. With your hand behind the grille, push the brackets of the protection cover upwards to release the protection cover.
2. Pull the protection cover upwards and remove it.
3. Repeat the procedure for the other protection covers.

## Vehicle storage

### Storage for a long period of time

If the vehicle is to be stored for several months:

- Wash and wax the vehicle.
- Have the wax in the engine compartment and underbody checked.
- Clean and preserve the rubber seals.
- Fill up fuel tank completely.
- Change the engine oil.
- Drain the washer fluid reservoir.
- Check the coolant antifreeze and corrosion protection.
- Adjust tyre pressure to the value specified for full load.
- Park the vehicle in a dry, well ventilated place. Engage first or reverse gear or set selector lever to **P**. Prevent the vehicle from rolling.
- Do not apply the parking brake.
- Open the bonnet, close all doors and lock the vehicle.

### Storage for a long period of time (hybrid vehicle)

If the vehicle is to be stored for several months:

- Wash and wax the vehicle.
- Have the wax in the engine compartment and underbody checked.
- Clean and preserve the rubber seals.
- Drain the washer fluid reservoir.
- Check the coolant antifreeze and corrosion protection.
- Adjust tyre pressure to the value specified for full load.
- Park the vehicle in a dry, well ventilated place. Engage first or reverse gear or set selector lever to **P**. Prevent the vehicle from rolling.
- Do not apply the parking brake.
- Open the bonnet, close all doors and lock the vehicle.

#### Up to four weeks

Plug in the charge cord.

### Four weeks to twelve months

- Discharge the high voltage battery until 30 percent remain on the battery range indicator (battery symbol) on the Driver Information Centre.
- Do not plug in the charge cord.
- Always store the vehicle in a place with temperatures between  $-10^{\circ}\text{C}$  and  $30^{\circ}\text{C}$ .
- Vehicle storage at extreme temperatures may cause damage to the high voltage battery.
- Every three months, check the high voltage battery's state of charge. If the state of charge is below 30 percent, recharge the high voltage battery to 30 percent.
- Disconnect the 12 V batteries.

#### Disconnecting the 12 V batteries

Before disconnecting the 12 V batteries:

- Close doors, windows, boot and roof.
- Switch off all electrical consumers.
- Switch off the engine and wait for four minutes.

First, disconnect the negative (-) terminal of the rear battery. Then, disconnect the positive (+) terminal of the front battery.

To disconnect the negative (-) terminal of the rear battery:

1. Open the load compartment.
2. Lift and remove the rear floor cover.
3. Lift and remove the rear floor.

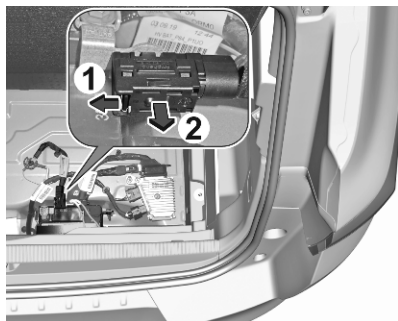

4. Push (1) the unlock lever and remove (2) the lead from the connection pin.

To disconnect positive (+) terminal of the front battery:

1. Open the bonnet.

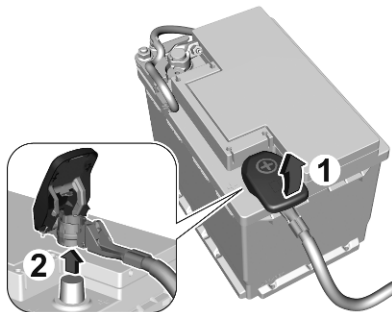

2. Pull (1) the lever of the clamp of the positive (+) terminal upwards and remove (2) the clamp from the terminal.

### Putting back into operation

When the vehicle is to be put back into operation:

- Connect the clamp to the negative terminal of the vehicle battery. Initialise the power windows ⇨ 25.
- Check tyre pressure.
- Fill up the washer fluid reservoir.
- Check the engine oil level.
- Check the coolant level.
- Fit the number plate if necessary.

### Putting back into operation (hybrid vehicle)

When the vehicle is to be put back into operation:

- Check tyre pressure.
- Fill up the washer fluid reservoir.
- Check the coolant level.
- Fit the number plate if necessary.
- Connect the 12 V batteries.

### Connecting the 12 V batteries

First, connect the positive (+) terminal of the front battery. Then, connect negative (-) terminal of the rear battery.

To connect the positive (+) terminal of the front battery:

1. Pull the lever of the clamp of the corresponding terminal upwards.
2. Put the clamb on the terminal and push it down.
3. Push down the lever of clamp.

To connect the negative (-) terminal of the rear battery:

1. Lift the rear floor cover.
2. Push the unlock lever and connect the lead to the connection.

### End-of-life vehicle recovery

Information on end-of-life vehicle recovery centres and the recycling of end-of-life vehicles is available on our website, where legally required. Only entrust this work to an authorised recycling centre.

## Vehicle checks

### Performing work

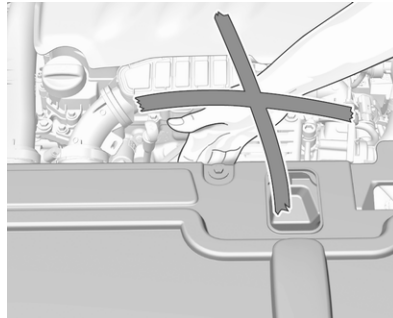

#### ⚠ Warning

Only perform engine compartment checks when the ignition is off.

The cooling fan may start operating even if the ignition is off.

#### ⚠ Danger

The ignition system uses extremely high voltage. Do not touch.



#### ⚠ Danger

Electric version:

Never try to perform maintenance work on high voltage components yourself. You may be injured and the vehicle may be damaged.

Service and repair of these high voltage components should only be performed by a trained service technician with proper knowledge and tools. Exposure to high voltage may cause shock, burns, and even death. The high voltage

components in the vehicle can only be serviced by technicians with special training.

High voltage components are identified by labels. Do not remove, open, take apart, or modify these components. High voltage cable or wiring has orange covering. Do not probe, tamper with, cut, or modify high voltage cable or wiring.

**⚠ Warning**

Electric version:

Only perform engine compartment checks when the vehicle is off.

The cooling fan may start operating even if the vehicle is off.

**Caution**

Electric version:

Even small amounts of contamination to the liquids can cause damage to vehicle systems.

Do not allow contaminants to contact the fluids, reservoir caps, or dipsticks.

**Bonnet**

**Opening**

Open the driver's door.

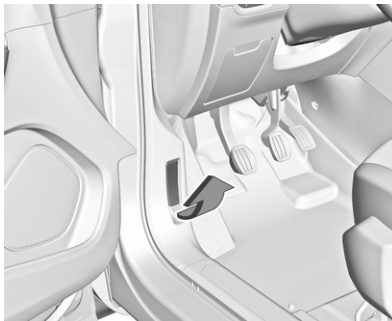

Pull the release lever and return it to its original position.



Push the safety catch upwards and open the bonnet.



Secure the bonnet support.



### Closing

Before closing the bonnet, press the support into the holder.

Lower the bonnet and let it fall into the latch from a low height (20-25 cm). Check that the bonnet is engaged.

### Caution

Do not press the bonnet into the latch to avoid dents.

### Engine oil

Check the engine oil level manually on a regular basis to prevent damage to the engine. Ensure that the correct specification of engine oil is used.

Recommended fluids and lubricants ⇨ 245.

The maximum engine oil consumption is 0.6 l per 600 miles.

Check with the vehicle on a level surface. The engine must be at operating temperature and switched off for at least 5 min.

### Caution

It is the owner's responsibility to maintain the proper level of an appropriate quality engine oil in the engine.

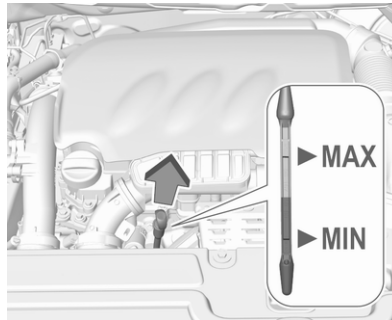

Pull out the dipstick, wipe it clean, reinsert it fully, pull out and read the engine oil level.

When the engine oil level has dropped to the **MIN** mark, top up the engine oil.

Different dipsticks are used depending on engine variant.

We recommend the use of the same grade of engine oil that was used at last change.

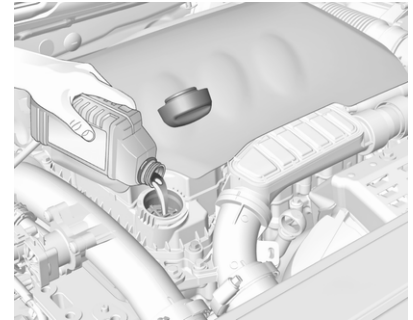

The engine oil level must not exceed the **MAX** mark on the dipstick.

### Caution

Overfilled engine oil must be drained or suctioned out. If the engine oil exceeds the maximum level, do not start the vehicle and contact a workshop.

Capacities ⇨ 255.

Fit the cap on straight and tighten it.

## Engine coolant

The factory filled coolant provides freeze protection down to approx. -37 °C.

### Caution

Only use approved antifreeze.

Coolant and antifreeze ⇄ 245.

## Coolant level

### Caution

Too low a coolant level can cause engine damage.

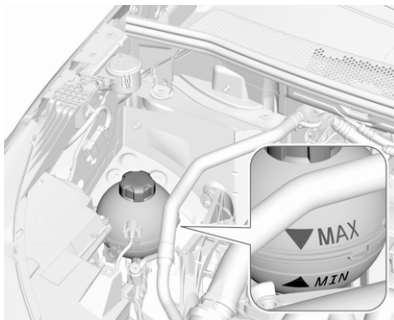

If the cooling system is cold, the coolant level should be above the **MIN** mark. Top up if the level is low.

### ⚠ Warning

Allow the engine to cool before opening the cap. Carefully open the cap, relieving the pressure slowly.

To top up, use a 1:1 mixture of released coolant concentrate mixed with clean tap water. If no coolant concentrate is available, use clean tap water. Install the cap tightly. Have

the coolant concentration checked and have the cause of the coolant loss remedied by a workshop.

## Washer fluid

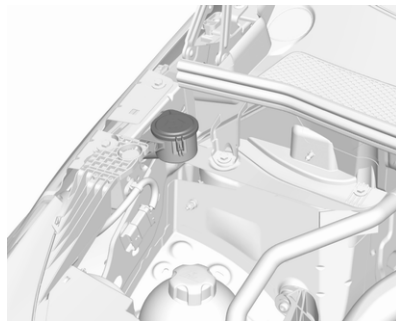

Fill with clean water mixed with a suitable quantity of approved windscreen washer fluid which contains antifreeze.

### Caution

Only washer fluid with a sufficient antifreeze concentration provides protection at low temperatures or a sudden drop in temperature.

Washer fluid ⇨ 245.

### Brakes

In the event of minimum thickness of the brake lining, a squealing noise sounds during braking.

Continued driving is possible but have the brake lining replaced as soon as possible.

Once new brake linings are installed, do not brake unnecessarily hard for the first few journeys.

### Brake fluid

#### ⚠ Warning

Brake fluid is poisonous and corrosive. Avoid contact with eyes, skin, fabrics and painted surfaces.

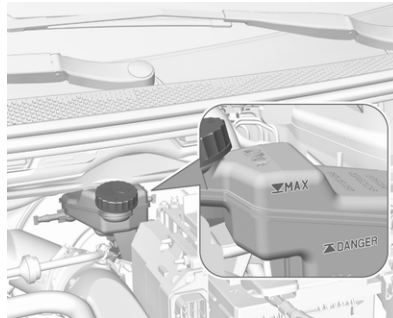

The brake fluid level must be between the **DANGER** and **MAX** marks.

If fluid level is below **DANGER** seek the assistance of a workshop.

Brake and clutch fluid ⇨ 245.

### Vehicle battery

The vehicle battery is maintenance-free provided that the driving profile allows sufficient charging of the battery. Short-distance-driving and frequent engine starts can discharge the battery. Avoid the use of unnecessary electrical consumers.



Batteries do not belong in household waste. They must be disposed of at an appropriate recycling collection point.

Laying up the vehicle for more than four weeks can lead to battery discharge. Disconnect the clamp from the negative terminal of the vehicle battery.

Ensure the ignition is switched off before connecting or disconnecting the vehicle battery.

Battery discharge protection ⇨ 105.

### Replacing the vehicle battery

#### Notice

Any deviation from the instructions given in this section may lead to temporary deactivation or disturbance of the stop-start system.

When the vehicle battery is being replaced, please ensure that there are no open ventilation holes in the vicinity of the positive terminal. If a ventilation hole is open in this area, it must be closed off with a dummy cap, and the ventilation in the vicinity of the negative terminal must be opened.

Ensure that the battery is always replaced by the same type of battery.

The vehicle battery has to be replaced by a workshop.

Stop-start system ⇨ 120.

### Charging the vehicle battery

#### Warning

On vehicles with stop-start system, ensure that the charging potential does not exceed 14.6 V when using a battery charger. Otherwise the vehicle battery may be damaged.

Jump starting ⇨ 233.

### Discharge protection

#### Battery voltage

When the vehicle battery voltage is running low, a warning message will appear in the Driver Information Centre.

When the vehicle is being driven, the load reduction function temporarily deactivates certain functions, such as the air conditioning, the heated rear window, heated steering wheel, etc.

The deactivated functions are reactivated automatically as soon as conditions permit.

#### Idle boost

If charging of the vehicle battery is required due to battery condition, the power output of the generator must be increased. This will be achieved by an idle boost which may be audible.

A message appears in the Driver Information Centre.

#### Power outlet

The power outlets are deactivated in the event of low vehicle battery voltage.

### Warning label



Meaning of symbols:

- No sparks, naked flames or smoking.
- Always shield eyes. Explosive gases can cause blindness or injury.
- The vehicle battery contains sulphuric acid which could cause blindness or serious burn injuries.
- Keep the vehicle battery out of reach of children.

- See the Owner's Manual for further information.
- Explosive gas may be present in the vicinity of the vehicle battery.

### Power saving mode

This mode deactivates electrical consumers to avoid excessive discharging of the vehicle battery. These consumers, such as the Infotainment system, windscreen wipers, low beam headlights, courtesy light, etc. can be used for a total maximum time of about 40 minutes after ignition is switched off.

### Changing into power saving mode

When power saving mode is activated, a message appears in the Driver Information Centre.

An active telephone call using the hands-free option will be maintained for around 10 minutes longer.

### Deactivating power saving mode

Power saving mode is deactivated automatically when the engine is restarted. Run the engine for a sufficient charge:

- for less than 10 minutes to use the consumers for approx. 5 minutes
- for more than 10 minutes to use the consumers for up to approx. 30 minutes

### Heating functionalities

#### Notice

Individual heating functionalities, such as heated seats or heated steering wheel, may be temporarily unavailable in the event of electrical loading constraints. Functions will be resumed after some minutes.

### Diesel fuel system bleeding

If the tank has been run dry, the diesel fuel system must be bled. Switch on the ignition three times for 15 seconds at a time. Then crank the engine for a maximum of 40 seconds. Repeat this process after no less than 5 seconds. If the engine fails to start, seek the assistance of a workshop.

### Wiper blade replacement

#### Windscreen

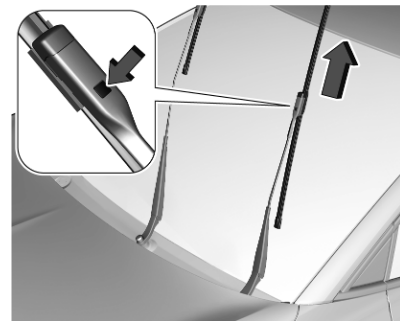

Switch off ignition.

Within one minute after switching off ignition, operate the wiper lever to position the wiper blades vertically on the windscreen.

Lift the wiper arm until it stays in the raised position, press button to disengage the wiper blade and remove.

Attach the wiper blade slightly angled to the wiper arm and push until it engages.

Lower wiper arm carefully.

### Rear window



Lift wiper arm. Disengage wiper blade as shown in illustration and remove.

Attach the wiper blade slightly angled to the wiper arm and push until it engages.

Lower wiper arm carefully.

## Bulb replacement

Before replacing a bulb, ensure that all exterior and interior lights and the ignition are switched off. All doors have to be closed.

Only hold a new bulb at the base. Do not touch the bulb glass with bare hands.

Use only the same bulb type for replacement.

Replace headlight bulbs from within the engine compartment.

### Bulb check

After a bulb replacement switch on the ignition, operate and check the lights.

## LED headlights

Headlights for low and high beam, sidelights, daytime running lights and turn lights are designed as LEDs and cannot be changed.

Have lights repaired by a workshop in case of failure.

## Front fog lights

Front fog lights are designed as LEDs and cannot be changed.

Have lights repaired by a workshop in case of failure.

## Tail lights

Tail lights, daytime running lights and 3rd-brake light are designed as LEDs. In case of failure, have LEDs replaced by a workshop.

### Light assembly in the body



1. Open the tailgate then unclip the access cover on the relevant side.



2. Slacken the light fixing nut using a box spanner or socket.  
To avoid losing the nut if it drops into the wing trim, first place a cloth below it.
3. Manually unscrew and remove the light fixing nut.
4. Disengage the retaining clip, while pushing the light out slightly.

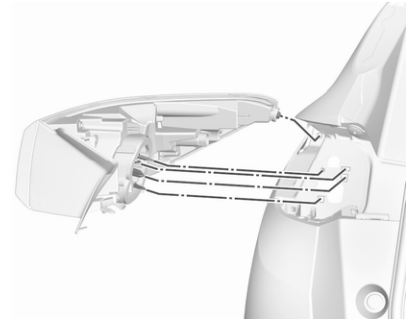

5. From the outside, carefully withdraw the light assembly from recess and remove. Take care that the cable duct remains in position.
6. Turn the bulb socket anticlockwise and remove it from the light assembly.

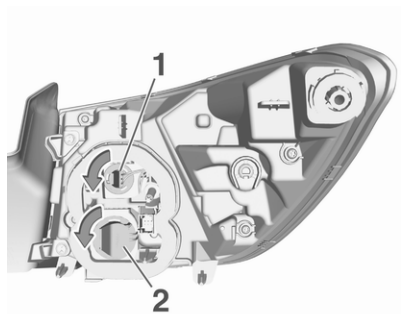

7. Detach the bulb from the bulb socket and replace the bulb.

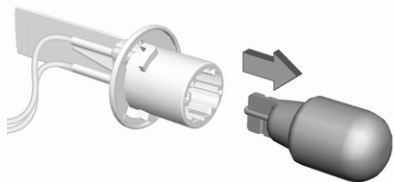

Brake light(1)

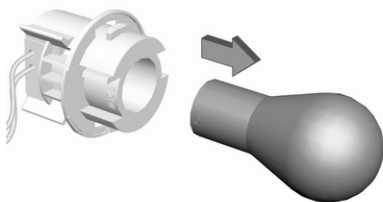

Turn light (2)

8. Insert the bulb socket into the light assembly. Fit the light assembly in the recess and tighten the light fixing nut from the inside. Attach the cover.

### Light assembly in the tailgate

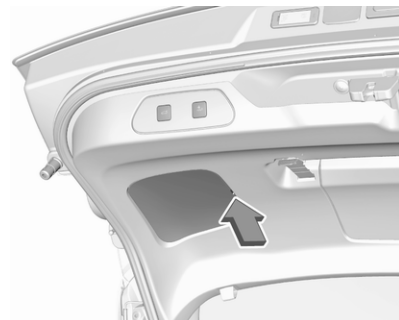

1. Open the tailgate and remove the cover.

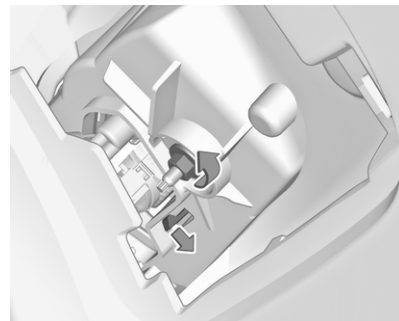



2. Slacken the light fixing nut using a box spanner or socket.
3. Manually unscrew and remove the light fixing nut.
4. Disengage the retaining clip, while pushing the light assembly out slightly.
5. From the outside, carefully withdraw light assembly from recess and remove. Take care that the cable duct remains in position.

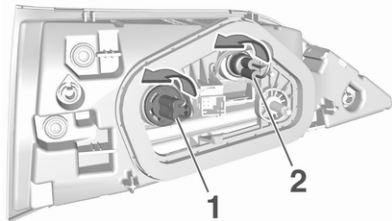

6. Turn the bulb socket anticlockwise and remove it from the light assembly.

7. Detach the bulb from the bulb socket and replace the bulb:

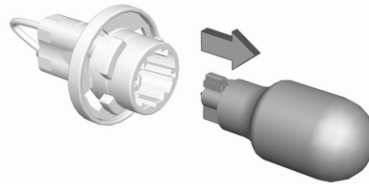

Reverse light (1)

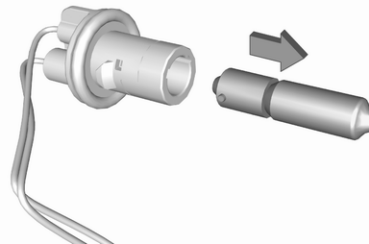

#### Rear fog light (2)

8. Insert the bulb socket into the light assembly. Fit the light assembly in the recess and tighten the light fixing nut from the inside. Attach the cover.

#### 3rd-brake light

The 3rd-brake light is designed as LED and can not be changed.

Have lights repaired by a workshop in case of failure.

#### Bulb check

Switch on the ignition, operate and check all lights.

## Side turn lights

To replace bulb, remove light assembly:

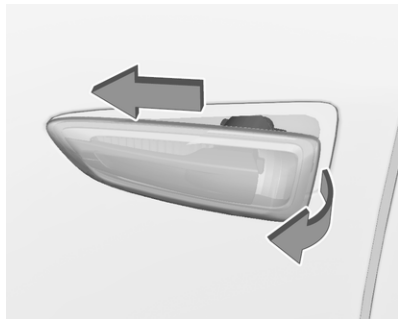

1. Slide the light assembly forward and remove it at the back.



2. Turn bulb socket clockwise and remove from light assembly.

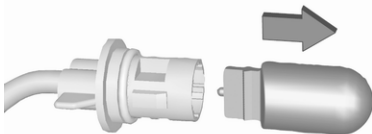

3. Detach the bulb from the bulb socket and replace the bulb.

4. Insert bulb socket and turn anticlockwise.
5. Insert left end of the light assembly, slide to the left and insert right end.

## Number plate light

Number plate lights are designed as LEDs and cannot be changed.

Have lights repaired by a workshop in case of failure.

## Interior lights

Have the following bulbs replaced by a workshop:

- courtesy light, reading lights
- load compartment light
- instrument panel illumination

## Electrical system

### Fuses

Data on the replacement fuse must match the data on the defective fuse.

There are two fuse boxes in the vehicle:

- engine compartment
- instrument panel

Before replacing a fuse, turn off the respective switch and the ignition.

A blown fuse can be recognised by its melted wire.

#### Caution

Do not replace the fuse until the cause of the fault has been remedied.

Some functions are protected by several fuses.

Fuses may also be inserted without existence of a function.

### Fuse extractor

A fuse extractor may be located in the fuse box in the engine compartment. The extractor has two sides, each side is designed for a different type of fuses.

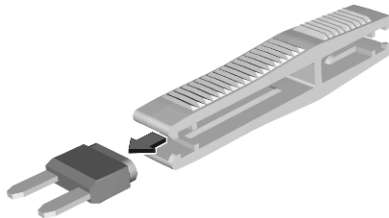

Grab the fuse with the fuse extractor and withdraw the fuse.

### Engine compartment fuse box

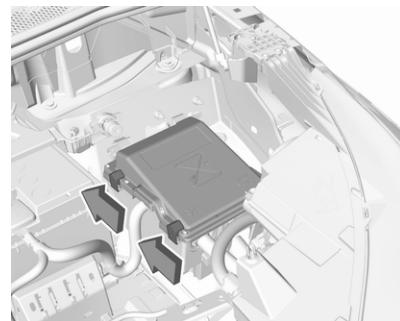

The fuse box is in the front left of the engine compartment.

Disengage the cover and remove it.

Depending on the version, different engine compartment fuse boxes are available:

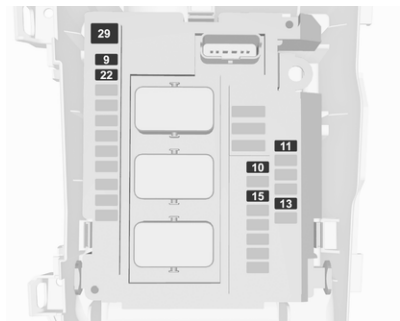

**No. Circuit**

- 9 Anti-theft alarm system
- 10 Stop-start system
- 11 Diesel exhaust system
- 13 Stop-start system
- 15 Electric power steering / Radar
- 22 Horn
- 29 Starter

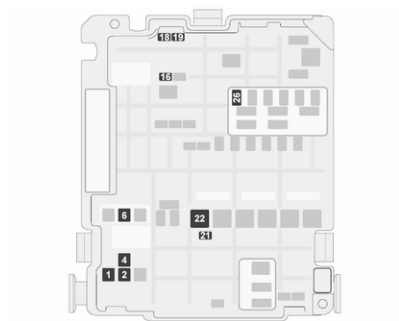

**No. Circuit**

- 1 Climate control
- 2 Steering wheel
- 4 Electric parking brake
- 6 Air vent
- 16 Front fog lights
- 18 Right high beam (Halogen) / Right headlight (LED)
- 19 Left high beam (Halogen) / Right headlight (LED)
- 21 Starter

**No. Circuit**

- 22 Heated windscreen
- 26 Additional Heater / Heated windscreen

After having changed defective fuses, close the fuse box cover and lock it.

If the fuse box cover is not closed correctly, malfunction may occur.

**Instrument panel fuse box**

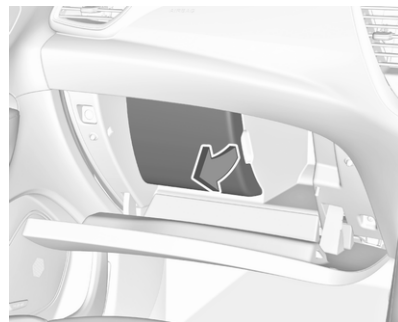

In right-hand drive vehicles, the fuse box is located behind a cover in the glovebox. Open the glovebox and remove the cover.

Depending on the version, different instrument panel fuse boxes are available:

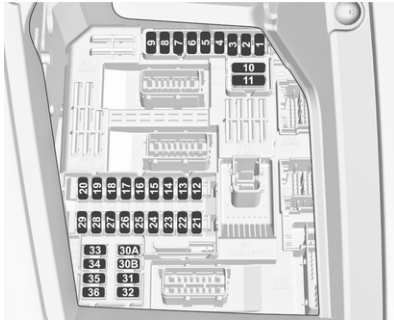

**No. Circuit**

- 1 Electronic key system / Anti-theft alarm system
- 4 Stop-start system
- 5 Advanced parking assist / Camera / Transmission control module
- 7 Amplifier
- 8 Rear wiper

**No. Circuit**

- 10 Central locking system
- 11 Central locking system
- 13 Anti-theft alarm system
- 16 Electrical power steering wheel
- 18 BTA module
- 21 Interior lights
- 22 Glovebox light
- 23 Blind spot alert system / Exterior mirror adjustment / Inductive charging
- 24 Column electrical assembly
- 25 Interior mirror
- 26 Seat belt reminder
- 27 Camera / Rain sensor / Automatic light control
- 28 USB / Infotainment
- 31 Airbag

**No. Circuit**

- 33 Power outlet front
- 36 Infotainment

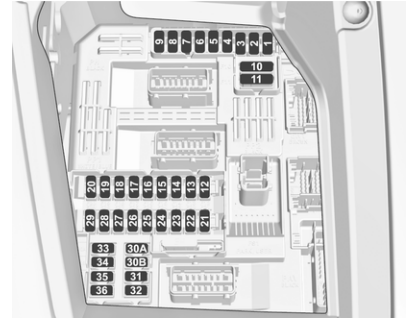

**No. Circuit**

- 1 Interior mirror / Electrical power steering wheel / Selective ride control / Radar / Diesel exhaust system
- 3 Trailer provisions control module
- 4 Horn

**No. Circuit**

- 5 Windscreen washer
- 6 Windscreen washer
- 7 Power outlet rear
- 10 Doors lock / Tailgate lock
- 11 Doors lock / Tailgate lock
- 12 Stop-start system / Diagnostic connector module / Brake system
- 13 Infotainment / Climate control system
- 14 Alarm siren
- 15 Climate control system
- 16 Stop-start system / Brake system
- 17 Driver Information Centre
- 19 Column electrical assembly / Steering wheel controls
- 21 Anti-theft alarm system

**No. Circuit**

- 22 Camera / Rain sensor / Automatic light control
- 23 Seat belt reminder
- 24 Automatic transmission / Advanced parking assist / Panoramic view system
- 25 Airbag
- 26 Electronic Stability Control
- 27 Alarm
- 28 BTA module
- 29 Infotainment
- 32 Cigarette lighter / Power outlet front
- 34 Heated rear window / Heated windscreen / Inductive charging
- 35 Light switch / Diagnostic connector module
- 36 Lighting

**Vehicle tools**

**Tools**

**Vehicles with spare wheel**

Open the floor cover of the load compartment ↷ 58.

Remove the cover of the tool box.

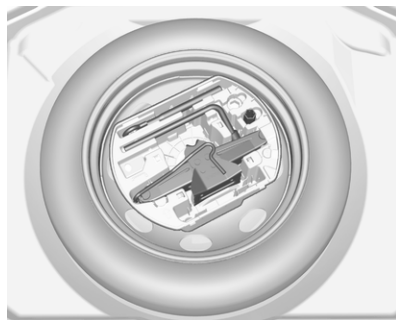

The jack, the towing eye, chocks and the tools are located in the tool box.

## Vehicles without spare wheel

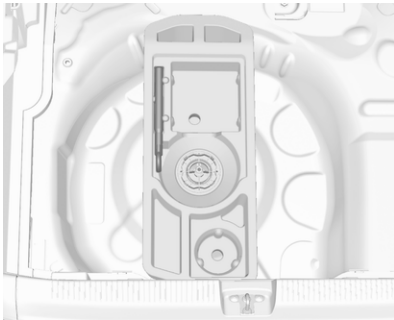

The towing eye and the chocks are located in a box below the floor cover in the load compartment.

Tyre repair kit ⇨ 225.

## Vehicles with audio speaker system

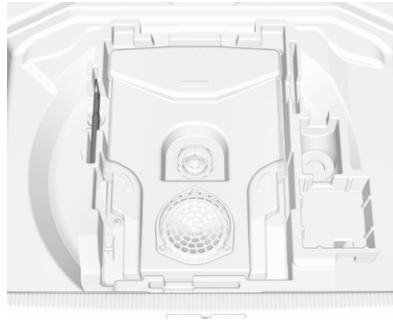

The towing eye and the chocks are located in a box below the floor cover in the load compartment.

Tyre repair kit ⇨ 225.

## Wheels and tyres

### Tyre condition, wheel condition

Drive over edges slowly and at right angles if possible. Driving over sharp edges can cause tyre and wheel damage. Do not trap tyres on the kerb when parking.

Regularly check the wheels for damage. Seek the assistance of a workshop in the event of damage or unusual wear.

### Winter tyres

Winter tyres improve driving safety at temperatures below 7 °C and should therefore be fitted on all wheels.

In accordance with country-specific regulations, affix the speed sticker in the driver's field of view.

All tyre sizes are permitted as winter tyres ⇨ 256.

## Tyre designations

E.g. **225/55 R 18 98 V**

**225** : tyre width, mm

**55** : cross-section ratio (tyre height to tyre width), %

**R** : belt type: Radial

**RF** : type: RunFlat

**18** : wheel diameter, inches

**98** : load index e.g. 98 is equivalent to 750 kg

**V** : speed code letter

Speed code letter:

**Q** : up to 100 mph

**S** : up to 112 mph

**T** : up to 118 mph

**H** : up to 130 mph

**V** : up to 150 mph

**W** : up to 168 mph

Choose a tyre appropriate for the maximum speed of your vehicle.

The maximum speed is achievable at kerb weight with driver (75 kg) plus 125 kg payload. Optional equipment could reduce the maximum speed of the vehicle.

Performance ⇨ 253.

## Directional tyres

Directional tyres should be mounted so that they rotate in the correct direction. The proper rotation direction is indicated by a symbol (e.g. an arrow) on the sidewall.

## Tyre pressure

Check the pressure of cold tyres at least every 14 days and before any long journey. Do not forget the spare wheel. This also applies to vehicles with tyre pressure monitoring system.



Tyre pressure ⇨ 256.

The tyre pressure information label on the left door frame indicates the original equipment tyres and the correspondent tyre pressures.

The tyre pressure data refers to cold tyres. It applies to summer and winter tyres.

Always inflate the spare tyre to the pressure specified for full load.

Incorrect tyre pressures will impair safety, vehicle handling, comfort and fuel economy and will increase tyre wear.

Tyre pressures differ depending on various options. For the correct tyre pressure value, follow the procedure below:

1. Identify the engine identifier code.  
Engine data ⇨ 251.
2. Identify the respective tyre.

The tyre pressure tables show all possible tyre combinations ⇨ 256.

For the tyres approved for your vehicle, refer to the EEC Certificate of Conformity provided with your vehicle or other national registration documents.



The driver is responsible for correct adjustment of tyre pressure.

### **⚠ Warning**

If the pressure is too low, this can result in considerable tyre warm-up and internal damage, leading to tread separation and even to tyre blow-out at high speeds.

### **⚠ Warning**

For specific tyres the recommended tyre pressure as shown in the tyre pressure table may exceed the maximum tyre pressure as indicated on the tyre. Never exceed the maximum tyre pressure as indicated on the tyre.

## **Temperature dependency**

The tyre pressure depends on the temperature of the tyre. During driving, tyre temperature and pressure increase. Tyre pressure values provided on the tyre

information label and tyre pressure chart are valid for cold tyres, which means at 20 °C.

The pressure increases by nearly 1.5 psi for a 10 °C temperature increase. This must be considered when warm tyres are checked.

## **Tyre deflation detection system**

The tyre deflation detection system continually checks the rotation speed of all four wheels and warns on low tyre pressure condition once vehicle is driving. This is achieved by comparing tyre rolling circumference with reference values and further signals.

If a tyre loses pressure the control indicator (⚠) illuminates and a warning message is displayed in the Driver Information Centre.

Control indicator (⚠) ⇨ 85.

In this case reduce speed, avoid sharp cornering and strong braking. Stop at next safe opportunity and check tyre pressure.

After adjusting tyre pressure initialise system to extinguish the control indicator and restart system.

If the failure continues to be displayed, contact a workshop. The system is inoperable when ABS or ESC has a malfunction or a temporary spare wheel is used. Once the road tyre has been refitted, check the tyre pressure with cold tyres and initialise the system.

### **Caution**

Deflation detection system warns just about low tyre pressure condition and does not replace regular tyre maintenance by the driver.

## **System initialisation**

After tyre pressure correction or wheel change, the system must be initialised to learn new circumference reference values:

1. Always ensure that all four tyres have correct tyre pressure  
⇨ 256.
2. Apply parking brake.
3. Initialise the system via the Info Display ⇨ 88.
4. Reset is confirmed by pop-up indication.

After initialisation system automatically calibrates to new tyre pressures during driving. After longer drive the system will adopt and monitor new pressures.

Always check tyre pressure with cold tyres.

System has to be reinitialised when:

- Tyre pressure has been changed
- Load condition has been changed
- Wheels have been swapped or exchanged

The system will not warn instantaneously on a tyre blow out or a rapid deflation. This is due to required calculation time.

## Tread depth

Check tread depth at regular intervals.

For safety reasons, it is recommended that the tread depth of the tyres on one axle should not vary by more than 2 mm.



The legally permissible minimum tread depth (1.6 mm) has been reached when the tread has worn down as far as one of the tread wear indicators (TWI). Their position is indicated by markings on the sidewall.

If there is more wear at the front than the rear, swap round front wheels and rear wheels periodically. Ensure that the direction of rotation of the wheels remains the same.

Tyres age, even if they are not used. We recommend tyre replacement every 6 years.

## Changing tyre and wheel size

If tyres of a different size than those fitted at the factory are used, it may be necessary to reprogramme the tyre deflation detection system and make other vehicle modifications.

Tyre deflation detection system  
⇨ 223.

Have the label with tyre pressures replaced.

### **⚠ Warning**

The use of unsuitable tyres or wheels may lead to accidents and will invalidate the vehicle operating permit.

## Wheel covers

Wheel covers and tyres that are factory approved for the respective vehicle and comply with all of the relevant wheel and tyre combination requirements must be used.

If the wheel covers and tyres used are not factory approved, the tyres must not have a rim protection ridge.

Wheel covers must not impair brake cooling.

### ⚠ Warning

Use of unsuitable tyres or wheel covers could lead to sudden pressure loss and thereby accidents.

Vehicles with steel wheels: When using locking wheel nuts, do not attach wheel covers.

## Tyre chains

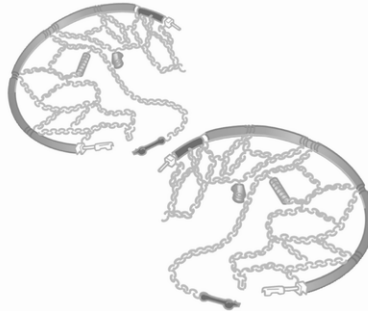

Tyre chains are only permitted on the front wheels.

Always use fine mesh chains that add no more than 9 mm to the tyre tread and the inboard sides (including chain lock).

### ⚠ Warning

Damage may lead to tyre blowout.

Tyre chains are permitted on tyres of size 215/70R16, 215/65 R17, 225/55 R18 and 205/55 R19.

## Temporary spare wheel

The use of tyre chains is not permitted on the temporary spare wheel.

## Tyre repair kit

Minor damage to the tyre tread can be repaired with the tyre repair kit.

Do not remove foreign bodies from the tyres.

Tyre damage exceeding 4 mm or that is at tyre's sidewall cannot be repaired with the tyre repair kit.

### ⚠ Warning

Do not drive faster than 50 mph.  
Do not use for a lengthy period.  
Steering and handling may be affected.

In the case of a flat tyre:

Apply the parking brake and engage first gear, reverse gear or **P**.

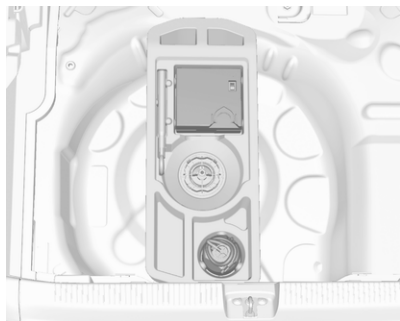

The tyre repair kit is in the load compartment below the floor cover.

1. Remove the sealant bottle and the compressor.
2. Pull speed limit label from sealant bottle and place it in driver's visible area.



3. Remove the electrical connection cable and air hose from the storage compartments on the underside of the compressor.

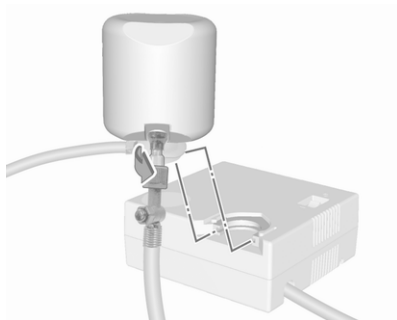

4. Screw the compressor air hose to the connection on the sealant bottle.
5. Fit the sealant bottle into the bracket on the compressor.  
Set the compressor near the tyre in such a way that the sealant bottle is upright.
6. Unscrew valve cap from defective tyre.

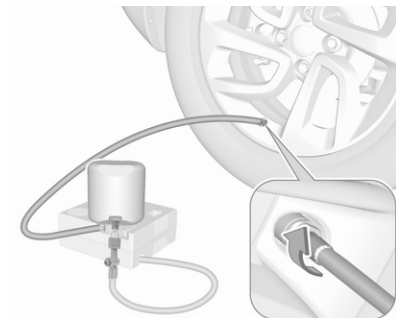

7. Screw the filler hose to the tyre valve.
8. The switch on the compressor must be set to O.

9. Connect the compressor plug to the power outlet or cigarette lighter socket.

The tyre repair kit may only be plugged in to the front 12 V power outlet, in order to work properly.

To avoid discharging the battery, we recommend running the engine.

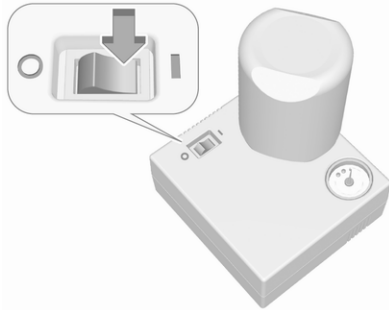

10. Set the rocker switch on the compressor to I. The tyre is filled with sealant.
11. The compressor pressure gauge briefly indicates up to 600 kPa (6 bar) whilst the sealant

bottle is emptying (approx. 30 seconds). Then the pressure starts to drop.

12. All of the sealant is pumped into the tyre. Then the tyre is being inflated.
13. The prescribed tyre pressure should be obtained within 10 minutes.

Tyre pressure ⇨ 256.

When the correct pressure is obtained, switch off the compressor.

If the prescribed tyre pressure is not obtained within 10 minutes, remove the tyre repair kit. Move the vehicle one tyre rotation. Reattach the tyre repair kit and continue the filling procedure for 10 minutes. If the prescribed tyre pressure is still not obtained, the tyre is too badly damaged. Seek the assistance of a workshop.

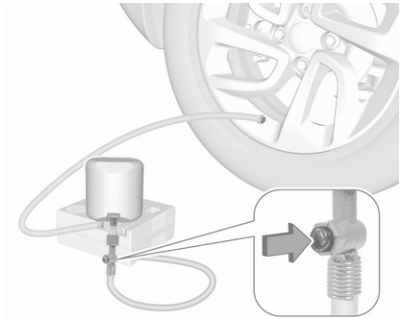

Drain excess tyre pressure with the button on the air hose.

Do not run the compressor longer than 10 minutes.

14. Detach the tyre repair kit. Remove sealant bottle from bracket. Screw the filler hose to the free connection of the sealant bottle. This prevents sealant from escaping. Stow tyre repair kit in load compartment.
15. Remove any excess sealant using a cloth.

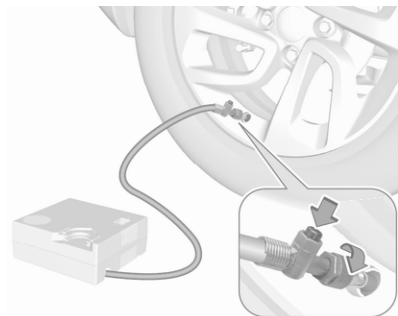

16. Continue driving immediately so that sealant is evenly distributed in the tyre. After driving approx. 3 miles but no more than 10 minutes, stop and check tyre pressure. Screw compressor air hose directly onto tyre valve when doing this. Fill tyre as described before. Drain excess tyre pressure with the button on the air hose.

If tyre pressure hasn't decreased under 150 kPa (1.5 bar), set it to the correct value. Otherwise the vehicle must not be used. Seek assistance of a workshop ↗ 256.

Repeat the checking procedure once more after driving further 6 miles but no more than 10 minutes to check that there is no more loss of pressure.

If the tyre pressure has fallen below 150 kPa (1.5 bar), the vehicle must not be used. Seek the assistance of a workshop.

17. Stow away tyre repair kit in load compartment.

#### Notice

The driving characteristics of the repaired tyre are severely affected, therefore have this tyre replaced.

If unusual noise is heard or the compressor becomes hot, turn compressor off for at least 30 min.

The built-in safety valve opens at a pressure of seven bar (102 psi).

Note the expiry date of the kit. After this date its sealing capability is no longer guaranteed. Pay attention to storage information on sealant bottle.

Replace the used sealant bottle. Dispose of the bottle as prescribed by applicable laws.

The compressor and sealant can be used from approx. -30 °C.

## Wheel changing

Make the following preparations and observe the following information:

- Park the vehicle on a level, firm and non-skid surface. The front wheels must be in the straight-ahead position.
- If necessary, place a chock under the wheel diagonally opposite the wheel to be changed.
- Apply the parking brake and engage first gear, reverse gear or **P**.
- If the ground on which the vehicle is standing is soft, a solid board (max. 1 cm thick) should be placed under the jack.
- Take heavy objects out of the vehicle before jacking up.
- No people or animals may be in the vehicle when it is jacked-up.

- Never crawl under a jacked-up vehicle.
- Do not start the vehicle when it is raised on the jack.
- Before screwing in the wheel bolts, clean them.

### **⚠ Warning**

Do not grease wheel bolts.

### **Tightening torques**

#### **Caution**

If the vehicle is equipped with alloy wheels, tighten the wheel bolts manually at least for the first five turns.

There are two different types of wheels with two different bolts and tightening torques.

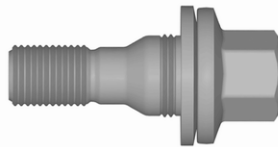

Tightening torque for alloy wheels is 100 Nm.



Tightening torque for steel wheels is 115 Nm.

Use the correct wheel bolts for the respective wheels.

### **Jacking positions**

The jacking positions shown refer to the use of lifting arms and accessory jacks used for changing winter / summer tyres.

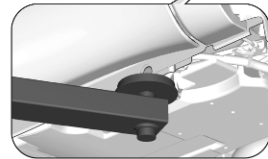

Rear arm position of the lifting platform centrally under the relevant vehicle jacking point.

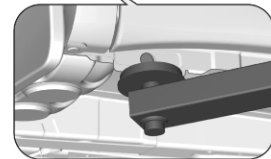

Front arm position of the lifting platform centrally under the relevant vehicle jacking point.

## Spare wheel

The spare wheel can be classified as a temporary spare wheel depending on the size compared to the other mounted wheels and country regulations. In this case a permissible maximum speed applies, even though no label at the spare wheel indicates this.

Only mount one temporary spare wheel. Do not drive faster than 50 mph. Take curves slowly. Do not use for a long period of time.

### Caution

The use of a spare wheel that is smaller than the other wheels or in combination with winter tyres could affect driveability. Have the defective tyre replaced as soon as possible.



The spare wheel is located in the load compartment beneath the floor covering.

To remove:

1. Open the floor cover ⇨ 58.
2. Remove the tool box.
3. The temporary spare wheel is secured with a wing nut. Unscrew nut and take out the spare wheel.

4. When, after a wheel change, no wheel is placed in the spare wheel well, secure the tool box by tightening the wing nut as far as it will go and close floor cover.
5. After wheel change back to full size wheel, place the temporary spare wheel outside up in the well and secure with the wing nut.

Only mount one temporary spare wheel. The permissible maximum speed on the label on the temporary spare wheel is only valid for the factory-fitted tyre size.

## Fitting the spare wheel

Make the following preparations and observe the following information:

- Park the vehicle on a level, firm and non-skid surface. The front wheels must be in the straight-ahead position.
- If necessary, place a chock under the wheel diagonally opposite the wheel to be changed.
- Apply the parking brake and engage first gear, reverse gear or **P**.



- Remove the spare wheel.
- Never change more than one wheel at once.
- Use the jack only to change wheels in case of puncture, not for seasonal winter or summer tyre change.
- The jack is maintenance-free.
- If the ground on which the vehicle is standing is soft, a solid board (max. 1 cm thick) should be placed under the jack.
- Take heavy objects out of the vehicle before jacking up.
- No people or animals may be in the vehicle when it is jacked-up.
- Never crawl under a jacked-up vehicle.
- Do not start the vehicle when it is raised on the jack.
- Before screwing in the wheel bolts, clean them.

**⚠ Warning**

Do not grease wheel bolts.

**⚠ Warning**

Ensure to use always the correct wheel bolts if changing the wheels. When installing the spare wheel, the bolts for alloy wheels can also be used.

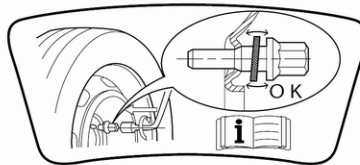

- Note that the spare wheel is secured by the conical contact of each bolt if the wheel bolts for the alloy wheels are used. In this case, the washers do not come into contact with the spare wheel.
1. Disengage wheel bolt caps with the wheel bolt cover remover.

Vehicle tools ↻ 220.

Steel wheels with cover: Pull off the wheel cover.

Alloy wheels: Disengage wheel bolt caps with the wheel bolt cover remover.



2. Attach the wheel wrench and loosen each wheel bolt by half a turn.

The wheels might be protected by locking wheel nuts. To loosen these specific nuts first attach the adapter onto the head of the nut before installing the wheel wrench. The adapter is located in the tool box ↻ 220.



3. Ensure the jack is correctly positioned under the relevant vehicle jacking point.

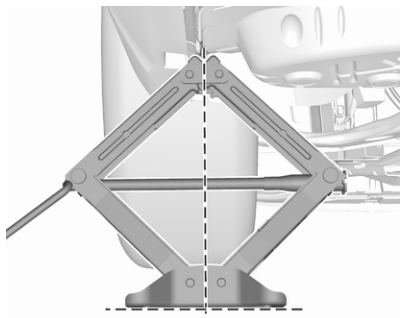

4. Set the jack to the necessary height. Position it directly below

the jacking point in a manner that prevents it from slipping.

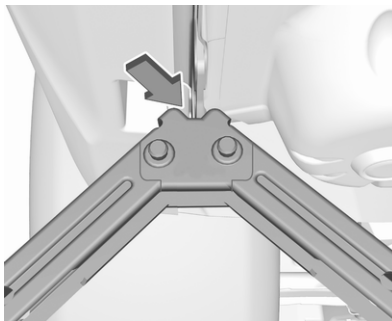

Ensure that the edge of the body fits into the notch of the jack.



With the jack correctly aligned rotate wheel wrench until wheel is clear of the ground.

5. Unscrew the wheel nuts.
6. Change the wheel.
7. Screw on the wheel nuts.
8. Lower the vehicle and remove jack.
9. Install the wheel wrench ensuring that it is located securely and tighten each bolt in a crosswise sequence. Tightening torque is 115 Nm.

If the vehicle is equipped with alloy wheels, note that the wheel bolts can also be used for the steel spare wheel. In this case, the spare wheel is secured by the conical contact of each bolt.

10. Align the valve hole in the wheel cover with the tyre valve before installing.

Install wheel nut caps.

11. Stow the replaced wheel, the vehicle tools ⇨ 220 and the adapter for the locking wheel nuts.
12. Check the tyre pressure of the installed tyre and the wheel nut torque as soon as possible.

### Stowing a damaged full size wheel in the load compartment

All permitted wheel sizes can be stowed in the spare wheel well. To secure the wheel:



1. Remove centre cap with the brand emblem by pushing from the inside.
2. Position the wheel outside down in the wheel well.
3. Secure the defective wheel with the wing nut.
4. Depending on the tyre size, the floor cover can be placed on the projecting wheel.

## Jump starting

Do not start with quick charger.

A vehicle with a discharged vehicle battery can be started using jump leads and the vehicle battery of another vehicle.

### Caution

Never jump start another vehicle with a hybrid vehicle.

### ⚠ Warning

Be extremely careful when starting with jump leads. Any deviation from the following instructions can lead to injuries or damage caused by battery explosion or damage to the electrical systems of both vehicles.

### ⚠ Warning

Avoid contact of the battery with eyes, skin, fabrics and painted surfaces. The fluid contains sulphuric acid which can cause injuries and damage in the event of direct contact.

- Never expose the vehicle battery to naked flames or sparks.
- A discharged vehicle battery can already freeze at a temperature of 0 °C. Defrost the frozen battery before connecting jump leads.
- Wear eye protection and protective clothing when handling a battery.
- Use a booster battery with the same voltage (12 V). Its capacity (Ah) must not be much less than that of the discharged vehicle battery.
- Use jump leads with insulated terminals and a cross section of at least 16 mm<sup>2</sup> (25 mm<sup>2</sup> for diesel engines).

- Do not disconnect the discharged vehicle battery from the vehicle.
- Switch off all unnecessary electrical consumers.
- Do not lean over the vehicle battery during jump starting.
- Do not allow the terminals of one lead to touch those of the other lead.
- The vehicles must not come into contact with each other during the jump starting process.
- Apply the parking brake, transmission in neutral, automatic transmission in **P**.

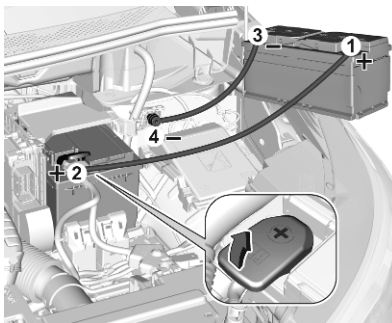

Open the positive terminal protection caps of both vehicle batteries.

Lead connection order:

1. Connect the red lead to the positive terminal of the booster battery.
2. Connect the other end of the red lead to the positive terminal of the discharged battery.
3. Connect the black lead to the negative terminal of the booster battery.
4. Connect the other end of the black lead to the vehicle grounding point of your vehicle in the engine compartment.

Route the leads so that they cannot catch on rotating parts in the engine compartment.

To start the engine:

1. Start the engine of the vehicle providing the jump.
2. After 5 minutes, start the other engine. Start attempts should be made for no longer than 15 seconds at an interval of 1 minute.

3. Allow both engines to idle for approx. 3 minutes with the leads connected.
4. Switch on electrical consumers e.g. headlights, heated rear window of the vehicle receiving the jump start.
5. Reverse above sequence exactly when removing leads.

## Towing

### Towing the vehicle



Remove the cap.

The towing eye is stowed with the vehicle tools ↗ 220.

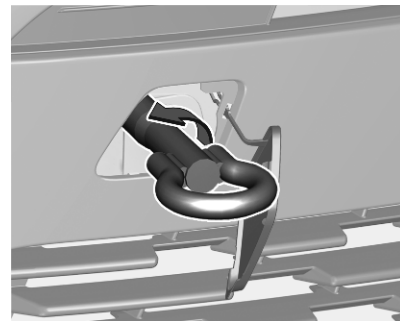

Screw in the towing eye as far as it will go until it stops in a horizontal position.

Attach a tow rope – or better still a tow rod – to the towing eye.

The towing eye must only be used for towing and not for recovering the vehicle.

Switch on ignition to release steering wheel lock and to permit operation of brake lights, horn and windscreen wiper.

**Caution**

Deactivate the driver assistance systems like active emergency braking ↪ 157, otherwise the vehicle may automatically brake during towing.

Switch the selector lever to neutral.  
Release the parking brake.

**Caution**

Drive slowly. Do not drive jerkily. Excessive tractive force can damage the vehicle.

When the engine is not running, considerably more force is needed to brake and steer.

To prevent the entry of exhaust gases from the towing vehicle, switch on the air recirculation and close the windows.

Vehicles with automatic transmission: The vehicle must be towed facing forwards, not faster than 50 mph nor further than 60 miles. In all other

cases and when the transmission is defective, the front axle must be raised off the ground.

Seek the assistance of a workshop.  
After towing, unscrew the towing eye.  
Insert cap with the flange into the recess and fix cap by pushing.

**Towing a hybrid vehicle****⚠ Warning**

Always tow the vehicle on a platform. Avoid towing the vehicle with two or four wheels on the ground.

If necessary, the vehicle can be moved a few metres at a speed below 6 mph.

Before moving the car: Switch on ignition, depress the brake pedal, shift to **N** and switch off ignition.

Ensure the vehicle is only towed by well trained technicians.

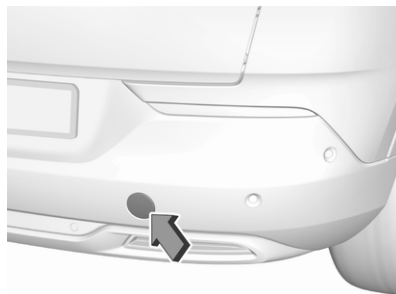
**Towing another vehicle**

Remove the cap.

The towing eye is stowed with the vehicle tools ↪ 220.

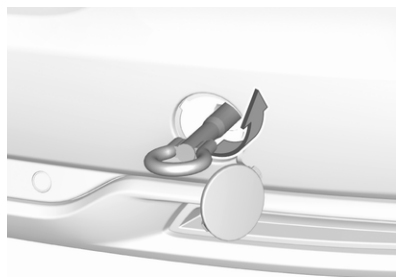

Screw in the towing eye as far as it will go until it stops in a horizontal position.

The lashing eye at the rear underneath the vehicle must never be used as a towing eye.

Attach a tow rope – or better still a tow rod – to the towing eye.

The towing eye must only be used for towing and not for recovering a vehicle.

**Caution**

Drive slowly. Do not drive jerkily. Excessive tractive force can damage the vehicle.

After towing, unscrew the towing eye. Insert cap with the upper flange into the recess and fix cap by pushing.

**Appearance care**

**Exterior care**

**Locks**

The locks are lubricated at the factory using a high quality lock cylinder grease. Use a de-icing agent only when absolutely necessary, as this has a degreasing effect and impairs lock function. After using a de-icing agent, have the locks regreased by a workshop.

**Washing**

The paintwork of your vehicle is exposed to environmental influences.

Bird droppings, dead insects, resin, pollen and the like should be cleaned off immediately, as they contain aggressive constituents which can cause paint damage.

If using a vehicle wash, comply with the vehicle wash manufacturer's instructions. The windscreen wiper and rear window wiper must be

switched off. Remove antenna and external accessories such as roof racks etc.

If you wash your vehicle by hand, make sure that the insides of the wheel housings are also thoroughly rinsed out.

Wax painted parts of the vehicle regularly.

Clean edges and folds on opened doors and the bonnet as well as the areas they cover.

Clean bright metal mouldings with a cleaning solution approved for aluminium to avoid damages.

**Caution**

Always use a cleaning agent with a pH value of 4 to 9. Do not use cleaning agents on hot surfaces.

Do not clean the engine compartment with a steam-jet or high-pressure jet cleaner.

Thoroughly rinse and leather-off the vehicle. Rinse leather frequently. Use separate leathers for painted and glass surfaces: remnants of wax on the windows will impair vision.

Have the door hinges of all doors greased by a workshop.

### **Exterior lights**

Headlight and other light covers are made of plastic. Do not use any abrasive or caustic agents, do not use an ice scraper, and do not clean them dry.

### **Polishing and waxing**

Polishing is necessary only if the paint has become dull or if solid deposits have become attached to it.

Plastic body parts must not be treated with wax or polishing agents.

### **Windows and wiper blades**

Switch off wipers before handling in their areas.

Use a soft lint-free cloth or chamois leather together with window cleaner and insect remover.

When cleaning the rear window from inside, always wipe in parallel to the heating element to prevent damage.

For mechanical removal of ice, use a sharp-edged ice scraper. Press the scraper firmly against the glass so that no dirt can get under it and scratch the glass.

Clean smearing wiper blades with a soft cloth and window cleaner. Also make sure to remove any residues such as wax, insect residues and similar from the window.

Ice residues, pollution and continuous wiping on dry windows will damage or even destroy the wiper blades.

### **Glass panel**

Use a soft lint-free cloth or chamois leather together with window cleaner to clean the glass panel.

### **Wheels and tyres**

Do not use high-pressure jet cleaners.

Clean rims with a pH-neutral wheel cleaner.

Rims are painted and can be treated with the same agents as the body.

### **Paintwork damage**

Rectify minor paintwork damage with a touch-up pen before rust forms. Have more extensive damage or rust areas repaired by a workshop.

### **Underbody**

Some areas of the vehicle underbody have a PVC undercoating while other critical areas have a durable protective wax coating.

After the underbody is washed, check the underbody and have it waxed if necessary.

Bitumen / rubber materials could damage the PVC coating. Have underbody work carried out by a workshop.

Before and after winter, wash the underbody and have the protective wax coating checked.



## Liquid gas system

### Danger

Liquid gas is heavier than air and can collect in sink points.

Take care when performing work at the underbody in a pit.

For painting work and when using a drying booth at a temperature above 60 °C, the liquid gas tank must be removed.

Do not make any modifications to the liquid gas system.

## Towing equipment

Do not clean the coupling ball bar with a steam-jet or high-pressure jet cleaner.

## Interior care

### Interior and upholstery

Only clean the vehicle interior, including the instrument panel fascia and panelling, with a dry cloth or interior cleaner.

Clean the leather upholstery with clear water and a soft cloth. In case of heavy soiling, use leather care.

The Driver Information Centre and the displays should only be cleaned using a soft damp cloth. If necessary use a weak soap solution.

Clean fabric upholstery with a vacuum cleaner and brush. Remove stains with an upholstery cleaner.

Clothing fabrics may not be colourfast. This could cause visible discolourations, especially on light-coloured upholstery. Removable stains and discolourations should be cleaned as soon as possible.

Clean seat belts with lukewarm water or interior cleaner.

### Caution

Close Velcro fasteners and open Velcro fasteners on clothing could damage seat upholstery.

The same applies to clothing with sharp-edged objects, e.g. zips, belts or studded jeans.

## Plastic and rubber parts

Plastic and rubber parts can be cleaned with the same cleaner as used to clean the body. Use interior cleaner if necessary. Do not use any other agent. Avoid solvents and petrol in particular. Do not use high-pressure jet cleaners.

## Floor mats

### Warning

If a floor mat has the wrong size or is not properly installed, it can interfere with the accelerator pedal and/or brake pedal, what can cause unintended acceleration and/or increased stopping distance which can cause a crash and injury.

Use the following guidelines for proper floor mat usage.

- The original equipped floor mats were designed for your vehicle. Have damaged floor mats only

replaced by certified floor mats. Always check that the floor mats do not interfere with the pedals.

- Use the floor mat with the correct side up. Do not turn it over.
- Do not place anything on top of the driver's side floor mat.
- Use only a single floor mat on the driver's side.

### Installing and removing the floor mats

The driver's side floor mat and the passenger's side floor mat are each held in place by two retainers.

To install the floor mat:

1. Move the seat backwards as far as possible.

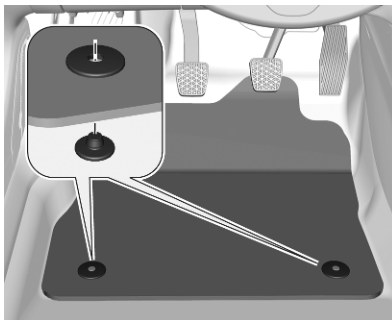

2. Align slots in the mat with the retainers, as shown.
3. Push the mat to the floor.

To remove the floor mat:

1. Move the seat backwards as far as possible.
2. Pull the floor mat upwards to remove.

## Service and maintenance

<b>General information</b> .....	<b>241</b>
Service information .....	241
<b>Recommended fluids, lubricants and parts</b> .....	<b>245</b>
Recommended fluids and lubricants .....	245

## General information

### Service information

In order to ensure economical and safe vehicle operation and to maintain the value of your vehicle, it is of vital importance that all maintenance work is carried out at the proper intervals as specified.

The detailed, up-to-date service schedule for your vehicle is available at the workshop.

Severe operating conditions exist if one or more of the following circumstances occur frequently: Cold starting, stop and go operation, e.g. for taxis and police vehicles, trailer operation, mountain driving, driving on poor and sandy road surfaces, increased air pollution, presence of airborne sand and high dust content, driving at high altitude and large variations of temperature.

Under these severe operating conditions, certain service work may be required more frequently than the regular service interval indicated in the service display. Contact a workshop for customised service schedules.

Service display ⇨ 77.

### Confirmations

Confirmation of service is recorded in the Service and warranty booklet. The date and mileage is completed with the stamp and signature of the servicing workshop.

Make sure that the Service and warranty booklet is completed correctly as continuous proof of service is essential if any warranty or goodwill claims are to be met, and is also a benefit when selling the vehicle.

## 242 Service and maintenance

---

### Service intervals

Engine code	EB2ADT EB2ADTS	EB2FA	EP6FADTXD (Hybrid version)	EB2DTS	EP6FDTMD EP6FDTM
Country group 1	12,000 miles / 1 year	12,000 miles / 1 year	19,000 miles / 1 year		
Country group 2	9,000 miles / 1 year	12,000 miles / 1 year	12,000 miles / 1 year		
Country group 3	9,000 miles / 1 year	12,000 miles / 1 year	12,000 miles / 1 year	6,000 miles / 1 year <sup>1)</sup>	
Country group 4	9,000 miles / 1 year	9,000 miles / 1 year	12,000 miles / 1 year		12,000 miles / 1 year
Country group 5		6,000 miles / 1 year			6,000 miles / 1 year

---

1) Unless otherwise indicated in the service display.

Engine code	DV5RC DV5RD DV5RCD DV5RCE	DW10FC	DV6D
Country group 1	19,000 miles / 1 year <sup>1)</sup>	19,000 miles / 1 year <sup>1)</sup>	
Country group 2	19,000 miles / 1 year <sup>1)</sup>	19,000 miles / 1 year <sup>1)</sup>	
Country group 3	9,000 miles / 1 year	12,000 miles / 1 year	
Country group 4	9,000 miles / 1 year	12,000 miles / 1 year	9,000 miles / 1 year
Country group 5	6,000 miles / 1 year	6,000 miles / 1 year	6,000 miles / 1 year

1) Unless otherwise indicated in the service display.

#### Country Group 1:

Andorra, Austria, Belgium, Cyprus, Denmark, Finland, France, Germany, Greece, Iceland, Republic of Ireland, Italy, Liechtenstein, Luxembourg, Malta, Monaco, Netherlands, Norway, Portugal, San Marino, Spain, Sweden, Switzerland, United Kingdom.

#### Country Group 2:

Bosnia-Herzegovina, Bulgaria, Croatia, Czech Republic, Estonia, North Macedonia, Hungary, Latvia, Lithuania, Poland, Romania, Slovakia, Slovenia.

#### Country Group 3:

Albania, Montenegro, Serbia.

#### Country Group 4:

Israel, South Africa, Turkey, Lesotho, Swaziland.

### **Country Group 5:**

All other countries which are not listed in the previous country groups.

### **Confirmations**

Confirmation of service is recorded in the Service and warranty booklet. The date and mileage is completed with the stamp and signature of the servicing workshop.

Make sure that the Service and warranty booklet is completed correctly as continuous proof of service is essential if any warranty or goodwill claims are to be met, and is also a benefit when selling the vehicle.

## Recommended fluids, lubricants and parts

### Recommended fluids and lubricants

Only use products that meet the recommended specifications.

#### Warning

Operating materials are hazardous and could be poisonous. Handle with care. Pay attention to information given on the containers.

### Engine oil

Engine oil is identified by its quality and its viscosity. Quality is more important than viscosity when selecting which engine oil to use. The engine oil quality ensures e.g. engine cleanliness, wear protection and engine oil aging control, whereas viscosity grade gives information on the engine oil's thickness over a temperature range.

Select the appropriate engine oil based on its quality and on the minimum ambient temperature ⇨ 249.

### Topping up engine oil

#### Caution

In case of any spilled engine oil, wipe it up and dispose of it properly.

Engine oils of different manufacturers and brands can be mixed as long as they comply with the required engine oil quality and viscosity.

Use of engine oils for all petrol engines with only ACEA quality is prohibited, since it can cause engine damage under certain operating conditions.

Select the appropriate engine oil based on its quality and on the minimum ambient temperature ⇨ 249.

### Additional engine oil additives

The use of additional engine oil additives could cause damage and invalidate the warranty.

### Engine oil viscosity grades

The SAE viscosity grade gives information of the thickness of the engine oil.

Multigrade engine oil is indicated by two figures, e.g. SAE 5W-30. The first figure, followed by a W, indicates the low temperature viscosity and the second figure the high temperature viscosity.

Select the appropriate viscosity grade depending on the minimum ambient temperature ⇨ 249.

All of the recommended viscosity grades are suitable for high ambient temperatures.

### Coolant and antifreeze

Use only Lobrid antifreeze approved for the vehicle. Consult a workshop.

The system is factory filled with coolant designed for excellent corrosion protection and frost protection down to approx. -28 °C. In

cold regions with very low temperatures the factory filled coolant provides frost protection down to approx. -37 °C. This concentration should be maintained all year round. The use of additional coolant additives that intend to give additional corrosion protection or seal against minor leaks can cause function problems. Liability for consequences resulting from the use of additional coolant additives will be rejected.

### **Washer fluid**

Use only washer fluid approved for the vehicle to prevent damage of wiper blades, paintwork, plastic and rubber parts. Consult a workshop.

### **Brake and clutch fluid**

Over time, brake fluid absorbs moisture which will reduce braking effectiveness. The brake fluid should therefore be replaced at the specified interval.

### **AdBlue**

Only use AdBlue to reduce the nitrogen oxides in the exhaust emission ↗ 124.



## Technical data

<b>Vehicle identification</b> .....	<b>247</b>
Vehicle identification number ..	247
Identification plate .....	247
Engine identification .....	248
<b>Vehicle data</b> .....	<b>249</b>
Recommended fluids and lubricants .....	249
Engine data .....	251
Performance .....	253
Vehicle dimensions .....	254
Capacities .....	255
Tyre pressures .....	256

## Vehicle identification

### Vehicle identification number



The Vehicle Identification Number may be embossed on the instrument panel, visible through the windscreen, or in the engine compartment on the right body panel.

## Identification plate



The identification plate is located on the front left or right door frame.

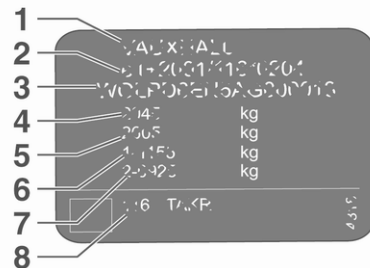

Information on identification label:

- 1** : manufacturer
- 2** : type approval number
- 3** : vehicle identification number
- 4** : permissible gross vehicle weight rating in kg
- 5** : permissible gross train weight in kg
- 6** : maximum permissible front axle load in kg
- 7** : maximum permissible rear axle load in kg
- 8** : manufacturer address, vehicle-specific or country-specific data

The combined total of front and rear axle loads must not exceed the permissible gross vehicle weight.

Vehicle's kerb weight depends on the specification of the vehicle, e.g. optional equipment and accessories. Refer to the EEC Certificate of Conformity provided with your vehicle or other national registration documents.

The technical data is determined in accordance with European Community standards. We reserve the right to make modifications.

Specifications in the vehicle documents always have priority over those given in this manual.

## **Engine identification**

The technical data tables show the engine identifier code.

Engine data ⇨ 251.

To identify the respective engine, refer to the engine power in the EEC Certificate of Conformity provided with your vehicle or other national registration documents.

## Vehicle data

### Recommended fluids and lubricants

#### Required engine oil quality

Country groups ⇨ 241

#### Countries included in country groups 1 to 3

	EB2FA	EP6FDTM
	EB2ADT	EB2DT
	EB2ADTS	EC5F
	EP6FADTXD	DW10FC
	DV5RC	DV6D
	DV5RD	DV6FD
	DV5RE	DV6FE
<b>Vauxhall Original engine oil</b>	B71 2010 / B71 2312	B71 2312

Engine EC5F: B71 2290, B71 2296 or B71 300 may also be used.

#### Countries included in country group 4

	<b>all engines</b>
<b>Vauxhall Original engine oil</b>	B71 2302 / B71 2297

Engine EC5F: B71 2296 or B71 300 may also be used.

## 250 Technical data

---

Countries included in country group 5

all engines

---

Vauxhall Original engine oil

B71 2297

---

### Engine oil viscosity grades

Country groups ↗ 241

**B71 2010**

**B71 2312**

**B71 2302**

**B71 2297**

---

Engine oil viscosity grade

SAE 0W-20

SAE 0W-30

SAE 0W-30

SAE 5W-30

---

## Engine data

Engine identifier code	D12xHT / F12xHT	A16xHL	A16NHT	D16xHT
Sales designation	1.2 Turbo	1.6	1.6	1.6
Engineering code	EB2ADTS	EP6FDTMD	EP6FDTM	EP6FADTXD
Piston displacement [cm <sup>3</sup> ]	1200	1598	1598	1598
Engine power [kW]	96	110	121	133
at rpm	5500	6000	6000	5500
Torque [Nm]	230	240	240	250
at rpm	1750	1400	1400	1750
Fuel type	Petrol	Petrol	Petrol	Petrol
Octane rating RON <sup>1)2)</sup>				
recommended	95	95	95	95
possible	98	98	98	98
possible	91	91	91	91
Additional fuel type	–	–	–	–

1) A country specific label at the fuel filler flap can supersede the engine specific requirement.

2) In certain countries, the use of a particular fuel, e.g. a specific octane rating, may be required to ensure proper engine operation.

## 252 Technical data

Engine identifier code	D15DTH	F16XHR	— <sup>3)</sup>	— <sup>3)</sup>	Electric engine (front axle)	Electric engine (rear axle)
Sales designation	1.5	1.6 Turbo	1.6 Turbo	1.6 Turbo	-	-
Engineering code	DV5RC	EP6FADTXD	EP6TFADXHPA	EP6FADTXHPD	-	-
Piston displacement [cm <sup>3</sup> ]	1499	1598	1598	1598	-	-
Engine power [kW]	96	133	147	133	81.2	83
at rpm	3750	5500	600	600	2500	14000
Torque [Nm]	300	250	300	300	320	166
at rpm	1750	3650	3000	3000	500-2500	0-4760
Fuel type	Diesel	Petrol	Petrol	Petrol	-	-
Octane rating RON <sup>4)5)</sup>						
recommended		95			-	-
possible		98			-	-
possible		91			-	-
Additional fuel type		-			-	-

3) Not available at time of printing.

4) A country specific label at the fuel filler flap can supersede the engine specific requirement.

5) In certain countries, the use of a particular fuel, e.g. a specific octane rating, may be required to ensure proper engine operation.

## Performance

Engine	D12xHT / F12xHT	D16xHT	D15DTH	D20DTH	A16NHT	F16XHR	A16xHL
Maximum speed [mph]							
Manual transmission	117	–	121	–	–	–	–
Automatic transmission	121	6)	118	133	125	146	6)

6) Not available at time of printing.

**Vehicle dimensions**

Length [mm]	4478
Width without exterior mirrors [mm]	1841
Width with two exterior mirrors folded [mm]	1970
Width with two exterior mirrors [mm]	2098
Height (without antenna) [mm]	1623
Length of load compartment floor [mm]	876
Length of load compartment with folded second row [mm]	1869
Load compartment width [mm]	1053
Load compartment height at tailgate [mm]	997
Wheelbase [mm]	2675
Turning circle diameter [m]	10.5

---



## Capacities

### Engine oil

Engine	B12xHT	D16XHT	A16DTH	D15DT	D15DTH	D20DTH	A16NHT
including filter [l]	3.5	4.25	3.75	3.95	3.95	5.2	4.25
between MIN and MAX [l]	1.0	<sup>7)</sup>	1.5	1.6	1.6	1.2	1.2

<sup>7)</sup> Not available at time of printing.

### Fuel tank

Petrol / diesel, refilling quantity [l]	53
Petrol (hybrid vehicle), refilling quantity [l]	43

### AdBlue tank

AdBlue, refilling quantity [l]	17
--------------------------------	----

### High voltage battery

Battery capacity [kWh]	13,2
------------------------	------

## Tyre pressures

Engine	Tyres	Vehicle with up to 3 people		With full load	
		front	rear	front	rear
		[kPa/bar] ([psi])	[kPa/bar] ([psi])	[kPa/bar] ([psi])	[kPa/bar] ([psi])
EB2DTS, EB2DTSM, EB2ADTS, EB2DTS, DV5RC, EP6FDT, EP6FDTM, EP6FDTMD	205/55 R19 97V (XL)	240/2.4 (35)	240/2.4 (35)	270/2.7 (39)	310/3.1 (45)
EP6FADTXHP		260/2.6 (38)	270/2.7 (39)	290/2.9 (42)	350/3.5 (51)
EB2DTS, EB2DTSM, EB2ADTS, EB2DTS, DV5RC, EP6FDT, EP6FDTM, EP6FDTMD	215/65 R17 99V (NL)	210/2.1 (30)	210/2.1 (30)	230/2.3 (33)	240/2.4 (35)

Engine	Tyres	Vehicle with up to 3 people		With full load	
		front	rear	front	rear
		[kPa/bar] ([psi])	[kPa/bar] ([psi])	[kPa/bar] ([psi])	[kPa/bar] ([psi])
EB2DTS, EB2DTSM, EB2ADTS, EB2DTS, DV5RC, EP6FDT, EP6FDTM, EP6FDTMD	215/65 R17 103V (XL) Classe A	210/2.1 (30)	210/2.1 (30)	240/2.4 (35)	280/2.8 (41)
EB2DTS, EB2DTSM, EB2ADTS, EB2DTS, DV5RC, EP6FDT, EP6FDTM, EP6FDTMD	215/70 R16 100H (NL)	210/2.1 (30)	210/2.1 (30)	240/2.4 (35)	280/2.8 (41)

**258 Technical data**

---

Engine	Tyres	Vehicle with up to 3 people		With full load	
		front	rear	front	rear
		[kPa/bar] ([psi])	[kPa/bar] ([psi])	[kPa/bar] ([psi])	[kPa/bar] ([psi])
EB2DTS, EB2DTSM, EB2ADTS, EB2DTS, DV5RC EP6FDT, EP6FDTM, EP6FDTMD	225/55 R18 98V (NL)	210/2.1 (30)	210/2.1 (30)	250/2.5 (36)	290/2.9 (42)
EB2DTS, EB2DTSM, EB2ADTS, EB2DTS, DV5RC, EP6FDT, EP6FDTM, EP6FDTMD	225/55 R18 98V M+S (NL)	220/2.2 (32)	220/2.2 (32)	250/2.5 (36)	290/2.9 (42)
EP6FADTXHPA (AWD)		230/2.3 (33)	240/2.4 (35)	240/2.4 (35)	340/3.4 (49)
EP6FADTXHPD (FWD)		230/2.3 (33)	240/2.4 (35)	240/2.4 (35)	320/3.2 (46)

Engine	Tyres	Vehicle with up to 3 people		With full load	
		front	rear	front	rear
		[kPa/bar] ([psi])	[kPa/bar] ([psi])	[kPa/bar] ([psi])	[kPa/bar] ([psi])
EB2DTS, EB2DTSM, EB2ADTS, EB2DTS, DV5RC EP6FDTM, EP6FDTMD	225/55 R18 102V (XL) Classe A	230/2.3 (33)	230/2.3 (33)	270/2.7 (39)	310/3.1 (45)
EP6FADTXHPA (AWD)		230/2.3 (33)	240/2.4 (35)	240/2.4 (35)	340/3.4 (49)
EP6FADTXHPD (FWD)		230/2.3 (33)	240/2.4 (35)	240/2.4 (35)	320/3.2 (46)
EB2DTS, EB2DTSM, EB2ADT, EB2DTS, DV5RC, EP6FDTM, EP6FDTMD	225/55 R18 102V 3PMSF (XL)	220/2.2 (32)	220/2.2 (32)	250/2.5 (36)	290/2.9 (42)
EP6FADTXHPA (AWD)		230/2.3 (33)	240/2.4 (35)	240/2.4 (35)	340/3.4 (49)

**260 Technical data**

---

Engine	Tyres	Vehicle with up to 3 people		With full load	
		front	rear	front	rear
		[kPa/bar] ([psi])	[kPa/bar] ([psi])	[kPa/bar] ([psi])	[kPa/bar] ([psi])
EP6FADTXHPD (FWD)		230/2.3 (33)	240/2.4 (35)	240/2.4 (35)	320/3.2 (46)
EB2DTS, EB2DTSM, EB2ADT, EB2DTS,	235/50 R19 99V (NL)	220/2.2 (32)	210/2.1 (30)	250/2.5 (36)	290/2.9 (42)
DV5RC, EP6FDTM, EP6FDTMD		220/2.2 (32)	220/2.2 (32)	250/2.5 (36)	290/2.9 (42)
All	Temporary spare wheel 135/80 R18	420/4.2 (60)	420/4.2 (60)	420/4.2 (60)	420/4.2 (60)

---

## Customer information

<b>Customer information</b> .....	<b>261</b>
Declaration of conformity .....	261
REACH .....	263
Collision damage repair .....	263
Software update .....	263
Registered trademarks .....	264
<b>Vehicle data recording and privacy</b> .....	<b>265</b>
Event data recorders .....	265
Radio Frequency Identification (RFID) .....	268

## Customer information

### Declaration of conformity

#### Radio transmission systems

This vehicle has systems that transmit and / or receive radio waves subject to Directive 2014/53/EU and The Radio Equipment Regulations 2017 by the United Kingdom. The manufacturers of the systems listed below declare conformity with Directive 2014/53/EU and The Radio Equipment Regulations 2017. The full text of the EU declaration of conformity for each system is available at the following internet address: [www.opel.com/conformity](http://www.opel.com/conformity).

Importer is Vauxhall Motors Limited, MP UK 1-101-135, Chalton House, Luton Road, Chalton, Luton, Bedfordshire, LU4 9TT, United Kingdom.

#### Navi 5.0 IntelliLink

Continental

LCIE Bureau Veritas-Site de Fontenay aux Roses, 33 avenue du général Leclerc, 92260 Fontenay aux Roses, France

Operation frequency (MHz)	Maximum output (dBm)
---------------------------	----------------------

2400.0 - 2483.5	2.2
-----------------	-----

2400.0 - 2483.5	15
-----------------	----

#### Infotainment system R 4.0 IntelliLink

LG Electronics

European Shared Service center B.V.  
Krijgsman 1, 1186 DM Amstelveen,  
The Netherlands

Operation frequency:  
2400.0 - 2483.5 MHz

Maximum output: 4 dBm

#### Infotainment system R 4.0

Clarion

244 rue du Pré à Varois, 54670  
Custines, France

Operation frequency:  
2400 - 2480 MHz

Maximum output: 4 dBm

**BTA Module**

Magneti Marelli S.p.A.  
 Viale A. Borletti 61/63, 20011  
 Corbetta, Italy

Operation frequency (MHz)	Maximum output (dBm)
880 -915	33
1710 - 1785	24
1850 -1910	24
1920 - 1980	24
2500 - 2570	23

**Antenna module**

Laird  
 Daimlerring 31, 31135 Hildesheim,  
 Germany  
 Operation frequency: N/A  
 Maximum output: N/A  
 ASK Automotive Pvt. Ltd.  
 Unit 2 Plot No. 30-31, Fathepur-  
 Nawada, Manesar, Gurugram,  
 Haryana 122050, India  
 Operation frequency: N/A  
 Maximum output: N/A

**Radio remote control transmitter**

Hülsbeck & Fürst GmbH & Co. KG  
 Steeger Str. 17, 42551 Velbert,  
 Germany  
 Operation frequency: 433.92 MHz  
 Maximum output: 10 dBm

**Radio remote control receiver**

Delphi European, Middle Eastern &  
 African Regional Offices Customer  
 Technology  
 Center Avenue de Luxembourg,  
 L-4940 Bascharage, G.D. of  
 Luxembourg  
 Operation frequency: 119 - 128.6  
 Maximum output: 16dBµA/m @ 10m

**Electronic key transmitter**

Valeo  
 43 Rue Bayen, 75017 Paris, France  
 Operation frequency: 433.92 MHz  
 Maximum output: 10 dBm

**Immobiliser**

KOSTAL of America, Inc.  
 350 Stephenson Hwy, Troy MI 48083,  
 USA

Operation frequency: 125 kHz  
 Maximum output: 5 dBµA/m at 10m

**Radar unit**

ZF TRW Autocruise SAS  
 Secteur de la Pointe du Diable,  
 Avenue du technopôle, 29280  
 Plouzane, France  
 Operation frequency:  
 24.15 - 24.25 GHz  
 Maximum output: 20 dBm

**ICASA type approval numbers**

List of all Independent  
 Communications Authority of South  
 Africa (ICASA) type approval  
 numbers:  
 TA-2016/121, TA-2016/3261,  
 TA-2017/2387, TA-2017/2745,  
 TA-2013/430, TA-2017/1106,  
 TA-2016/929, TA-2017/3180



## REACH

Registration, Evaluation, Authorisation and Restriction of Chemicals (REACH) is a European Union regulation adopted to improve the protection of human health and the environment from the risks that can be posed by chemicals. Visit [www.opel.com](http://www.opel.com) for further information and for access to the Article 33 communication.

## Collision damage repair

### Paint thickness

Due to production techniques, the thickness of the paint can vary between 50 and 400 µm.

Therefore, different paint thickness is no indicator for a collision damage repair.

## Software update

The Infotainment system can download and install selected software updates over a wireless connection.

### Notice

The availability of these over-the-air vehicle software updates varies by vehicle and country. Find more information on our home page.

## Remote device management and remote software and firmware updates

As an integral part of the service related to the performance of subscribed connected service contracts, necessary device management and necessary software and firmware updates related to the software and firmware for the named connected service will be performed remotely, in particular by using over-the-air technology.

For this, a secure radio network connection between the vehicle and the device management server will be established when ignition is switched on and a mobile network is available. Depending on the equipment of the vehicle, connection configuration must be set to **Connected vehicle** to allow the establishment of the radio network connection.

Irrespective of a valid connected service subscription, remote product security or product safety related device management and software and firmware updates will be performed when the processing is necessary for the compliance with a legal obligation to which the manufacturer is subject (e.g. applicable product liability law, emergency call regulation) or when the processing is necessary in order to protect the vital interests of the respective vehicle users and passengers.

The establishment of a secure radio network connection and the related remote updates are not affected by privacy settings and will be performed in principal after an initiation by the vehicle user following a respective notification.

The system is able to notify receipt of an update as soon as it is connected to an exterior Wi-Fi network or a mobile network. Large updates are downloaded only via the Wi-Fi network.

The availability of an update is notified on the Info Display at the end of a trip with an option of immediate installation or postponement of installation.

The installation time is variable and can take several minutes with a maximum of about 30 minutes. A notification will give an estimate of the duration and a description of the update.

Updates can be checked manually via the Info Display. Follow the on-screen prompts in the respective menu.

Info Display ⇨ 88.

**Notice**

Steps for downloading and installing updates may vary by vehicle.

For safety reasons and because it requires sustained attention by the driver, the installation must be carried out with the ignition on without starting the engine. The installation cannot be carried out in the following cases:

- engine running
- emergency call in progress

- insufficient vehicle battery charge
- charging the vehicle's high voltage battery

**Notice**

During the installation process, the vehicle may not be operational.

If the update has failed, seek the assistance of a workshop.

**Registered trademarks**

**Apple Inc.**

Apple CarPlay™ is a trademark of Apple Inc.

App Store® and iTunes Store® are registered trademarks of Apple Inc.

iPhone®, iPod®, iPod touch®, iPod nano®, iPad® and Siri® are registered trademarks of Apple Inc.

**Bluetooth SIG, Inc.**

Bluetooth® is a registered trademark of Bluetooth SIG, Inc.

**DivX, LLC**

DivX® and DivX Certified® are registered trademarks of DivX, LLC.

**Google Inc.**

Android™ and Google Play™ Store are trademarks of Google Inc.

**Velcro Companies**

Velcro® is a registered trademark of Velcro Companies.

**Verband der Automobilindustrie e.V.**

AdBlue® is a registered trademark of the VDA.

## Vehicle data recording and privacy

### Event data recorders

Electronic control units are installed in your vehicle. Control units process data which they receive, e.g. by vehicle sensors or which they generate themselves or exchange amongst themselves. Some control units are necessary for the safe functioning of your vehicle, others assist you while you drive (driver assistance systems), while others provide comfort or infotainment functions.

The following contains general information about data processing in the vehicle. You will find additional information as to which specific data is uploaded, stored and passed on to third parties and for what purpose in your vehicle under the key word Data Protection closely linked to the references for the affected functional characteristics in the relevant Owner's Manual or in the general terms of sale. These are also available online.

### Operating data in the vehicle

Control units process data for operation of the vehicle.

This data includes:

- vehicle status information (e.g. speed, movement delay, lateral acceleration, wheel rotation rate, "seat belts fastened" display)
- ambient conditions (e.g. temperature, rain sensor, distance sensor)

As a rule such data is transient and is not stored for longer than an operational cycle, and only processed on board the vehicle itself. Often control units include data storage (including the vehicle key). This is used to allow information to be documented temporarily or permanently on vehicle condition, component stress, maintenance requirements and technical events and errors.

Depending on technical equipment levels, the data stored is as follows:

- system component operating states (e.g. fill level, tyre pressure, battery status)
- faults and defects in important system components (e.g. lights, brakes)
- system reactions in special driving situations (e.g. triggering of an airbag, actuation of the stability control systems)
- information on events damaging the vehicle
- for electric vehicles the amount of charge in the high-voltage battery, estimated range

In special cases (e.g. if the vehicle has detected a malfunction), it may be necessary to save data that would otherwise just be volatile.

When you use services (e.g. repairs, maintenance), the operating data saved can be read together with the vehicle identification number and used where necessary. Staff working for the service network (e.g. garages, manufacturers) or third parties (e.g.

breakdown services) can read the data from the vehicle. The same applies to warranty work and quality assurance measures.

Data is generally read via the OBD (On-Board Diagnostics) port prescribed by law in the vehicle. The operating data read documents the technical condition of the vehicle or individual components and assists with fault diagnosis, compliance with warranty obligations and quality improvement. This data, in particular information on component stress, technical events, operator errors and other faults, is transmitted to the manufacturer where appropriate, together with the vehicle identification number. The manufacturer is also subject to product liability. The manufacturer potentially also uses operating data from vehicles for product recalls. This data can also be used to check customer warranty and guarantee claims.

Fault memories in the vehicle can be reset by a service company when carrying out servicing or repairs or at your request.

### Comfort and infotainment functions

Comfort settings and custom settings can be stored in the vehicle and changed or reset at any time.

Depending on the equipment level in question, these include

- seat and steering wheel position settings
- chassis and air conditioning settings
- custom settings such as interior lighting

You can input your own data in the infotainment functions for your vehicle as part of the selected features.

Depending on the equipment level in question, these include

- multimedia data such as music, videos or photos for playback in an integrated multimedia system
- address book data for use with an integrated hands-free system or an integrated navigation system

- input destinations
- data on the use of online services

This data for comfort and infotainment functions can be stored locally in the vehicle or be kept on a device that you have connected to the vehicle (e.g. a smartphone, USB stick or MP3 player). Data that you have input yourself can be deleted at any time.

This data can only be transmitted out of the vehicle at your request, particularly when using online services in accordance with the settings selected by you.

### Smartphone integration, e.g. Android Auto or Apple CarPlay

If your vehicle is equipped accordingly, you can connect your smartphone or another mobile device to the vehicle so that you can control it via the controls integrated in the vehicle. The smartphone image and sound can be output via the multimedia system in this case. At the same time, specific information is transmitted to your smartphone. Depending on the type of integration,

this includes data such as position data, day / night mode and other general vehicle information. For more information, please see the operating instructions for the vehicle / infotainment system.

Integration allows selected smartphone apps to be used, such as navigation or music playback. No further integration is possible between smartphone and vehicle, in particular active access to vehicle data. The nature of further data processing is determined by the provider of the app used. Whether you can define settings, and if so which ones, is dependent on the app in question and your smartphone's operating system.

### **Online services**

If your vehicle has a radio network connection, this allows data to be exchanged between your vehicle and other systems. The radio network connection is made possible by means of a transmitter device in your vehicle or a mobile device provided by you (e.g. a smartphone). Online functions can be used via this radio network connection. These include online services and applications / apps provided to you by the manufacturer or other providers.

### **Proprietary services**

In the case of the manufacturer's online services, the relevant functions are described by the manufacturer in an appropriate location (e.g. Owner's Manual, the manufacturer's website) and the associated data protection information is provided. Personal data may be used to provide online services. Data exchange for this purpose takes place via a protected connection, e.g. using the manufacturer's IT systems provided for the purpose. Collection,

processing and use of personal data for the purposes of preparation of services take place solely on the basis of legal permission, e.g. in the case of a legally prescribed emergency communication system or a contractual agreement, or by virtue of consent.

You can activate or deactivate the services and functions (which are subject to charges to some extent) and, in some cases, the vehicle's entire radio network connection. This does not include statutory functions and services such as an emergency communication system.

### **Third party services**

If you make use of online services from other providers (third parties), these services are subject to the liability and data protection and usage conditions of the provider in question. The manufacturer frequently has no influence over the content exchanged in this regard.

Therefore, please note the nature, scope and purpose of the collection and use of personal data within the scope of third party services provided by the service provider in question.

### **Radio Frequency Identification (RFID)**

RFID technology is used in some vehicles for functions such as tyre pressure monitoring and immobiliser. It is also used in connection with conveniences such as radio remote controls for door locking / unlocking and starting. RFID technology in Vauxhall vehicles does not use or record personal information or link with any other Vauxhall system containing personal information.



# Index

## A

Accessories and vehicle modifications .....	201
Active emergency braking....	87, 157
Adaptive cruise control .....	149
AdBlue.....	85, 124
Adjustable air vents .....	113
Advanced lane keep assist... 83,	179
Advanced parking assist.....	163
Airbag and belt tensioners .....	80
Airbag deactivation .....	45, 81
Airbag label.....	40
Airbag system .....	40
Air conditioning regular operation .....	114
Air intake .....	114
Air vents.....	113
All-wheel drive .....	137
Antilock brake system .....	138
Antilock brake system (ABS) .....	83
Anti-theft alarm system .....	20
Anti-theft locking system .....	20
Appearance care.....	237
Armrest.....	36, 37
Ashtrays .....	74
Automatic anti-dazzle .....	24
Automatic crash notification.....	93
Automatic light control .....	97
Automatic locking .....	13

Automatic operation of electric parking brake off.....	83
Automatic transmission .....	131
Automatic transmission electrified.....	128
Autostop.....	86, 120
Auxiliary heater.....	111

## B

Battery discharge protection .....	105
Battery gauge.....	76
BlueInjection.....	124
Bonnet .....	206
Brake and clutch fluid.....	245
Brake and clutch system .....	82
Brake assist .....	140
Brake fluid .....	209
Brakes .....	138, 209
Breakdown.....	235
Bulb replacement .....	212

## C

Capacities .....	255
Catalytic converter .....	124
Central locking system .....	9
Centre console lighting .....	104
Centre console storage .....	55
Changing tyre and wheel size ...	224
Charge cord.....	185
Charge cord connected.....	85
Charging.....	187



Charging status.....	191
Charging system .....	81
Charging types.....	183
Child locks .....	14
Child restraint installation	
locations .....	50
Child restraints.....	47
Child restraint systems .....	47
Cigarette lighter .....	74
Clock.....	72
Collision damage repair.....	263
Control indicators.....	78
Control of the vehicle .....	116
Controls.....	68
Convex shape .....	22
Coolant and antifreeze.....	245
Cruise control .....	145
Cupholders .....	54
Curtain airbag system .....	45
Curve lighting.....	99
<b>D</b>	
Danger, Warnings and Cautions ...	4
Daytime running lights .....	99
Declaration of conformity.....	261
DEF.....	124
Deflation detection system.....	85
Diesel exhaust fluid.....	124
Diesel fuel system bleeding .....	211
Door open .....	87

Doors.....	15
Drive modes.....	136
Driver alert.....	181
Driver assistance systems.....	145
Driver Information Centre.....	87
Driving characteristics and	
towing tips .....	196
Driving hints.....	116

**E**

Electric adjustment .....	22
Electrical system.....	217
Electric parking brake.....	82, 138
Electric parking brake fault.....	82
Electric power consumption.....	183
Electric range.....	183
Electronic climate control system	106
Electronic driving programmes ..	134
Electronic key system.....	8
Electronic Stability Control and	
Traction Control system... ..	84, 142
Electronic Stability Control and	
Traction Control system off.....	84
Emergency call.....	93
End-of-life vehicle recovery .....	205
Engine compartment fuse box ...	217
Engine coolant .....	208
Engine coolant temperature .....	84
Engine coolant temperature	
gauge .....	77

Engine data .....	251
Engine exhaust .....	123
Engine identification.....	248
Engine oil .....	207, 245, 249
Engine oil level monitor.....	77
Engine oil pressure .....	85
Entry lighting .....	104
ERA GLONASS.....	94
Event data recorders.....	265
Exhaust filter.....	84, 123
Exit lighting .....	105
Exterior care .....	237
Exterior light .....	86
Exterior lighting.....	96
Exterior mirrors.....	22

**F**

Fault .....	135
First aid.....	61
First aid kit .....	61
Fixed air vents .....	114
Floor mats.....	239
Folding mirrors .....	23
Forward collision alert.....	155
Front airbag system .....	44
Front fog lights .....	86, 102, 213
Front pedestrian protection.....	159
Front seats.....	31
Fuel.....	192

Fuel consumption - CO <sub>2</sub> -	
Emissions .....	195
Fuel for diesel engines .....	192
Fuel for petrol engines .....	192
Fuel gauge .....	76
Fuses .....	217

**G**

Gauges.....	75
Gear selection .....	131
Gear shifting.....	83
General information.....	183, 196
Glass panel .....	28
Glovebox .....	54

**H**

Hazard warning flashers .....	101
Headlight flash .....	98
Headlight range adjustment .....	98
Headlights.....	96
Headlights when driving abroad ..	99
Head restraints .....	30
Heated mirrors .....	23
Heated rear window .....	27
Heated steering wheel .....	68
Heated windscreen.....	27
Heating .....	36, 37
High beam .....	86, 97
High beam assist.....	86, 97
Hill start assist .....	141
Horn .....	69

Hybrid system active.....	82
Hybrid system fault.....	82

**I**

Identification plate .....	247
Ignition switch positions .....	116
Immobiliser .....	22
Indicators.....	75
Inductive charging.....	73
Info Display.....	88
Instrument panel fuse box .....	218
Instrument panel illumination	
control .....	103
Instrument panel overview .....	66
Interior care .....	239
Interior lighting.....	103
Interior lights .....	103, 216
Interior mirrors.....	24
Interruption of power supply .....	135
Introduction .....	3

**J**

Jump starting .....	233
---------------------	-----

**K**

Keys .....	6
Keys, locks.....	6

**L**

Lane departure warning.....	83, 175
Lane keep assist.....	83, 177

Lashing eyes .....	59
LED headlights.....	86, 212
Lighting features.....	104
Light switch .....	96
Load compartment .....	15, 55
Load compartment cover .....	57
Loading information .....	62
Low beam.....	86
Low fuel .....	85

**M**

Malfunction indicator light .....	81
Manual anti-dazzle .....	24
Manual mode .....	133
Manual seat adjustment.....	32
Manual transmission .....	135
Matrix-LED headlights.....	99
Misted light covers .....	103

**N**

New vehicle running-in .....	116
Night vision.....	86, 169
Number plate light .....	216

**O**

Object detection systems.....	160
Odometer .....	75
Oil, engine.....	245, 249
Outside temperature .....	71
Overrun cut-off .....	120

- P**
- Panoramic view system..... 171
  - Parking ..... 122
  - Parking assist ..... 160
  - Parking brake ..... 138
  - Parking lights ..... 102
  - Particulate filter..... 123
  - Pedestrian safety alert..... 69
  - Pedestrian safety alert fault..... 87
  - Performance ..... 253
  - Performing work ..... 205
  - Power button..... 117
  - Power indicator gauge..... 76
  - Power outlets ..... 72
  - Power seat adjustment ..... 34
  - Power windows ..... 25
  - Preheating ..... 84
  - Programmable charging..... 190
  - Puncture..... 230
- Q**
- Quickheat..... 111
- R**
- Radio Frequency Identification (RFID)..... 268
  - Radio remote control ..... 7
  - Rain sensor..... 86
  - REACH..... 263
  - Reading lights ..... 104
  - Rear floor storage cover ..... 58
  - Rear fog light ..... 86, 102, 213
  - Rear seats..... 37
  - Rear view camera ..... 174
  - Rear window wiper and washer . . 71
  - Recommended fluids and lubricants ..... 245, 249
  - Reduced engine power..... 86
  - Refuelling ..... 193
  - Regenerative braking..... 141
  - Registered trademarks..... 264
  - Reversing lights ..... 103
  - Ride control systems..... 142
  - Roadside assistance..... 93
  - Roller blinds ..... 28
  - Roof..... 28
  - Roof load..... 62
  - Roof rack ..... 62
- S**
- Safety net ..... 59
  - Seat belt reminder ..... 80
  - Seat belts ..... 37
  - Seat heating..... 36
    - Seat heating, rear..... 37
  - Seat position ..... 31
  - Selective catalytic reduction..... 124
  - Selective ride control..... 143
  - Selector lever..... 131
  - Service ..... 114, 241
  - Service display ..... 77
  - Service information ..... 241
  - Service vehicle soon ..... 81
  - Side airbag system ..... 44
  - Side blind spot alert..... 87, 168
  - Sidelights..... 96
  - Side turn lights ..... 216
  - Software update..... 263
  - SOS..... 93
  - Spare wheel ..... 230
  - Speed limiter..... 147
  - Speedometer ..... 75
  - Sport mode ..... 144
  - Starting and operating..... 116
  - Starting the engine ..... 118
  - Steering..... 116
  - Steering wheel adjustment ..... 68
  - Steering wheel controls ..... 68
  - Stop engine..... 81
  - Stop-start system..... 120
  - Storage..... 54
  - Storage compartments..... 54
  - Sunvisor lights ..... 104
  - Sun visors ..... 28
  - Symbols ..... 4
  - System check..... 82
- T**
- Tachometer ..... 75
  - Tailgate..... 15
  - Tail lights ..... 213

Temperature preconditioning.....	111
Three-point seat belt .....	38
Tools .....	220
Tow bar.....	196
Towing.....	196, 235
Towing another vehicle .....	236
Towing equipment .....	197
Towing the vehicle .....	235
Traffic sign assistant.....	175
Trailer coupling.....	196
Trailer stability assist .....	200
Trailer towing .....	197
Transmission display .....	131
Tread depth .....	224
Turn lights .....	80, 101
Tyre chains .....	225
Tyre deflation detection system .	223
Tyre designations .....	222
Tyre pressure .....	222
Tyre pressures .....	256
Tyre repair kit .....	225
<b>U</b>	
Ultrasonic parking assist.....	160
Upholstery.....	239
USB port.....	72
Using this manual .....	3
<b>V</b>	
Vauxhall Connect.....	93
Vehicle battery .....	209

Vehicle checks.....	205
Vehicle data.....	249
Vehicle data recording and privacy.....	265
Vehicle dimensions .....	254
Vehicle identification number ...	247
Vehicle jack.....	220
Vehicle messages .....	91
Vehicle personalisation .....	92
Vehicle security.....	20
Vehicle specific data .....	3
Vehicle storage.....	203
Vehicle tools.....	220
Ventilating.....	36
Ventilation.....	111

**W**

Warning chimes .....	92
Warning lights.....	75
Warning triangle .....	61
Washer fluid .....	208
Wheel changing .....	228
Wheel covers .....	225
Wheels and tyres .....	221
Windows.....	25
Windscreen.....	25
Windscreen wiper and washer ...	69
Winter tyres .....	221
Wiper blade replacement .....	211

Copyright by Vauxhall Motors Ltd.

The information contained in this publication is effective as of the date indicated below. Vauxhall Motors Ltd. reserves the right to make changes to the technical specifications, features and design of the vehicles relative to the information contained in this publication, as well as changes to the publication itself.

Edition: August 2021, Vauxhall Motors Ltd.

Printed on chlorine-free bleached paper.

ID-VGDAORIE2108-en

