

**VAUXHALL** Tigra

Owner's Manual  
Model Year 2009.0  
Edition: July 2008  
TS 1622-A-09

Operation, Safety, Maintenance

## Data specific to your vehicle

Please enter your vehicle's data here to keep it easily accessible. You can find it in the "Service and Maintenance" and "Technical Data" sections and also on the identification plate.

### Fuel

Designation

### Engine oil

Grade

Viscosity

### Tyre pressure

	Tyre size	front	rear
Summer tyres	<input type="text"/>	<input type="text"/>	<input type="text"/>
Winter tyres	<input type="text"/>	<input type="text"/>	<input type="text"/>

### Weights

	Gross vehicle weight rating	<input type="text"/>
-	EC kerb weight	<input type="text"/>
=	Loading	<input type="text"/>

## Introduction

Your vehicle is an intelligent combination of forward-looking technology, impressive safety, environmental friendliness and economy.

The retractable steel roof also gives you the opportunity to enjoy your Tigra as a coupe or a convertible.

It now lies with you to drive your vehicle safely and ensure that it performs perfectly. This Owner's Manual provides you with all the necessary information to that end.

Make sure your passengers are aware of the possible risk of accident and injury which may result from improper use of the vehicle.

You must always comply with the specific laws of the country that you are travelling in. These laws may differ from the information in this Owner's Manual.

When this Manual refers to a workshop visit, we recommend you use a Vauxhall Authorised Repairer.

All Vauxhall Authorised Repairers provide first-class service at reasonable prices. Experienced mechanics trained by Vauxhall work according to specific Vauxhall instructions.

The Owner's Manual, Infotainment system instructions and the vehicle Service and Warranty Booklet should always be kept ready to hand in the vehicle glove compartment.

## Make use of the Owner's Manual

- The "In Brief" section will give you an initial overview,
- The table of contents at the beginning of the Owner's Manual and within the individual chapters will show you where everything is.
- Its index will help you find what you want.
- Yellow arrows in the illustrations serve as points of reference or indicate some action to be performed.
- Black arrows in the illustrations indicate a reaction or a second action to be performed.
- This Owner's Manual depicts right-hand drive vehicles. Operation is similar for left-hand drive vehicles.
- The Owner's Manual uses the internal engine codes. The corresponding sales designations are found in the chapter "Technical data".
- Directional data, e.g. left or right, or front or back, in the descriptions always relate to the direction of travel.

## Symbols

► Continue reading on next page.

\* The asterisk signifies equipment not fitted to all vehicles (model variants, engine options, models specific to one country, optional equipment, Vauxhall genuine parts and accessories).

Page references are indicated with ⇨ .  
⇨ means "see page".

## ⚠ Danger, ⚠ Warning, Caution

### ⚠ Danger

Text marked ⚠ **Danger** provides information on risk of fatal injury. Failure to comply with the instructions could endanger life.

### ⚠ Warning

Text marked ⚠ **Warning** provides information on risk of accident or injury. Failure to comply with the instructions could lead to injury.

### Caution

Text marked **Caution** provides information on possible damage to the vehicle. Failure to comply with the instructions could lead to vehicle damage.

Thank you for choosing a Vauxhall. We wish you many hours of pleasurable driving.

## Your Vauxhall Team



# Contents

## **Commitment to customer satisfaction:**

**Our aim:** to keep you happy with your vehicle. All Vauxhall Authorised Repairers offer first-class service at competitive prices. Experienced, factory-trained technicians work according to factory instructions. Your Authorised Repairer can supply you with GENUINE VAUXHALL-APPROVED PARTS, which have undergone stringent quality and precision checks, and of course useful and attractive VAUXHALL-APPROVED ACCESSORIES.

**Our name is your guarantee!**







**For details of the Vauxhall Authorised Repairer Network, please ring this number; 0845 090 2044**

In Brief .....	2
Keys, Doors, Windows, Retractable Steel Roof .....	20
Seats, Interior .....	44
Instruments, Controls .....	66
Lighting .....	86
Infotainment System .....	90
Climate Control .....	92
Driving and Operation .....	100
Self-help, Vehicle Care.....	126
Service and Maintenance .....	152
Technical Data .....	168
Index .....	180

## In Brief



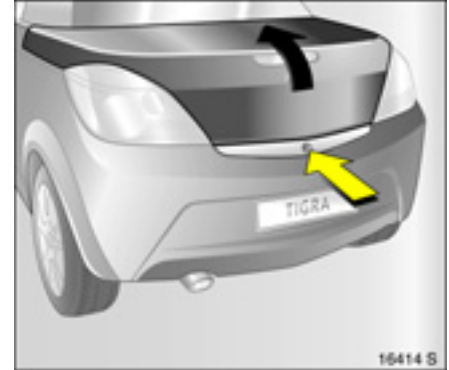

**To unlock the driver's door:  
Press button **

Door locks ,  
Key ,  
Electronic immobiliser ,  
Remote control ,  
Central locking ,  
Vauxhall alarm system .



**To unlock and open luggage  
compartment: Press button  on  
remote control twice, press  
button beneath the boot lid**

To unlock with button  on  
handle: With vehicle unlocked, ignition on  
and handbrake applied, briefly pull  
button .

Luggage compartment ,  
Remote control .

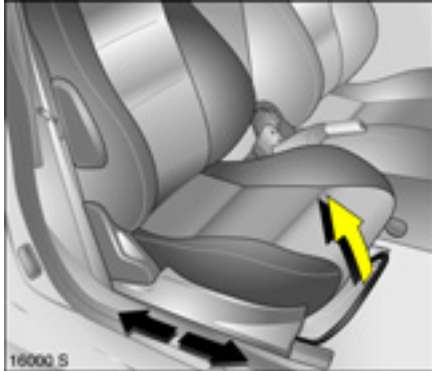

**To adjust seat leg room:  
Pull handle, slide seat,  
release handle**

Seats ⇨ 44,  
Seat position ⇨ 45.

**⚠ Warning**

Important: Do not sit nearer than 10 inches (25 cm) from the steering wheel, to permit safe airbag deployment.

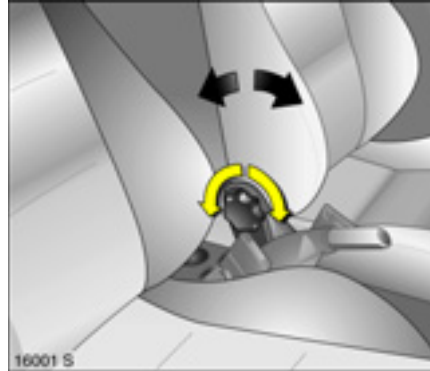

**To adjust seat backrests:  
Turn handwheel**

Do not lean on seat backrest whilst adjusting it.

Seats ⇨ 44,  
Seat position ⇨ 45.

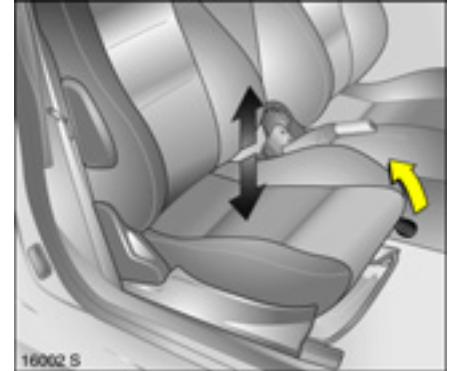

**Seat cushion height: Pull lever**

Lift lever and relieve some weight from seat to raise it or press down on seat with body weight to lower it.

Seats ⇨ 44,  
Seat position ⇨ 45.

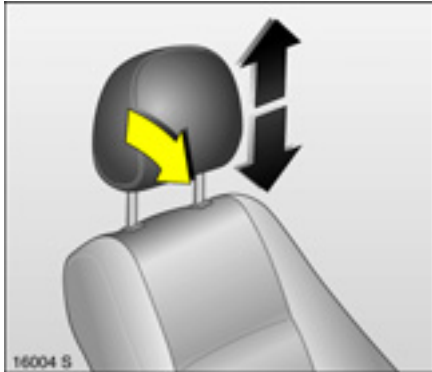

**Head restraint height: To release, tilt head restraint forward, hold and adjust height, engage**

Head restraints ⇨ 46,  
Head restraint position ⇨ 47,  
Head restraint removal ⇨ 47.



**Pull out the seat belt and click into belt buckle**

The seat belt must not be twisted and must lie snugly against the body. The backrest must not be tilted back too far (maximum approx. 25°).

To release belt, press red button on belt buckle.

Three-point seat belts ⇨ 49,  
Airbag system ⇨ 54,  
Seat position ⇨ 45.



**Adjust exterior mirrors**

Select corresponding exterior mirror and adjust with the four-way switch.

Mirrors ⇨ 31,  
Aspherical exterior mirrors ⇨ 31,  
Heated exterior mirrors ⇨ 11, ⇨ 32.



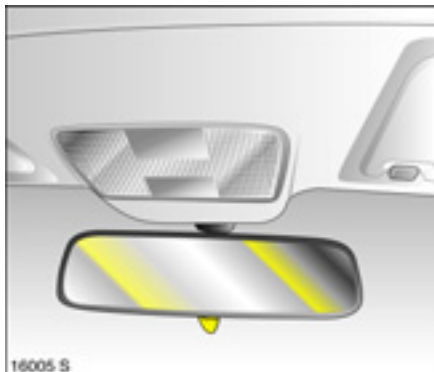

### To adjust interior mirror by swivelling

Swivel lever on underside of mirror housing to reduce dazzle.

Interior mirror ⇨ 32.

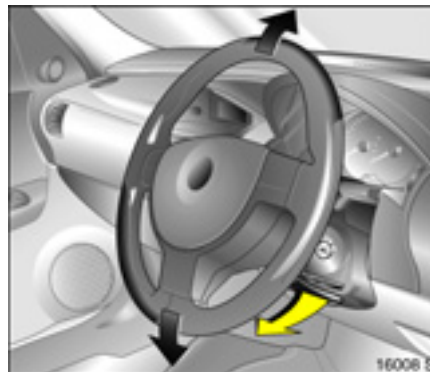

### Steering wheel adjustment \*: Swivel lever down, adjust height, swivel lever up, engage



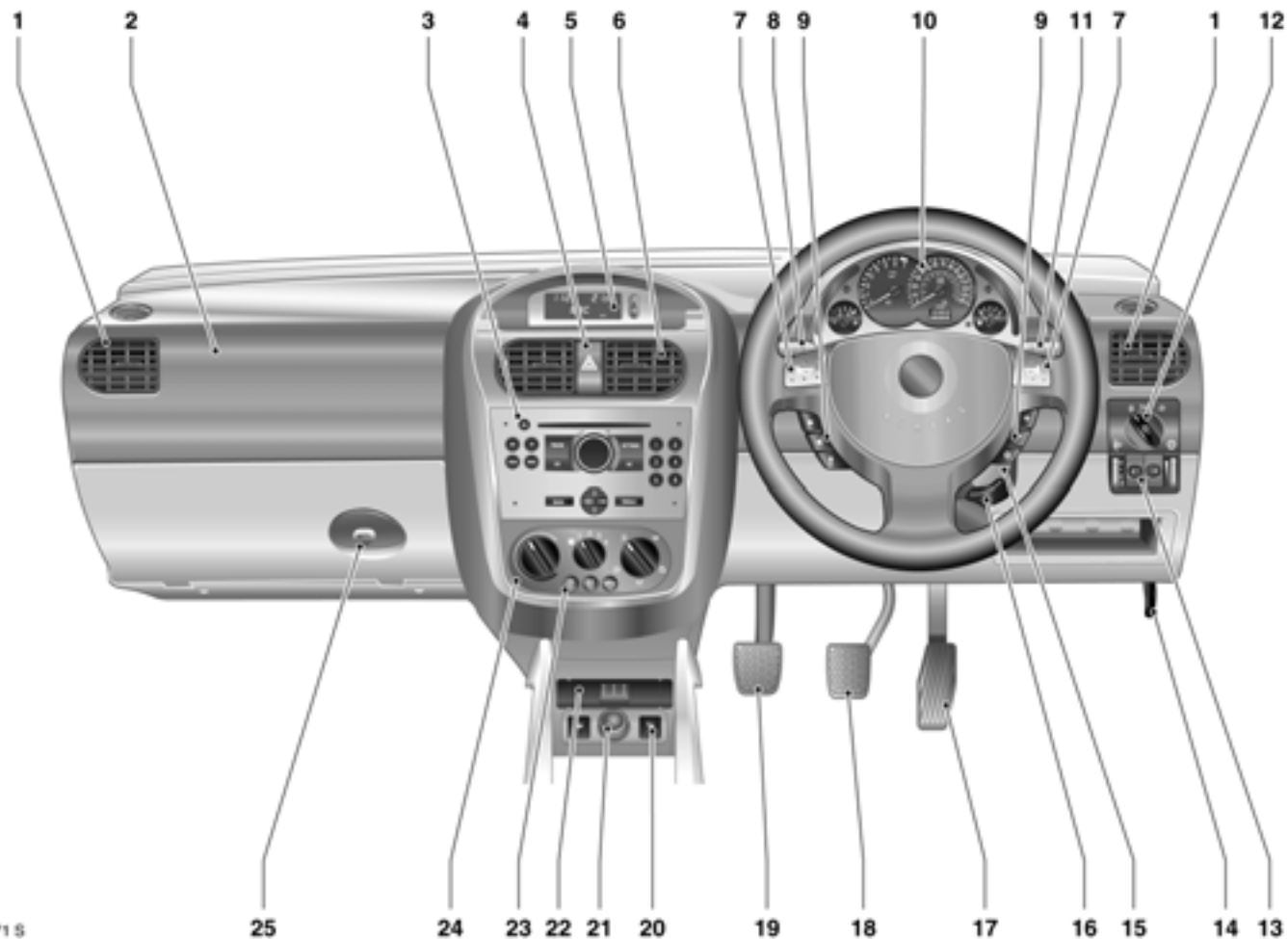

Adjust steering wheel only when vehicle is stationary and steering column lock is released.







Airbag system ⇨ 54,  
Steering column lock ⇨ 13.









- 
- |  |   |  |
|--|---|--|
| <p>1 Side air vents ..... ⇨ 92</p> <p>2 Front passenger airbag ..... ⇨ 54</p> <p>3 Infotainment system * ..... ⇨ 74, ⇨ 91</p> <p>4 Hazard warning lamps ..... ⇨ 10, ⇨ 88<br/>LED for Vauxhall alarm<br/>system * ..... ⇨ 30</p> <p>5 Information display<br/>for time, date,<br/>outside temperature,<br/>Infotainment system * ..... ⇨ 74<br/>Trip computer * ..... ⇨ 81</p> <p>6 Centre air vents ..... ⇨ 92</p> <p>7 Horn ..... ⇨ 10<br/>Driver's airbag ..... ⇨ 54</p> | <p>8 Turn signal lamps ..... ⇨ 9, ⇨ 87<br/>Headlamp flash ..... ⇨ 9, ⇨ 87<br/>Dipped beam,<br/>Main beam ..... ⇨ 9, ⇨ 87<br/>Door-to-door lighting * ..... ⇨ 88<br/>Cruise control * ..... ⇨ 116</p> <p>9 Remote control on steering<br/>wheel * ..... ⇨ 90</p> <p>10 Instruments ..... ⇨ 66, ⇨ 72</p> <p>11 Windscreen wipers ..... ⇨ 10, ⇨ 85<br/>Windscreen washer<br/>system ..... ⇨ 11, ⇨ 85</p> <p>12 Parking lamps,<br/>dipped beam ..... ⇨ 9, ⇨ 86</p> <p>13 Headlamp range adjustment ..... ⇨ 88<br/>Fog tail lamp ..... ⇨ 87<br/>Front fog lamps * ..... ⇨ 87<br/>Instrument illumination ..... ⇨ 89</p> <p>14 Bonnet release lever ..... ⇨ 126</p> | <p>15 Ignition switch<br/>with steering column lock ..... ⇨ 13</p> <p>16 Steering wheel adjustment * ..... ⇨ 5</p> <p>17 Accelerator pedal ..... ⇨ 106, ⇨ 108</p> <p>18 Brake pedal ..... ⇨ 70, ⇨ 106, ⇨ 119</p> <p>19 Clutch pedal * ..... ⇨ 106</p> <p>20 Heated seats * ..... ⇨ 46</p> <p>21 Accessory socket or<br/>cigarette lighter ..... ⇨ 63</p> <p>22 Ashtray * ..... ⇨ 64</p> <p>23 Air conditioning system * ..... ⇨ 96<br/>Heated rear window ..... ⇨ 11, ⇨ 34<br/>Air recirculation system * ..... ⇨ 97</p> <p>24 Climate control ..... ⇨ 92</p> <p>25 Glove compartment ..... ⇨ 65</p> |
|--|---|--|

Control indicators

-  **Seat belt \***,  
◇ 66, ◇ 49.
-  **Front fog lamps \***,  
◇ 66, ◇ 87.
-  **Engine electronics, Immobiliser \*, Easytronic \*, Fault,**  
◇ 21, ◇ 67, ◇ 104, ◇ 112.
-  **Exhaust emission \*,**  
◇ 67, ◇ 112.
-  **Airbag systems, Belt tensioners,**  
◇ 50, ◇ 58.

-  **Engine oil pressure,**  
◇ 68.
-  **Turn signal lamps,**  
◇ 9, ◇ 69, ◇ 87.
-  **Main beam,**  
◇ 9, ◇ 69, ◇ 87.
-  **Preheating for diesel engines \*,**  
◇ 69.
-  **Easytronic \*, Start engine \*,**  
◇ 69, ◇ 101.
-  **Easytronic \*, Winter programme,**  
◇ 103.
-  **Fog tail lamp,**  
◇ 69, ◇ 87.

-  **Alternator,**  
◇ 69.
-  **Brake system, clutch system,**  
◇ 70, ◇ 164.
-  **Anti-lock Braking System (ABS) \*,**  
◇ 120.
-  **Engine oil level \*,**  
◇ 70, ◇ 160.
- EPS** **Electric Power-assisted Steering (EPS) \*,**  
◇ 70.
-  **Electronic Stability Programme (ESP<sup>®</sup>Plus) \*,**  
◇ 71, ◇ 114.
-  **Fuel level,**  
◇ 71, ◇ 111.
-  **Seat occupancy recognition \*,**  
◇ 71, ◇ 59.



### Exterior lights

Turn

- O** = Off
- ☛☛** = Parking lamps
- ☛D** = Dipped beam or main beam

Press

- ☛D** = Front fog lamps \*
- ☛☛** = Fog tail lamp
- ☛☛** = Courtesy lamp

Lighting ⇨ 86,  
Headlamp warning buzzer ⇨ 14, ⇨ 84.

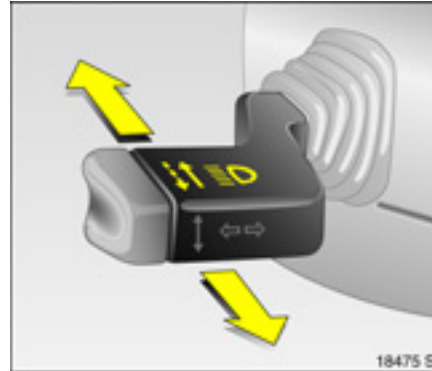

### Headlamp flash, main beam and dipped beam

- Headlamp flash = Pull stalk towards steering wheel
- Main beam = Push stalk forwards
- Dipped beam = Push stalk forwards again

Main beam, headlamp flash ⇨ 87.

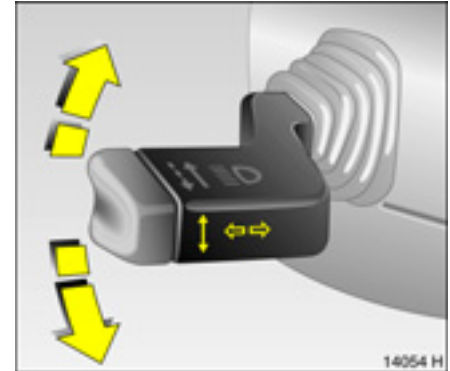

### Switch on turn signal lamps

- Right = Stalk up
  - Left = Stalk down
- Turn signal lamps ⇨ 87.

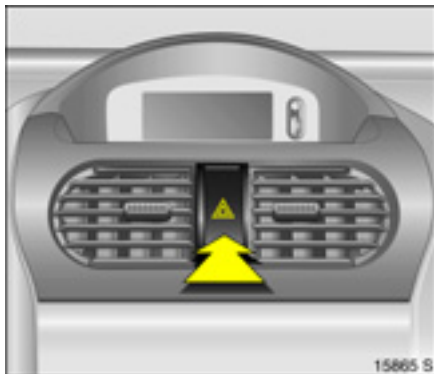

### Hazard warning lamps

Operated with the  button.

Hazard warning lamps ⇨ 88.

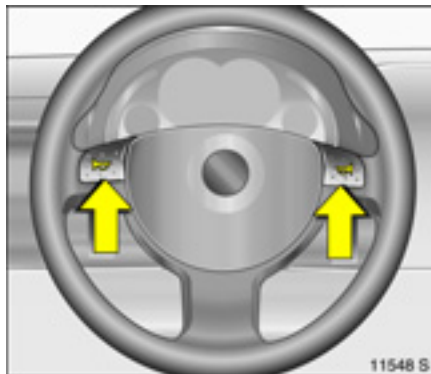

### Horn : press right or left

Airbag system ⇨ 54,

Remote control on steering wheel \* ⇨ 90.

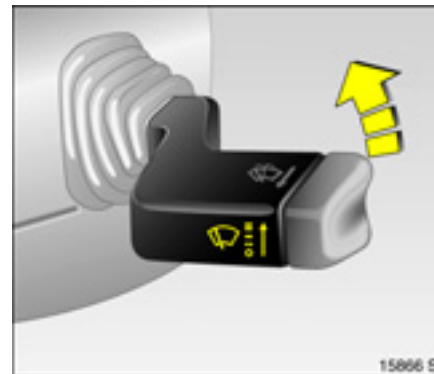

### Windscreen wipers

— = Fast

- - = Slow

- - \* = Adjustable timed interval wipe

○ = Off

Windscreen wipers ⇨ 85,

Adjustable wiper interval \* ⇨ 85,

Change windscreen wipers ⇨ 165.

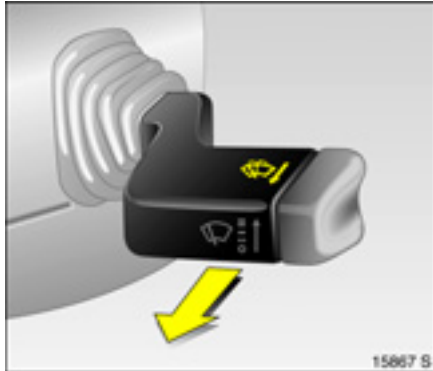

### Operating windscreen washer system: Pull stalk toward steering wheel

The wipers will swipe for a few strokes.

Windscreen washer system ↗ 85,  
further information ↗ 165.

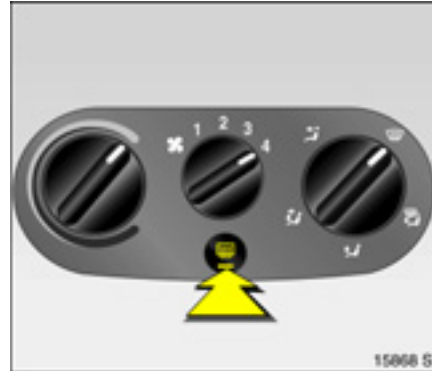



### Heated rear window, heated exterior mirrors

Operated with the  button.

Climate control system \* ↗ 92,  
Heated rear window ↗ 34.



### To clear fogged or icy windows

Rotary knob for temperature and air flow clockwise, air distribution to ,  
Air conditioning system \*: also press  
button .

Climate control system \* ↗ 92.

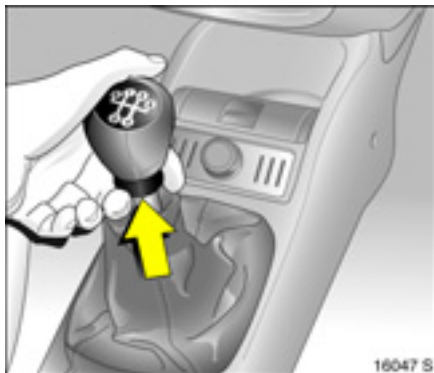

### Manual transmission

Reverse: With the vehicle stationary, depress the clutch pedal, wait 3 seconds, then raise ring under gearshift lever and engage gear.

If the gear does not engage, set the lever in neutral, release the clutch pedal and depress again; then repeat gear selection.

Manual transmission ⇨ 105.

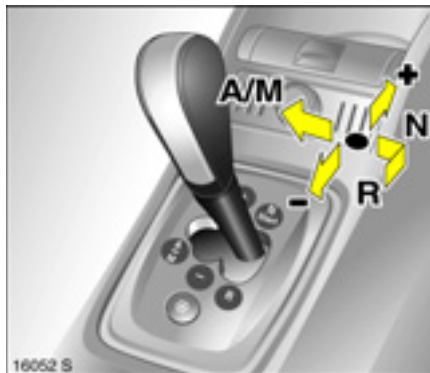

### Easytronic \*

- N** = Neutral/idle/start position
- = Driving position
- +
- = Lower gear
- A/M** = Switch between Automatic and Manual mode.
- R** = Reverse gear  
(with selector lever lock)

To move the selector lever from **N** to **R** press the button on the lever.

Only start in **N** with footbrake depressed.

Easytronic \* ⇨ 100.

### Before starting off, check

- Tyre pressure and tyre condition ⇨ 121, ⇨ 176.
- Engine oil level and fluid levels ⇨ 159 to ⇨ 165.
- All windows, mirrors, exterior lighting and number plates are free from dirt, snow and ice and operational.
- Seats, seat belts and mirrors are correctly adjusted. ⇨ 44, ⇨ 49, ⇨ 31
- Check brake function at low speed, particularly if the brakes are wet.



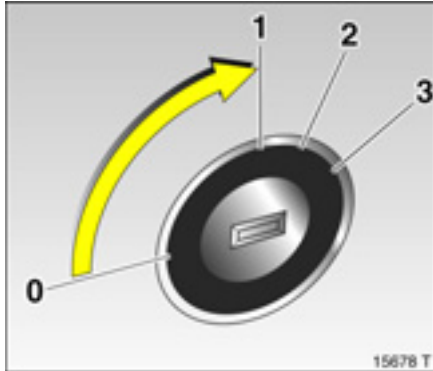

### Steering column lock and ignition

Turn key to position 1. Move the steering wheel slightly to release the steering column lock.

- 0 = Ignition off
- 1 = Steering free, ignition off
- 2 = Ignition on, for diesel engine: preheating
- 3 = Starting

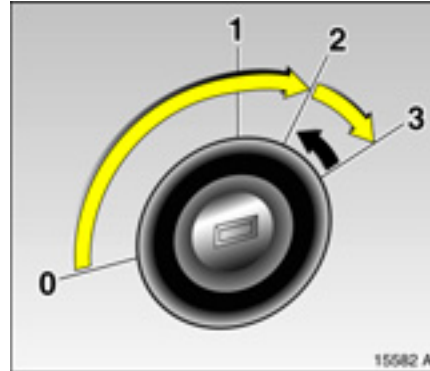

### Starting the engine

Depress the clutch and brake pedals, Easytronic  $\star$  in N, do not press accelerator, for diesel engine: turn key to 2 until control indicator  $\infty$  goes out, turn key to 3; release key when engine is running.

Before restarting or switching off the engine, turn key back to 0.

To switch on the ignition, only turn the key to 2.

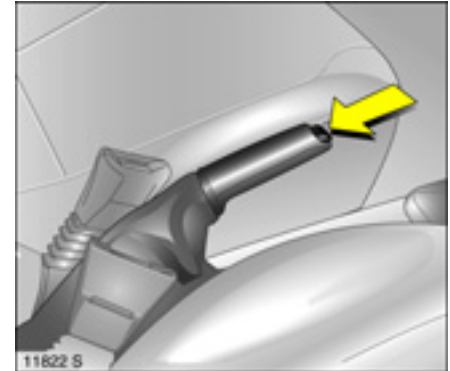

### Releasing the handbrake: Raise lever slightly, Press release button, Lower lever fully

Handbrake  $\rightarrow$  121.

## Parking the vehicle

- Always apply handbrake without pressing release button. Apply as firmly as possible on a downhill slope or uphill slope. Operate footbrake at same time to reduce operating force.
- Switch off engine and ignition. To do this, turn ignition key to 0 and remove. Turn steering wheel until steering column lock perceptibly engages (anti-theft protection).

On vehicles with Easytronic ✱, control indicator (D) flashes for a few seconds after the ignition is switched off if the handbrake has not been applied.

- If the vehicle is on a level surface or uphill slope, engage first gear before switching off the ignition. On an uphill slope, turn the front wheels away from the kerb.

If the vehicle is on a downhill slope, engage reverse gear before switching off the ignition. Turn the front wheels towards the kerb.

- Lock vehicle and arm Vauxhall alarm system ✱ with button = on the remote control.

To activate the anti-theft locking system ✱, press button = twice.

## Advice when parking

- Do not park the vehicle on flammable ground as combustion could occur due to the high exhaust temperatures.
- Close windows and retractable steel roof.
- The engine cooling fans may run after the engine has been switched off, ⇨ 159.
- After running at high engine speeds or with high engine loads, operate the engine briefly at a low load or run in neutral for approx. 30 seconds before switching off in order to protect the turbocharger ✱.

Remote control ✱ ⇨ 22,  
Central locking system ⇨ 23,  
Vauxhall alarm system ✱ ⇨ 29,  
Laying the vehicle up for a long period  
⇨ 166.

## Interesting functions

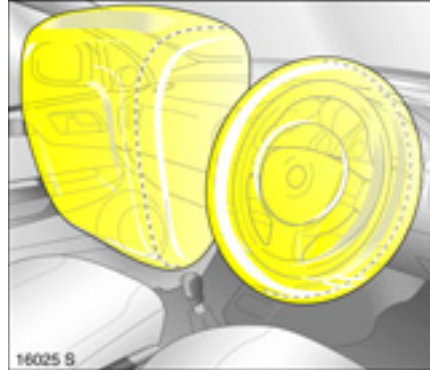

### **Airbag system**

The airbag system consists of several separate systems.

#### **Front airbag system**

The front airbag system will be triggered in the event of a serious accident involving a frontal impact and forms safety cushions for the driver and front passenger. The forward movement of the driver and front passenger is checked and the risk of injuries to the upper body and head thereby substantially reduced.

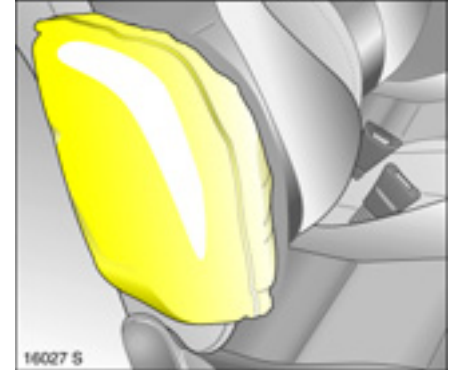

### **Side airbag system**

The side airbag is triggered in the event of a side-on collision to form a safety cushion for the driver or front passenger in the respective door area. This substantially reduces the risk of injury to the upper body and pelvis.

Airbag system ↗ 54.



### Operating menus in the information display \*

Menu options are selected using menus and using the buttons/four-way button or the multifunction knob of the Infotainment system \* or the buttons \* on the steering wheel. The respective menu options are shown on the display.

Selection using four-way button: press four-way button at top, bottom, left or right.



Selection using multifunction knob \*: rotate and press multifunction knob.

To exit a menu, turn the multifunction knob left or right to **Return** or **Main** and select.



To select with steering wheel buttons \*: Select menu options via the menus and the buttons.

Information display ↻ 74.

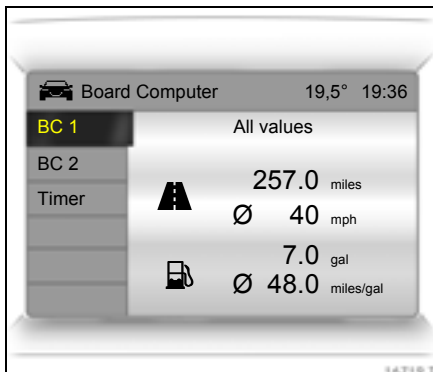

### Trip computer \*

Functions:

- Range
- Instantaneous consumption
- Distance travelled
- Average speed
- Effective consumption
- Average consumption
- Stop watch

Trip computer ⇨ 81.



### Opening retractable steel roof

Only with vehicle stationary.

- Apply handbrake
- Engage the luggage compartment partition in the rear position.
- Place no objects in front of the rear window or in front of the luggage compartment partition.
- Close the boot lid.

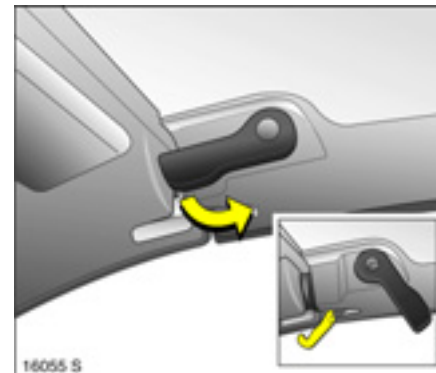

- Release the locking levers on upper right and left of the window frames, pulling both levers all the way down. The retaining hook must unhook.

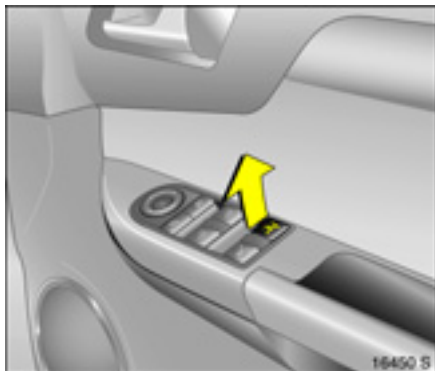

- Switch on ignition.
- Pull  until the roof is completely open and the boot lid is closed.

An acoustic signal sounds at the beginning and end of the procedure.

If the handbrake is not applied, the roof lock is not released or the luggage compartment partition is not folded back when button  is actuated, a warning buzzer sounds and the roof does not open.

Retractable steel roof ⇨ 34.

### Closing retractable steel roof

Only with vehicle stationary and boot lid closed.

The luggage compartment partition must be engaged in its rear position. Do not place any objects in front of the luggage compartment partition.

- Apply handbrake
- Switch on ignition.

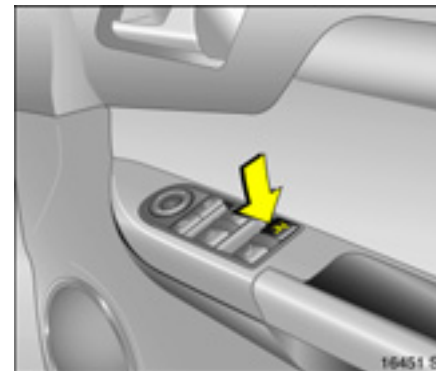

- Press  until the roof and boot lid are completely closed.

An acoustic signal sounds at the beginning and end of the procedure.

If button  is actuated when the handbrake is not applied, a warning buzzer sounds and the roof remains open.

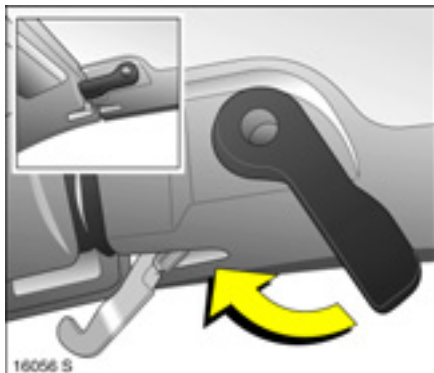

- Move the locking levers on right and left of the window frames all the way up. Each retaining hook must engage and the roof must lock securely.

Retractable steel roof ⇨ 34.



### Ultrasonic parking sensors \*

When reverse gear is selected, the parking distance sensors switch on automatically.

An acoustic warning sounds when the vehicle approaches an obstacle behind it.

- ▶ Ultrasonic parking sensors \* ⇨ 118.

## Keys, Doors, Windows, Retractable Steel Roof

Replacement keys .....	20
Lock cylinders .....	20
Key with retractable key blade * .....	20
Car Pass.....	20
Electronic immobiliser.....	21
Remote control *.....	22
Central locking system .....	23
Operating central locking system with key in driver's door lock .....	25
Luggage compartment.....	26
Vauxhall alarm system *.....	29
Exterior mirrors.....	31
Interior mirror .....	32
Electric windows.....	32
Retractable steel roof.....	34
Wind deflector *.....	43

### Replacement keys

The key number is specified in the Car Pass \*.

The key is part of the electronic immobiliser.

Locks ⇨ 151.

### Lock cylinders

Designed to free-wheel if they are forcefully rotated without the correct key or if the correct key is not fully inserted.

To reset, turn cylinder with the correct key until its slot is vertical, remove key and then re-insert it. If the cylinder still free-wheels, turn the key through 180° and repeat operation.



### Key with retractable key blade \*

Press button to extend. Press button to retract; key section engages audibly.

### Car Pass

The Car Pass contains safety-related vehicle data and should therefore be kept in a safe place.

When the vehicle is taken to a workshop, the Car Pass data is needed in order to perform certain operations.



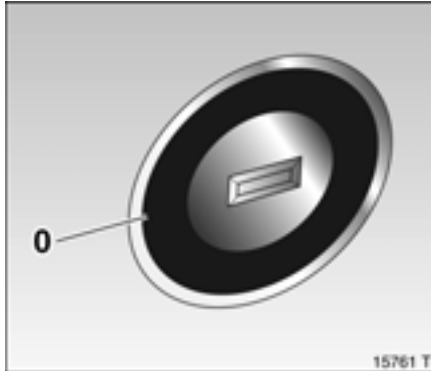

### Electronic immobiliser

The system checks whether the vehicle is allowed to start with the key used. Once the transponder in the key is recognised, the vehicle can be started.

The electronic immobiliser activates automatically when the key is removed from the ignition switch.



### Control indicator for immobiliser

Control indicator illuminates briefly when the ignition is switched on.

If the control indicator flashes when the ignition is on, there is a fault in the system; the engine cannot be started. Switch off the ignition and then repeat the start attempt.

If the control indicator continues to flash, try to start the engine using the second key and contact a workshop for assistance.

If control indicator illuminates after the engine has started, there is a fault in the engine electronics or transmission electronics \* 67, 104, 112 or there is water in the diesel fuel filter \* 162.

### Note

The immobiliser does not lock the doors. You should always lock the vehicle after leaving it and switch on the Vauxhall alarm system \* 23.



### Remote control ✱

Depending on equipment level, the vehicle comes equipped with one of the remote controls depicted on this page.

The remote control is integrated in the key.

Used to operate:

- central locking system,
- mechanical anti-theft locking system ✱,
- Vauxhall alarm system ✱.

The windows can also be closed using the remote control.



The remote control has a range of approx. 5 metres. This range can be affected by outside influences. Aim the remote control at the vehicle to operate. The hazard warning lamps flash to confirm remote control operation.

Handle the remote control with care, protect it from moisture and high temperatures and avoid unnecessary operation.

### Fault

If the central locking system cannot be operated with the remote control, it may be due to the following:

- Range exceeded.
- Battery voltage in remote control too low, change battery.
- Frequent successive activations of the remote control outside the range of the vehicle (this means that the remote control is no longer recognized). Synchronise remote control.
- If the central locking system is overloaded as a result of repeated operation at short intervals. The power supply is cut off for a brief period.
- Interference from higher-power radio waves from other sources.

Opening the vehicle ⇨ 25.

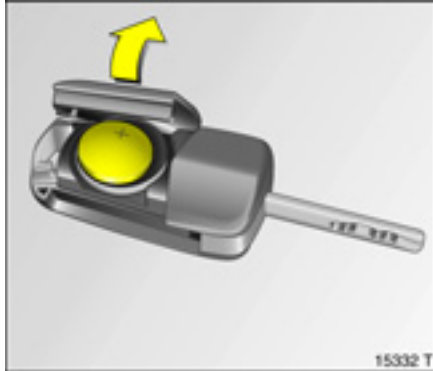

Key with fixed key bit,  
see Fig. 15331 T on previous page.

Have the workshop change the battery.

**Remote control synchronisation**

After changing the battery, unlock the door using the key. Insert the key in the ignition lock to synchronise the remote control.

**Remote control battery replacement**

Replace the battery as soon as the range of the remote control begins to shrink.

Batteries do not belong in household waste. They must be disposed of at an appropriate recycling collection point.

Key with retractable key blade,  
see Fig. 15330 T on previous page.

Extend the key ↗ 20. Open the remote control. Replace the battery (battery type CR 20 32), noting installation position. Close the remote control and synchronise.



**Central locking system**

Used to unlock and lock doors, luggage compartment cover and tank flap.

**To unlock**

Unlock driver's door only

Press button  on remote control once.

Unlock entire vehicle

Press button  on remote control twice.

The vehicle can also be unlocked by pulling the door handles if the anti-theft locking system is disabled.



**To lock**

Close doors, luggage compartment and tank flap.

Press button  on remote control.

– or from the inside –

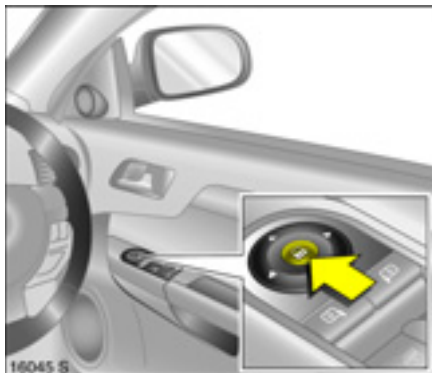

Press button  in the door.

The vehicle can be locked even if the driver's door is open. Risk of being locked out.

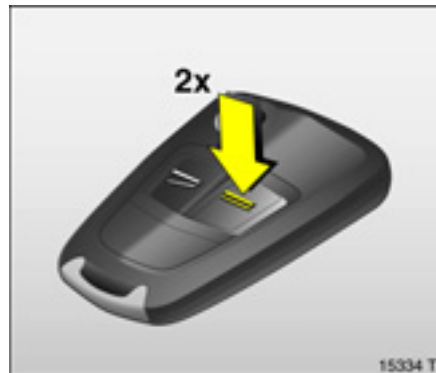

**Mechanical anti-theft locking system\***

**⚠ Warning**

Do not use the system if there are people in the vehicle! The doors cannot be unlocked from the inside.

All doors must be closed.



If the ignition was on, the driver's door must be opened and closed once so that the vehicle can be secured.

All doors are secured against opening.

Within 10 seconds of locking, press the  button on the remote control again.

Unlocking the vehicle switches off the mechanical anti-theft locking system.

**Note**

- A short time after unlocking using the remote control the doors lock again automatically if no door is opened.
- To lock the doors from inside (e.g. to prevent unwanted entry from outside), press central locking switch  in the door trim.
- The vehicle can be locked without the need for the key. With the driver's door open, press central locking switch  in the door trim and then close the driver's door. Note that unintentional actuation could cause one to be locked out.
- Locked doors and luggage compartment unlock automatically in the event of an accident of a certain severity (to permit outside assistance). Prerequisite: Ignition must not be switched off.

**Fault**

If the central locking cannot be operated, this can be for one of the following reasons:

- If the central locking system is overloaded as a result of repeated operation at short intervals. The power supply is cut off for a brief period.
- Faulty fuse in fuse box ⇨ 140.

To eliminate the cause of the fault, contact a workshop.

Use the key to open and close the driver's door.

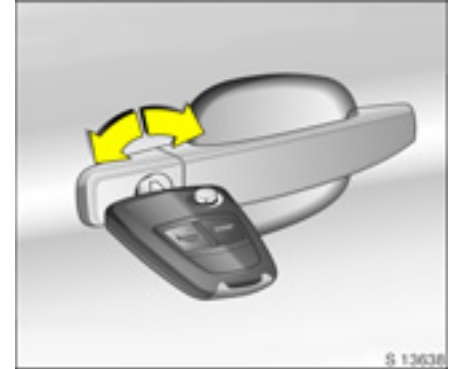

**Operating central locking system with key in driver's door lock**

**To unlock**

Turn key forward in lock as far as it will go. Turn back to vertical position and remove.

If the anti-theft locking system \* is engaged, only the driver's door will unlock. To unlock the entire vehicle: switch on the ignition, press central locking switch  and pull the driver's door handle.

**To lock**

With doors closed, turn key towards rear of vehicle as far as it will go. Turn back to vertical position and remove.

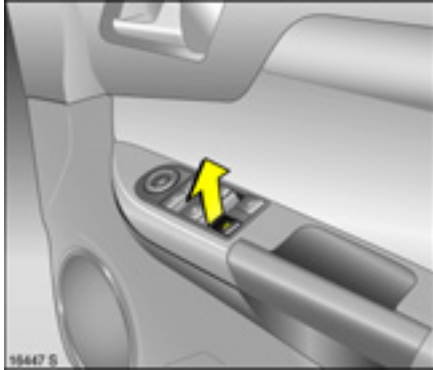

### Luggage compartment

To open with the button in the driver's door handle

1. Unlock entire vehicle ⇨ 23.
2. Apply handbrake.
3. Switch on ignition.
4. Briefly press button . The opening process begins after a slight delay.

Pressing the button again stops the opening process.

If the handbrake is not engaged when the button is pressed, a warning buzzer sounds and the luggage compartment remains closed.

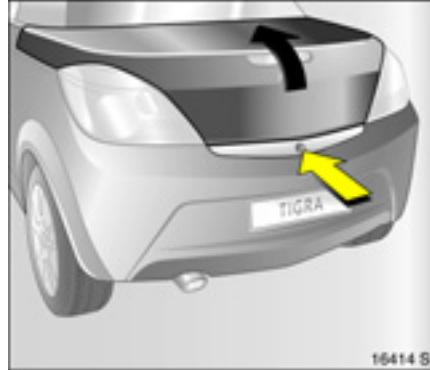

To open with the button beneath the boot lid

1. Unlock entire vehicle ⇨ 23.
2. Briefly press the button beneath the boot lid. The opening process begins after a slight delay.

Pressing the button again stops the opening process.

If the ignition is on but the handbrake is not applied when the button is pressed, a warning buzzer sounds and the luggage compartment remains closed.

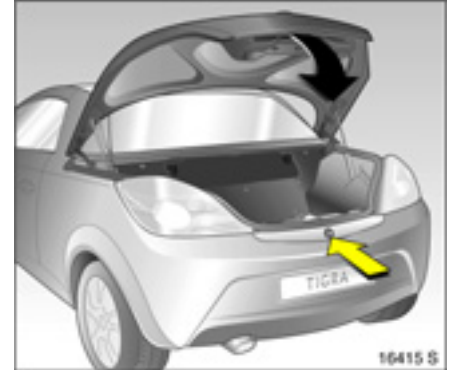

To close:

Press the button below the boot lid until the lid is completely closed.

If the ignition is on but the handbrake is not applied when the button is pressed, a warning buzzer sounds and the luggage compartment closes.

A tone sounds when the boot lid is completely closed. Locking of the lid is indicated by a single flash of the hazard warning lamps.

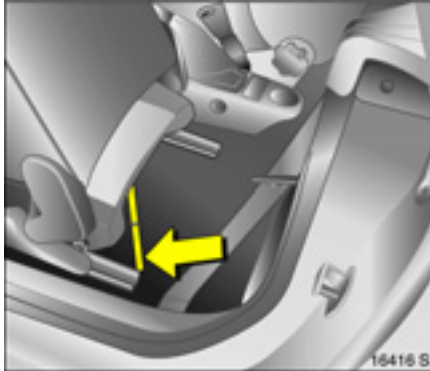

### Fault

The boot lid can only be operated if the roof has been fully and correctly closed or opened beforehand.

In the event of automatic drive malfunction or loss of battery power, the boot lid is manually opened as follows:

1. Open the door.
2. Fold down the seat backrest. The tool is fastened underneath the seat.

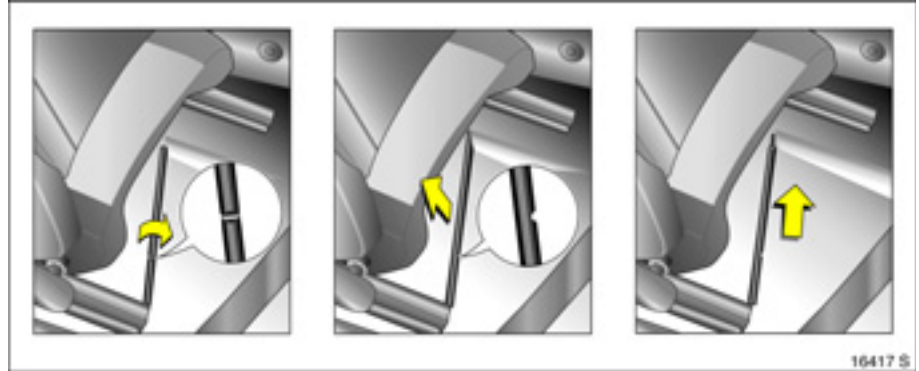

3. Turn the tool 90° to the right to remove.
4. Pull the front of the tool upward and out of the flooring.
5. Pull the tool forward out of the flooring.

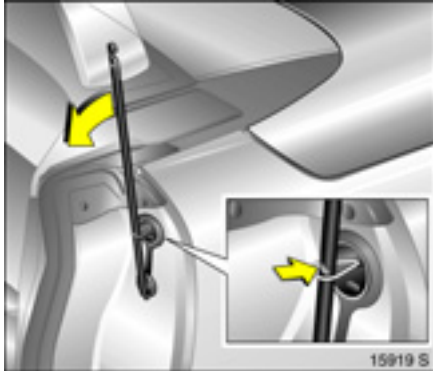

6. Open and fold down the cover of the emergency release cable. Pull the cable out slightly.
7. Insert the tool through the eye of the emergency release cable. Support the rounded end of the tool on the cover as illustrated. The eye of the emergency release cable must lie in the groove on the tool.

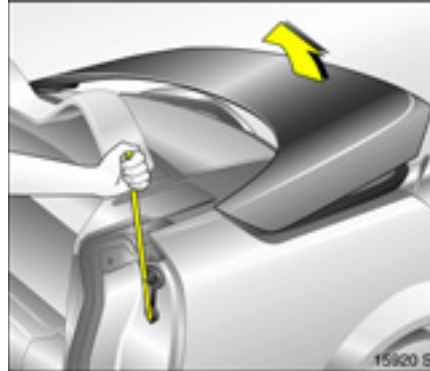

8. Have a second person hold the rear of the boot lid down. Pull the tool forward to release the lid at the rear.
9. Carefully open the boot lid by hand. Refit the emergency release cable in the opening and refit the cover. Do not close the vehicle door if the cover is open.

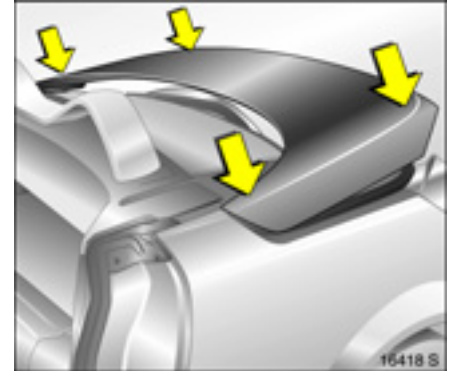

- To close the boot lid, have a second person help you press it down and engage it in the lock.
- Have the cause of the fault eliminated by a workshop.



## Vauxhall alarm system \*

Monitors:

- doors, luggage compartment, bonnet,
- the passenger compartment,
- vehicle tilt e.g. if it is raised,
- the ignition.

### To activate

All doors, windows, retractable steel roof, luggage compartment and bonnet must be closed. Press button  on the remote control.



If the ignition was switched on, the driver's door must be opened and closed once so that the anti-theft alarm system can be switched on.

**Activation without monitoring of passenger compartment and vehicle tilt e.g. if animals are to be left in the vehicle.**

1. The luggage compartment, retractable steel roof and bonnet must be closed.

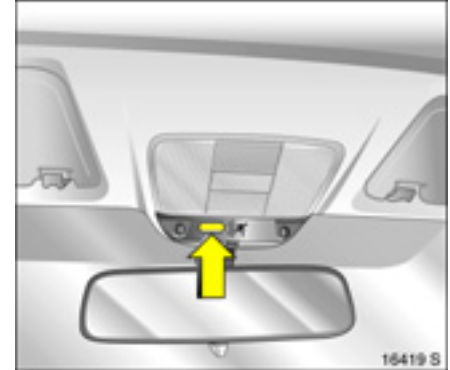

2. Press button in front of the courtesy lamp (with ignition off); LED in the hazard warning lamp button flashes a maximum of 10 seconds.
3. Close doors.
4. Activate the anti-theft alarm system. The LED in the hazard warning lamp button illuminates. After approx. 10 seconds, the anti-theft alarm system is activated without monitoring of the passenger compartment or vehicle tilt. The LED in the hazard warning lamp button flashes until the anti-theft alarm system is deactivated.

Passenger compartment monitoring is deactivated if the retractable steel roof is open to prevent false alarms.

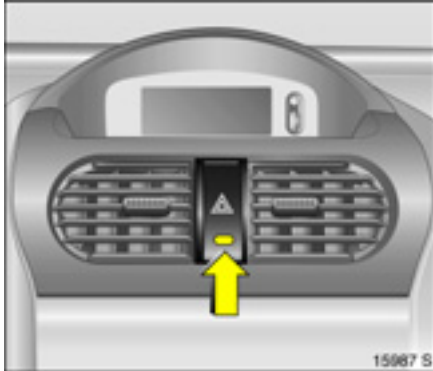

**Light emitting diode (LED)**

During the first 10 seconds of anti-theft alarm system activation:

- LED comes on = Test, switch-on delay,
- LED flashes = Door, luggage compartment or bonnet open, or system fault.

After the first 10 seconds of anti-theft alarm system activation:

- LED flashes = System switched on, slowly
- LED comes on for approx. 1 second = Switch-off function.

On faults, contact a workshop.



**To deactivate**

Press button  of the remote control

– or –

Switch on ignition.

In the event of a fault in the remote control, unlock vehicle with key  25.

If the alarm is triggered when the driver's door is opened, deactivate the anti-theft alarm system by switching on the ignition.

**Note**

- Changes to the vehicle interior, such as the use of seat covers, could impair the function of passenger compartment monitoring.
- Switch off passenger compartment monitoring if the interior of the parked vehicle is heated.

**Alarm**

When triggered, the alarm gives off an acoustic signal (horn) and a visual signal (hazard warning lamps). The number and duration of the alarms are stipulated by legislation.

The alarm can be silenced by pressing a button of the remote control or by switching on the ignition. The anti-theft alarm system is deactivated at the same time.

**Alarm siren with integrated battery \***

The alarm siren monitors the on-board voltage network and triggers an alarm if this network is manipulated (e.g. if the vehicle's battery is disconnected by unauthorised persons). The alarm siren has its own power supply and is therefore not dependent on the vehicle's battery.

If the vehicle's battery is to be disconnected (e.g. for maintenance work), the alarm siren must be deactivated as follows: switch the ignition on then off, disconnect the vehicle's battery within 15 seconds.

**To switch off alarm siren:**

Switch ignition on then off.

**Exterior mirrors****Adjust exterior mirrors**

Select corresponding exterior mirror and adjust with the four-way switch.

**Aspherical exterior mirror \***

The aspherical exterior mirror reduces the blind spot. The shape of the mirror makes objects appear smaller, so allowing the estimating of the distance of vehicles following to be only partly possible.

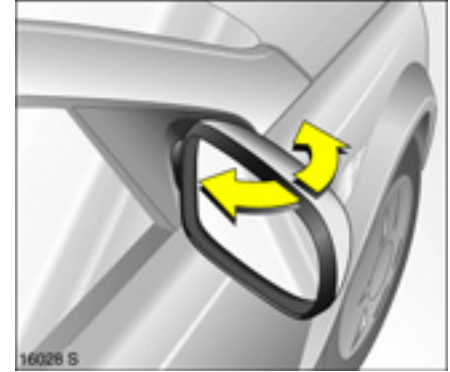
**Swinging in exterior mirror**

The exterior mirrors can be folded in by pressing gently on the outer edge of the housing.

For the safety of pedestrians, the exterior mirrors will swing out of their normal mounting position if they are bumped with sufficient force. Reposition the mirror by applying slight pressure to the mirror housing.



**Heated exterior mirrors \***

Heating is activated or deactivated by pressing the  button when the ignition is on.

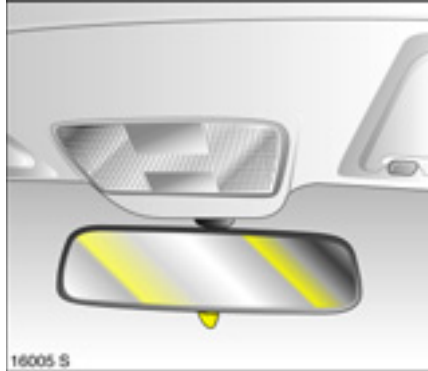

**Interior mirror**

To adjust, swivel mirror housing.

To reduce dazzle, swivel the lever on the underside of the mirror housing.

**Electric windows**

**⚠ Warning**

Exercise care when operating electric windows. Risk of injury, especially for children.

Vehicle passengers should be informed accordingly.

Keep a close watch on the windows when closing them. Ensure that nothing becomes trapped in them as they move.

**Ready for operation**

Ready for operation when the ignition is on

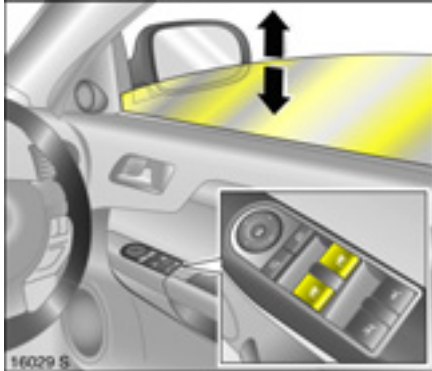

**Operation**

To operate window in stages, briefly pull or push relevant window switch. For automatic opening or closing, pull or push switch longer; push or pull switch again to stop movement.

Automatic closing is not possible during retractable steel roof operation.

When a door is opened, the window of that door opens slightly. It closes automatically after the door is closed.

When the retractable steel roof is opened or closed, the windows open slightly. They close automatically once the retractable steel roof is completely opened or closed.

**Safety function**

If the window glass encounters resistance above the middle of the window during automatic closing, it is immediately stopped and the window opened again.

If the windows do not move easily because of frost, for example, repeatedly tap the switch for the window in question until the window has been closed in stages.

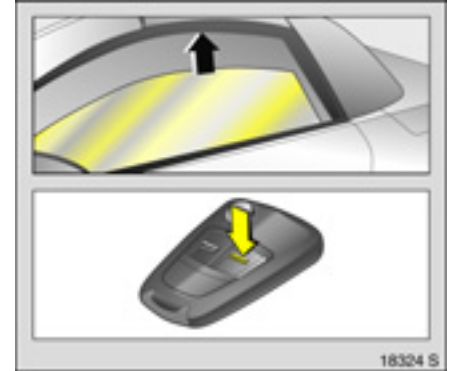

**Closing windows from outside**

Press button  on the remote control until the windows are fully closed.

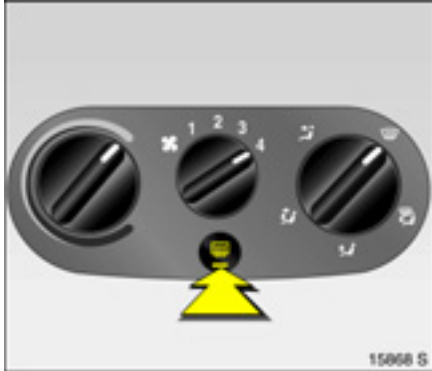

#### Heated rear window

Heating is activated or deactivated by pressing the  button when the ignition is on.

Climate control ⇨ 92.

#### Overload

If the windows are repeatedly operated at short intervals, the power supply is briefly cut off.

#### Fault

If the windows cannot be opened and closed automatically, activate the window electronics as follows:

1. Close doors.
2. Switch on ignition.
3. Close the window completely and hold the button depressed at least 5 seconds longer.
4. Open the window completely and hold the button depressed at least 1 second longer.
5. Repeat for each window.

#### Retractable steel roof

The retractable steel roof, a foldable steel top, enables the Tigra to combine the attributes of a coupe and a convertible.

#### Warning

Exercise care when operating the roof. Risk of injury.

Pay close attention to the roof's movement zone during operation. Make sure that nothing could become trapped.

Make sure no one is in the movement zone during roof operation. Risk of injury.

Before operating the roof in garages, parking garages or the like, check the amount of vertical clearance available.

Vehicle passengers should be informed accordingly.

Before leaving the vehicle, remove the ignition key in order to prevent unauthorised operation of the windows and sun roof.

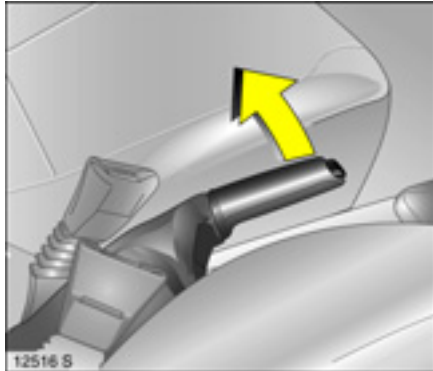

**Opening the roof**  
 Only with vehicle stationary.  
 Apply handbrake.

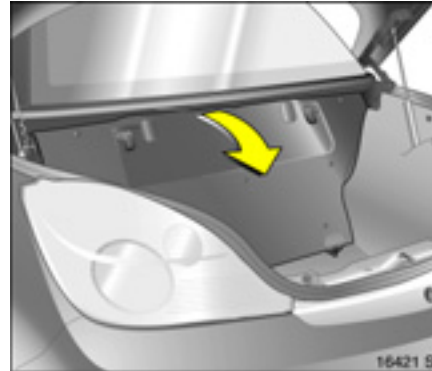

Engage the luggage compartment partition in the rear position.  
 Place no objects in front of the rear window or in front of the luggage compartment partition.  
 Close the boot lid ⇨ 26.

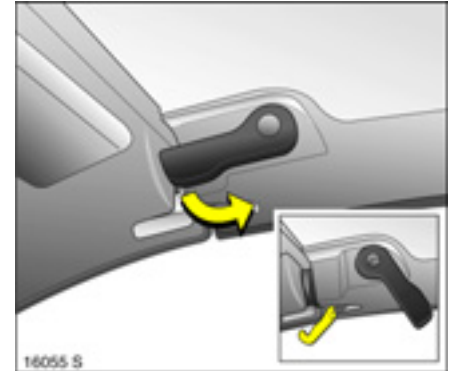

Release the locking levers on upper right and left of the window frames, pulling both levers all the way down. Both retaining hooks must unhook.

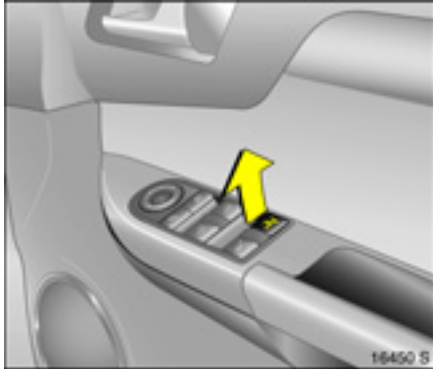

Switch on ignition.

Pull  until the roof is completely open and the boot lid is closed.

An acoustic signal sounds at the beginning and end of the procedure.

If the handbrake is not applied, the roof lock is not released or the luggage compartment partition is not folded back when button  is actuated, a warning buzzer sounds and the roof does not open.

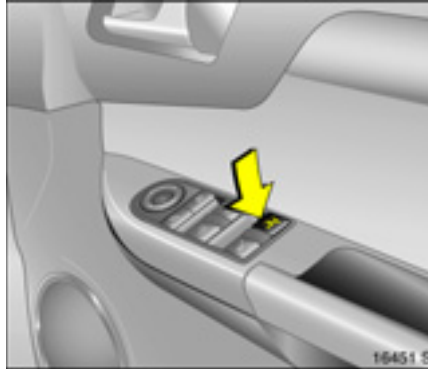

#### Closing the roof

Only with vehicle stationary and boot lid closed.

The luggage compartment partition must be engaged in its rear position. Do not place any objects in front of the luggage compartment partition.

Apply handbrake.

Switch on ignition.

Press  until the roof and boot lid are completely closed.

An acoustic signal sounds at the beginning and end of the procedure.

If button  is actuated when the handbrake is not applied, a warning buzzer sounds and the roof remains open.



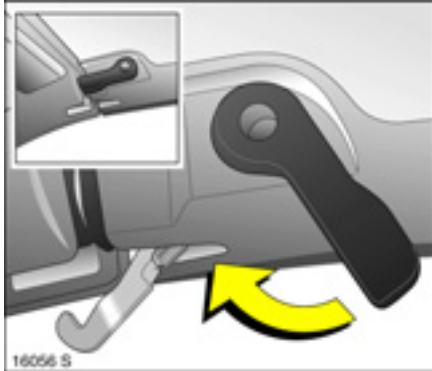

Push the locking levers on the right and left side of the window frame all the way up.

The retaining hooks engage in the corresponding recesses and the roof locks securely.

**Note**

- A warning buzzer sounds for 5 seconds after the handbrake is released and the vehicle starts off if the roof has not been properly closed or opened. Remedy this by stopping the vehicle and repeating the closing or opening procedure.
- Frequent operation of the roof with the engine switched off will discharge the battery.

**Fault**

Automatic roof operation is only functional if the roof has been properly closed or opened beforehand.

Check if:

- the handbrake is applied,
- the ignition is on,
- the luggage compartment partition is locked in the rear position,
- the boot lid is completely closed,
- the locking levers are unlocked.

If a fault occurs while the roof is opening or closing, the roof stops in its current position. A warning buzzer sounds after 2 minutes. After an additional minute, power to the system is cut-off. The roof then moves automatically back to the luggage compartment or toward the windscreen frame. In order to close completely, open both windows, remove the key and carry out the missing steps of the following description for loss of automatic drive.

If there is a fault in the automatic drive or loss of battery power, the fully opened roof can be manually closed as follows:

1. Park the vehicle and apply the handbrake.
2. Open both windows or open the doors.
3. Switch off the ignition and remove the key.
4. Open the luggage compartment. If the battery has become discharged or there is a malfunction in the boot lid, the lid must be opened manually ⇨ 27.

<b>⚠ Warning</b>
<p>Exercise care when operating the roof. Risk of injury. Risk of pinching.</p> <p>Make sure that nothing could become trapped.</p> <p>Vehicle passengers should be informed accordingly.</p> <p>Closing the roof manually requires 2 persons and the use of great care.</p>

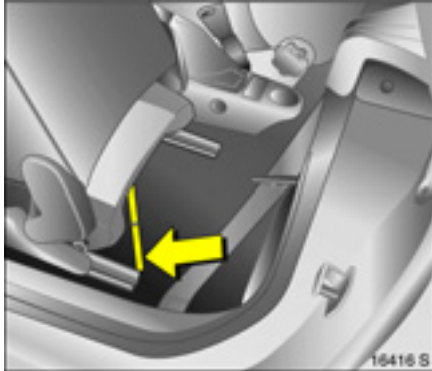

5. Fold down the seat backrest. The tool is fastened underneath the seat.

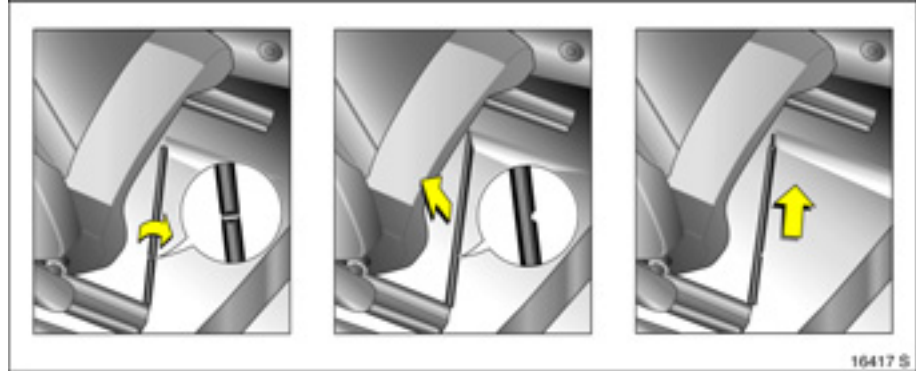

6. Turn the tool 90° to the right to remove.  
7. Pull the front of the tool upward and out of the flooring.

8. Pull the tool forward out of the flooring.

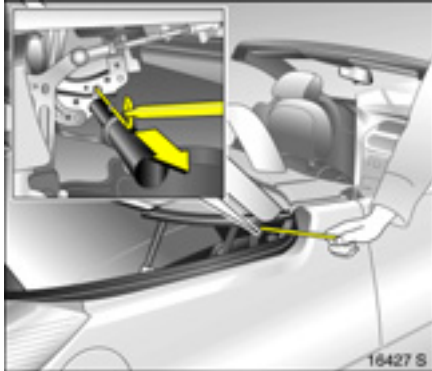

9. Use the tool to forcefully pull the lock bar to unlock the cover in front of the rear window. The lock bar is on the right side of the vehicle below the cover.

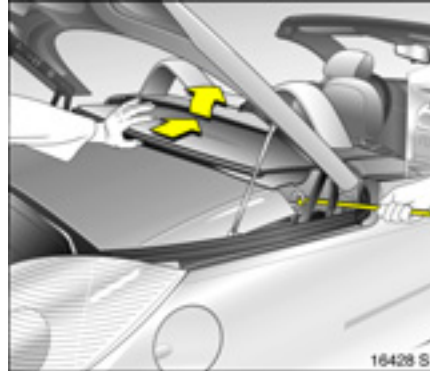

10. With the lock bar pulled, have a helper pivot the cover upward by hand. The noise arising from this is normal.



11. Press the button below the boot lid until the lid is completely closed  $\varnothing$  26.  
If this is not possible, force the boot lid closed again as illustrated; it must completely engage in the rear lock.

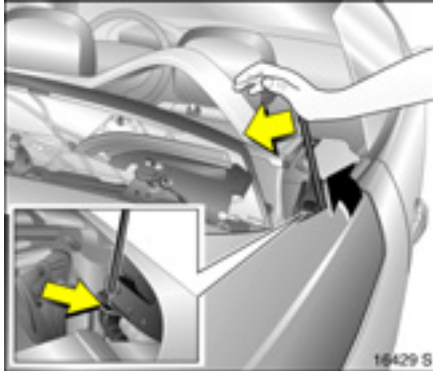

12. Release the front catches of the boot lid using the tool by inserting the tool in the guide and pressing the upper end inward; see illustration above. At the same time, pull the boot lid slightly upward out of the catch. Carry out the procedure on the right and left.



13. With two people working simultaneously on the right and left, open the boot lid rearward to its end position. Do not twist or tilt the boot lid when doing so.

**⚠ Warning**

Luggage compartment does not remain in open position.

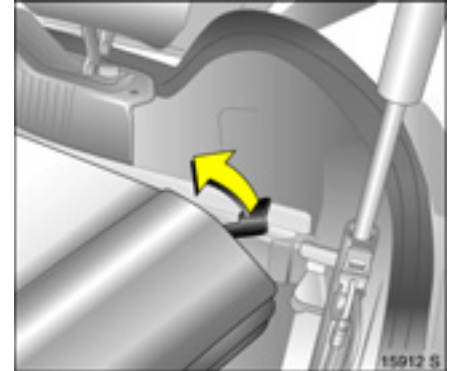

14. Release the roof retainer at the rear left of the luggage compartment partition by raising the release lever.

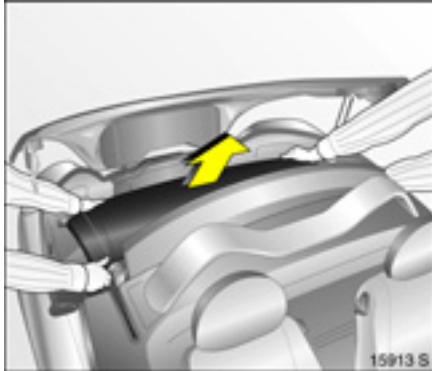

15. With the aid of a second person, carefully and slowly pull the roof upward. Grip the roof at the sides and pull forward. Make sure that the boot lid is completely open.

**⚠ Warning**

Caution. Risk of pinching.

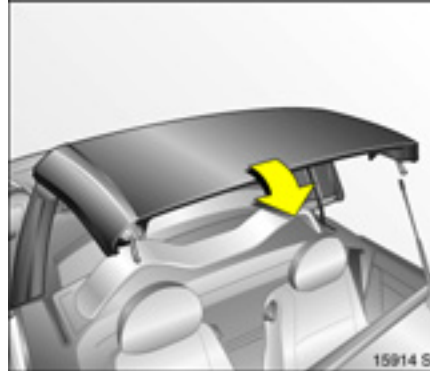

16. Pull the roof up to the windscreen frame.

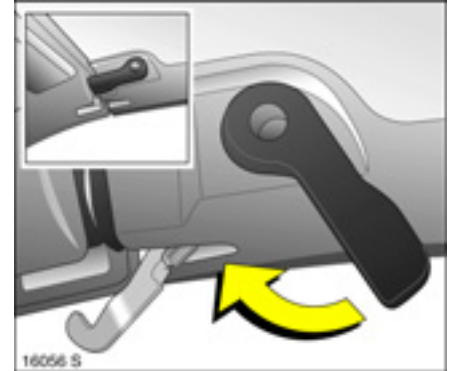

17. Push the locking levers on the right and left side of the window frame all the way up.

The retaining hooks must engage in the corresponding recess and the roof must securely lock.

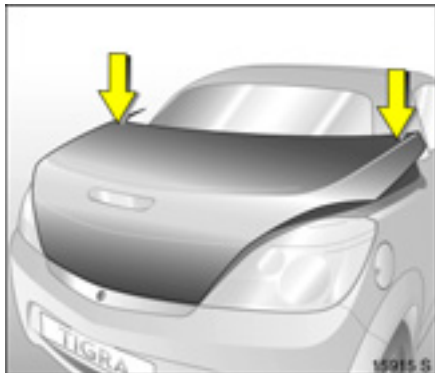

18. Have a second person help to force the boot lid closed simultaneously on the right and left. It must engage in the locks.

Do not twist or tilt the boot lid. The closed lid is not locked.

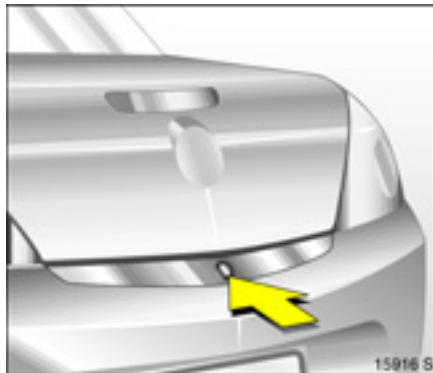

19. Next, if possible open and close the boot lid once using the button below the lid. The boot lid is then locked.

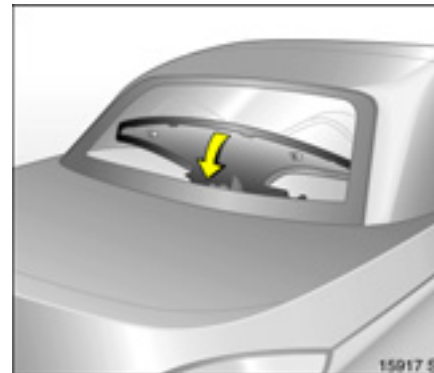

20. Press down the cover in front of the rear window.

It is not possible to open the roof if there is a malfunction in automatic operation.

Have the cause of the fault eliminated by a workshop.

**Wind deflector ✱**

Install the wind deflector to reduce wind turbulence, draught and noise in the passenger compartment when the retractable steel roof is open.

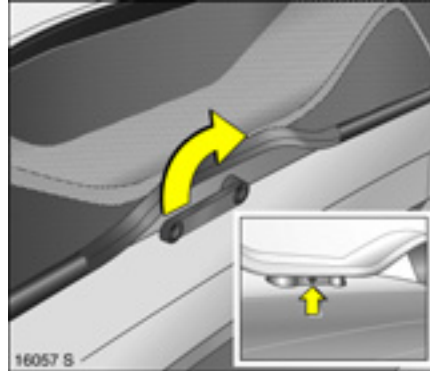

Insert the wind deflector in the opening in the centre of the rollover protection and fasten it with the crank.

When removed, store the wind deflector in the luggage compartment.

# Seats, Interior

Front seats .....	44
Head restraints .....	46
Luggage compartment partition .....	47
Three-stage safety system.....	48
Three-point seat belts .....	49
Belt tensioners.....	50
Using the belts.....	52
Child restraint systems * .....	53
Airbag system.....	54
Cigarette lighter *.....	63
Accessory socket *.....	63
Ashtray *.....	64
Stowage compartments.....	64
Coin holder *.....	65
Sun visors.....	65

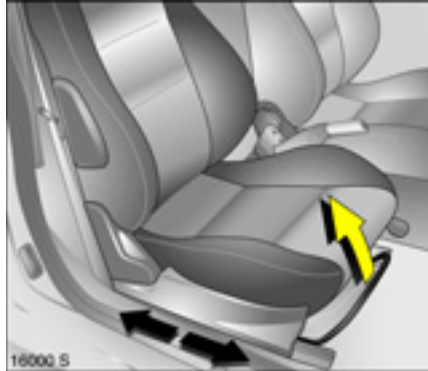

### Front seats

#### ⚠ Warning

Important: Do not sit nearer than 10 inches (25 cm) from the steering wheel, to permit safe airbag deployment.

Never adjust seats during driving, as they can move uncontrollably.

#### Adjust seat longitudinally

Pull the handle on the front seat, slide the seat and release the handle.

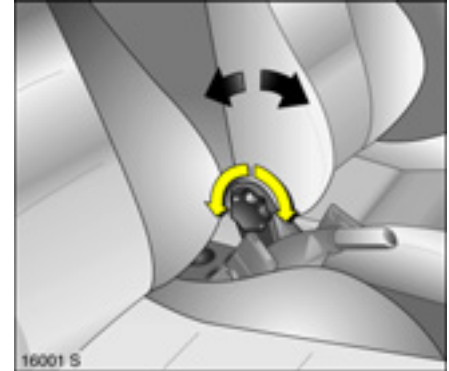

### Adjusting the backrest

Turn side handwheel on the seat while releasing the pressure on the backrest.



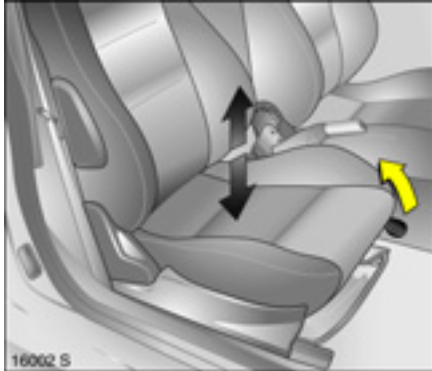

#### Adjusting the seat height

Lift lever and relieve some weight from seat to raise it or press down on seat with body weight to lower it.

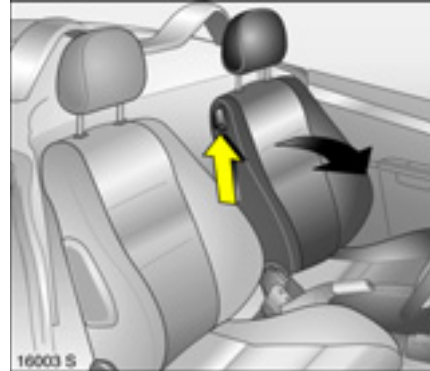

#### Fold backrest forward

To fold the backrest forwards, e.g. to reach the storage compartment behind the seats, lift release lever.



#### Seat position

##### **⚠ Warning**



Only drive with the seat correctly adjusted.

- Sit with your buttocks as far back against the backrest as possible. Adjust the distance between your feet and the pedals so that your legs are slightly angled when pressing the pedals. Slide the passenger seat as far back as possible.

- Sit with your shoulders as far back against the backrest as possible. Set the backrest rake so that you can easily reach the steering wheel with your arms slightly bent. Maintain contact between your shoulders and the backrest when turning the steering wheel. Do not angle the backrest too far back. We recommend a maximum rake of approx. 25°.
- Adjust the steering wheel ↻ 5.
- Set seat height ✱ high enough to have a clear field of vision on all sides and of all display instruments. There should be at least six inches of clearance between your head and the headlining. Your thighs should rest lightly on the seat without pressing into it.
- Adjust the head restraint.



**Heated seats ✱**

Two pushbuttons  in the centre console. For heating with ignition on, press button .

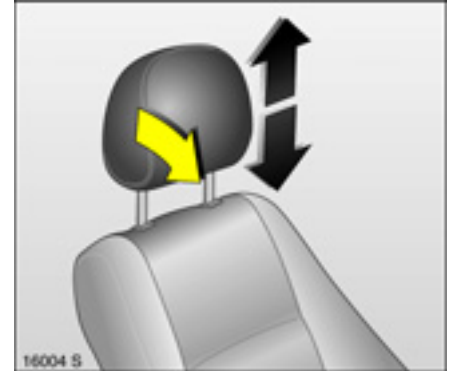

**Head restraints**

**Adjustment**

Tilt head restraints forwards, hold and adjust height. Allow head restraints to engage after adjustment.



**Head restraint position**

**⚠ Warning**

Only drive with the head restraint set to the proper position.

The middle of the head restraint should be at eye level. If this is not possible for extremely tall persons, set to highest position, and set to lowest position for small persons.

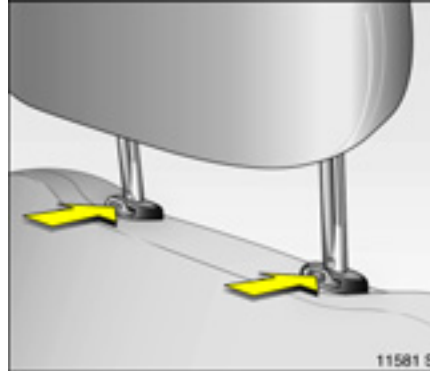

**Removing**

Press and release the two catches. Pull and remove the head restraint.

Stow head restraints securely in luggage compartment. Do not drive with head restraints removed if the seat is occupied.

**Note**

Only approved objects or components should be attached to the head restraint of the unoccupied front passenger seat.

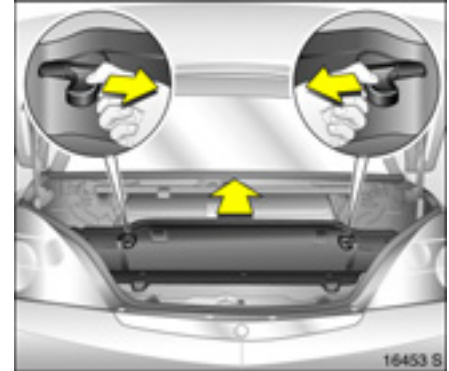

**Luggage compartment partition**

When the retractable steel roof is closed, the partition can be folded forward to enlarge the luggage compartment: pull both catches inward and fold the partition forward until it engages.

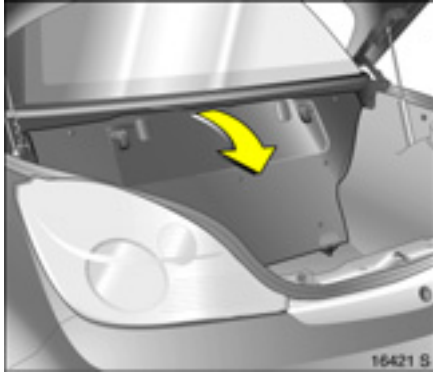

If the retractable steel roof is to be opened, pull the centre of the partition, release it and fold it rearward until it engages.

Place no objects in front of the luggage compartment partition.

### Three-stage safety system

Comprising:

- three-point seat belts,
- belt tensioners at the seats,
- airbag systems for driver and front passenger.

The three stages are activated in sequence depending on the severity of the accident:

- The automatic seat belt locking devices prevent the belt strap from being pulled out and thus ensure that the vehicle occupants are retained in their seats.
- The seat belts are pulled down at the belt buckles. This means the belts fit snugly, the occupants are decelerated early with the vehicle and the body loading is reduced.
- The airbag systems are also triggered in the event of severe accidents and form a safety cushion for the occupants.

#### Warning

The airbag systems serve to supplement the three-point seat belts and belt tensioners. The seat belts must therefore always be worn. Disregard of these instructions may lead to injuries or endanger life. Vehicle passengers should be informed accordingly.

Always follow the instructions provided with the child restraint system!



### Three-point seat belts

The seat belts have an automatic retractor, so that the belt is spring tensioned and always lies against the body.

Information on correct seat position ⇨ 45.

The seat belts are locked during heavy acceleration or deceleration of the vehicle. This prevents the belt from extending, keeping the occupant in their seat.

### ⚠ Warning

Fasten your seat belt before each trip.  
In the event of an accident, persons not wearing seat belts endanger their fellow occupants and themselves.

Seat belt control indicator 🚗\*⇨ 66.

Seat belts are designed to be used by only one person at a time. They are not suitable for anyone under 12 years of age or under 150 cm tall.

For children up to 12 years of age, we recommend the Vauxhall child restraint system ⇨ 53.

### Testing the seat belts

Check all parts of the belt system periodically for damage and function. Replace damaged components. After an accident, have the seat belts and triggered belt tensioners replaced by a workshop.

Make sure that seat belts are not damaged or trapped by sharp-edged objects.

### Belt tensioners

The seat belts are pulled down at the buckles on a front or rear impact above a certain severity. This tightens the belts.

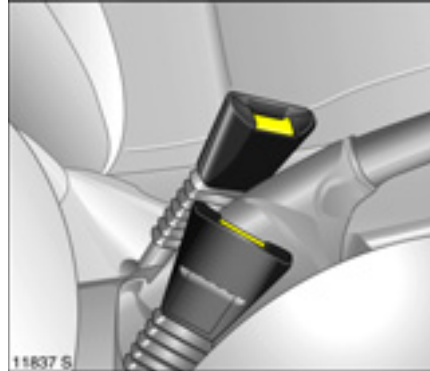



#### Actuation of belt tensioners

Indicated by continuous illumination of control indicator .

Triggered belt tensioners must be replaced by a workshop. Belt tensioners can only be triggered once.



#### Control indicator for belt tensioners

The function of the belt tensioners and airbag systems is monitored electronically and indicated by the control indicator . When the ignition is switched on, the control indicator illuminates for approx. 4 seconds. If it does not illuminate, or if it does not go out after 4 seconds, or if it illuminates whilst driving, there is a fault in the belt tensioner or airbag systems  58. The systems might not trigger in the event of an accident.

Deployment of the belt tensioners is indicated by continuous illumination of .

**⚠ Warning**

Have the cause of the fault eliminated by a workshop immediately.

Self-diagnosis integrated into the system allows rapid fault identification.

**Important**

- Do not affix or place accessories or other objects within the deployment zone of the belt tensioners. Do not make any modifications to belt tensioner components as this will invalidate the vehicle type approval.

**⚠ Warning**

Incorrect handling (e.g. removal or fitting of seat belts or belt buckles) can trigger the belt tensioners with risk of injury.

- The belt tensioner and airbag system control electronics can be found in the centre console area. In order to avoid malfunctions, do not store magnetic objects in this area.
- We recommend that you have the front seats removed by a workshop in the event of triggering of the airbags and belt tensioners.
- The belt tensioners trigger once only, indicated by the continuous illumination of the control indicator . Have a workshop replace triggered belt tensioners.
- When disposing of the vehicle, the safety instructions given for this must be observed. Take the vehicle to a recycling company for disposal.



## Using the belts

### Fitting seat belts

The seat belt must not be twisted and must lie snugly against the body. The backrest must not be tilted back too far (maximum approx. 25°).

Pull the belt out of the reel, guide it across the body (making certain it is not twisted) and engage the latch plate in the buckle. Tension the lap belt frequently whilst driving by tugging the shoulder belt.



### ⚠ Warning

On pregnant women in particular, the lap belt must be positioned as low as possible across the pelvis so as not to put too much pressure on the abdomen.

Loose or bulky clothing prevents the belt from fitting snugly. Do not place objects such as handbags or mobile phones between the belt and your body.

### ⚠ Warning

The belt must not rest against hard or fragile objects in the pockets of your clothing.



### Removing the belt

To release seat belt, press red button on belt buckle.



**Child restraint systems \***

Follow the usage instructions for the child restraint system.

Always comply with local or national regulations. In some countries, the use of child restraint systems is forbidden on certain seats.

**Selecting the right system**

Your child should travel facing backwards in the vehicle for as long as possible. A child has a very weak cervical spinal column and in the event of an accident is less likely to suffer injury in a rearward-facing, semi-lying position than if seated upright.

<b>⚠ Warning</b>
Never carry child restraint systems on your lap, risk of fatal injury.

**Permissible options for fitting a child safety seat**

<b>Weight and age class<sup>1)</sup></b>	<b>On the front passenger seat</b>
<b>Group 0: up to 10 kg</b> or approx. 10 months	
<b>Group 0+: up to 13 kg</b> or approx. 2 years	B <sup>1</sup>
<b>Group I: 9 to 18 kg</b> or approx. 8 months to 4 years	B <sup>1</sup>
<b>Group II: 15 to 25 kg</b> or approx. 3 to 7 years	
<b>Group III: 22 to 36 kg</b> or approx. 6 to 12 years	B <sup>1</sup>

<sup>1)</sup> We recommend the use of each system until the child reaches the upper weight limit.

B<sup>1</sup> = Limited, only with seat occupancy recognition system and Vauxhall child restraint system with transponders \*.

Move seat height \* to highest position. Move front passenger seat back as far as possible.

**Note**

- Children under 12 years or under 150 cm tall should only travel in an appropriate child safety seat.
- When transporting children, use the child restraint systems suitable for the child's weight.
- Check that the child restraint systems have been correctly installed – see instructions provided with child restraint system.
- The covers of Vauxhall child restraint systems can be wiped clean.
- Do not stick anything on the child restraint systems and do not cover them with any other materials.
- A child restraint system which has been subjected to stress in an accident must be replaced.
- Secure or remove child restraint systems carried in the vehicle when not in use.



## Airbag system



### Front airbag

The front airbag system consists of one airbag in the steering wheel and one in the instrument panel. These can be identified by the word **AIRBAG**.

The front airbag system comprises:

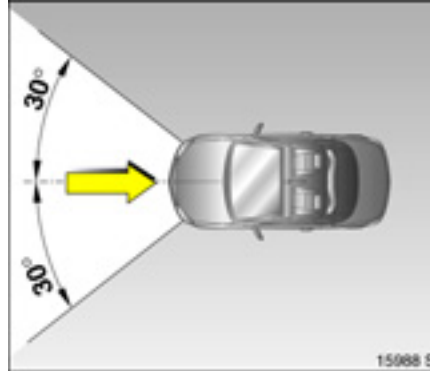
- an airbag with inflator in the steering wheel and a second one behind a trim panel above the glove compartment,
- the control electronics with impact sensors,
- control indicator for airbag systems  in the instrument cluster,







- seat occupancy recognition ,
- the control indicator for Vauxhall child restraint systems  with transponders  in the courtesy lamp.

The front airbag system will be triggered:

- depending on the severity of the accident,
- depending on the type of impact,
- within the range shown in the illustration,
- independently of the side airbag system.

The ignition must be on.

Exception:

Passenger seat with seat occupancy recognition system . The seat occupancy recognition system deactivates the front and side airbags for the front passenger seat if the seat is unoccupied or a Vauxhall child restraint system with transponders  has been fitted to the front passenger seat. Seat occupancy recognition –  58. Vauxhall child restraint system with transponders   59.

Examples of events triggering the front airbag system:

- Impact against a non-yielding obstacle: the front airbags are triggered at low vehicle speed.
- Impact against a yielding obstacle (such as another vehicle): The front airbags are only triggered at a higher vehicle speed.

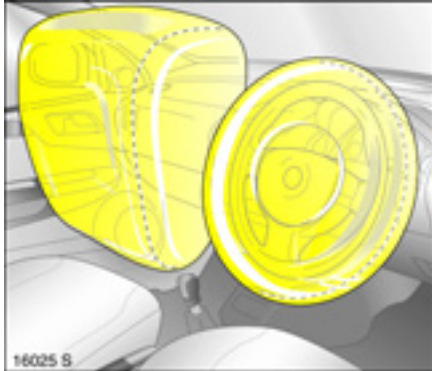

When triggered, the front airbags inflate in milliseconds and form a safety cushion for driver and front passenger. Forward movement is checked and the risk of injuries to the upper body and head thereby substantially reduced.

No impairment of view will occur, because the airbags inflate and deflate so quickly.



**⚠ Warning**

Optimum protection is only provided with the seat in the proper position ↗ 45.

Keep the area in which the airbag inflates clear of obstructions.

Wear the three-point seat belt properly fastened. The front airbag system is an additional safety device, not a replacement for your seat belt.



The front airbag system will not be triggered in the event of:

- the ignition being switched off,
- minor frontal collisions,
- accidents in which the vehicle overturns,
- collisions involving a side or rear impact, that is to say, if it would not be of benefit to the occupants.

In addition, the front airbag system will not be triggered for the front passenger in versions with seat occupancy recognition \* if:

- the front passenger seat is unoccupied,
- there is a properly mounted Vauxhall child restraint system with transponders \*. Seat occupancy recognition system ⇨ 58. Vauxhall child restraint system with transponders \* ⇨ 59.

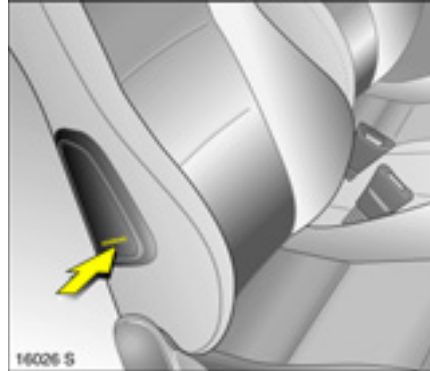

#### Side airbags

The side airbag system consists of an airbag in each front seat backrest. This can be identified by the word **AIRBAG**.

The side airbag system comprises:

- an airbag with inflator in the back of the driver's and front passenger seat respectively,
- the control electronics,
- the side impact sensors,
- control indicator for airbag systems \* in the instrument cluster,
- seat occupancy recognition \*,
- the control indicator for Vauxhall child restraint systems \* with transponders \* in the courtesy lamp.

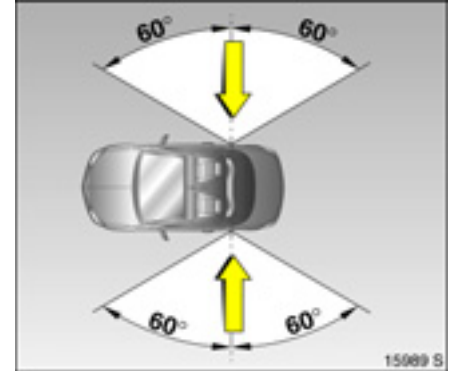

The side airbag system will be triggered:

- depending on the severity of the accident,
- depending on the type of impact,
- within the range shown in the illustration on the driver's or front passenger side,
- independently of the front airbag system.

The ignition must be on.

**Exception:**

Passenger seat with seat occupancy recognition system ✱. The seat occupancy recognition system deactivates the front and side airbags on the front passenger seat if the seat is unoccupied or a Vauxhall child restraint system with transponders ✱ has been fitted to the front passenger seat. Seat occupancy recognition – ⇨ 58. Vauxhall child restraint system with transponders ✱ ⇨ 59.

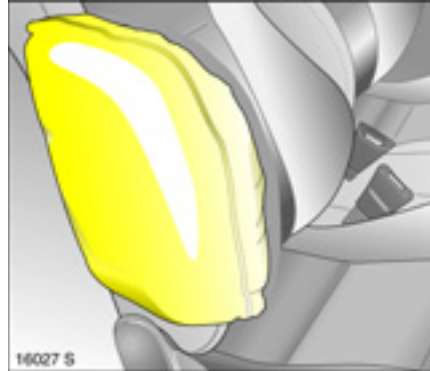

When deployed, the side airbag inflates within milliseconds and forms a safety cushion for the driver or front passenger in the respective front door area. This substantially reduces the risk of injury to the upper body and pelvis in the event of a side-on collision.

<b>⚠ Warning</b>
Keep the area in which the airbag inflates clear of obstructions.

The side airbags will not be triggered in the event of:





- the ignition being switched off,
- frontal collisions,
- accidents in which the vehicle overturns,
- collisions involving a rear impact,
- collisions involving a side impact outside the passenger cell.

In addition, the side airbag system will not be triggered for the front passenger in versions with seat occupancy recognition ✱ if:

- the front passenger seat is unoccupied,
- there is a properly mounted Vauxhall child restraint system with transponders ✱. Seat occupancy recognition ⇨ 58. Vauxhall child restraint system with transponders ✱ ⇨ 59.



#### Control indicator for airbag systems

The function of the airbag systems is monitored electronically together with the seat occupancy recognition  and the belt tensioners, and indicated by the control indicator . When the ignition is switched on, the control indicator illuminates for approx. 4 seconds. If it does not illuminate, does not go out after 4 seconds or illuminates whilst driving, there is a fault in the airbag systems, seat occupancy recognition  or in belt tensioners  50. The systems may fail to trigger in the event of an accident.

Deployment of the airbags is indicated by continuous illumination of .



#### Warning



Have the cause of the fault eliminated by a workshop immediately.

Self-diagnosis integrated into the system allows rapid fault identification.

#### Seat occupancy recognition

The seat occupancy recognition system deactivates the passenger front and side airbags if the front passenger seat is unoccupied or a Vauxhall child restraint system with transponders  has been fitted to the front passenger seat.

Control indicator  for seat occupancy recognition is located in the courtesy lamp. If control indicator  illuminates for approx. 4 seconds when the ignition is switched on, the vehicle is equipped with seat occupancy recognition  58, Fig. 12097 S.

If a Vauxhall child restraint system with transponders  is fitted, the control indicator  illuminates permanently after the ignition is switched on as soon as the system has detected the child restraint system. Only then may the child restraint system with transponders  be used on the passenger seat.



Vehicles with seat occupancy recognition can also be identified from the sticker on the passenger seat.

Vauxhall child restraint systems with transponders \* are automatically detected if correctly fitted to the front passenger seat. The front and side airbag systems for the front passenger seat are deactivated when these child restraint systems are used. It is essential to observe the seat occupancy recognition \* control indicator ⇨ 58.

### ⚠ Warning

Only Vauxhall child restraint systems with transponders \* should be fitted on the front passenger seats. Use of systems without transponders poses a risk of fatal injury.

Vauxhall child restraint systems with transponders \* can be identified by a sticker or badge.

#### Control indicator 🚗\* for Vauxhall child restraint systems with transponders \*

The presence of a Vauxhall child restraint system with transponders \* is indicated after the ignition has been switched on by continuous illumination of the control indicator 🚗\* in the courtesy lamp, as soon as the seat occupancy recognition system has detected the child restraint system.



If the control indicator does not illuminate during driving, the front and side airbags for the front seat passenger are not deactivated and there is a risk of fatal injury to the child. Have a workshop eliminate the cause of the fault.

If the child restraint system is not correctly installed or the transponders are defective, the turn signal lamp will flash. Check for correct child restraint system installation. For installation of child restraint system with transponders \* – see instructions provided with child restraint system.

If the control indicator flashes when the child restraint system with transponders \* is correctly fitted, there is a fault and a danger to the child. Have the cause of the fault eliminated by a workshop.

If no Vauxhall child restraint system with transponders \* is fitted, the control indicator must not illuminate or flash as the passenger airbag systems would not deploy. Have the cause of the fault eliminated by a workshop.

#### **Warning**

If the Vauxhall child restraint system with transponders \* has been fitted according to the instructions, the control indicator for Vauxhall restraint systems with transponders must illuminate in the courtesy lamp when the ignition is switched on.

If the control indicator does not illuminate during driving, the front passenger airbag systems are not deactivated and there is a risk of fatal injury. Have a workshop eliminate the cause of the fault.

#### **Important**

- Owing to the risk of injury when the airbags deploy, accessories and objects must not be placed within the expansion range of the airbag systems.
- Do not place any objects between the airbag systems and the vehicle occupants; danger of injury.

#### **Warning**

Never carry child restraint systems or other objects on your lap - risk of fatal injury.

- The airbag systems and belt tensioner control electronics can be found in the centre console area. In order to avoid malfunctions, do not store magnetic objects in this area.
- Do not stick anything on the steering wheel, instrument panel, seat backrests or roof frame in the vicinity of the airbags, or on the front passenger's seat cushion, or cover any of those areas with other materials.

- Use only a dry cloth or interior cleaner to clean the steering wheel, instrument panel, seat backrests and seat cushion of the front passenger seat. Do not use any aggressive cleaning agents.
- Only protective covers which are approved for your vehicle with side airbag may be fitted on the seats. When fitting the protective covers, make sure that the airbag units on the outboard sides of the seat backrests are not covered.
- The airbag systems are triggered independently of one another depending on the severity of the accident and type of impact.
- Each airbag deploys once only. Have a workshop replace deployed airbags immediately.
- The speeds, directions of movement and deformation properties of the vehicles, and the properties of the obstacle concerned, determine the severity of the accident and triggering of the airbags. The degree of damage to your vehicle and the resulting repair costs alone are not indicative that the criteria for triggering of the airbags were met.



- Do not perform any alterations on the components of the airbag system, as this would render the vehicle unroadworthy.

**⚠ Warning**

If handled improperly the airbag systems can be triggered in an explosive manner – risk of injury!

- We recommend entrusting removal of the steering wheel, the instrument panel, all panelling parts and the seats to a workshop in the event of triggering of the airbags and belt tensioners.
- When disposing of the vehicle, the safety instructions given for this must be observed. Take the vehicle to a recycling company for disposal.

- In vehicles with seat occupancy recognition ✳ persons weighing less than 35 kg must not be transported. This does not apply to children that are being transported in child restraint systems with transponders ✳.

- In vehicles with seat occupancy recognition ✳, do not place any heavy objects on the front passenger seat otherwise the airbag systems for the front passenger seat may be triggered in the event of an accident.

- In vehicles with seat occupancy recognition ✳, to prevent malfunctions do not use protective covers or seat cushions on the front passenger seat.

- When using a Vauxhall child restraint system with transponders ✳ on the front passenger seat, in order to prevent malfunctions, no objects (e.g. plastic sheet, stickers or heated mats) may be placed under the child restraint system.

**⚠ Warning**

Passengers must never carry child restraint systems and other objects on their laps. If carried in this way, child restraint systems with transponders ✳ in vehicles with seat occupancy recognition ✳ could prevent the front passenger airbag systems from being triggered in the event of an accident.



Use of child restraint systems \* on the front passenger seat of vehicles without seat occupancy recognition \*

**⚠ Warning**

No child restraint system \* may be installed on front passenger seat. Danger to life.



Seat occupancy recognition \* ⇨ 58.



Use of a child restraint system \* on the front passenger seat of a vehicle with seat occupancy recognition \*

**⚠ Warning**

Only Vauxhall child restraint systems with transponders \* can be fitted on the front passenger seats. Use of systems without transponders poses a risk of fatal injury.

Vehicles with seat occupancy recognition can be identified by control indicator \* in the courtesy lamp. If control indicator \* illuminates for approx. 4 seconds when the ignition is switched on, the vehicle is equipped with seat occupancy recognition ⇨ 58.

Seat occupancy recognition in a vehicle is also indicated by a sticker on the front passenger seat – see page Fig. 12106 A.

The seat occupancy recognition system detects Vauxhall child restraint systems with transponders \* and deactivates the front and side airbags for the front passenger seat. Seat occupancy recognition ⇨ 58.

Vauxhall child restraint systems with transponders \* can be identified by a sticker or badge.

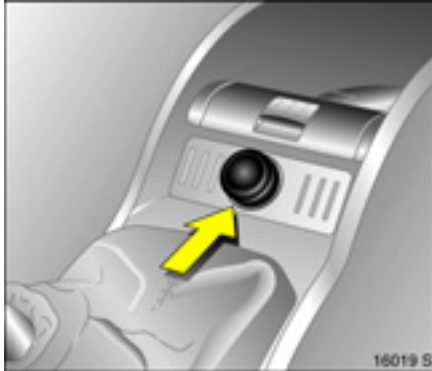

**Cigarette lighter \***

The cigarette lighter is in the centre console.

Press in cigarette lighter with ignition switched on. Switches off automatically when element is glowing. Withdraw cigarette lighter.

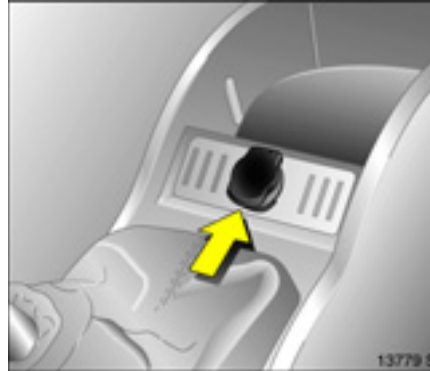

**Accessory socket \***

The accessory socket is in the centre console.

The accessory socket is ready for use when the ignition is switched on. Use of the socket while the engine is not running will drain the battery.

Do not exceed the maximum power consumption of 120 watts.

Electrical accessories connected to the socket must comply with the electromagnetic compatibility requirements laid down in DIN VDE 40 839, otherwise vehicle malfunctions may occur.

Do not connect any current-delivering accessories, e.g. electrical charging devices or batteries.

**Caution**

Do not damage the sockets by using unsuitable plugs.

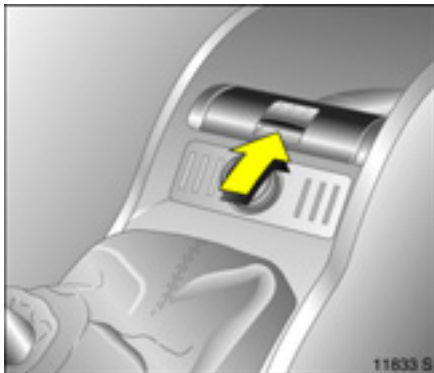

### Ashtray \*

<b>Caution</b>
To be used only for ash and not for combustible rubbish.

Open the ashtray cover to the resistance point.



To empty, open the ashtray cover fully beyond its resistance point, causing the insert to lift. Grip both sides of the ashtray insert and pull upwards.

To enlarge the storage compartment remove the ashtray completely.

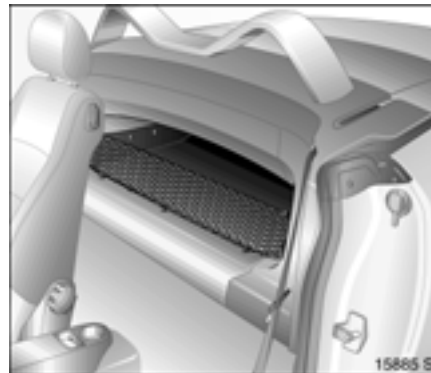

### Stowage compartments

#### Stowage compartment behind the seats

The compartment is only suitable for stowing light objects. Maximum load: 10 kg.

<b>⚠ Warning</b>
Secure objects to prevent them from falling out and causing injury while driving. The load must not hinder pedal, handbrake or gearshift operation or impair the driver in any way.

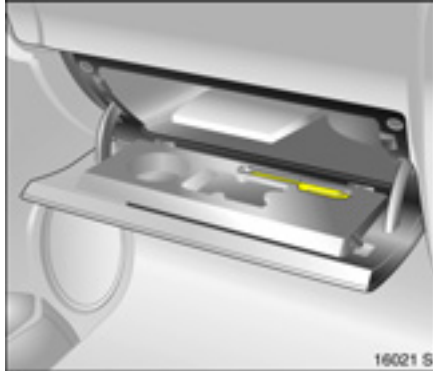

**Glove compartment**

To open, pull handle upwards.

Can be locked with the vehicle key.

On the inside of the glove compartment cover there is a pen holder.

The glove compartment should be closed while the vehicle is in motion.

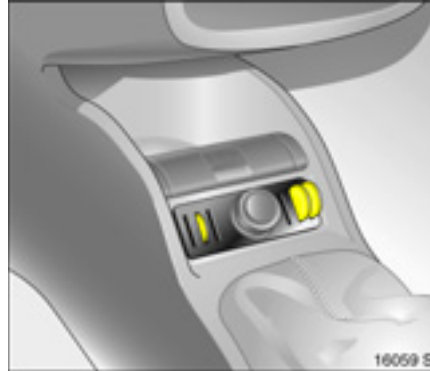

**Coin holder\***

In the centre console.

**Sun visors**

Use the sun visor to protect from glare by pulling it down and swivelling it to the side.

# Instruments, Controls

Control indicators ..... 66  
 Instrument display ..... 72  
 Information display ..... 74  
 Warning buzzers..... 84  
 Windscreen wipers..... 85



## Control indicators

The control indicators described here are not present in all vehicles. The descriptions however, apply to all instrument versions.

The control indicator colours mean:

- Red Danger, important reminder,
- Yellow Warning, note, fault
- Green On confirmation,
- Blue On confirmation,



### Seat belt \*

Control indicator illuminates red.

Illuminates after turning on the ignition (with warning tone) until the seat belt is applied.

Fasten seat belt ⇨ 52.



### Front fog lamps \*

Control indicator illuminates green.

Illuminates when the front fog lamps are on ⇨ 87.



**Engine electronics, transmission electronics, immobiliser, diesel fuel filter** ✱  
Control indicator illuminates or flashes yellow.

It illuminates for a few seconds when the ignition is switched on.

Illuminated when the engine is running  
Fault in engine or transmission electronic system. Electronics have switched to the emergency running programme. Fuel consumption may be increased and the vehicle's driveability reduced, see page ↻ 112. If the fault cannot be eliminated by restarting, contact a workshop immediately.

For vehicles with diesel engine, the diesel fuel filter may need to be drained of water ↻ 162.

If it flashes when the ignition is on  
Fault in the electronic immobiliser system; the engine cannot be started ↻ 21.



### Exhaust emission

Control indicator illuminates or flashes yellow.

It illuminates when the ignition is switched on and goes out shortly after the engine starts.

Illuminated when the engine is running  
Fault in emission control system. The permitted emissions may be exceeded. Contact a workshop immediately.

If it flashes when the engine is running:  
Fault that could lead to catalytic converter damage. Ease up on the accelerator pedal until the flashing stops ↻ 112. Seek the immediate assistance of a workshop.



 **Airbag systems ✱, Belt tensioners**  
Control indicator illuminates red.

Illuminated when the engine is running  
Fault in the airbag or belt tensioner systems ⇨ 50, ⇨ 58.

 **Engine oil pressure**  
Control indicator illuminates red.

Illuminates when the ignition is switched on and goes out shortly after the engine starts.

Illuminated when the engine is running

**Caution**

Engine lubrication may be interrupted. This may result in damage to the engine and/or locking of the drive wheels.

1. Move out of the flow of traffic as quickly as possible without impeding other vehicles.
2. Depress clutch.
3. Move gearshift lever to neutral, or with Easytronic ✱ place selector lever in N.
4. Switch off ignition.

**Warning**

When the engine is off, considerably more force is needed to brake and steer. Do not remove key until vehicle has come to a standstill, otherwise the steering column lock could engage unexpectedly.

Check engine oil level before contacting a workshop.





**Turn signal lamps**

Control indicator flashes green.

The control indicator flashes if a turn signal or the hazard warning lamps are activated.

Rapid flashing: failure of a turn signal lamp or associated fuse.

Replacing bulbs ⇨ 144. Fuses ⇨ 140.



**Main beam**

Control indicator illuminates blue.

Illuminated when main beam is on and during headlamp flash ⇨ 9, ⇨ 87.



**Easytronic ⚙️, Start engine**

Control indicator illuminates yellow.

The engine can only be started if the footbrake is depressed. If the footbrake is not depressed, the control indicator illuminates ⇨ 101.



**Preheating for diesel engines ⚙️**

Control indicator illuminates yellow.

Preheating activated. Only activates when outside temperatures are low.



**Winter programme of Easytronic ⚙️**

Control indicator illuminates yellow.

Control indicator is illuminated when Winter programme is enabled ⇨ 103.



**Fog tail lamp**

Control indicator illuminates yellow.

Illuminates when the fog tail lamp is on ⇨ 87.



**Alternator**

Control indicator illuminates red.

Illuminates when the ignition is switched on and goes out shortly after the engine starts.

Illuminated when the engine is running

Stop, switch off engine. Battery is not charging. Contact a workshop immediately.



**(D)**  
**Brake system, clutch system**  
 Control indicator illuminates or flashes red.

Illuminated  
 Illuminates when the ignition is switched on if the handbrake is applied ⇨ 119.

Illuminates when the handbrake is released if the fluid level for the brake or clutch system is too low ⇨ 164.

**⚠ Warning**

Stop. Do not continue your journey.  
 Consult a workshop.

Flashes  
 On vehicles with Easytronic \*, control indicator (D) flashes for a few seconds after the ignition is switched off if the handbrake has not been applied.

**(ABS)**  
**Anti-lock Braking System (ABS) \***  
 Control indicator illuminates red.

Illuminated while driving  
 Fault in ABS ⇨ 120.



**Engine oil level \***  
 Control indicator illuminates yellow.

The engine oil level is checked automatically.

Illuminated when the engine is running  
 Engine oil level too low. Check engine oil level and top up engine oil if necessary ⇨ 160.

**EPS<sup>1)</sup>**  
**Electric Power-assisted Steering (EPS)**  
 Control indicator illuminates yellow.

Fault in EPS. Vehicle can still be driven, but greater force is required for steering. Contact a workshop immediately.

<sup>1)</sup> **EPS** = Electric Power-assisted Steering.

**Electronic Stability Programme****(ESP®<sup>Plus</sup>) \***

Control indicator flashes or illuminates yellow.

Flashing during driving

System engages ⇨ 114.

Illuminated while driving

Fault in system ⇨ 114.

**Fuel level**

Control indicator illuminates or flashes yellow.

Illuminated

Fuel level in fuel tank is too low. Refuel.

Flashing

Fuel supply exhausted, refuel immediately.

Never let the tank run dry!

Erratic fuel supply can cause catalytic converter to overheat ⇨ 112.

Diesel engines: Bleed fuel system after running empty ⇨ 126.

**Seat occupancy recognition \***

⇨ 58, ⇨ 59.



## Instrument display

### Tachometer

Displays the engine rpm.

Drive in a low engine speed range for each gear as much as possible.

### Caution

If the pointer is in the warning zone, the maximum permitted engine speed is exceeded. Engine at risk.

### Speedometer

Speed display.

### Mileage display

If the ignition is off, the mileage is displayed for approx. 15 seconds by briefly pressing the reset knob.

Top line:

#### Trip odometer

Display of miles covered since reset.

To reset, hold the reset knob depressed for a few seconds with the ignition on.

Bottom line:

#### Odometer

Records the miles counted.

Service and maintenance ⇨ 152.



### Coolant temperature display

Coolant temperature display.

- Pointer in zone at left = Engine operating temperature not yet reached
- Pointer between the zones = Normal operating temperature
- Pointer in red zone = Temperature too high: Stop vehicle and switch off engine. Danger to engine. Check coolant level ⇨ 163.

For physical reasons, the engine temperature gauge shows the coolant temperature only if the coolant level is adequate.

During operation the system is pressurised. The temperature may therefore rise briefly to over 100 °C.



### Fuel gauge

Display of fuel level in tank

When fuel level is low, control indicator  illuminates. If the control indicator flashes, refuel immediately.

Never run the tank dry!

Because of the fuel remaining in the tank, the amount of fuel required to fill the tank may be less than the specified tank capacity.



### Transmission display ✱

Display of current gear or mode with Easytronic ✱:

- R** Reverse gear.
- N** Neutral.
- A** Automatic mode on Easytronic.
- 1-5** Manual mode, current gear on Easytronic.

Easytronic ✱ ⇨ 100.



### Service display ✱

When the indicator **InSP** in the odometer display illuminates, make a service appointment with a workshop as soon as possible.

Service and maintenance ⇨ 158.



### Information display

#### Triple information display ✳

Display of time, outside temperature and date/Infotainment system (when it is on).

When the ignition is off, the time, date and outside temperature can be displayed by briefly pressing one of the two buttons adjacent to the display.

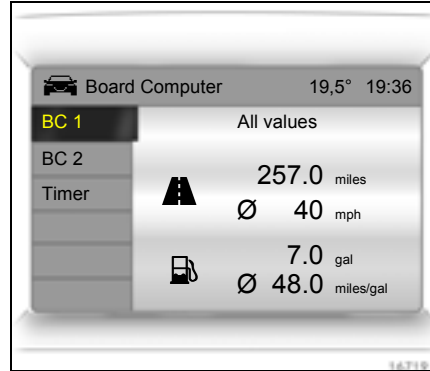

### Graphical Information Display ✳

Display of time, outside temperature and date/Infotainment system (when it is on).

The type of information and how it is displayed depend on the equipment of the vehicle and the settings made.

Some information appears in the display in an abbreviated form.



### Outside temperature

A fall in temperature is indicated immediately and a rise in temperature after a time delay.

If the external temperature falls to 3 °C, to warn of ice on the road the symbol ❄️ appears in the triple information display. When the temperature climbs, the symbol ❄️ goes out above 5 °C.



In vehicles with graphical information display ❄️, the warning message **Slippery road** is shown in the display as a warning for icy road surfaces. No message is displayed at temperatures below -5 °C.

### ⚠️ Warning

Caution: The road surface may already be icy even though the display indicates a few degrees above 0 °C.

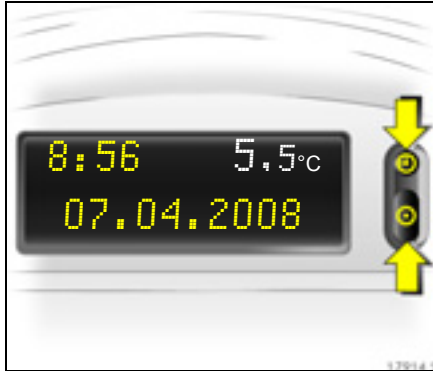

### Triple information display

#### Set date and time

The Infotainment system \* must be off. Activate setting mode by holding the  $\ominus$  button depressed for approx. 2 seconds. The flashing value is adjusted using the  $\ominus$  button. The  $\ominus$  button is used to switch to the next unit and to exit setting mode.

#### Automatic time synchronisation \*

The RDS signal of most VHF transmitters automatically sets the time. This can be identified by  $\text{Ⓜ}$  in the display.

Some transmitters do not send a correct time signal. In such cases, we recommend that you switch off automatic time synchronisation.

Activate setting mode and set it to year setting. Hold the  $\ominus$  button depressed approx. 3 seconds until  $\text{Ⓜ}$  flashes in the display and "RDS TIME" appears. The function is activated (RDS TIME 1) or deactivated (RDS TIME 0) with the  $\ominus$  button. Exit setting mode using the  $\ominus$  button.

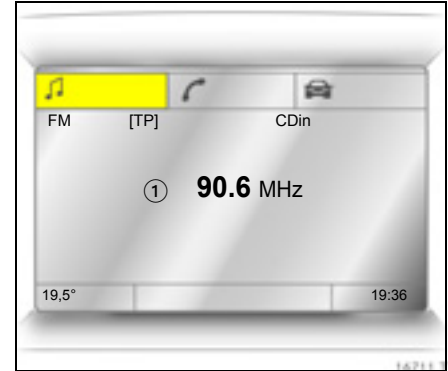

### Graphical information display \*, Selecting functions

The graphical information display depicts functions and their menus.

These functions are marked or executed in the menu display via the four-way switch, the multifunction knob \* on the Infotainment System or buttons \* on the steering wheel.





#### To select with four-way button

Select menu items via menus and with the buttons/four-way button of the Infotainment system.



#### Selection with the multifunction knob \*

Turn the multifunction knob to highlight menu items or commands and to select function areas.

Press the multifunction knob to select the highlighted item or confirm a command.

To exit a menu, turn the multifunction knob left or right to **Return** or **Main** and select.



#### Selection using buttons \* on steering wheel

Select menu options via menus and with the buttons.

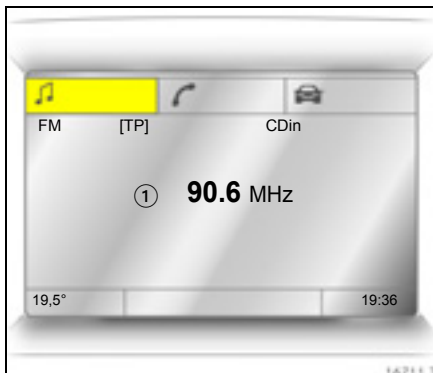

#### Function areas

For each functional area there is a main page (Main), which is selected at the top edge of the display (not with the Infotainment System CD 30 without the hands-free mobile phone system):

- Audio,
- Navigation ✱,
- Telephone ✱,
- Trip computer ✱.

Function areas audio, navigation ✱ and telephone ✱ – see Infotainment system instructions.



#### System settings

The settings are accessed via the **Settings** menu.

Press the **Main** button ✱ (not found on all Infotainment systems) on the Infotainment system (call up main display).

Press the **Settings** button on the Infotainment system. For Infotainment System CD 30, no menu may be selected.

The **Settings** menu is displayed.

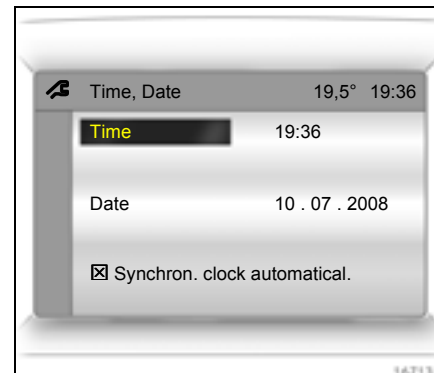

#### Setting the date and time ✱

Select menu item **Time, Date**, from the **Settings** menu.

The menu for **Time, Date** is displayed.

Select the required menu item and make setting.

**Automatic time synchronisation \***

The RDS signal of most VHF transmitters automatically sets the time.

Some transmitters do not send a correct time signal. In such cases, we recommend that you switch off automatic time synchronisation.

On Infotainment systems with navigation \*, time and date are also harmonised upon receipt of a GPS satellite signal.

The function is activated by ticking the field in front of **Synchron. clock automatical.** in the **Time, Date** menu.

**Language selection**

You can select the display language for some functions.

Select menu item **Language** from the **Settings** menu.

The available languages are displayed.

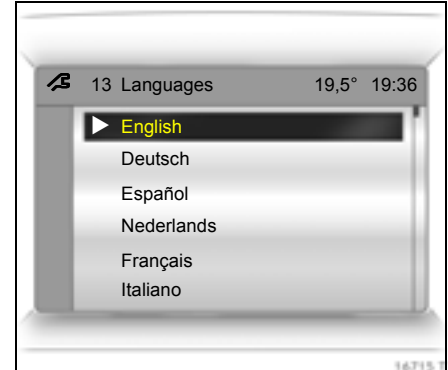

Select the required language.

Selections are indicated by a ► in front of the menu item.

In systems with voice output \*, when the language setting of the display is changed the system will ask whether the announcement language should also be changed – see Infotainment system instructions.

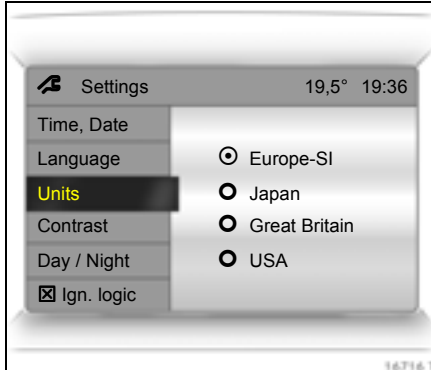

#### Setting units of measure

Select menu item **Units** from the **Settings** menu.

The available units are displayed.

Select the required unit.

Selections are indicated by a ● in front of the menu item.

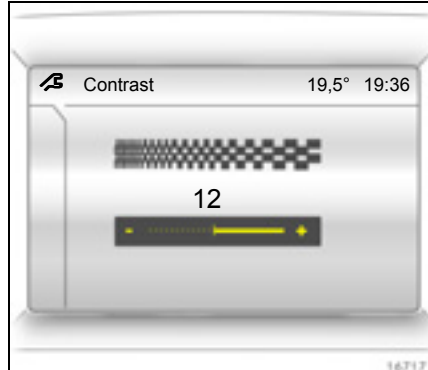

#### Adjust contrast

Select menu item **Contrast** from the **Settings** menu.

The menu for **Contrast** is displayed.

Confirm the required setting.

#### Setting display mode \*

Display brightness is independent of vehicle lighting. Settings are made as follows:

Select menu item **Day / Night** from the **Settings** menu.

The options are displayed.

**Automatic:** adapted based on vehicle lighting.

**Always day design:** Black text on light background.

**Always night design:** White text on dark background.

Selections are indicated by a ● in front of the menu item.

#### Ignition logic \*

Adjustment, see Infotainment system instructions.

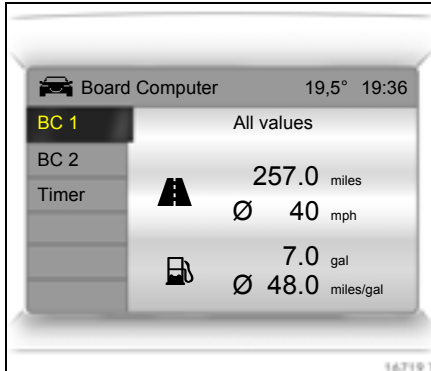

### Graphical information display ✱, Trip computer ✱

The trip computers provide information on driving data, which is continually recorded and evaluated electronically.

The on-board computer main page gives information on range, momentary consumption and average consumption ✱.

To display the other trip computer driving information, press **BC** button on Infotainment system ✱ or select trip computer menu on display.

For vehicles with Infotainment System CD 30 ✱ and steering wheel remote control ✱, the left steering wheel buttons only operate the trip computer.

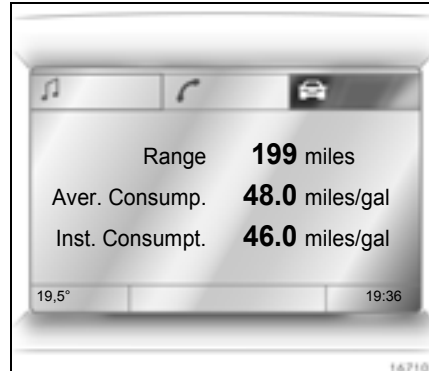

### Range

Range is calculated from current fuel tank content and instantaneous consumption. The display shows average values.

After refuelling, the vehicle updates the range automatically after a brief delay.



If the fuel in the tank will allow less than 30 miles (50 km) of travel, the message **Range** appears in the display.

If the fuel in the tank will allow less than 20 miles (30 km) of travel, the message **Please refuell!** ✱ appears in the display.

Acknowledge warning message ⇨ 76.

**Instantaneous consumption**

Display of current consumption. At low speeds, consumption per hour is displayed.

**Distance travelled**

Display of distance travelled. The measurement can be reset at any time.

**Average speed**

Display of average speed. The measurement can be reset at any time.

Stoppages in the journey with the ignition off are not included in the calculations.

**Effective consumption**

Display of fuel consumed. The measurement can be reset at any time.

**Average consumption**

Display of average consumption. The measurement can be reset at any time.

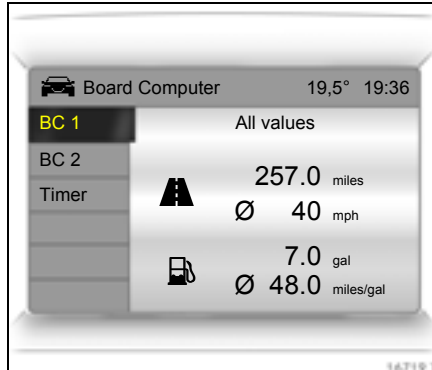

### Restart trip computer

The measurement or calculation of the following trip computer information can be restarted:

- distance travelled,
- average speed,
- effective consumption,
- average consumption.

Select **BC 1** or **BC 2** from the trip computer menu.



The information of both trip computers can be reset separately and therefore provides a facility for evaluating information over different time periods.

Select the required trip computer information and confirm.

The value for the selected function will be reset and recalculated.



To reset all information of a trip computer, select menu item **All values**.

After resetting, " - - - " is displayed with the trip computer information selected. The recalculated values are displayed after a brief delay.

### Interruption of power supply

If the power supply has been interrupted or if the battery voltage has dropped too low, the values stored in the trip computer will be lost.

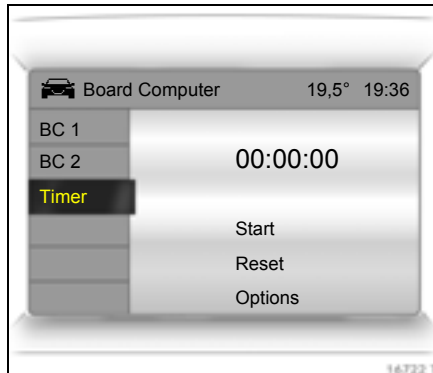

### Stop watch

Select menu item **Timer** from the **Board Computer** menu.

The **Timer** menu is displayed.

To start, select menu item **Start**. To stop, select menu item **Stop**.

To reset, select menu item **Reset**.

The stop watch information to be displayed can be selected via menu **Options** \*:

### Driving Time excl. Stops

Measurement of the time the vehicle is in motion. Stationary time is not included.

### Driving Time incl. Stops

Measurement of the time the vehicle is in motion. The time the vehicle is stationary with the key in the ignition switch is included.

### Travel Time

Measurement of the time from manual activation via **Start** to manual deactivation via **Reset**.

## Warning buzzers

**When starting the engine or whilst driving:**

- if seat belt \* is not fastened;
- upon operation of retractable steel roof or boot lid if the handbrake is not applied;
- upon operation of retractable steel roof if the roof lock is not released;
- upon operation of retractable steel roof if luggage compartment partition is not folded back;
- when starting off if retractable steel roof is not completely open or closed;
- when starting off if the boot lid is not completely closed;
- if the vehicle is equipped with Easytronic transmission \* and the driver's door is opened when the engine is running, a gear is engaged and the footbrake is not depressed.

**When the vehicle is parked and the driver's door is opened:**

- with the key in the ignition,
- with parking lamps or dipped beam on,
- If the turn signal stalk is engaged.



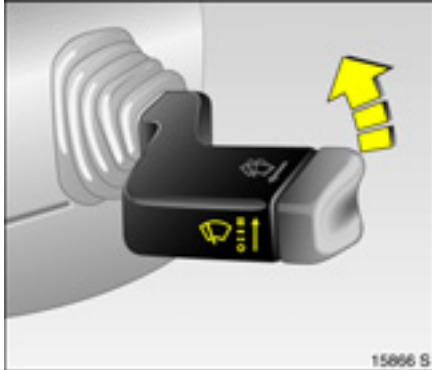

### Windscreen wipers

To activate, move stalk briefly up.

- ≡ = Fast
- = Slow
- = Adjustable timed interval wipe
- = Off

### Adjustable wiper interval \*

Setting wiper interval to a value between 2 and 15 seconds:

Stalk to timed interval wipe --, move stalk to position ○, wait until wiping frequency reaches the required interval time, stalk back to timed interval wipe --.

The interval time selected remains stored until it is next changed or until the ignition is turned off.

After turning on the ignition and setting the stalk to --, the interval is set to 7 seconds.

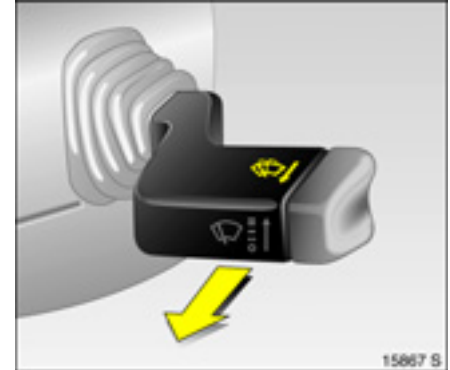

### Windscreen washer system

Pull stalk towards steering wheel. Washer fluid sprays onto the screen and the wipers are engaged for a few wipe movements.

# Lighting

Exterior lights .....	86
Main beam, headlamp flash .....	87
Turn signal lamps .....	87
Reversing lamps.....	87
Front fog lamps $\text{D}$ .....	87
Fog tail lamp $\text{D}$ .....	87
Hazard warning lamps .....	88
Headlamp range adjustment $\text{D}$ .....	88
Door-to-door lighting *.....	88
Instrument illumination $\text{D}$ .....	89
Information display illumination *.....	89
Courtesy lamp $\text{D}$ .....	89
Battery discharge protection *.....	89
Misted lamp covers .....	89
Headlamps when driving abroad.....	89



## Exterior lights

Turn light switch:

- 0** = Off
- $\text{D}$  = Parking lamps
- $\text{D}$  = Dipped beam or main beam

In positions  $\text{D}$  and  $\text{D}$ , the tail lamps and number plate lamps are also on.

If the ignition is switched off with the dipped beam or main beam on, the parking lamps illuminate \*.

**Versions with daytime running lamps \***  
With ignition on and light switch to **0**, the dipped beam is switched on without instrument panel lighting.

The daytime running lamps switch off when the ignition is switched off.

Follow the regulations of the country in which you are driving when using daytime running lamps and front fog lamps \*.

Driving abroad ⇨ 89.

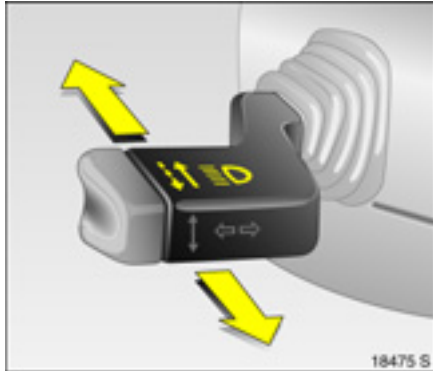

18475 S

### Main beam, headlamp flash

To switch from dipped to main beam, push stalk forwards

To switch to dipped beam, push stalk forwards again.

To activate the headlamp flash, pull stalk on steering wheel. Main beam is engaged for the duration of activation.

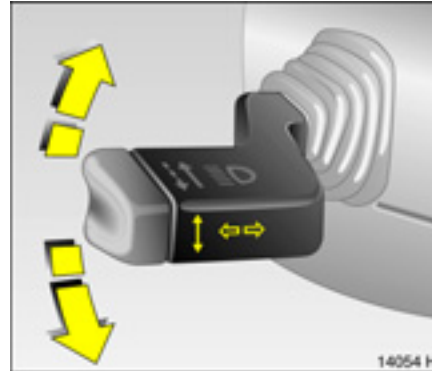

14054 H

### Turn signal lamps

Stalk up = Turn signal lamp right

Stalk down = Turn signal lamp left

If the stalk is moved past the resistance point, the turn signal lamp remains on. When the steering wheel moves back toward the straight-ahead position, the turn signal lamp is automatically deactivated.

Brief flash: push stalk to resistance point and release.

The turn signal lamps can be deactivated manually by returning the stalk to the centre position.



13720 S

### Front fog lamps $\text{D}$ \*

The front fog lamps can only be switched on when both the ignition and headlamps are on.

Operated with the  $\text{D}$  button.

### Fog tail lamp $\text{Q}$ ‡

The fog tail lamp can only be switched on both the ignition and dipped beam/parking lamps are on.

Operated with the  $\text{Q}$ ‡ button.

### Reversing lamps

The reversing lamps come on when the ignition is on and reverse gear is engaged.

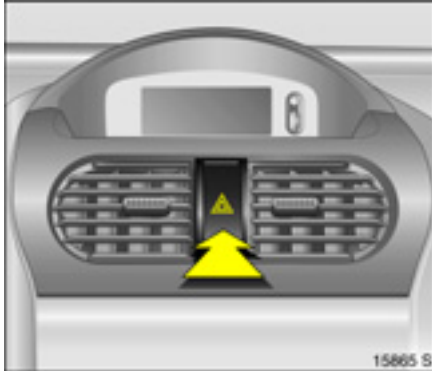

### Hazard warning lamps

Operated with the  button.

To aid location of the pushbutton, the red surface is illuminated when the ignition switched on. When the button is pressed, its control indicator flashes in time with the hazard warning lamps.



### Headlamp range adjustment

Adjust headlamp range to the vehicle load with dipped beam switched on:  
Turn adjuster wheel to required position.

#### Adjustment positions

- 0 = Driver's seat occupied
- 1 = Seats occupied
- 2 = Seats occupied and full load in luggage compartment

Position 3 is not used.

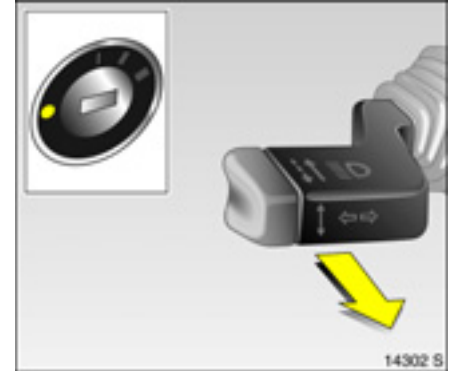

### Door-to-door lighting \*

Dipped beam illuminates for approx. 30 seconds after switching on and closing the driver's door.

#### To activate

1. Switch off ignition.
2. Remove ignition key.
3. Open driver's door.
4. Pull turn signal stalk toward steering wheel.
5. Close driver's door.

If the driver's door is left open, lighting will go out after two minutes.

The lighting goes out immediately if the ignition key is inserted or the turn signal stalk on the steering wheel is pulled again.



13722 B

### Instrument illumination ☼

Comes on with headlamps. Brightness can be adjusted with adjuster wheel.

### Information display illumination\*

Comes on when the ignition or Infotainment system is on. Brightness can be adjusted with adjuster wheel.



13721 B

### Courtesy lamp ☼

#### Automatic interior lamp

Activates automatically when a door is opened.

Goes off automatically after a delay\* when the doors are closed or immediately when the ignition is switched on\*.

#### Front courtesy lamp

Manual operation from inside with doors closed:

On = Press light switch ☼

Off = Press light switch ☼ again.

#### Luggage compartment\*

The luggage compartment lighting comes on when the luggage compartment is open.

### Battery discharge protection\*

Some consumers such as the interior lighting switch themselves off after approx. 30 minutes if the ignition is off in order to protect the battery charge.

### Misted lamp covers

The inside of the lamp covers may briefly mist up under unfavourable wet/cold weather conditions, during heavy rain or after the vehicle has been washed. The misting disappears of its own accord after a short time, but can be accelerated by switching on the headlamps.

### Headlamps when driving abroad

The asymmetrical dipped beam increases the field of vision on the passenger side of the lane.

This causes glare for oncoming traffic if the vehicle is driven in countries where traffic drives on the opposite side of the road.

To avoid dazzle, have a workshop convert the headlamps.

## Infotainment system

Radio reception *	90
Remote control on steering wheel *..	90
AUX input *	91
Infotainment system *	91
Mobile telephones and radio equipment (CB) *	91

### Radio reception \*

Radio reception may be disrupted by static, noise, distortion or loss of reception due to

- changes in distance from the transmitter,
- multi-path reception due to reflection and
- shadowing.



### Remote control on steering wheel \*

The functions of the Infotainment system \* and the information display can be operated with the buttons on the steering wheel.

Further information ⇨ 76, and the Infotainment system instructions.

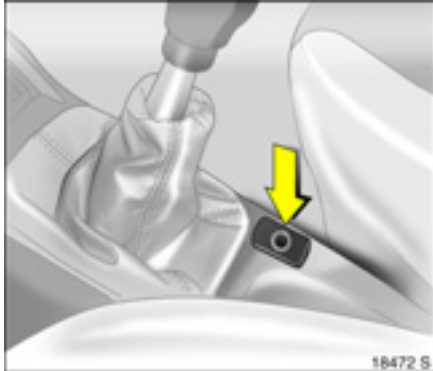

### AUX input \*

The AUX input is in the centre console between the seats.

An external audio source such as portable CD player can be connected using a 3.5 mm jack plug via the AUX input.

Always keep the AUX input clean and dry.

Further information in the Infotainment system instructions.

### Infotainment system \*

The Infotainment system is operated as described in the operating instructions.

### Mobile telephones and radio equipment (CB) \*

The Vauxhall installation instructions and the operating guidelines provided by the telephone manufacturer must be observed when fitting and operating a mobile telephone. Failure to do so could invalidate the vehicle's operating permit (EU Directive 95/54/EC).

Prerequisites for fault-free operation:

- professionally installed exterior antenna to obtain the maximum range possible,
- maximum transmission power 10 Watts,
- installation of the telephone in a suitable spot (see information ↗ 60).

Seek advice on predetermined installation points for the external antenna or equipment holder and ways of using devices with a transmission power exceeding 10 Watts.

We recommend using your Vauxhall Authorised Repairer who keeps consoles and various fitting kits in stock as accessories and will fit these professionally.

Use of a hands-free attachment without external antenna with mobile telephone standards GSM 900/1800/1900 and UMTS is only permitted if the maximum transmission power of the mobile telephone is 2 Watts for GSM 900 or 1 watt for the other types.

For reasons of safety, we recommend that you do not use the phone while driving. Even use of a hands-free set can be a distraction while driving. Be sure to observe any country-specific regulations.

<b>⚠ Warning</b>
Mobile phones which do not comply with the above standards, and radios, may only be used with antennae installed on the outside of the vehicle.

<b>Caution</b>
Mobile phones and radios can cause malfunctions of the vehicle electronics when operated inside the vehicle without an external antenna unless the instructions above are observed.

# Climate control

Heating and ventilation system, air conditioning system *	92
Air vents	92
Heating and ventilation system	94
Air conditioning system *	96
Air intake	99
Pollen filter	99
Regular operation	99
Service	99



## Heating and ventilation system, air conditioning system \*

Ventilation, heating and cooling \* are combined into one unit that is designed to provide comfort regardless of the season, weather or outside temperature.

When cooling \* is activated, the air is cooled and dried.

The heating unit heats the air as required in all operating modes depending on the position of the temperature rotary knob. The air supply can be adjusted to suit requirements by means of the fan.

The buttons for cooling \* and air recirculation are only found on versions with air conditioning system \*.

Air conditioning system \* → 96.

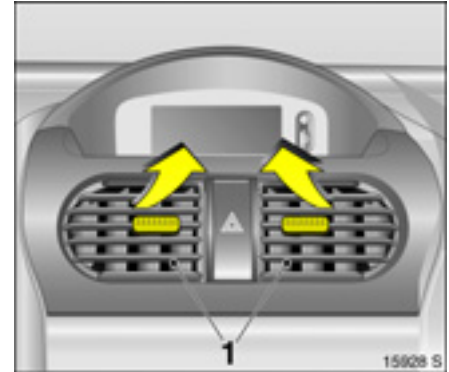

## Air vents

At least one air vent must be open while cooling \* (air conditioning compressor) is on, in order to prevent the evaporator from icing up due to lack of air movement.

The interior ventilation can be adjusted to a comfortable level by adjusting the temperature rotary knob.

To increase the air supply, turn the fan all the way up and set the air distribution rotary knob to or .



**Centre and side (1) air vents**

Direct the flow of air by tilting and swivelling the slats.

Temperature rotary knob in central area: that air that comes out of the centre air vents is cooler than the air coming out of the side air vents.

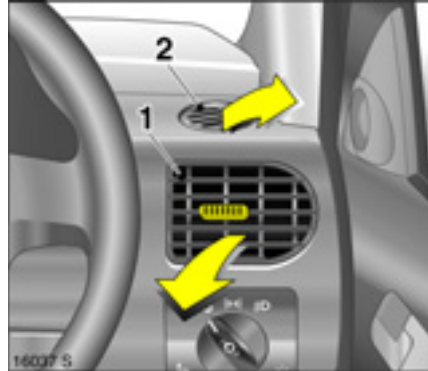

To close the air vents, push the slider towards the centre of the vehicle.

**Windscreen defroster nozzles (2)**

Air distribution rotary knob set to  or .

Air is directed onto the windscreen and door windows.

**Additional air vents**

Located beneath the windscreen and the side windows, and also in the footwell.

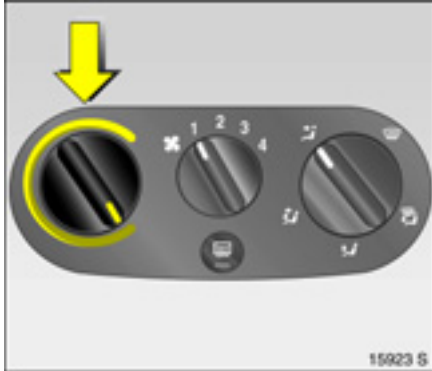

### Heating and ventilation system

#### Temperature

Adjustment with left-hand rotary knob.

Red area = Warm

Blue area = Cold

The amount of heat is dependent on the coolant temperature and is thus not fully attained until the engine is warm.

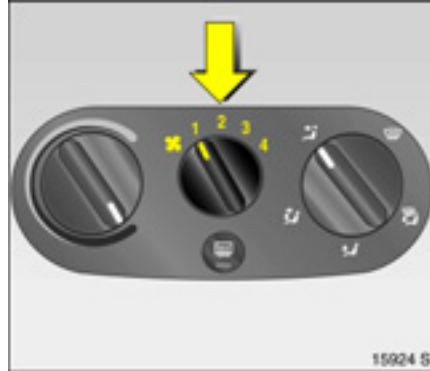

#### Air flow

Adjustment with central rotary knob.

✖ Off

1-4 Selected fan speed

The rate of air flow is determined by the fan. The fan should therefore also be switched on during a journey.

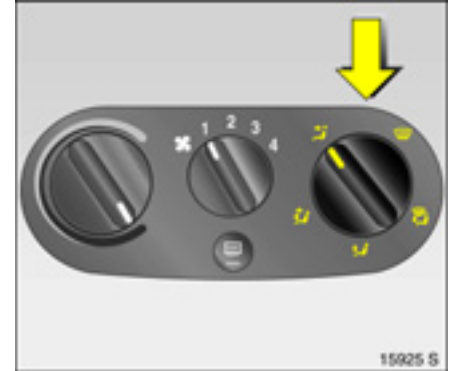

#### Air distribution

Adjustment with right-hand rotary knob.



 Towards windscreen and door windows

 Towards windscreen, door windows and footwell

 Towards footwell

 Towards head area and footwell

 Towards head area

Open the air vents when the rotary knob is set to  or .



### Ventilation

- Set the temperature to the required setting,
- switch on fan, adjust fan setting as required,
- for maximum ventilation in head area:  
Set air distribution rotary knob to 94 and open all air vents,
- for ventilation to footwell:  
Set air distribution rotary knob to 94,
- for simultaneous ventilation to the head area and the footwell:  
Set air distribution rotary knob to 94.

### Heating

For rapid warming of the passenger compartment:

- Turn the temperature rotary knob clockwise as far as it will go (warm),
- set the fan speed to 3,
- set air distribution rotary knob to required position, preferably position 94.

The comfort and general well-being of the vehicle occupants are to a large extent dependent on a suitable ventilation and heating setting.

To achieve a stratification of temperature with a pleasant "cool head and warm feet" effect, set the rotary air distribution rotary knob to 94, 94 or 94, set temperature rotary knob to any position (in centre range for best temperature stratification effect).



### Heating the footwell

- Set the temperature rotary knob to the right-hand zone.
- Switch on fan.
- Set air distribution rotary knob to 94.

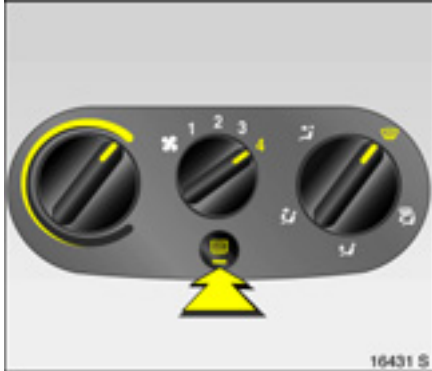



### Demisting and defrosting windows

#### **⚠ Warning**

Disregard of the instructions could lead to misting or icing of the windows and subsequent accidents due to impaired visibility.

In the event of misted or icy windows, such as in damp weather, from wet clothes or when outside temperatures are low:

- Turn the temperature rotary knob clockwise as far as it will go (warm).

- Set fan speed to 3 or 4,
- Set air distribution rotary knob to .
- Activate heated rear window ,
- Open side air vents as required and direct them towards door windows.
- For simultaneous footwell heating, set air distribution rotary knob to .

### **Air conditioning system \***

As a supplement to the heating and ventilation system, the air conditioning system cools and dehumidifies (dries) inflowing air.

If cooling or dehumidification is not required, switch off cooling in order to save fuel.

Cooling switches off automatically at low outside temperatures.



### Cooling ☀

Only operate with the engine and fan running. Activate and deactivate with the ☀ button.

When cooling (air conditioning compressor) is active, the air is cooled and dehumidified. If cooling or dehumidification is not required, switch off cooling in order to save fuel.

Cooling switches off automatically at low outside temperatures.

When cooling operates, condensation forms and drips from the underside of the vehicle.



### Air recirculation system 🚗

The air recirculation mode of the ventilation system is activated and deactivated by pressing the 🚗 button.

If fumes or unpleasant odours penetrate from outside: Temporarily switch on air recirculation system 🚗.

To increase the cooling power at high outside temperatures, temporarily switch on the air recirculation system.

### ⚠ Warning

The air recirculation system minimises the entry of outside air. The humidity increases, and the windows can mist up. The quality of the passenger compartment air deteriorates which may cause the vehicle occupants to feel drowsy.

Air distribution to 🚗: the air recirculation system is automatically switched off to speed up window demisting and prevent fogging.

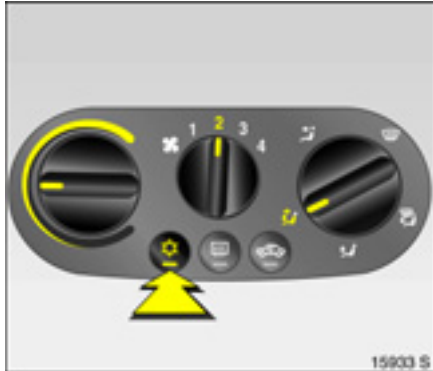

#### Comfort setting

- Set cooling ☀ as required.
- Air recirculation system 🔄 off.
- Set temperature rotary knob as required.
- Switch on fan at required speed
- Set air distribution rotary knob to 🚗 or 🚗.
- Open air vents as required.

Temperature rotary knob in centre of adjustment range: warmer air will flow into the footwell and cooler air into the upper zone, with warmer air coming from the side air vents and cooler air from the centre air vents.

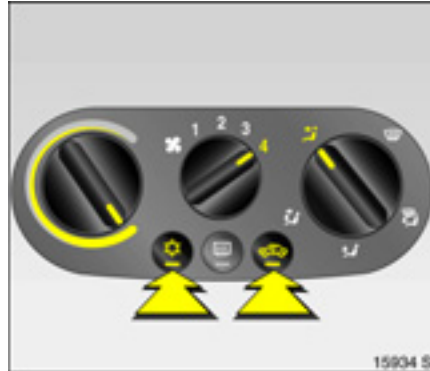

#### Maximum cooling

Briefly open windows to allow heated air to escape quickly.

- Cooling ☀ on.
- Air circulation system 🔄 on.
- Turn the temperature rotary knob anticlockwise as far as it will go (cold)
- Set fan speed to 4,
- Set air distribution rotary knob to 🚗.
- Open all air vents.









#### Demisting and defrosting windows

##### ⚠ Warning

Disregard of the instructions could lead to misting or icing of the windows and subsequent accidents due to impaired visibility.

In the event of misted or icy windows, such as in damp weather, from wet clothes or when outside temperatures are low:

- Cooling  on, the air conditioning compressor automatically switches off in low outdoor temperatures (ice formation),
- Turn the temperature rotary knob clockwise.
- Set fan speed to **3** or **4**.
- Air distribution rotary knob to , air recirculation system  automatically switches off,
  - or –
 if there is still moisture in the system after previous air conditioning operation, the windows may mist up. To prevent this, set air distribution to  before starting engine and set to  approx. 5 seconds after starting.
- Activate heated rear window .
- Open side air vents as required and direct them towards the side windows.

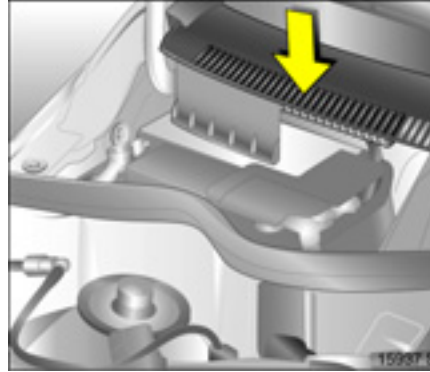

### Air intake

The air intakes in front of the windscreen on the far right and left sides of the engine compartment must be kept clear to allow air intake. Remove any leaves, dirt or snow.

### Pollen filter

The pollen filter cleans dust, soot, pollen and spores from the air entering from outside. The active carbon layer  eliminates most odours and noxious environmental gases from the air.

### Regular operation

For consistently good operation, cooling (air conditioning compressor)  must be switched on for several minutes once per month regardless of the weather and the time of year. Operation with the air conditioning compressor switched on is not possible at low outside temperatures.

### Service

For optimal cooling performance, we recommend that the climate control system be checked annually, starting 3 years after initial vehicle registration.

- Functionality and pressure test.
- Heating functionality.
- Leakage check.
- Check of drive belts.
- Cleaning of condenser and evaporator drainage.
- Performance check.

## Driving and Operation

Easytronic ❄️.....	100
Manual transmission .....	105
Driving hints .....	106
Saving fuel, protecting the environment .....	108
Fuel, refuelling .....	110
Catalytic converter, engine emissions	112
Drive control systems .....	114
Hydraulic brake system .....	119
Anti-lock Braking System (ABS (®)) ....	120
Handbrake .....	121
Brake assist .....	121
Wheels, tyres .....	121

### Easytronic ❄️

The Easytronic transmission ❄️ permits manual gearshifting (**Manual mode**) or automatic gearshifting (**Automatic mode**), both with automatic clutch control.



### Transmission display

Shows the mode or current gear.

If the Winter programme is activated, ❄️ is illuminated.





### Starting the engine

When starting the engine, activate the footbrake at the same time. The engine can only be started in position **N** and with the footbrake activated. The transmission display shows "N". If the footbrake is not activated, the control indicator  illuminates in the instrument cluster and "N" flashes in the transmission display; the engine cannot be started.

Also the vehicle cannot be started if all brake lamps have failed.

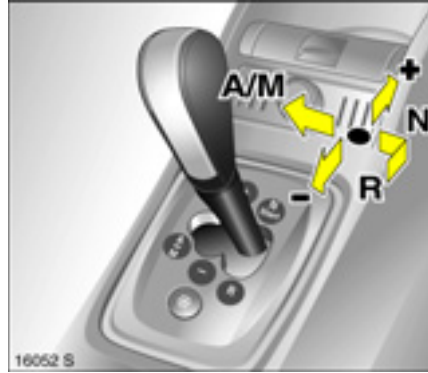

### Operating Easytronic with the selector lever

Always move the selector lever all the way to the stop. Note the gear or mode indicator in the transmission display.

### Selector lever in N

Neutral.

### Selector lever in ● (centre position)

Once the selector lever has been moved from **N** to position ● (centre position) with the footbrake depressed, the Easytronic is in automatic mode and first gear has been selected (second gear with Winter programme enabled). "A" appears in the transmission display.

When the footbrake is released the vehicle starts to "creep". If the footbrake is not depressed, "A" flashes. Start off by pressing the accelerator immediately or more selector lever back to **N** and repeat procedure with footbrake depressed.

Shifting to different gears takes place automatically in automatic mode, depending on the driving conditions.

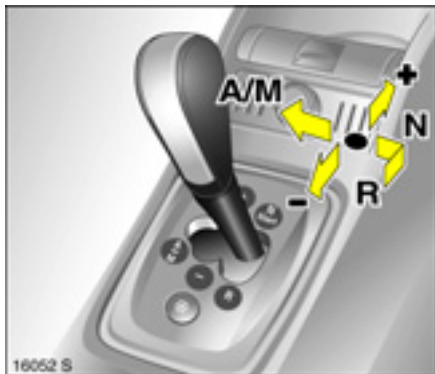

### Selector lever in A/M

Switch between Automatic and Manual mode.

In Manual mode, gears can be selected manually by moving the selector lever to + or -. The current gear is indicated in the transmission display.

If the engine speed is too low, Easytronic will automatically shift to a lower gear even in Manual mode. This prevents the engine from stalling.

### Selector lever in + or -

- + Shift to a higher gear.
- Shift to a lower gear.

If a higher gear is selected when the running speed is too low, or a lower gear when the speed is too high, no shift is effected. This prevents the engine from running at too low or too high revs.

Gears can be skipped by jogging the selector lever repeatedly at short intervals.

When the vehicle is in Automatic mode, the Easytronic shifts to Manual mode when the selector lever is set to position + or -. The transmission display shows the currently selected gear.

### Selector lever in R

Reverse gear. Engage only when vehicle is stationary.

Press button on selector lever, select R. The transmission display shows "R".

If R is selected when the vehicle is in motion, "R" flashes in the transmission display and no gear is engaged.

### Stopping the vehicle

In Automatic and Manual mode, when the vehicle has stopped, first gear (second gear with Winter programme engaged) is engaged automatically and the clutch is disengaged. In R, reverse gear remains engaged.

If a warning signal sounds when the driver's door is opened (footbrake not depressed), move the selector lever to N and apply the handbrake.

When stopping on gradients, apply the handbrake or depress the brake pedal. To prevent overheating of the clutch, do not increase engine speed to ensure smooth idling when in gear.

Switch off engine if stopping for a lengthy period, e.g. in traffic jams or at level crossings.

### Electronically controlled driving programmes in automatic mode

- The operating temperature programme increases the engine speed after a cold start to bring the catalytic converter to the required temperature quickly.
- Adaptive programmes automatically adapt gear selection to suit the driving conditions, such as if the vehicle has a high payload, or is being driven on inclines.

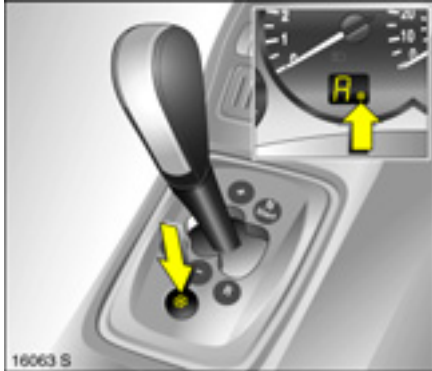

### Winter programme ❄️

In the event of difficulties starting-off on slippery roads, press button ❄️ ("A" and ❄️ appear in the transmission display). The Easytronic switches to Automatic mode and the vehicle sets-off in second gear.

The Winter programme is switched off by:

- pressing the ❄️ button again,
- turning off the ignition,
- switching to Manual mode,
- when clutch temperature is too high.

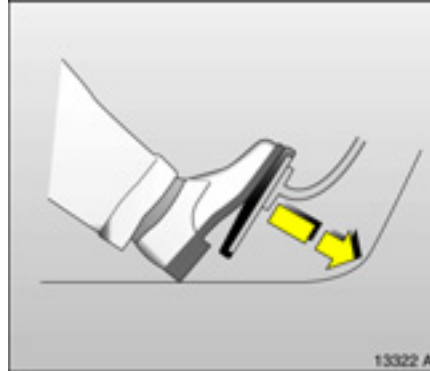

### Kickdown

If the accelerator pedal is pressed past the pressure point, the transmission shifts to a lower gear, depending on engine speed.

During kickdown, no manual gearshifting is possible.

When the engine speed approaches its upper limit, the transmission shifts to a higher gear during kickdown even in Manual mode.

Without kickdown this automatic shift is not effected in Manual mode.

### Engine braking

#### Automatic mode:

When driving downhill, the Easytronic does not shift into higher gears until a fairly high engine speed has been reached. When braking, it shifts down in good time.

#### Manual mode:

To utilise the engine braking effect, select a lower gear in good time when driving downhill.

### "Rocking" the vehicle

Only if it becomes necessary to rock the vehicle to free it from sand, mud, snow or a hole, move the selector lever between ● (centre position) and **R** in a repeat pattern. Do not race the engine and avoid sudden acceleration.



#### Manoeuvring the vehicle

To manoeuvre the vehicle back and forth during attempts to park or in garage entrances the creeping movement can be utilised by releasing the footbrake.

Never actuate accelerator and brake pedals simultaneously.

In order to prevent damage, the Easytronic disengages the "creep function" at extremely high automatic clutch temperatures.

#### Vehicle storage

Apply handbrake and remove ignition key. The most recently engaged gear (indicated in transmission display) remains engaged. With **N**, no gear is engaged.

When the ignition is switched off, the Easytronic no longer responds to movement of the selector lever.

If the ignition key is not removed, the battery may be discharged if the vehicle is then left to stand for a lengthy period of time.

If the handbrake has not been applied, the control indicator (D) flashes in the instrument cluster for a few seconds after the ignition is switched off.



#### Fault

To prevent damage to the Easytronic, the clutch is engaged automatically at high clutch temperatures.

Control indicator (D) illuminates in the event of a fault. Continued driving is possible. Manual mode can no longer be used for shifting.

If "F" also appears in the transmission display, it is not possible to continue driving.

Have the cause of the fault eliminated by a workshop. The self-diagnosis integrated into the system allows rapid fault identification.

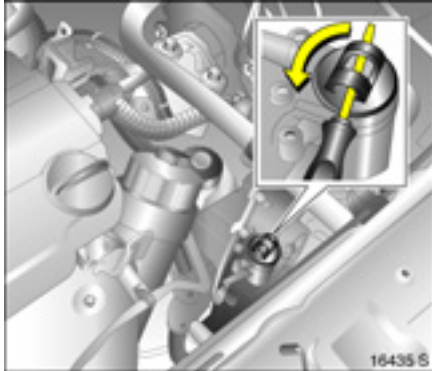

#### Interruption of power supply

The clutch is not disengaged if there is an interruption of the power supply when a gear is engaged. The vehicle cannot move.

If the battery is discharged, start the vehicle using jump leads ⇨ 127.

If the cause is not a discharged battery, contact a workshop. If the vehicle must be removed from moving traffic, disengage the clutch:

1. Apply handbrake and switch off ignition.
2. Open bonnet and engage support.

3. Clean transmission around the cap (see Fig. 16435 S) so that no dirt can get into the opening when the cap is removed.
4. Rotate cap to slacken and remove by lifting upwards – see Fig. 16435 S.
5. Turn the adjusting screw clockwise using a flat-head screwdriver (vehicle tools ⇨ 133) until clear resistance can be felt. The clutch has now been disengaged.

#### Caution

Do not turn beyond the resistance, since this can damage the Easytronic.

6. Fit cleaned cap again. The cap must be in full contact with the housing.

#### Caution

Towing the vehicle and starting the engine is not permitted when the clutch has been disengaged in this way, although the vehicle can be moved a short distance.

Contact a workshop immediately.

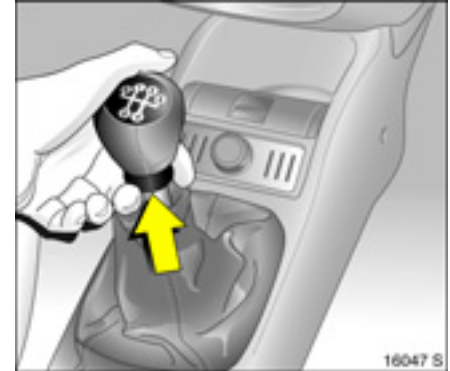

#### Manual transmission

To engage reverse, with the vehicle stationary, depress the clutch pedal, wait 3 seconds, then raise ring under gearshift lever and engage gear.

If the gear does not engage, set the lever in neutral, release the clutch pedal and depress again; then repeat gear selection.

Do not grind the clutch unnecessarily.

When operating, depress the clutch pedal completely. Do not use the pedal as a foot rest (increases clutch wear).

## Driving hints

### The first 600 miles (1000 km)

Drive your vehicle at various speeds. Do not use full throttle. Never allow the engine to labour at low revs.

Make good use of all gears. Depress the accelerator pedal a maximum of approx.  $\frac{3}{4}$  of the available pedal travel in all gears.

Do not drive faster than three quarters of maximum speed.

Do not brake unnecessarily hard for the first 125 miles (200 km).

During the first drive, smoke may develop because of wax and oil evaporating off the exhaust system. Park the vehicle in the open for a while after the first drive and avoid inhaling the fumes.

Fuel and engine oil consumption is higher than normal during the running-in period.

### Never coast with engine not running

Many units will not function in this situation (e.g. brake servo unit, electric power-assisted steering). Driving in this manner is a danger to yourself and others.

### Brake servo unit

When the engine is not running, the brake servo unit is no longer effective once the brake pedal has been depressed once or twice. Braking effect is not reduced, but significantly greater force is required for braking.

### Electric power-assisted steering

If the electric power-assisted steering fails when being towed with the engine switched off, the vehicle can still be steered, but considerably more force is required.

### Driving in mountainous terrain

The cooling fan is electrically operated. Its cooling power is therefore independent of the engine speed.

Since a considerable amount of heat is generated at high engine speeds and less at slower speeds, do not shift down when climbing hills whilst the vehicle is still coping with the gradient in the higher gear.

### Switching off the engine

When you switch off, fans in the engine compartment may continue running for a time to cool the engine.

If the engine temperature is very high, e.g. after driving in mountainous terrain: Allow the engine to idle for approx. 2 minutes, in order to prevent heat accumulation.

### Vehicles with turbocharged engine

After running at high engine speeds or high engine loads, operate the engine briefly at a low load or run in neutral for approx. 30 seconds before switching off, in order to protect the turbocharger.

### Save energy – more miles

Please observe the running-in hints on the previous page and the tips for saving energy on the following pages.

Good, technically correct and economical driving ensures maximum durability and performance for your vehicle.

**Overrun cut-off**

The fuel supply is automatically cut-off during overrun, e.g. when the vehicle is driven with a gear engaged but the accelerator pedal is not depressed. Overrun cut-off is deactivated if catalytic converter temperature is high.

**Vehicles with turbocharged engine**

Flow-generated noises may be audible if the accelerator is released quickly, on account of air flow in the turbocharger.

**Engine speed**

Drive in a low engine speed range for each gear as much as possible.

**Warming up**

Allow the engine to warm up while driving. Do not warm it up by letting it run at idling speed. Do not apply full throttle until the engine has reached operating temperature.

After a cold start, the Easytronic  does not shift to higher gears until the speed increases when it is in Automatic mode. This allows the catalytic converter to quickly reach the temperature that is required for optimum emission reduction.

**Correct gear selection**

Do not race your engine whilst in neutral or with a low gear selected. Driving too fast in individual gears as well as stop-and-go traffic increases engine wear and fuel consumption.

**Change down**

When decreasing speed, shift down into the next lowest gear. Do not slip the clutch with a high-revving engine. This is especially important when hill climbing.

**Cooling fan**

The cooling fan is controlled via a thermostic switch and therefore only runs if necessary.

**Pedals**

Do not place any objects in the footwell which could slip under the pedals and inhibit the pedal travel.

To ensure the pedal travel is uninhibited, there must be no mats in the area of the pedals.

**Battery care**

When driving slowly or when the vehicle is stationary, e.g. in slow urban traffic, stop-and-go traffic or traffic jams, turn off all unnecessary electrical loads where possible (e.g. heated rear window, heated seats).

Depress clutch pedal when starting, in order to relieve the strain on the starter and the battery.

## Saving fuel, protecting the environment

### Trend-setting technology

In the development and manufacture of your vehicle, environment-friendly and in the main recyclable materials were used. The production methods used to make your vehicle are likewise environmentally compatible.

Recycling of production wastes keeps the circulation of material closed. Reduction of energy and water requirements also helps to conserve natural resources.

A highly advanced design means that your vehicle can be easily disassembled at the end of its working life, and the individual materials separated for subsequent re-use.

Materials such as asbestos and cadmium are not used. The refrigerant in the air conditioning system \* is CFC-free.

New painting techniques employ water as a solvent.

### End-of-Life Vehicle recovery

For detailed information on Vauxhall's ongoing commitment to achieving an environmentally sustainable future, including; design for recycling, take back of End-of-Life Vehicle (ELVs) and the recycling of ELVs, view [www.Vauxhall.co.uk/recycling](http://www.Vauxhall.co.uk/recycling) for details.

### Energy and environment-conscious driving

■ High noise levels and exhaust emissions are often a result of driving without due attention to saving energy and protecting the environment.

■ You should therefore drive with energy in mind "more miles – less fuel".

Reduce the noise level and exhaust emissions by adopting an environment-conscious driving style. This is extremely worthwhile and improves the quality of life.

Fuel consumption depends to a great extent on your own personal driving style. The following hints are intended to help you consume fuel at a rate that is as close as possible to the specified levels ⇨ 172.

Check your vehicle's fuel consumption every time you refuel. This facilitates early detection of any irregularities causing increased fuel consumption.

### Warming up

■ Full throttle and warming up at idle speed increase wear, fuel consumption, exhaust emission, the amount of pollutant in the exhaust and the amount of noise.

■ Drive off immediately after starting. Warm up the engine by running it at moderate engine speeds.

### Uniform speed

■ Hectic driving significantly increases fuel consumption, the exhaust emissions, the proportion of pollutant in the exhaust gas and the noise level.

■ Do not accelerate and brake unnecessarily. Drive at uniform speed, watching the road.

Avoid frequent starting off and stopping e.g. at traffic lights, in short distance traffic and in queues of traffic by means of clever planning. Select roads with good traffic flow.

### Idling

■ The engine also consumes fuel when idling.

■ If you have to wait for more than one minute, it is worthwhile switching off the engine. Five minutes of idling corresponds to approx. 0.6 miles (1 km) of driving.



**Overrun**

- The fuel supply is automatically cut-off during overrun, e.g. when the vehicle is being driven down long gradients or when braking ⇨ 109.
- To enable the overrun cut-off to come into action and save fuel, do not accelerate or depress clutch pedal during overrun.

**Correct gear selection**

- High revs increase engine wear and fuel consumption.
- Do not race your engine. Avoid driving at high engine speeds.

Making use of the tachometer helps to save fuel. Drive in a low engine speed range for each gear as much as possible with uniform engine speeds. Drive as often as possible in top gear, select the next higher gear as soon as possible, and only change down when the engine is no longer running perfectly smoothly.

**High speed**

- The higher the speed, the higher the consumption and the noise level. At top speed, you consume a great deal of fuel and produce excessive noise and exhaust emissions.
- Slightly releasing the accelerator pedal results in distinct fuel savings with no major loss of speed.

Drive at no more than approx. three quarters of maximum speed and you will use up to 50% less fuel, without losing a great deal of time.

**Tyre pressure**

- Inadequate tyre pressure, leading to higher road resistance, costs money in two ways: for more fuel and increased tyre wear.
- Regular checks (every 14 days) pay off.

**Electrical loads**

- The power consumption of electrical equipment increases fuel consumption.
- Switch off all auxiliary electrical loads (e.g. air conditioning ✱, heated rear window) when not needed.

**Repair and maintenance**

- Improper repairs or adjustment and maintenance work can increase fuel consumption. Do not carry out work on the engine yourself.

You may, out of ignorance, infringe environmental laws by not disposing of materials properly.

Appropriate parts might not be recycled.

Contact with some of the materials involved may pose a health hazard.

- We recommend that repair and maintenance be entrusted to your Vauxhall Authorised Repairer.

**Extreme driving conditions**

- Going up steep slopes, cornering, driving on poor roads and winter driving all increase fuel consumption.

Fuel consumption increases dramatically in urban traffic and at winter temperatures, especially on short trips when the engine operating temperature is not reached.

- Follow the hints given above to keep consumption to a minimum under such conditions.

### Fuel, refuelling

#### Fuel consumption

Fuel consumption is determined under specific driving conditions ⇨ 172.

Special equipment increases the weight of the vehicle. As a result, they can increase fuel consumption and reduce the specified maximum speed.

There is increased friction between engine and transmission parts during the first 600 miles (1000 kilometres). This increases fuel consumption.

#### Fuel for petrol engines

Only use unleaded fuel that complies with DIN EN 228.

Fuels with ethanol content greater than 5% may only be used if the vehicle has been specifically developed and approved for these fuels.

Use fuel with the recommended octane rating (value in bold ⇨ 170). Use of fuel with too low an octane rating can reduce engine power and torque and slightly increases fuel consumption.

Caution
Use of fuel with too low an octane rating could lead to uncontrolled combustion and engine damage.

#### Fuel for diesel engines

Only use diesel fuel that complies with DIN EN 590. The fuel must have low sulphur content (maximum 50 ppm).

Since January 2004, some oil companies have mixed their diesel fuel with upto 5% Bio fuel (FAME = Fatty Acid Methyl Esters) like RME (Rape-Oil Methyl Ester). This is in accordance with the current DIN EN 590 and does not harm the fuel/injection system. The characteristics of a diesel fuel mixed up with 5% Bio fuel (FAME) do not differ from conventional diesel fuel and do not influence the vehicle's driveability.

**Important:** Diesel fuel mixed with 5% FAME according to DIN EN 590 must not be confused with 100% Bio Diesel, which is not to be used in Vauxhall engines.

The flow and filterability of diesel fuel are temperature-dependent.

Diesel fuels with improved low temperature properties are therefore available on the market during the winter months. Make sure that you fill the tank with winter fuel before the start of the cold weather season.

Additives can be used with diesel fuels with winter properties that are guaranteed by the manufacturer and when using diesel fuel filters that are heated depending on the outside temperature.

Diesel fuels must not be diluted with fuels that are intended for petrol engines.

**Fuel filler cap**

Only a Vauxhall genuine fuel filler cap provides full functionality. Diesel-engined vehicles have special fuel filler caps.

**Refuelling**

**⚠ Warning**

Before refuelling, switch off engine and external heaters with combustion chambers. Switch mobile phones off. Follow the operating and safety instructions of the filling station when refuelling.

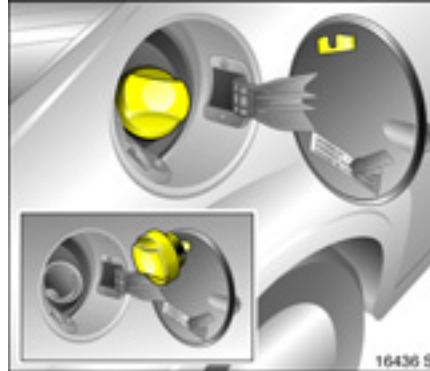

**⚠ Warning**

Fuel is flammable and explosive. No smoking. No naked flames or sparks. If you can smell fuel in your vehicle, have the cause of this rectified immediately by a workshop.

Fuel filler neck at right rear side of vehicle. The tank flap is unlocked with the doors  23.

Open the tank flap.

Unscrew fuel filler cap to open and suspend from tank flap.

The fuel tank has a limiting system which prevents overfilling of the tank.

Correct filling depends to a large extent on proper operation of the fuel dispensing pump:

1. Fully insert the filler nozzle and switch it on.
2. After the automatic cut-off the nominal capacity of the fuel tank can be obtained by topping up with two doses of fuel. Make sure the nozzle is fully inserted.

To close, position the fuel filler cap and rotate past the resistance until the cap audibly clicks over the retainer.

Close tank flap.

**Caution**

Wipe off any overflowing fuel immediately.

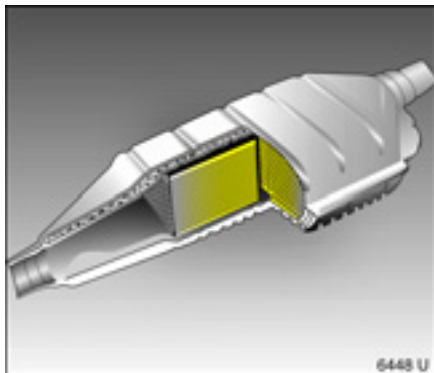

## Catalytic converter, engine emissions

### Catalytic converter

The catalytic converter reduces the amount of harmful substances in the exhaust gas, such as carbon monoxide (CO), hydrocarbons (CH) and nitrous oxide (NO<sub>x</sub>).

Fuel grades other than those listed on page 110 (e.g. LRP = Lead Replacement Petrol or leaded fuel) could damage the catalytic converter or electronic components.

### Caution

Damage to the catalytic converter or the vehicle may result if the following points are not observed.

- In the event of misfiring, uneven engine running, a clear reduction in engine performance or other unusual problems, have the cause of the fault rectified by a workshop as soon as possible. In an emergency, driving can be continued for a short period, keeping vehicle speed and engine speed low.

This does not apply when the Electronic Stability Programme (ESP®<sup>Plus</sup>\*) kicks in ⇨ 114.

- If unburned fuel enters the catalytic converter of a petrol engine, this may result in overheating and irreparable damage to the catalytic converter.

You should therefore avoid unnecessarily long use of the starter when starting off, running the tank dry and starting the engine by pushing or towing.



### Controlling exhaust emission

Some of the damaging substances in the exhaust such as carbon monoxide (CO), hydrocarbons (HC) and nitrous oxides (NO<sub>x</sub>) are reduced to a minimum by making structural changes – mainly in the injection system and the ignition system in conjunction with the catalytic converter.



Control indicator  for exhaust

Illuminates when the ignition is switched on and during the start attempt. Goes off shortly after the engine starts running.

Illuminated with the engine running indicates a fault in the exhaust gas cleaning system. The permitted emissions may be exceeded. Contact a workshop immediately.

Flashing with the engine running indicates a fault which could lead to catalytic converter damage. You may continue driving without damage if you slow down until flashing stops and the control indicator comes on. Contact a workshop immediately.



Control indicator  for engine electronics

Comes on for a few seconds after the ignition is turned on.

If it illuminates when the engine is running, there is a fault in engine or transmission electronics. The electronic system switches to an emergency running programme. Fuel consumption may be increased and the driveability of the vehicle may be impaired.

In some cases, faults can be eliminated by switching off the engine and restarting. If the control indicator comes on again when the engine is running, contact a workshop to eliminate the cause of the fault.

If it illuminates briefly, but does not recur, it is of no significance.

Illumination of control indicator  can indicate water in the diesel fuel filter. Check fuel filter for possible water residue  $\rightarrow$  162.

If it flashes after the ignition is switched on, there is a fault in the immobiliser system.

The engine cannot be started  $\rightarrow$  21.

Engine exhaust

**⚠ Warning**

Engine exhaust gases contain poisonous carbon monoxide, which is colourless and odourless and could be fatal if inhaled.

If exhaust gases penetrate the vehicle interior, open a window and contact a workshop.

**Maintenance**

Have all maintenance work carried out at the intervals specified. We recommend that you entrust this work to your Vauxhall Authorised Repairer, who has proper equipment and trained personnel available. Electronic testing systems permit rapid diagnosis and remedy of faults. This way you can be certain that all components of the vehicle's electrical, injection and ignition systems operate correctly, that your vehicle has a low level of pollutant emission and that the catalytic converter system will have a long service life.

You are thereby making an important contribution towards keeping the air clean and compliance with emissions legislation.

Checking and adjustment of the fuel-injection and ignition systems is included in service inspections. For this reason, you should have all maintenance work carried out at the intervals specified in the chapter "Service and Maintenance" ⇨ 152.

**Drive control systems**

**Electronic Stability Programme (ESP®<sup>Plus</sup>)\***

ESP®<sup>Plus</sup> improves driving stability when necessary in any driving situation, regardless of the type of road surface or tyre grip. It also prevents the drive wheels from spinning.

As soon as the vehicle starts to swerve (understeer/oversteer), engine output is reduced and the wheels are braked individually. This considerably improves the driving stability of the vehicle on slippery road surfaces.

ESP®Plus is ready for operation as soon as the ignition is switched on and control indicator  goes out.

When ESP®Plus comes into action,  flashes.

The vehicle is now in a critical situation; ESP®Plus allows you to keep control of the vehicle and reminds you to match your speed to the road conditions.

#### **Warning**

Do not let this special safety feature tempt you into taking risks when driving. Traffic safety can only be achieved by adopting a responsible driving style. Adapt speed to the road conditions.



#### Control indicator

The control indicator illuminates for a few seconds after the ignition is turned on. The system is ready for operation when the control indicator goes out.

#### Flashing during driving:

This shows the system has come into action. The engine output may be reduced (the sound of the engine changes) and the vehicle may be braked automatically to a small degree.

Illuminates while driving:

Fault in the system. Driving can be continued. Poor road surface conditions may however still cause vehicle stability to be impaired.

Have the cause of the fault eliminated by a workshop. The self-diagnosis integrated into the system allows rapid fault identification.

Control indicator  may illuminate when the temporary spare wheel is in use. The system is then deactivated.

Illuminates after interruption of power supply e.g. after disconnecting battery. After a power supply interruption the steering angle sensor must be calibrated to make the system operational:

- Automatic calibration by driving in straight line at constant slow speed, i.e. 12 to 25 mph (20 to 40 km/h), on a level, dry road,
- Manual calibration by turning steering wheel from limit position to limit position.

If the control indicator does not go off after successful calibration, observe notes in previous column.

### Cruise control ✱

Cruise control can store and maintain speeds of approx. 20 to 125 mph (30 to 200 km/h). Deviation from the stored speed is possible on uphill or downhill inclines.

For safety reasons, the cruise control cannot be activated until the footbrake has been depressed once.

The cruise control is operated with the buttons **I**, **R** and **O** on the turn signal stalk.

Do not use the cruise control if it is not advisable to maintain a constant speed (e.g. in situations presenting a danger to yourself and other road users, in heavy traffic or on winding, slippery or greasy roads).

With Easytronic ✱, only use cruise control when in automatic mode.

#### **⚠ Warning**

When the cruise control is active, reaction times may be increased due to the different position of the feet.



#### To activate

Tap button **I**: the current speed is stored and maintained. The accelerator pedal can be released.

Vehicle speed can be increased by depressing the accelerator pedal. When the accelerator pedal is released, the previously stored speed is resumed.



Increase

With cruise control active, hold down button **I** or briefly press it repeatedly: speed is increased continuously or in steps of 1.2 mph (2 km/h).

The current speed is stored and saved after button **I** has been released.

Decelerate

With cruise control active, hold down button **R** or briefly press it repeatedly: speed is reduced continuously or in steps of 1.2 mph (2 km/h).

The current speed is stored and saved after button **R** has been released.

To deactivate

Briefly press the **O** button: cruise control is deactivated.

Automatic deactivation if:

- the vehicle's speed drops below approx. 20 mph (30 km/h), or
- the brake pedal is depressed,
- the clutch pedal is depressed ✱,
- selector lever with Easytronic ✱ is in **N**.

Stored speed

The speed is saved until the ignition is switched off.

To resume the saved speed, briefly press button **R** at a speed above 20 mph (30 km/h).

### Ultrasonic parking sensors \*

Parking distance sensors make reverse parking easier by measuring the distance between the rear of the vehicle and obstacles behind it. It is the driver, however, who maintains full responsibility for parking.

The system records the distance using four sensors in the rear bumper.

#### To activate

The parking distance sensors are activated automatically when the ignition is switched on and reverse gear is engaged.

Operational readiness is indicated by a brief tone.

If the vehicle approaches an obstacle, a series of acoustic signals sound. The interval between the signals becomes shorter as the vehicle gets closer to the obstacle. When the distance is less than 30 cm, the signal is continuous.



#### **⚠ Warning**

Under certain circumstances, various reflective surfaces on objects or clothing as well as external noise sources may cause the system to fail to detect obstacles.

#### To deactivate

The system deactivates automatically when reverse gear is disengaged.

#### Fault

In the event of system faults, a permanent tone sounds at a distance of 1 metre from the obstacle. Have the cause of the fault eliminated by a workshop.

In order to avoid operational problems or erroneous information, the sensors must be undamaged and free of soiling, snow and ice.

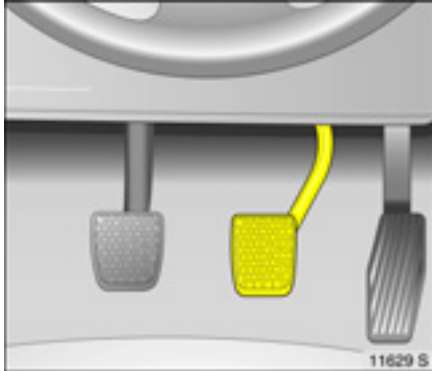

### Hydraulic brake system

The brake system comprises two independent brake circuits.

If one brake circuit faults, the vehicle can still be braked with the other brake circuit. However the braking effect will occur at a lower pedal position and considerably more force is required. The braking distance will be extended. Contact a workshop before continuing to drive.

To ensure the full pedal travel can be utilised, especially in case of a fault in one of the brake circuits, there must be no mats in the vicinity of the pedals ⇨ 107.

When the engine is not running, the assistance of the brake servo unit disappears once the brake pedal has been depressed once or twice. Braking effect is not reduced, but braking requires significantly greater force. This is especially important to bear in mind when towing.

The brake fluid level should be checked regularly. If the brake fluid level is too low and the handbrake is not applied, control indicator Ⓢ illuminates in the instrument cluster ⇨ 70.



### Brake system control indicator Ⓢ

The control indicator illuminates after the ignition is turned on, when the handbrake is applied or if the brake or clutch fluid level is too low. Brake fluid ⇨ 164.

#### ⚠ Warning

If the control indicator comes on when the handbrake is released, stop driving immediately. Contact a workshop.

For vehicles with Easytronic ✱, the control indicator flashes for a few seconds when the ignition is turned off if the handbrake is not applied.

### Anti-lock Braking System (ABS) <sup>(ABS)</sup>

ABS prevents the wheels from locking.

ABS starts to regulate brake pressure as soon as a wheel shows a tendency to lock. The vehicle remains steerable, even during hard braking.

ABS control is made apparent through a pulse in the brake pedal and the noise of the regulation process.

For optimum braking, keep the brake pedal fully depressed throughout the braking process, despite the fact that the pedal is pulsating. Do not reduce the pressure on the pedal.



#### Control indicator <sup>(ABS)</sup> for ABS

It comes on for a few seconds after the ignition is turned on. The system is ready for operation when the control indicator goes out.

If the control indicator does not go out after a few seconds, or if it illuminates while driving, there is a fault in the ABS. The brake system remains operational without ABS regulation.

#### Self-check

When the engine is started and the vehicle starts off, the system performs a self-check, which may be audible.

#### Fault

##### Warning

If there is a fault in the ABS, the wheels may be liable to lock due to braking that is heavier than normal. The advantages of ABS are no longer available. During hard braking, the vehicle can no longer be steered and may swerve.

Have the cause of the fault eliminated by a workshop. The self-diagnosis integrated into the system allows rapid fault identification.

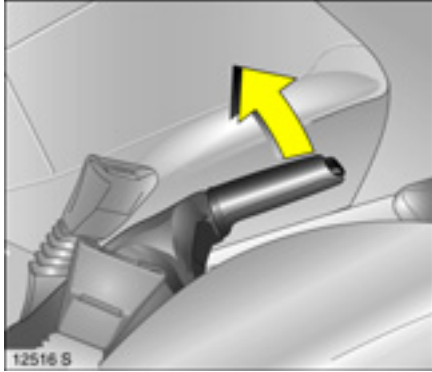

### Handbrake

Always apply handbrake firmly without operating the release button, and apply as firmly as possible on a downhill or uphill slope.

To release the handbrake, pull the lever up slightly, press the release button and fully lower the lever.

To reduce the operating forces of the handbrake, depress the footbrake at the same time.

### Brake assist

If the brake pedal is operated with a fast, powerful push, the vehicle is automatically braked at full braking power in order to achieve the shortest possible braking distance when full-on braking occurs (brake assist).

Maintain steady pressure on the brake pedal for as long as full-on braking is to continue. When the brake pedal is released, the maximum brake force amplification is taken away.

### Wheels, tyres

Suitable tyres and restrictions ⇨ 176.

Tyres fitted in the factory are adapted to the chassis and provide optimum driving comfort and safety.

#### Changing tyre/wheel type

If tyres of a different size than those fitted at the factory are used, it may be necessary to reprogramme the electronic speedometer and make other vehicle modifications.

#### **⚠ Warning**

Use of unsuitable tyres or wheels may lead to accidents and render the vehicle unroadworthy.

### Fitting new tyres

Fit tyres in pairs or in sets, which is even better. Ensure that tyres on one axle are:

- the same size,
- the same design,
- the same make,
- and have the same tread pattern.

Fit directional tyres such that they roll in the direction of travel. The rolling direction is indicated by a symbol (e.g. an arrow) on the sidewall.

Tyres fitted opposing the rolling direction (such as when changing a tyre) should be refitted as soon as possible. This is the only way to benefit fully from the design properties of the tyre.

When disposing of tyres, follow the legal requirements.



### Tyre pressure

Check tyre pressures at least every 14 days and prior to any long journey; the tyres should be checked when cold. Don't forget to check the spare ✱.

Tyre pressures ⇄ 176.

The tyre pressure data is for cold tyres. It applies to both summer and winter tyres.

Do not reduce tyre pressure when the tyres are warm. Otherwise the pressure may drop below the permissible minimum when the tyres cool down.

Screw on the valve cap after checking pressure.

Incorrect tyre pressures will impair safety, vehicle handling, comfort and fuel economy and will increase tyre wear.

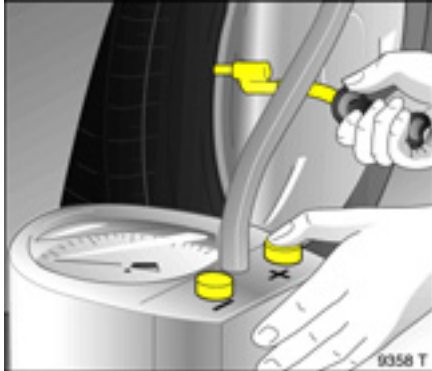

### ⚠ Warning

If the pressure is too low, this can result in considerable tyre warm-up and internal damage, leading to tread separation and even to tyre blow-out at high speeds.

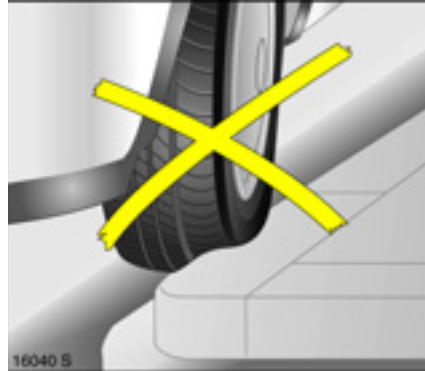

### Tyre condition, wheel condition

Drive over edges slowly and at right angles if possible. Driving over sharp edges can cause tyre and wheel damage. Do not trap tyres on the kerb when parking.

Regularly check the wheels for damage. Seek the assistance of a workshop in the event of damage or unusual wear.



### Tread depth

Check tread depth regularly.

For reasons of safety, tyres should be replaced when their tread depth has worn down to 2 to 3 mm (winter tyres: 4 mm).

The legally permissible minimum tread depth (1.6 mm) has been reached when the tread has worn down as far as one of the tread wear indicators (TWI<sup>1)</sup>). A number of tread wear indicators are spaced at equal intervals around the tyre within the tread. Their position is indicated by markings on the tyre sidewall.

<sup>1)</sup> TWI = Tread Wear Indicator.

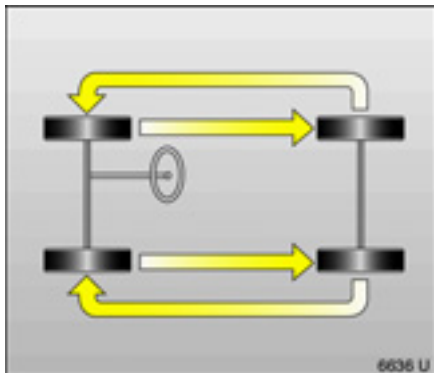

If tread wear is greater in the front than in the rear, switch the front and rear tyres.

Correct the tyre pressures.

### General information

- The risk of aquaplaning is greater if the tyres are worn.
- Tyres age, even if they are used little or not at all. We recommend tyre replacement at the latest every 6 years.
- Never fit used tyres the previous history and use of which you do not know.

### Tyre designations

Meanings:

e.g. **185/55 R 15 84 H**

- 185** = Tyre width in mm
- 55** = Cross-section ratio (tyre height to width in %)
- R** = Belt type: Radial
- 15** = Wheel diameter in inches
- 82** = Load index  
e.g. 82 corresponds to 475 kg
- H** = Speed code letter

Speed code letters:

- Q** = up to 100 mph (160 km/h)
- S** = up to 112 mph (180 km/h)
- T** = up to 118 mph (190 km/h)
- H** = up to 130 mph (210 km/h)
- V** = up to 150 mph (240 km/h)
- W** = up to 168 mph (270 km/h)

### Winter tyres ❄

Notes on fitting new tyres ⇨ 122.

Restrictions ⇨ 176.

Winter tyres (M + S tyres) improve driving safety at temperatures below 7 °C and should therefore be fitted on all wheels.

The design of summer tyres means they have limited qualities for winter driving.

In accordance with country-specific regulations, affix the speed sticker ❄ in the driver's field of view.

If you use the spare wheel when it is fitted with a summer tyre, the vehicle's driveability may be affected, especially on slippery road surfaces. Obtain a replacement for the faulty tyre as soon as possible, and have the wheel balanced and fitted to the vehicle.



**Wheel trims ✱**

Use wheel trims and tyres that are approved by Vauxhall for the vehicle in question and therefore meet all the requirements pertaining to the respective wheel/tyre combination.

If the wheel trims and tyres used are not Vauxhall-approved, the tyres must not have a beaded edge.

Wheel trims must not impair brake cooling.

Remove the wheel trims if fitting tyre chains ✱.

**⚠ Warning**

Use of unsuitable tyres or wheel trims could lead to sudden loss of air and thereby accidents.



**Tyre chains ✱**

Restrictions and further notes ⇨ 176.

Tyre chains are only permitted on the drive wheels (front axle). They must be fitted to the tyres symmetrically in order to achieve a concentric fit.

Always use fine mesh chains that add no more than 10 mm to the tyre tread and the inboard sides (including chain lock).

Remove the wheel trims if using tyre chains.

Tyre chains may only be used at speeds up to 30 mph (50 km/h). They must only be used for brief periods on roads that are free of snow.

**⚠ Warning**

Damage may lead to tyre blowout.

Tyre chains must not be used on the temporary spare wheel. If you need to use tyre chains after suffering a flat front tyre, fit the temporary spare on the rear axle and transfer one of the rear wheels to the front axle.

## Self-help, Vehicle Care

Diesel fuel system, bleeding .....	126
Bonnet .....	126
Starting the engine with jump leads *	127
Towing your own vehicle.....	129
Warning triangle ▲ * and First-aid kit ☹ *.....	130
Spare wheel *.....	131
Jack 🛠 * and vehicle tools *.....	133
Changing wheels .....	133
Tyre repair aerosol * .....	137
Electrical system .....	138
Fuses and the most important circuits they protect .....	140
Bulb replacement .....	144
Halogen headlamp system dipped and main beam.....	144
Turn signal lamps .....	146
Front fog lamps * .....	146
Tail lamps.....	147
Number plate lamp.....	148
Courtesy lamp.....	149
Vehicle care.....	150

### Diesel fuel system, bleeding

Never let the tank run dry! If control indicator 🛑 illuminates, refuel as soon as possible. Refuel immediately if it flashes.

If the tank is allowed to run dry, the diesel fuel system must be bled. Switch on the ignition three times for approx. 15 seconds at a time. Then start the engine for a maximum of 40 seconds. Repeat this process after no less than 5 seconds. If the engine fails to start, seek the assistance of a workshop.

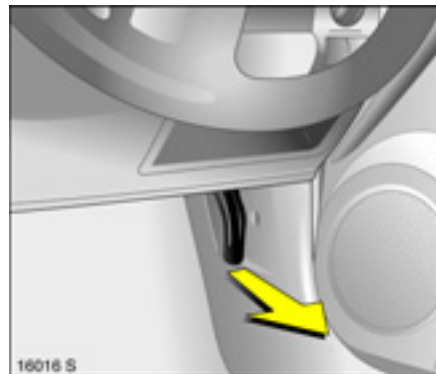

### Bonnet

Pull the release lever located on the driver's side below the instrument panel, and press back to its original position.

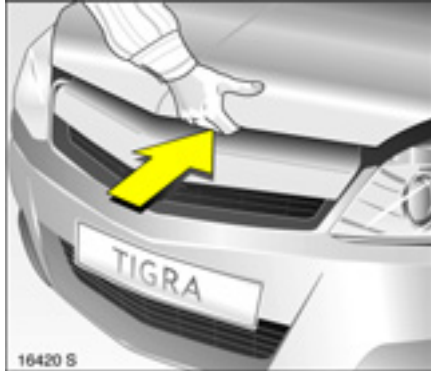

Pull the safety catch upwards and open the bonnet.

Any dirt or snow on the bonnet can slide down towards the windscreen when the bonnet is opened and block the air intake ⚠ 99.

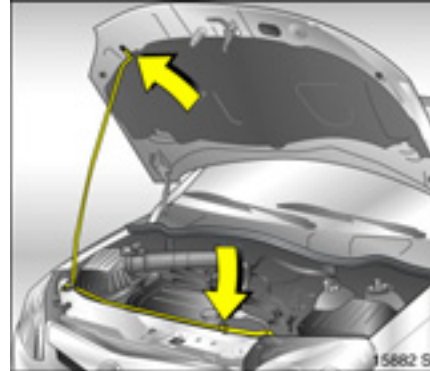

Secure the bonnet support. Before closing the bonnet, press the support into the holder.

Lower the bonnet and allow it to drop into the catch. Check that the bonnet is engaged.

### Starting the engine with jump leads\*

Do not start with a quick charger or by pushing or towing.

A vehicle with a discharged battery can be started using jump leads and the battery of another vehicle.

Attempts to start the vehicle should be made at intervals of one minute and should not last longer than 15 seconds.

#### **⚠ Warning**

Be extremely careful when starting with jump leads. Any deviation from the following instructions can lead to injuries or damage caused by battery explosion or damage to the electrical systems of both vehicles.

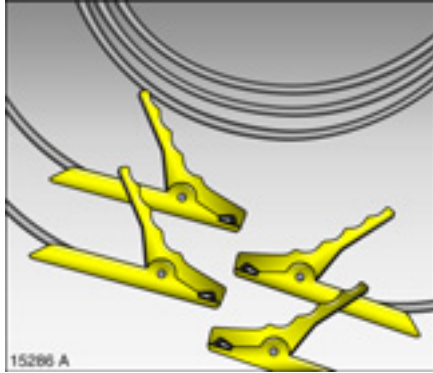

- Never expose the battery to naked flames or sparks.
- A discharged battery can freeze even at temperatures of 0 °C. Thaw frozen batteries before connecting jump leads.
- Do not allow battery fluid to come into contact with eyes, skin, fabrics or painted surfaces. The fluid contains sulphuric acid which can cause injuries and damage in the event of direct contact.
- Wear eye protection and protective clothing when handling a battery.

- Use a booster battery with the same voltage (12 volts). Its capacity (Ah) must not be much less than that of the discharged battery.
- Use jump leads with insulated terminals and a cross section of at least 16 mm<sup>2</sup> (25 mm<sup>2</sup> for diesel engines).
- Do not disconnect the discharged battery from the vehicle.
- Switch off all unnecessary electrical consumers.
- Do not lean over the battery during jump starting.
- Do not allow the terminals of one lead to touch those of the other lead.
- The vehicles must not come into contact with each other during the jump starting procedure.
- Apply handbrake. Select neutral gear.

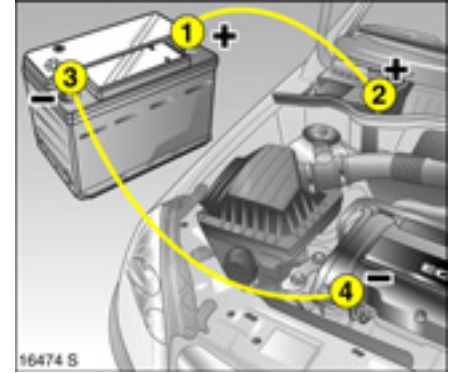

Lead connection order:

1. Connect the first lead to the positive terminal (1) of the booster battery.
2. Connect the other end of the lead to the positive terminal (2) of the discharged battery.
3. Connect the second lead to the negative terminal (3) of the booster battery.
4. Connect the other end of the second lead (4) to a vehicle ground point, such as the engine block or a screw connection in the engine suspension. Connect as far away from the discharged battery as possible.

Route the leads so that they cannot catch on rotating parts in the engine compartment.

To start the engine:

1. Start the engine of the vehicle providing the jump start.
2. After 5 minutes, start the other engine. Start attempts should be made at intervals of 1 minute and should not last longer than 15 seconds.
3. Allow both engines to idle for approx. 3 minutes with the leads connected.
4. Switch on electrical consumers (e.g. light, heated rear window) of the vehicle receiving the jump start.
5. Reverse above sequence exactly when removing leads.



### Towing your own vehicle

Disengage cap at bottom and remove downwards.

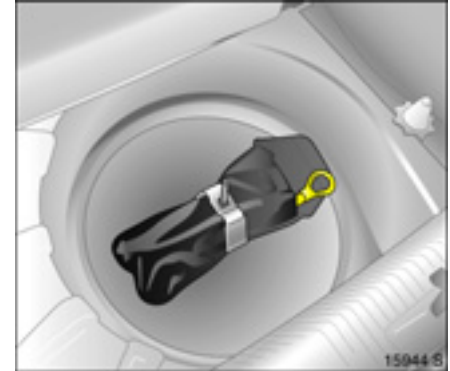

The towing eye is in the pouch or the stowage compartment for vehicle tools ↻ 133. Spare wheel ↻ 131.

For reasons of design, the spare wheel well insert ❄ must not be removed. The installation position is indicated by an arrow pointing to the direction of travel.



Screw in the towing eye anticlockwise as far as it will go until it stops in a horizontal position.

Attach a tow rope \* – or better still a tow rod \* – to the eye.

The towing eye must only be used for towing, not for recovering the vehicle.

Switch on ignition to release steering column lock and to permit operation of brake lamps, horn and windscreen wipers.

Select neutral gear.

**Caution**

Drive slowly. Do not drive jerkily. Excessive tractive force can damage the vehicle.

When the engine is not running, considerably more force is needed to brake and steer.

To prevent the entry of exhaust fumes from the towing vehicle, switch on the air recirculation system \* and close the windows.

Contact a workshop.

If the automatic clutch has been disengaged manually after a power failure on vehicles with Easytronic \*, towing is not permitted, ⇨ 105. In this case, contact a workshop immediately.

After towing, unscrew towing eye by rotating clockwise and insert and close the cap.

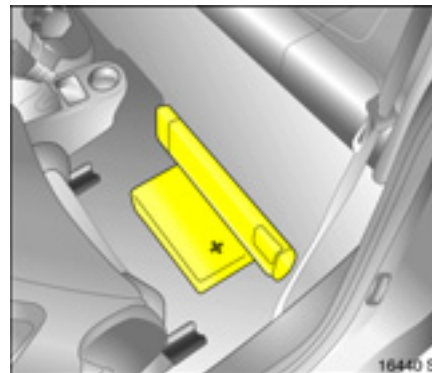

**Warning triangle ▲\* and First-aid kit ☉\***

Fasten the warning triangle and first-aid kit (cushion) to the flooring behind the seats with Velcro straps, as illustrated.

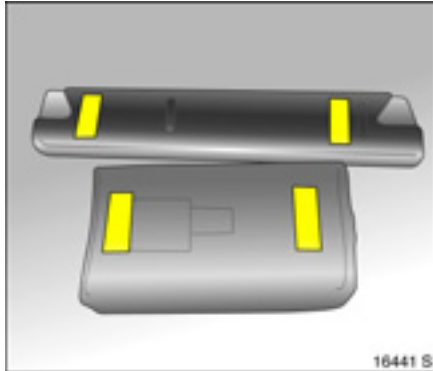

Fasten the Velcro straps to the warning triangle and the first-aid kit (cushion) as illustrated.

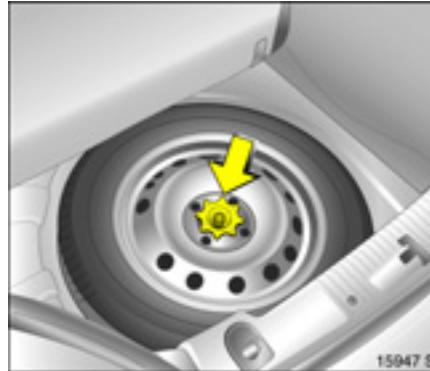

### Spare wheel ❄

Some vehicles are equipped with a tyre repair aerosol instead of a spare wheel  
 ⇨ 137.

The spare wheel is stowed in the luggage compartment, held in place under a floor cover with a wing nut.

Close retractable steel roof ⇨ 36.

Fold luggage compartment partition forwards ⇨ 47.

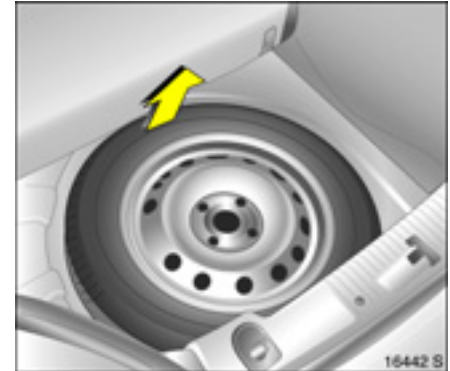

Pull the spare wheel forward and then upward out of the wheel well.

### General information

Depending on version, the spare wheel may be in the form of a temporary spare wheel ✱. Refer to the notes on this page and ↻ 125, ↻ 176.

On vehicles with alloy wheels ✱, the spare wheel may have a steel rim.

Use of a spare wheel together with winter tyres could alter driving characteristics. Have the defective tyre replaced as soon as possible.

Use of a spare wheel that is smaller than the other wheels could alter driving characteristics. In many countries, it is only permitted as a temporary spare wheel. Have the defective tyre replaced as soon as possible.

### Notes on temporary spare wheel ✱

- The use of the temporary spare wheel may affect the handling of the vehicle, particularly if winter tyres ✱ are being used. The Electronic Stability Programme (ESP<sup>®</sup>Plus) ✱ may switch itself off. Replace defective tyre as soon as possible, balance wheel and fit to vehicle.
- Fit only one temporary spare wheel.
- Do not drive faster than 50 mph (80 km/h).
- Take bends slowly.
- Do not use the temporary spare wheel for a lengthy period.
- Replace temporary spare wheel with full specification wheel without delay.
- Tyre chains are not permitted on the temporary spare wheel. If tyre chains have to be used after a front wheel puncture, fit temporary spare wheel to the rear axle and fit a rear wheel to the front axle. Check tyre pressure and correct if necessary ↻ 122, ↻ 176.
- Read notes on temporary spare wheel on ↻ 125, ↻ 176.

### Notes on directional tyres ✱

Fit directional tyres such that they roll in the direction of travel. The rolling direction is indicated by a symbol (e.g. an arrow) on the sidewall.

The following applies to tyres fitted opposing the rolling direction:

- Driving characteristics may be altered. Have the defective tyre replaced as soon as possible.
- Do not drive faster than 50 mph (80 km/h).
- Drive especially carefully in wet or snowy weather.

Further notes on directional tyres ↻ 122.



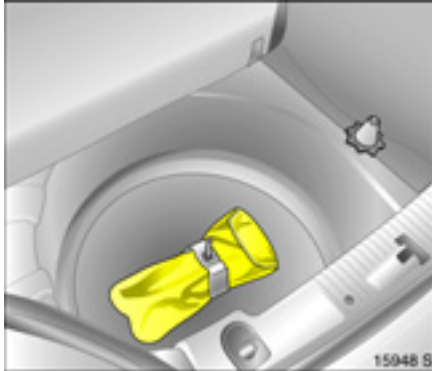



### Jack and vehicle tools

The jack and the vehicle tools have been specially developed for your vehicle and must only be used on that vehicle. Only use jack for changing wheels.





The jack and vehicle tools are located in a pouch or in a stowage compartment in the spare wheel well in the luggage compartment.

For reasons of design, the spare wheel well insert  must not be removed. The installation position is indicated by an arrow pointing to the direction of travel.

### Changing wheels

Some versions have tyre repair aerosol instead of a spare wheel .

Make the following preparations and observe the following information:

- Park the vehicle on a level, firm and non-slippery surface. The front wheels must be in the straight-ahead position.
- Close retractable steel roof .
- Switch on the hazard warning lamps, apply the handbrake, engage first gear or reverse.
- Erect warning triangle as required. Warning triangle .
- Remove the spare wheel .
- Never change more than one wheel at a time.
- Use the jack  only to change wheels.
- If the ground on which the vehicle is standing is soft, a solid board (max. 1 cm thick) should be placed under the jack .
- Block the wheel diagonally opposite the wheel to be changed by placing wedge blocks or equivalent in front and behind the wheel.
- No people or animals may be in the vehicle when it is jacked-up.
- Never crawl under a jacked-up vehicle.
- Do not start the vehicle when it is raised on the jack.
- Before screwing in the wheel bolts, clean them and lightly coat the cone of each wheel bolt with commercially available grease. Make sure that the bolt threads are not greased.

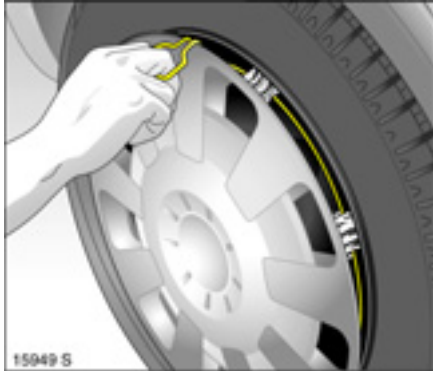

1. Pull off the wheel trim with the hook ✱. Vehicle tools ⇨ 133.

If the wheel trim has visible wheel bolts ✱, the trim can remain on the wheel. The retaining washers ✱ on the wheel bolts must not be removed.



Alloy wheels ✱: Prise off the wheel trim ✱ with a screwdriver. Protect the rim by placing a soft cloth between the screwdriver and the alloy wheel.

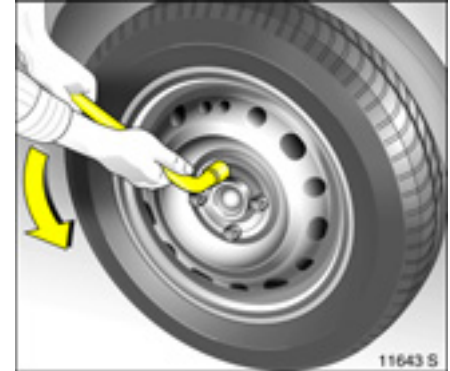

2. Push the wheel bolt wrench ✱ on as far as possible and slacken the wheel bolts half a turn.

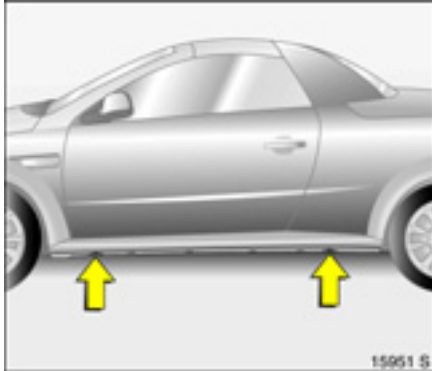

3. The jacking points are marked on the bottom edge of the vehicle.

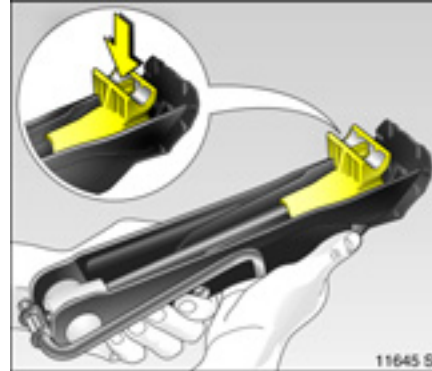

4. Set the jack \* to the necessary height. Position the jack arm at the front or rear so that the jack claw (arrowed in illustration) spans the vertical base and engages in the recess in the base. Make sure it is securely positioned.

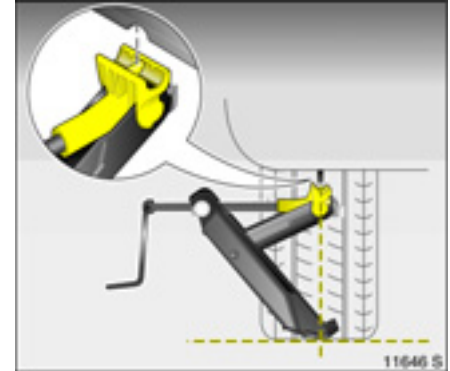

The edge of the jack base must be on the ground directly below the jacking point in a manner that prevents it from slipping.

Raise vehicle by turning crank handle.

If this edge of the jack base is no longer directly below the jacking point, carefully lower the vehicle immediately, reposition the jack and raise the vehicle again.

### 5. Unscrew the wheel bolts.

If the wheel bolts have retaining washers ✱, they must not be removed.

### 6. Change wheel.

Notes on spare wheel ⇨ 131.

Notes on temporary spare wheel ⇨ 132.

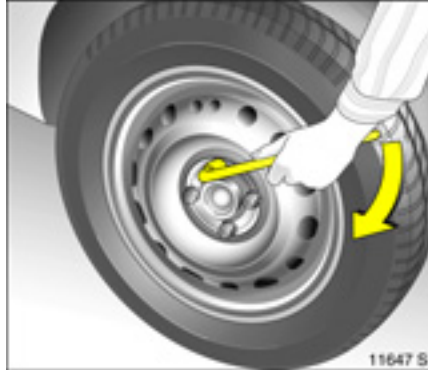

7. Screw in the wheel bolts. Push the wheel bolt wrench ✱ on as far as possible and tighten the wheel bolts slightly.

8. Lower vehicle.

9. Push the wheel bolt wrench ✱ on as far as possible and tighten in a crosswise sequence. Tightening torque is 110 Nm.

10. Before refitting the wheel trim, clean the wheel around the retaining clips. Valve symbol ✱ on back of wheel trim must point towards valve on wheel.

Position and engage wheel trim.

Alloy wheels ✱: Align and refit wheel bolt caps ✱.

11. Stow removed wheel with jack and warning triangle ⇨ 130, ⇨ 133.

12. Check the tyre pressure of the newly mounted wheel.

13. Have the wheel bolt tightening torque (110 Nm) checked.

14. Replace the faulty tyre on the wheel that was removed.



### Tyre repair aerosol \*

Minor damage to the tyre tread and sidewall, e.g. foreign bodies, can be remedied with the tyre repair aerosol.

In the event of a flat tyre:

- Park the vehicle on a level, firm and non-slippery surface.
- Switch on the hazard warning lamps, apply the handbrake, engage first gear or reverse.
- Erect warning triangle as required. Warning triangle ⇨ 130.

The tyre repair aerosol is located in the luggage compartment in the spare wheel well.

1. Remove foreign bodies from the tyre and turn the wheel so that the tyre valve is horizontal, that is to say at the midline of the wheel.
2. Completely relieve tyre pressure by pressing the valve core inward with a screwdriver.
3. Shake the aerosol can well. If temperatures are low, warm the can with your hands or with the air vents in the vehicle interior, with the engine running and the heating on ⇨ 94.
4. Screw connecting piece on hose of aerosol to tyre valve.
5. Remove the seal. Hold the aerosol upright and depress the button until the aerosol has completely discharged. The tyre is then filled with sealant.
6. Unscrew the connector from the tyre valve.
7. Collapse the warning triangle and stow it behind the left seat.
8. Immediately drive 3 to 6 miles (5 to 10 km) at a speed of no more than 30 mph (50 km/h). This distributes the sealant throughout the tyre.
9. After first making sure there are no naked flames nearby, release the gas in the tyre as quickly as possible by pressing the valve core inward with a screwdriver. Fill the tyre with compressed air.
10. Check the tyre pressure at regular intervals.
11. Have the tyre repaired as soon as possible and inform the workshop that tyre repair aerosol was used.



The tyre repair aerosol allows for temporary use of the tyre; it merely allows for continued travel until the tyre can be changed.

Fold the used tyre repair aerosol in a cloth and stow in the luggage compartment.

The tyre repair aerosol can only be used once for repair and must then be replaced. Contact a workshop.

The tyre repair aerosol can only be used on one tyre at a time.

Follow national legislation when disposing of used tyre repair aerosol.

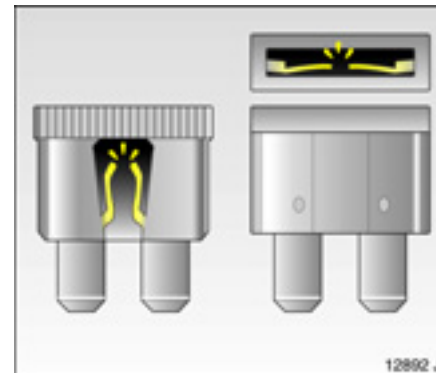

#### Note

#### ⚠ Warning

Do not drive faster than 30 mph (50 km/h).

Take bends slowly.

Have the repaired tyre replaced as soon as possible.

Steerability and driving behaviour may be impaired.

The tyre repair aerosol is highly inflammable.

Only stow the tyre repair aerosol in the luggage compartment.

Follow the instructions on the tyre repair aerosol.

## Electrical system

### Fuses

Data on the replacement fuse must match the data on the defective fuse.

Before replacing a fuse, turn off the respective switch and the ignition.

A defective fuse can be recognized by its melted wire. A new fuse should only be installed after the cause of the trouble has been rectified.

To help in replacing fuses, there is a special fuse extractor in the fuse box ❄.

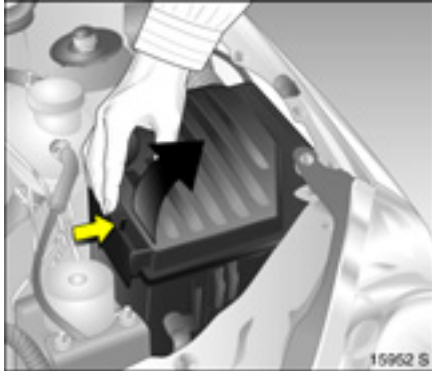

### Fuse box

The fuse box is located in the engine compartment next to the coolant expansion tank.

Disengage cover of fuse box from lug and lift off.

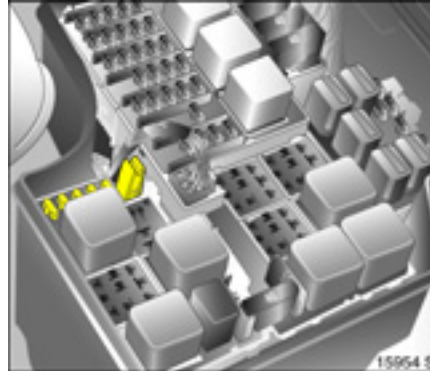

Place spare fuses at the point provided in the fuse box; next to this on the right is the fuse extractor for changing fuses.

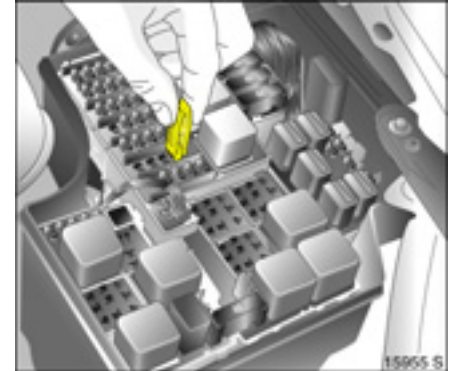

Slot fuse extractor onto fuse and withdraw it.

Always use fuses with the correct current rating. This is shown on each fuse, and is also indicated by the fuse colour and the plug-in location in the fuse box.



No.	Circuit
5	Electric window (left)
6	–
7	–
8	Ignition switch, starter
9	Injection system, fuel pump
10	Horn
11	Central control unit
12	Information display, Infotainment system: engine Z 13 DT

### Fuses and the most important circuits they protect

Some circuits may be protected by several fuses.

The illustrations on pages 140, 141 depict the fuse boxes of vehicles with engine Z 13 DT.

Fuse boxes of other engines are depicted on pages 142, 143.

#### No. Circuit

- 1 Central control unit
- 2 Engine control unit

#### No. Circuit

- 3 Instruments, information display, light switch, horn, hazard warning lamps, immobiliser
- 4 –



- No. Circuit**
- 13 Vauxhall alarm system
  - 14 Heated exterior mirrors
  - 15 Windscreen washer system
  - 16 Courtesy lamp
  - 17 Central control unit
  - 18 Heated rear window



- No. Circuit**
- 19 Electric window (right)
  - 20 –
  - 21 –
  - 22 Central control unit, immobiliser
  - 23 Windscreen wipers

- No. Circuit**
- 24 Infotainment system, Information display, Light switch, Courtesy lamp, Instruments, ESP<sup>Plus</sup>
  - 25 Reversing lamps, cigarette lighter, accessory socket
  - 26 Seat heater (right)
  - 27 Seat heater (left)



**No. Circuit**

- 37 Right dipped beam, headlamp range adjustment
- 38 Tail lamp (left), parking lamp (left)
- 39 Tail lamp (right), parking lamp (right)
- 40 Brake lamps, cruise control
- 41 Front fog lamps

**No. Circuit**

- 28 ABS
- 29 Retractable steel roof
- 30 Engine control unit
- 31 Air conditioning system
- 32 ABS, airbag

**No. Circuit**

- 33 Engine control
- 34 Diesel filter heater
- 35 Electric window, Infotainment system
- 36 Dipped beam (left)

- No. Circuit**
- 42 Fog tail lamp
  - 43 Main beam (left)
  - 44 Main beam (right)
  - 45 Ventilation fan
  - 46 Engine control unit
  - 47 Retractable steel roof
  - 48 Starter



- No. Circuit**
- 49 ESP®<sup>Plus</sup>
  - 50 ABS, ESP®<sup>Plus</sup>
  - 51 Petrol engine: Easytronic  
Diesel engine: Engine control unit

- No. Circuit**
- 52 Radiator fan
  - 53 Radiator fan
  - 54 –

### Bulb replacement

Switch off the ignition and turn off the relevant switch or close the doors.

Only hold a new bulb at the base! Do not touch the bulb glass with your bare hands.

Replace the bulb, checking that the data on the base matches that of the defective bulb.

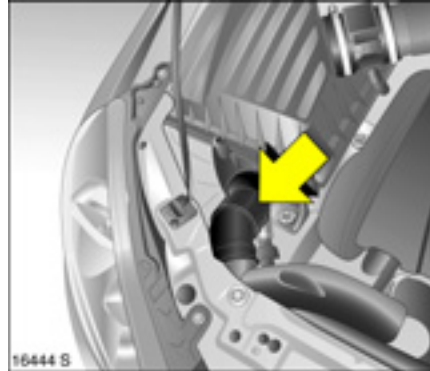

When replacing bulbs in the front right headlamp, detach the air hose from the air filter.

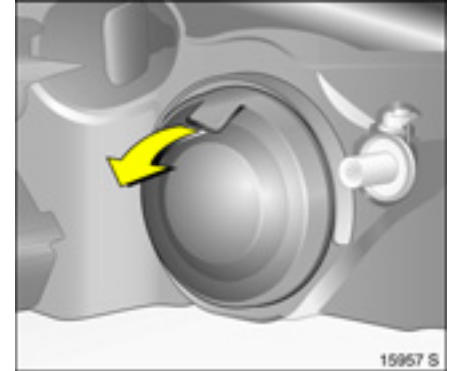

### Halogen headlamp system dipped and main beam

Headlamps have separate systems for dipped beam (inner bulbs) and main beam (outer bulbs).

#### Dipped beam

1. Open bonnet and engage support.
2. Remove headlamp protective cover.

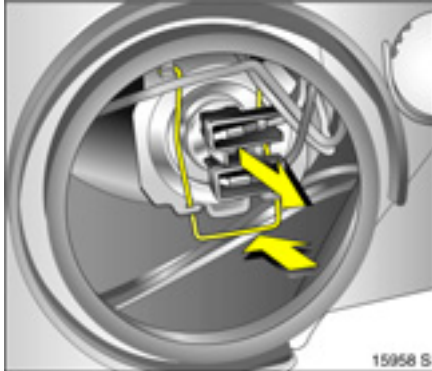

3. Detach plug connector from bulb.
4. Disengage spring wire clip from retaining lugs by moving it sideways and swivel it upward.
5. Remove bulb from reflector housing.

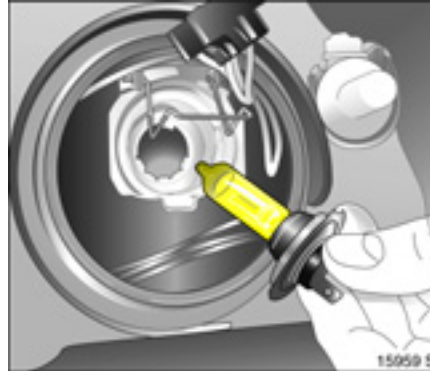

6. When fitting the new bulb, insert lugs in the reflector recesses.
7. Engage spring wire clip, attach plug connector onto bulb.
8. Place headlamp protective cover in position and close.

**Main beam**

Have bulbs changed by a workshop.

**Parking lamps**

Have bulbs changed by a workshop.

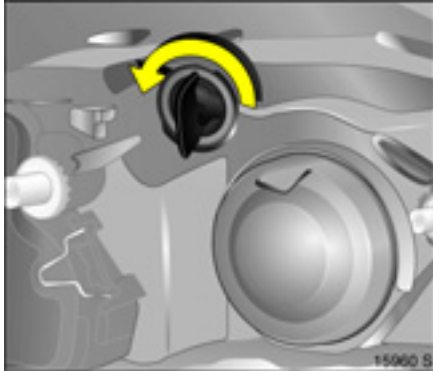

### Turn signal lamps

#### Front turn signal lamps

1. Open bonnet and engage support.
2. Rotate bulb holder anticlockwise and disengage.

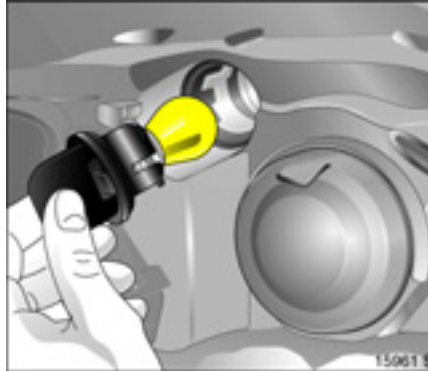

3. Remove bulb holder from reflector housing.
4. Push bulb into bulb holder slightly, rotate anticlockwise and remove.
5. Insert new bulb.
6. Engage bulb holder in reflector housing by rotating it clockwise.

#### Side turn signal lamp

Have bulbs changed by a workshop.

#### Front fog lamps \*

Have bulbs changed by a workshop.

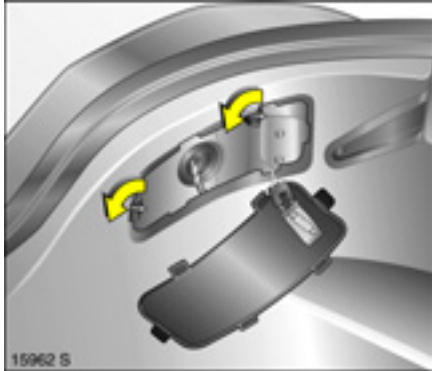

### Tail lamps

1. Open the luggage compartment.
2. Disengage cover of retaining lugs and remove.
3. Hold bulb housing from the outside and unscrew both retaining nuts.
4. Detach bulb housing towards the rear.

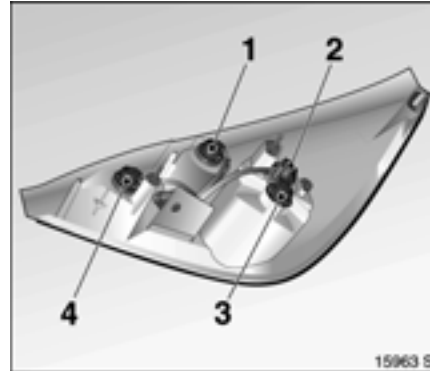

5. Disengage and remove bulb holder from bulb housing by rotating bulb holder anticlockwise:

- 1 = Reversing lamp
- 2 = Turn signal lamp
- 3 = Tail lamp/brake lamp
- 4 = Fog tail lamp (Country-specific version: fog tail lamp on one side only).

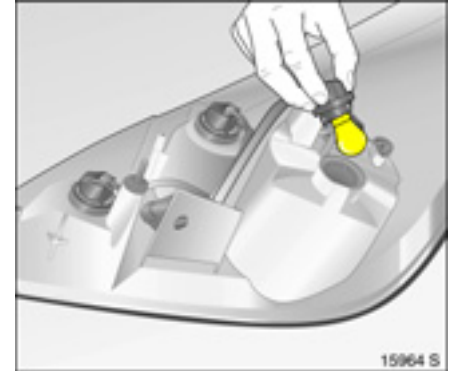

6. Push bulb into bulb holder slightly, rotate anticlockwise and remove.
7. Insert new bulb.
8. Engage bulb holder into bulb housing by rotating bulb holder clockwise.
9. Insert bulb housing in vehicle body and tighten retaining nuts by hand.
10. Fit cover.

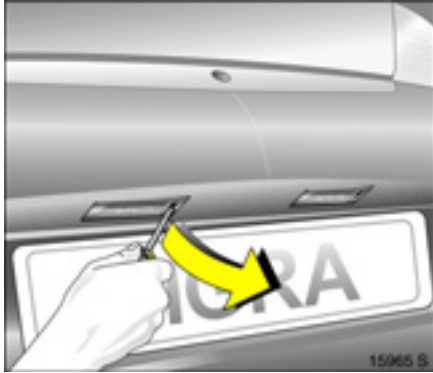

### Number plate lamp

1. Insert screwdriver vertically on right-hand side of bulb housing, exert pressure towards the right and disengage spring. Remove the bulb housing downwards.

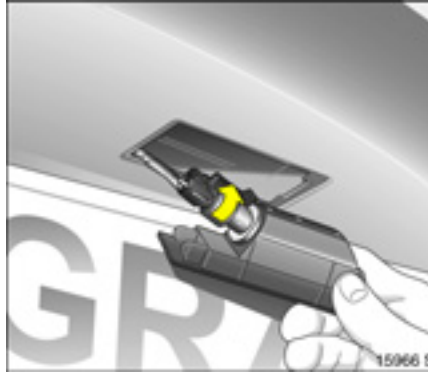

2. Rotate bulb holder anticlockwise and disengage.



3. Remove bulb from socket.
4. Insert new bulb.
5. Engage bulb holder by rotating clockwise in bulb housing.
6. Insert bulb housing in original position and engage.



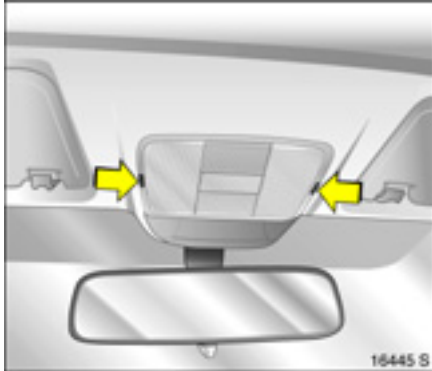

### Courtesy lamp

#### Front courtesy lamp

1. Lever the lens out of the housing at the points shown in the illustration.
2. Remove bulb from socket.
3. Insert new bulb.
4. Mount lens and engage in position.

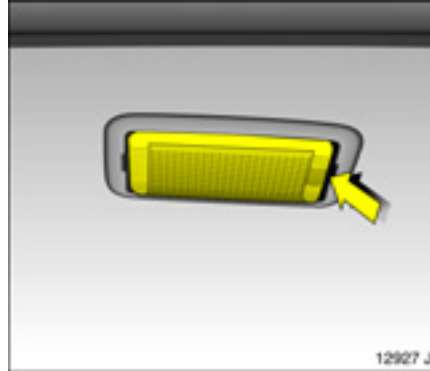

### Luggage compartment lamp

1. Pry the lens out with a screwdriver.



2. Press bulb slightly towards spring clip and remove.
3. Insert new bulb.
4. Insert lens in aperture and engage in position.

### Instrument illumination,

### Information display illumination

Have bulbs changed by a workshop.

## Vehicle care

When caring for your vehicle, observe all national environmental regulations, particularly when washing it.

Regular, thorough care helps to improve the appearance of your vehicle and maintain its value over the years. It is also a prerequisite for warranty claims for any paint or corrosion damage. The following pages contain tips for vehicle care which, if used properly, will help combat the unavoidable damaging effects of the environment.

### Washing

The paintwork of your vehicle is exposed to environmental influences. Wash and wax your vehicle regularly. When using automatic car washes, select a programme that includes waxing.

Bird droppings, dead insects, resin, pollen and the like should be cleaned off immediately, as they contain aggressive constituents which can cause paint damage.

When using a car wash, follow the instructions of the car wash manufacturer. Switch off windscreen wipers. Unscrew antenna rod ☼.

If you wash your vehicle by hand, make sure that the insides of the wings are also thoroughly rinsed out.

Clean edges and folds on opened doors and flaps as well as the areas they cover.

Thoroughly rinse off and leather-off the vehicle. Rinse leather frequently. Use separate leathers for paint and window surfaces: remnants of wax on the windows will impair vision.

### Polishing and waxing

Wax the vehicle regularly (at the latest when water no longer forms beads on the paintwork). Otherwise, the paintwork will dry out.

Polishing is necessary only if the paint has become dull or if solid deposits have become attached to it.

Paintwork polish with silicone forms a protective film, making waxing unnecessary.

Plastic body parts should not be treated with wax and polish.

### Wheels and tyres

Do not use high-pressure jet cleaners.

Clean wheels with a pH-neutral wheel cleaner.

Wheels are painted and can be treated with the same agents as the body.

### Paintwork damage

Rectify minor paintwork damage with a touch-up pen before rust forms. Have more extensive damage or rust areas repaired by a workshop.

### Exterior lamps

Headlamp and other lamp covers are made of plastic. Do not use any abrasive agents, do not use an ice scraper, and do not clean them dry.

### Plastic and rubber parts

Plastic and rubber parts can be cleaned with the same cleaner as used to clean the body. Use interior cleaner if necessary. Do not use any other agent. Avoid solvents and petrol in particular. Do not use high-pressure jet cleaners.

**Interior and upholstery**

Only clean the vehicle interior, including the instrument panel facia and panelling, with a dry cloth or interior cleaner.

The instrument panel should only be cleaned using a soft damp cloth.

Clean fabric upholstery with a vacuum cleaner and brush. Remove stains with an upholstery cleaner.

Clean seat belts with lukewarm water or interior cleaner.

Caution
Close Velcro fasteners as open Velcro fasteners on clothing could damage seat upholstery.

**Windows and windscreen wiper blades**

Use a soft lint-free cloth or chamois leather together with window cleaner and insect remover.

When cleaning the rear window, make sure the heating element inside the window is not damaged.

For mechanical removal of ice, use a sharp-edged ice scraper. Press the scraper firmly against the glass so that no dirt can get under it and scratch the glass.

Clean smearing wiper blades with a soft cloth and window cleaner.

**Locks**

The locks are lubricated at the factory using a high quality lock cylinder grease. Use de-icing agent only where absolutely necessary, as this removes grease and impairs lock function. After using de-icing agent, have the locks regreased by a workshop.

**Engine compartment**

Clean painted surfaces in the engine compartment like any other painted surface.

It is advisable to wash the engine compartment before and after winter and preserve it with wax. Before engine washing, cover alternator and brake fluid reservoir with plastic sheeting.

When washing the engine with a steam-jet cleaner, do not direct the steam jet at components of the Anti-lock Braking System ❄, the automatic air conditioning system ❄ or the belt drive and its components.

After an engine wash, have all engine room components preserved thoroughly by a workshop using protective wax.

Do not use high-pressure jet cleaners.

**Underbody**

Some areas of the vehicle underbody have a PVC undercoating while other critical areas have a durable protective wax coating.

After the underbody is washed, check the underbody and have more protective wax applied if necessary.

Bitumen/rubber materials could damage the PVC coating. Have underbody work carried out by a workshop.

Before and after winter, wash the underbody and have the protective wax coating checked.

**Retractable steel roof**

Coat all seals, such as on the roof and the windscreen frame, with silicone oil from time to time. A constant close contact between the fine rubber lips and the sealing faces ensures a tight fit and low closing forces.

Do not use high-pressure jet cleaners.

## Service and Maintenance

Scheduled maintenance .....	152
Additional service work .....	156
Recommended fluids and lubricants .	156
Inspection system .....	158
Vauxhall genuine parts and accessories.....	159
Performing work .....	159
Engine oil.....	160
Diesel fuel filter .....	162
Coolant .....	162
Brake fluid .....	164
Windscreen wiper replacement .....	165
Windscreen washer system.....	165
Battery .....	165
Protecting electronic components .....	166
Laying the vehicle up for a long period of time.....	166
Putting the vehicle back into service .	167

### Scheduled maintenance

The service intervals apply to normal conditions of use. For extreme operating conditions ⇨ 156.

Service interval display ⇨ 158.

### Service intervals

Every 20,000 miles (30,000 km) or annually, whichever occurs first.

### Confirmation

Service confirmation is given in the fields provided in the Service and Warranty Booklet. The date and mileage/kilometre reading are given with the stamp and signature of the servicing garage.

Ensure that the Service and Warranty Booklet is correctly completed, as an uninterrupted service record is crucial in the event of warranty claims or complaints, and is also an advantage when reselling the vehicle.

Service Plan

Service work	after years <sup>1)</sup>	1	2	3	4	5
	miles (x1000) <sup>1)</sup>	20	40	60	90	120
	km (x1000) <sup>1)</sup>	30	60	90	120	150
Visually inspect control systems, lighting and signalling systems and airbag, test steering and ignition lock		x	x	x	x	x
Remote control: replace batteries (check second key).		Every 2 years				
Windscreen wipers, windscreen washer system, headlamp washer system, check and correct		x	x	x	x	x
Check and correct coolant level and anti-freeze (bright orange) <sup>2)</sup> , note coolant anti-freeze protection temperature in Service and Warranty Booklet (confirmation fields)		x	x	x	x	x
Test fluid-carrying hoses for leaks and firm attachment		x	x	x	x	x
Check and correct brake fluid level <sup>2)</sup>		x		x		x
Test battery terminals for firm seat and battery eye		x	x	x	x	x
Vehicle system check with TECH 2		x	x	x	x	x
Replace pollen filter or active charcoal filter			x		x	
⊕● If air is very dirty, has a high dust or sand content or high pollen level, if the air conditioning system has an odour		By agreement with customer / Vauxhall Authorised Repairer				
Replace air filter insert		Every 4 years / 40,000 miles / 60,000 km				
⊕ Replace spark plugs		Every 4 years / 40,000 miles / 60,000 km				
Inspect ribbed V-belts			x		x	
⊕ Replace ribbed V-belts Z 13 DT		Every 10 years / 120,000 miles / 150,000 km				

<sup>1)</sup> Whichever occurs first.

<sup>2)</sup> In the case of excessive loss / leakage, additional work upon agreement with customer.

⊕ Additional work.

● Under extreme operating conditions and if necessary for country-specific conditions, the intervals are shortened.

## 154 Service and Maintenance

Service work	after years <sup>1)</sup>	1	2	3	4	5
	miles (x1000) <sup>1)</sup>	20	40	60	90	120
	km (x1000) <sup>1)</sup>	30	60	90	120	150
⊕ Replace toothed belts and tensioning roller Z 18 XE	Every 6 years / 60,000 miles / 90,000 km					
Change engine oil and filter	x	x	x	x	x	
⊕● Drain water from fuel filter, diesel (for high residual humidity and/or lower quality fuel)	x	x	x	x	x	
Replace fuel filter and drain out water, diesel (quality EN 590) Z 13 DT		x		x		
Check handbrake and adjust (wheel unloaded); inspect wheel mounting and suspension front and rear, brake lines, brake hoses, fuel lines and exhaust system		x		x		
Check external bodywork / underfloor corrosion protection, note damage in Service and Warranty Booklet	x	x	x	x	x	
⊕● Inspect front and rear brakes <sup>2)</sup>		x		x		
Annual Service if the annual driving distance is over 12,000 miles (20,000 km)						
Inspect engine, transmission (MT, Easytronic), Air conditioning compressor for leaks <sup>2)</sup>	x	x	x	x	x	
⊕● Remove, clean and inspect brake drums	Every 4 years / 40,000 miles / 60,000 km					

<sup>1)</sup> Whichever occurs first.

<sup>2)</sup> In the case of excessive loss / leakage, additional work upon agreement with customer.

⊕ Additional work.

● Under extreme operating conditions and if necessary for country-specific conditions, the intervals are shortened.

Service work	after years <sup>1)</sup>	1	2	3	4	5
	miles (x1000) <sup>1)</sup>	20	40	60	90	120
	km (x1000) <sup>1)</sup>	30	60	90	120	150
Inspect gaiters on steering, track rods, final drive		x	x	x	x	x
Check track rod ends and ball joints		x	x	x	x	x
⊕ Change brake and clutch fluid (Easytronic)		Every 2 years				
Release wheel fixings and tighten to torque 110 Nm			x		x	
Lightly grease or oil wheel bolt cones when fitting						
Check tyre condition. Check and correct tyre pressure (including spare wheel)						
For tyre repair aerosol, check fill level and expiry date every 3 years						
⊕ Annual Service if the annual driving distance is over 12,000 miles (20,000 km)		Every 2 years				
Inspect first-aid kit (presence in stowage compartment, completeness and expiry date), lashing eyes and warning triangle		Every 2 years				
Check and correct headlamp adjustment (including auxiliary lamps)			x		x	
Lubricate door hinges, check straps, lock cylinders, lock brackets, bonnet closure, tailgate hinges			x		x	
⊕● Clean and lubricate folding roof in dusty countries (by agreement with customer/Vauxhall Authorised Repairer)		x	x	x	x	x
Test drive, final check (steering and ignition lock, instruments and control indicators, entire braking system, steering, air conditioning, engine, bodywork and chassis), reset service interval display with TECH 2		x	x	x	x	x

<sup>1)</sup> Whichever occurs first.

⊕ Additional work.

● Under extreme operating conditions and if necessary for country-specific conditions, the intervals are shortened.

### Additional service work

#### Additional work ⊕

Additional work is work which is not necessary on every service, but may be performed at the same time as a regular service.

The time allowances for such work are not included in the scope of the regular service, and are invoiced separately. It is however more economic to perform this work as part of a scheduled service than as a separate task.

#### Extreme operating conditions ●

Conditions are considered extreme if one or more of the following circumstances occur frequently:

- cold starts,
- stop and go,
- caravan/trailer towing,
- gradients and/or high altitudes,
- poor road conditions,
- sand and dust,
- extreme temperature fluctuations.

Police vehicles, taxis and driving school vehicles are also classed as undergoing extreme operating conditions.

Under extreme operating conditions, it may be necessary to perform certain service work more frequently than at the scheduled intervals.

We recommend obtaining technical advice on the service requirements for your vehicle depending on the particular conditions of use.

### Recommended fluids and lubricants

Only use products which have been tested and approved. Damage caused by the use of operating materials which are not approved is not covered by the warranty.

#### Warning

Operating materials are hazardous and require corresponding care when handling. If swallowed, consult a doctor immediately. Do not inhale fumes and avoid skin contact. Keep out of the reach of children. Operating materials must not pollute waste water, surface water, ground water or soil. Dispose of empty containers correctly. Always remember that operating materials are harmful to health.



**Engine oil**

Engine oil is characterised by its quality and viscosity. When selecting an engine oil to use, quality is more important than viscosity.

**Engine oil for Service Plan**

GM-LL-A-025: Petrol engines

GM-LL-B-025: Diesel engines

GM General Motors Europe

LL Longlife

A or B Engine oil grade

025 Validity index

Vauxhall engine oil complies with classifications GM-LL-A-025 and GM-LL-B-025 and is therefore suitable for both petrol and diesel engines.

**Top up engine oil**

Oils from different manufacturers and makes can be mixed as long as the engine oil criteria (quality and viscosity) are observed.

Not every engine oil available on the market meets the quality requirements, so always check whether the specifications and classifications required are shown on the container.

If engine oil of the required quality is not available, no more than 1 litre of category ACEA A3/B4 or A3/B3 may be used (only twice between two oil changes). The viscosity must comply with requirements.

The use of engine oil category ACEA A1/B1 and A5/B5 is expressly prohibited as it can cause long-term damage to the engine under certain circumstances.

**Engine oil additives**

The use of engine oil additives can cause damage and invalidate the warranty.

**Engine oil viscosity**

Only use engine oil viscosities 0W-30, 0W-40, 5W-30 or 5W-40.

The SAE viscosity class indicates the flow capacity of the oil: In cold weather, the oil is more viscous than when warm.

Multigrade oil is indicated by two figures. The first figure followed by W indicates the viscosity at low temperature, and the second figure the viscosity at high temperature.



### Inspection system

In order to ensure economical and safe vehicle operation and to maintain the value of your vehicle, it is of vital importance that all maintenance work is carried out at the proper intervals as specified.

#### Fixed service interval

When service is due, **InSP** appears in the odometer display for approx. 10 seconds when the ignition is switched on. Have the next service performed by a workshop within one week or 300 miles (500 km), whichever occurs first.

The service interval display takes account of off-the-road periods during which the battery is disconnected.

#### Flexible service interval \*

The length of the service intervals is based on several parameters stemming from usage. For this reason, various engine-specific data is continually gathered and is used to calculate the remaining distance until the next service.

If the remaining distance is less than 1000 miles (1500 km), **InSP** is displayed with a remaining distance of 600 miles (1000 km) when the ignition is switched on and off. If less than 600 miles (1000 km) remains, **InSP** is displayed for several seconds. Have the next service performed by a workshop within one week or 300 miles (500 km), whichever occurs first.

Display of remaining distance:

1. Switch off ignition.
2. Briefly press the trip odometer reset button. The odometer reading is shown.
3. Press and hold the reset button for approx. 2 seconds. **InSP** and the remaining distance are displayed.

Further information on maintenance and the inspection system can be found in the Service and Warranty Booklet, which is in the glove compartment.

Have service work and repairs to the bodywork and components performed properly by a workshop in accordance with Vauxhall motors' recommendations, using Vauxhall genuine parts and accessories.

We recommend your Vauxhall Authorised Repairer, who has excellent knowledge of Vauxhall vehicles and is in possession of the necessary tools and current service instructions from Vauxhall. To avoid invalidating the warranty, use of a Vauxhall Authorised Repairer is recommended in particular during the warranty period. For further information see the Service and Warranty Booklet.

#### Separate anti-corrosion service

Carry out after the intervals specified in the Service and Warranty Booklet.

## Vauxhall genuine parts and accessories

We recommend that you use "Vauxhall genuine parts and accessories" and conversion parts released expressly for your vehicle type. These parts have undergone special tests to establish their reliability, safety and specific suitability for Vauxhall vehicles. Despite continuous market monitoring, we cannot assess or guarantee these attributes for other products, even if they have been granted approval by the relevant authorities or in some other form.

"Vauxhall genuine parts and accessories" and conversion parts approved by Vauxhall can be obtained from your Vauxhall Authorised Repairer, who can provide expert advice on permitted technical changes and ensure correct installation.



### Performing work

To avoid injury from moving parts and cables conducting ignition voltage, only carry out engine compartment checks (e.g. checking brake fluid or engine oil level) when the ignition is switched off.

#### **⚠ Warning**

Only perform engine compartment checks when the ignition is off.

The cooling fan may start operating even if the ignition is off.

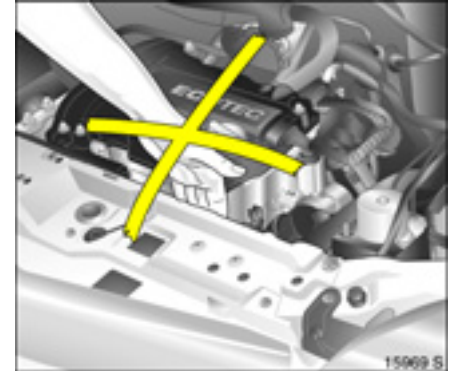

#### **⚠ Warning**

The ignition system \* and Xenon headlamps \* use extremely high voltage. Do not touch.

To aid identification, the caps used when topping up engine oil, coolant and washer fluid as well as the oil dipstick are coloured yellow.

### Engine oil

For vehicles with engine oil level check ✱, the engine oil level is checked automatically ⇨ 70. We recommend checking the engine oil level before starting a long journey.

#### Caution

Important: It is the owner's responsibility to maintain the correct level of an appropriate quality oil in the engine.

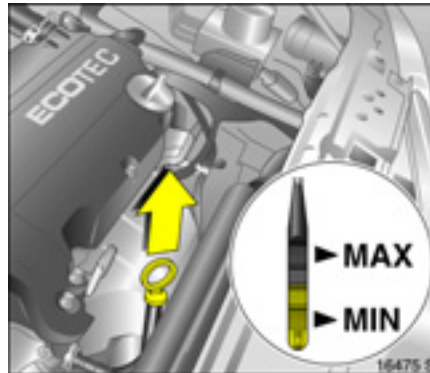

Check with the vehicle on a level surface. The engine must be at operating temperature and switched off for at least 5 minutes.

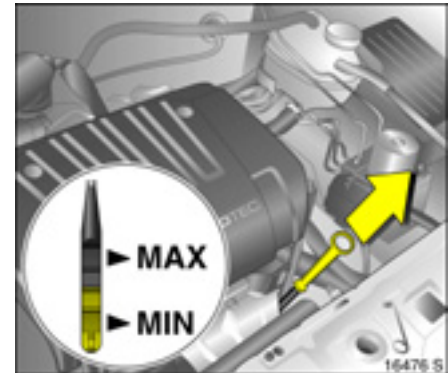

Pull out the dipstick, wipe it clean (use a fibre-free material), insert it to the stop on the handle, pull out and read the engine oil level.

Insert oil dipstick up to the stop surface on the handle, and twist half a turn.

Different dipsticks are used depending on engine variant.

When the engine oil level has dropped to the **MIN** mark, top up engine oil.

#### Caution

Do not allow the engine oil to drop below the minimum level!

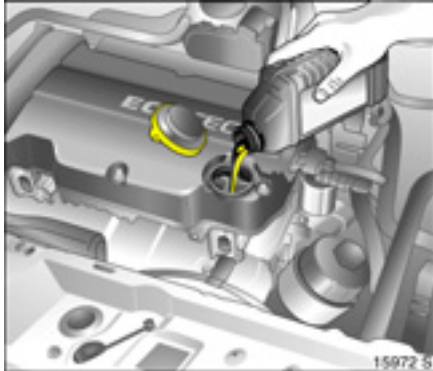

We recommend that you use the same engine oil as was used the last time it was topped up.

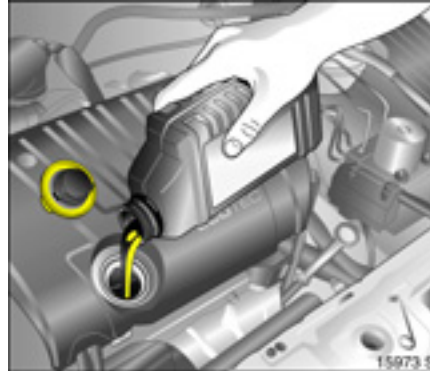

The engine oil level must not exceed the **MAX** mark on the dipstick.

**Caution**

If there is too much engine oil, the excess must be drained or suctioned out.

Top up to between the **MIN** and **MAX** marks ⇄ 178.

Fit the cap on straight and tighten it.

### Diesel fuel filter

On each engine oil change, have the fuel filter checked for any water residue by a workshop.

Illumination of control indicator  in the instrument cluster indicates water in the diesel fuel filter.

Have fuel filter checked at shorter intervals if the vehicle is subjected to extreme operating conditions such as high humidity (primarily in coastal areas), extremely high or low outside temperatures and substantially varying daytime and night-time temperatures.

### Coolant

The coolant provides anti-freeze protection down to approx. -28 °C.

#### Caution

Only use approved anti-freeze. Coolant additives for additional corrosion protection and to seal minor leaks can cause function problems. No liability is accepted for damage caused by the use of coolant additives.

#### Warning

Anti-freeze is a danger to health; it must therefore be kept in the original container and out of the reach of children.

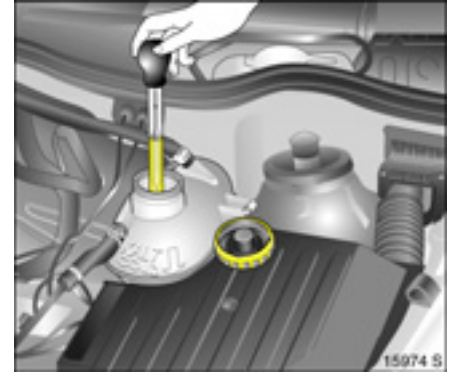

#### Anti-freeze and corrosion protection

Before the start of winter, have a workshop check the anti-freeze protection. The anti-freeze level must guarantee protection down to approx. -28 °C. Insufficient anti-freeze will reduce the frost protection level and the corrosion protection. If necessary, add anti-freeze.

If coolant loss is topped up with water, have concentration checked and add anti-freeze if necessary.

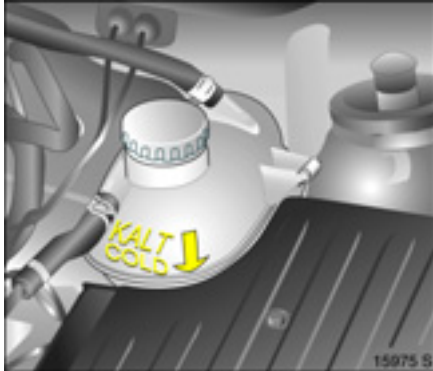

### Coolant level

In a closed cooling system, there is hardly any loss.

If the cooling system is cold, the coolant level should be above the **KALT/COLD** mark. Top up if the level is low.

### ⚠ Warning

Allow the engine to cool before opening the cap. Carefully open the cap, relieving the pressure slowly.

Top up with anti-freeze. If no anti-freeze is available, fill with clean tap water or distilled water. Have the anti-freeze concentration checked.

Have the cause of coolant loss rectified by a workshop.

### Caution

Too low a coolant level can cause engine damage.

Fit the cap on straight and tighten it.

### Brakes

A screeching noise indicates that the brake lining is at its minimum thickness.

Continued driving is possible. Have the brake lining replaced as soon as possible.

Once new brake linings are fitted, do not brake unnecessarily hard for the first 125 miles (200 km).

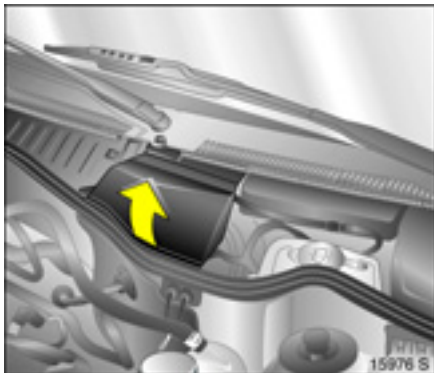

## Brake fluid

### Brake fluid level

#### **⚠ Warning**

Brake fluid is poisonous and corrosive. Do not allow it to come into contact with eyes, skin, fabrics or painted surfaces.

Open the cover of the brake fluid reservoir upwards, removing the sealing rubber on the front edge.



The brake fluid must be between the **MIN** and the **MAX** marks.

Absolute cleanliness is important when topping up, since contamination in the brake fluid can cause brake system malfunctions.

Only use approved high performance brake fluid. Only use DOT4 brake fluid.

After correcting the brake fluid level, have a workshop eliminate the cause of the brake fluid loss.

## Brake fluid change

Brake fluid is hygroscopic, i.e. it absorbs water. If the brakes become hot, such as when driving on long downhill stretches, vapour bubbles can occur in the water, which can have an extremely adverse effect on braking power (depending on the proportion of water).

Therefore observe the specified change intervals.

#### **⚠ Warning**

Have the brake fluid changed by a workshop. Observe the legal requirements for disposal of brake fluid to protect the environment and your health.



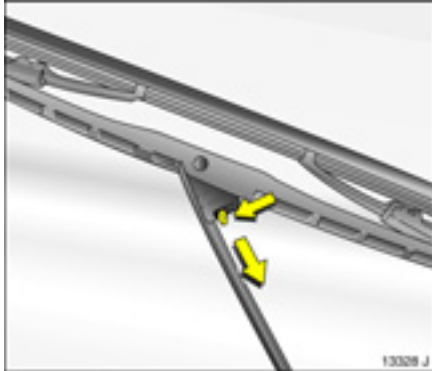

### Windscreen wiper replacement

Lift wiper arm. Move release lever and detach wiper blade.

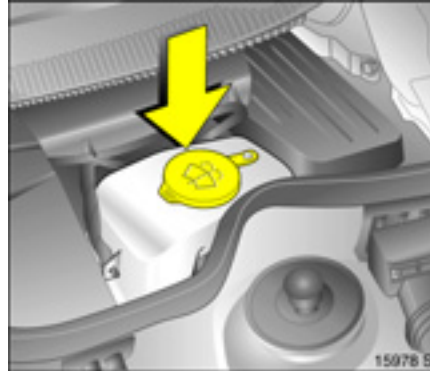

### Windscreen washer system

The washer bottle for the windscreen washer system is in engine compartment on the left-hand side.

Fill with clean water mixed with cleaner and anti-freeze.

Make sure there is sufficient anti-freeze protection.

When closing the reservoir, press the lid firmly over the beaded edge all the way round.

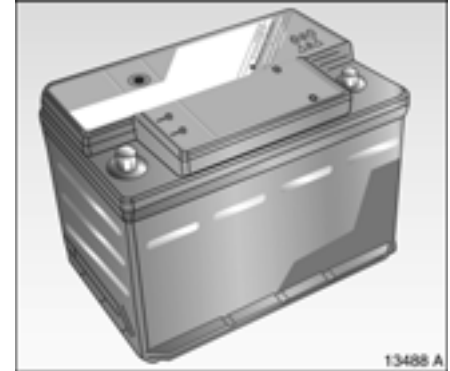

### Battery

The vehicle battery is maintenance-free.

Batteries do not belong in household waste. They must be disposed of at an appropriate recycling collection point.

Retrofitting of electrical or electronic accessories can discharge or add extra load to the battery. Take advice on the technical possibilities, e.g. use of a more powerful battery.

Laying up the vehicle for more than 4 weeks can lead to battery discharge. Disconnect the negative terminal of the vehicle battery.

Ensure the ignition is switched off before connecting or disconnecting the vehicle battery.

**Note**

The Vauxhall alarm system  siren must be deactivated as follows: switch the ignition on then off, disconnect the vehicle's battery within 15 seconds.

**Protecting electronic components**

In order to prevent faults in electronic components in the electrical system, never connect or disconnect battery with engine running or ignition switched on. Never start engine with battery disconnected, e.g. when starting using jump leads.

To avoid damaging the vehicle, do not make any modifications to the electrical system, e.g. connecting additional consumers or tampering with electronic control units (chip tuning).

 **Warning**

Electronic ignition systems generate very high voltages. Do not touch the ignition system; high voltage can be fatal.

**Laying the vehicle up for a long period of time**

If the vehicle is to be laid up for several months, the following work should be undertaken to prevent damage.

- Wash and wax the vehicle ⇨ 150.
- Have the wax in the engine compartment and underbody checked.
- Clean and preserve rubber seals.
- Change engine oil.
- Check anti-freeze and corrosion protection ⇨ 162.
- Check coolant level, if necessary top up with anti-freeze ⇨ 163.
- Drain the windscreen washer system.
- Increase tyre pressure to the value specified for full load ⇨ 122, ⇨ 176.

- Park vehicle in dry and well ventilated place. With manual transmission select first gear or reverse gear, and with Easytronic \* move selector lever to centre position before switching ignition off. Use wedges or the like to prevent vehicle from rolling.
- Do not apply handbrake.
- Disconnect the clamp from the negative terminal of the vehicle battery.

### **Putting the vehicle back into service**

Perform the following work before recommissioning the vehicle:

- Connect the clamp to the negative terminal of the vehicle battery.
- Check tyre pressure ⇨ 122, ⇨ 176.
- Top up windscreen washer system ⇨ 165.
- Check engine oil level ⇨ 160.
- Check coolant level ⇨ 163.
- Fit the number plate if necessary.

## Technical Data

Vehicle data.....	168
Engine data.....	170
Performance.....	171
Fuel consumption, CO <sub>2</sub> emissions .....	172
Weights, payload and roof load .....	174
Tyres .....	176
Capacities .....	178
Dimensions .....	179

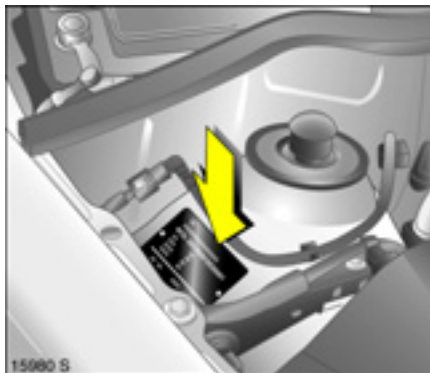

### Vehicle data

The technical data is determined in accordance with European Community standards. We reserve the right to make modifications. Specifications in the vehicle documents always have priority over those given in this manual.

The identification plate is located on the right MacPherson strut tower in the engine compartment.

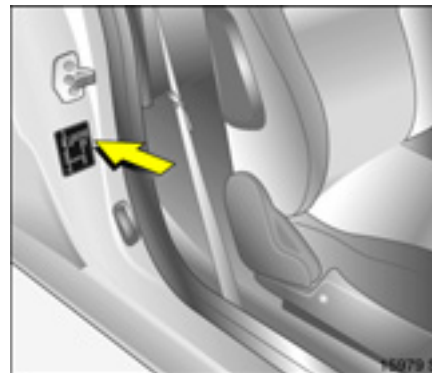

In other versions, the identification plate is attached to the right-hand front door frame.



Information on identification plate:

- 1 Manufacturer
- 2 Type approval number
- 3 Vehicle identification number
- 4 Gross vehicle weight rating
- 5 Permissible gross train weight
- 6 Maximum permissible front axle load
- 7 Maximum permissible rear axle load
- 8 Vehicle-specific or country-specific data

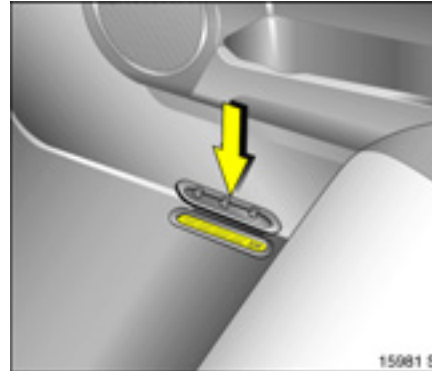

The vehicle identification number is stamped on the identification plate and on the right side of the floor of the vehicle under a cover between the front door and the seat.

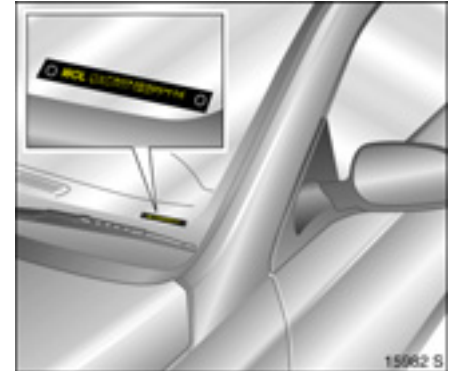

On some versions, the VIN can also be found on the instrument panel.

**Engine identifier and engine number:**  
Marked on left-hand side of engine in engine block.

## Engine data

Sales designation Engine identifier code	1.4 TWINPORT <b>Z 14 XEP</b>	1.8 <b>Z 18 XE</b>	1.3 CDTI <b>Z 13 DT</b>
Number of cylinders	4	4	4
Piston displacement [cm <sup>3</sup> ]	1364	1796	1248
Engine power [kW] at rpm	66 5600	92 6000	51 4000
Torque [Nm] at rpm	125 4000	165 4600	170 1750 to 2500
Type of fuel <sup>1)</sup>	Petrol	Petrol	Petrol
Octane rating RON <sup>2)</sup> recommended possible possible	<b>95</b> <sup>3)</sup> 98 <sup>3)</sup> 91 <sup>3)4)</sup>	<b>95</b> <sup>3)</sup> 98 <sup>3)</sup> 91 <sup>3)4)</sup>	– – –
Cetane number (CN) <sup>2)</sup>	–	–	<b>49 (D)</b> <sup>5)</sup>
Max. permissible engine speed, continuous operation (rpm) approx.	6200	6500	5100 to 5300
Oil consumption [l/1000 km]	0.6	0.6	0.6

1) Standard quality fuel, e.g. unleaded DIN EN 228, diesel DIN EN 590.

2) Standard quality fuels: D = Diesel; bold type: recommended fuel.

3) Knock control system automatically adjusts ignition timing according to type of fuel used (octane number).

4) Slight reduction in engine output and torque if 91 RON is used.

5) A lower value is possible with winter diesel fuels.

**Performance**

	Z 14 XEP	Z 18 XE	Z 13 DT
Maximum speed <sup>1)</sup> [mph / km/h]			
Sports transmission	112/180	127/204	104/167
Easytronic	111/178	–	–

<sup>1)</sup> The maximum speed is achievable with a maximum of half payload. Optional equipment may reduce the specified maximum speed of the vehicle.

### Fuel consumption, CO<sub>2</sub> emissions

Directive 80/1268/EEC (last amended by 2004/3/EC) has been applicable to the measurement of fuel consumption since 1996.

The directive is oriented to actual driving practices: Urban driving is rated at approx.  $\frac{1}{3}$  and extra-urban driving at approx.  $\frac{2}{3}$  (urban and extra-urban consumption).

Cold starts and acceleration phases are also taken into consideration.

The specification of CO<sub>2</sub> emission is also a constituent of the directive.

The figures given must not be taken as a guarantee for the actual fuel consumption of a particular vehicle.

All values are based on the EU base model with standard equipment.

The calculation of fuel consumption as specified by directive 2004/3/EC takes account of the vehicle's kerb weight, ascertained in accordance with the aforementioned regulation. Optional extras may result in slightly higher fuel consumption and CO<sub>2</sub> emission levels than those quoted.

To convert l/100 km into mpg, divide 282 by number of litres/100 km.

Saving fuel, protecting the environment  
♻ 108



**Fuel consumption, CO<sub>2</sub> emissions**

	Z 14 XEP	Z 18 XE	Z 13 DT
Sports transmission/Easytronic			
Fuel consumption			
urban [l/100 km]	8.1/ 8.0	10.4/-	5.8/-
rural [l/100 km]	5.0/ 4.9	5.8/-	3.9/-
total [l/100 km]	6.1/ 6.0	7.5/-	4.6/-
CO <sub>2</sub> [g/km]	146/144	179/-	124/-

**Weights, payload and roof load**

The payload is the difference between the permitted gross vehicle weight (see identification plate ⇨ 168) and the EC kerb weight.

Optional equipment and accessories increase the kerb weight, which means that the payload will also change slightly.

Note weight ranges in the vehicle documents and on the rating plate.

The combined total of front and rear axle loads must not exceed the permissible gross vehicle weight. For example, if the front axle is bearing its maximum permissible load, the rear axle can only bear a load that is equal to the gross vehicle weight minus the front axle load.

Roof loads are not permitted.

Driving hints ⇨ 106.

**Kerb weight<sup>1)</sup>**

<b>Tigra retractable steel roof</b>	<b>Engine</b>	<b>Sport transmission</b>	<b>Easytronic</b>
<b>without air conditioning [kg]</b>	Z 14 XEP	1235	1235
	Z 18 XE	1265	–
	Z 13 DT	1278	–
<b>with air conditioning [kg]</b>	Z 14 XEP	1260	1260
	Z 18 XE	1290	–
	Z 13 DT	1303	–
<b>with maximum equipment [kg]</b>	Z 14 XEP	1305	1305
	Z 18 XE	1335	–
	Z 13 DT	1348	–

<sup>1)</sup> According to EC Directive 70/156/EC, including assumed weights for driver (68 kg), luggage (7 kg) and all fluids (tank 90% full).

## Tyres

### Restrictions

Not all tyres available on the market currently meet the structural requirements. We recommend that you consult a Vauxhall Authorised Repairer concerning suitable tyre makes.

These tyres have undergone special tests to establish their reliability, safety and specific suitability for Vauxhall vehicles. Despite continuous market monitoring, we are unable to assess these attributes for other tyres, even if they have been granted approval by the relevant authorities or in some other form.

Further information ⇨ 121.

### Winter tyres \*

Tyres of size 185/60 R 15, 205/50 R 16 and 205/45 R 17 must not be used as winter tyres.

If you use winter tyres \*, the spare wheel may still be fitted with a summer tyre. If you use the spare wheel the vehicle's handling may be altered. Obtain a replacement for the faulty tyre as soon as possible, and have the wheel balanced and fitted to the vehicle.

Further information ⇨ 121.

### Tyre chains \*

Tyre chains are only permitted on the front wheels. Tyre chains must not be used on the temporary spare wheel \*.

Always use fine mesh chains that add no more than 10 mm to the tyre tread and the inboard sides (including chain lock).

Tyre chains are not permitted on tyres of size 185/60 R 15, 205/50 R 16 or 205/45 R 17.

Further information ⇨ 121.

## Wheels

Wheel bolt tightening torque: 110 Nm.

### Spare wheel \*

Depending on design, the spare wheel is designed as a temporary spare wheel \*. When using the spare wheel, the driving characteristics may be modified. Replace the faulty tyre as soon as possible, balance the wheel and refit to vehicle. Follow the notes on this page and ⇨ 125, ⇨ 131.

On vehicles with alloy wheels \*, the spare wheel may have a steel rim.

The spare wheel may be fitted with a smaller tyre<sup>1)</sup> and smaller wheel than the wheels fitted to the vehicle.

### Tyre pressure<sup>2)</sup>

The specified tyre pressures are valid for cold tyres. Increased tyre pressure resulting from extensive driving should not be reduced. The pressures specified on the next page apply to both summer and winter tyres.

Further information ⇨ 121 to ⇨ 125.

<sup>1)</sup> Country-specific version: In some countries, the spare wheel may only be used as a temporary spare wheel.

<sup>2)</sup> 1 bar corresponds to 100 kPa / 14.5 psi.

**Tyre pressure**

	Tyres	Tyre pressure for load with one person and light luggage		Tyre pressure for full load	
		Front [psi/bar]	Rear [psi/bar]	Front [psi/bar]	Rear [psi/bar]
Z 14 XEP, Z 18 XE, Z 13 DT	185/55 R 15	36/2.5	36/2.5	36/2.5	36/2.5
	185/60 R 15, 205/50 R 16, 205/45 R 17	33/2.3	30/2.1	33/2.3	30/2.1
Spare wheel ✱	185/55 R 15	36/2.5			

## 178 Technical Data

---

### Capacities

Engine oil

Engine	Z 14 XEP	Z 18 XE	Z 13 DT
--------	----------	---------	---------

---

Inc. Filter [litres]	3.5	4.25	3.2
----------------------	-----	------	-----

Between MIN and MAX [litres]	1.0	1.0	1.0
------------------------------	-----	-----	-----

---

### Fuel tank

---

Petrol/diesel, nominal capacity [litres]	45	45	45
--	----	----	----

---

**Dimensions**

	<b>Tigra</b>
Length [mm]	3921
Width without exterior mirrors [mm]	1684
Width with two exterior mirrors [mm]	1905
Height [mm]	1376
Wheelbase [mm]	2491
Turning circle diameter [m]	11.00

## Index

**A**

ABS (Anti-lock Braking System) .....	120
Accessories.....	53, 62, 130
Accessory socket .....	63
Air conditioning system .....	96
Air intake.....	99
Air recirculation system.....	97
Air vents .....	93
Airbags.....	54
Alarm.....	31
Alarm system .....	29
Alternator.....	69
Antenna .....	90, 150
Anti-corrosion service.....	158
Anti-freeze .....	162
Anti-freeze protection.....	162, 165
Anti-knock quality of fuel Octane number.....	170
Anti-theft locking system.....	24
Anti-theft protection .....	14
Aquaplaning.....	124
Ashtray.....	64

**B**

Battery.....	107, 165
Interruption of power supply	25, 34, 105
Battery discharge protection .....	89
Before starting off .....	12
Belt tensioners .....	50
Bleeding, diesel fuel system.....	126
Bonnet .....	126
Boot, see Luggage compartment....	26, 47
Brake assist.....	121

Brake system .....	119
Brakes	
ABS.....	120
Brake assist.....	121
Brake servo unit.....	106
Footbrake.....	121
Handbrake.....	121
Bulb replacement.....	144
Bulbs.....	144

**C**

Capacities .....	178
Car Pass .....	20
Care.....	150
Catalytic converter.....	112, 114
Central locking system.....	22, 23
Changing the remote control battery ...	23
Changing tyre/wheel type .....	121
Changing wheels .....	133
Chassis number, see Vehicle identification number .....	169
Child restraint system .....	53
Cigarette lighter .....	63
Climate control.....	92
Clutch operation.....	105
CO <sub>2</sub> emissions.....	172
Coin holder .....	65
Cold start .....	107
Contrast .....	80
Control indicators.....	8, 66
Coolant .....	162
Coolant level.....	163
Coolant temperature display .....	72
Coolant thermometer .....	72



Correcting time .....	79
Courtesy lamp.....	89
Courtesy lamps	
Bulb replacement.....	149
Cruise control .....	116

**D**

Dashboard, see Instrument panel.....	6
Data.....	20, 168
Date .....	76
Daytime running lamps.....	86
Decommissioning .....	166
Demisting and defrosting	
Windows .....	96
With the air conditioning system.....	98
Diesel fuel filter .....	162
Diesel fuel system .....	126, 162
Dimensions .....	179
Dipped beam .....	9, 86
Bulb replacement.....	144
Display.....	74
Display mode .....	80
Door locks.....	20, 151
Driving abroad.....	110
Headlamps.....	89
Driving hints .....	106

**E**

Easytronic.....	12, 100
Driving programmes .....	102
Fault.....	104
Interruption of power supply .....	105
Kickdown .....	103, 104
Selector lever.....	12, 101
Winter programme .....	103
Economical driving.....	108
Electric power-assisted steering .....	70, 106
Electric windows .....	32
Electrical system .....	138, 166
Electronic components.....	166
Electronic immobiliser .....	21
Electronic Stability Programme .....	114
Engine code .....	170
Engine control indicator.....	113
Engine oil.....	157
Additives .....	157
Topping up.....	157
Viscosity.....	157
Engine oil consumption.....	106, 170
Engine oil level .....	70
Engine oil pressure .....	68
Engine speed .....	107
Engine wash.....	151
Environmental protection .....	150
EPS (Electric Power-assisted Steering) ...	70
ESP (Electronic Stability Programme) ..	114
Exhaust control indicator.....	113
Exhaust gases.....	114
Exhaust system .....	106
Exterior mirrors .....	31, 32, 34

**F**

Fan .....	92, 94
Fault .....	34
Electric windows .....	34
Filling station	
Capacities .....	178
Engine oil level .....	160
Fuel.....	110, 170
Opening the bonnet.....	126
Tyre pressure .....	109, 176
Vehicle data.....	168, 169
Windscreen washer system .....	165
First-aid kit (cushion) .....	130
Flat tyre .....	133, 137
Fog tail lamp .....	87
Bulb replacement .....	147
Foot brake .....	119, 121
Front fog lamps.....	87
Bulb replacement .....	146
Front passenger airbag.....	54
Fuel.....	110, 170
Fuel consumption.....	108, 110, 171
Fuel filter .....	162
Fuel gauge.....	73
Fuel level .....	73
Fuel system, diesel .....	126
Fuses .....	138, 139

**G**

- Gears ..... 12, 105
- Generator, see Alternator ..... 69
- Genuine parts and accessories ..... 159
- Glove compartment ..... 65
- Graphical information display ..... 74
- Gross vehicle weight ..... 174

**H**

- Halogen headlamp system ..... 144
  - Driving abroad ..... 89
- Handbrake ..... 13, 14, 121
- Hazard warning lamps ..... 10, 88
- Head restraints ..... 46, 47
- Headlamp flash ..... 9, 87
- Headlamp range adjustment ..... 88
- Headlamps ..... 9, 86
  - Changing bulbs ..... 144
  - Daytime running lamps ..... 86
  - Driving abroad ..... 89
  - Front fog lamps ..... 87
  - Reversing lamps ..... 87
  - Warning device ..... 84
- Heated exterior mirrors ..... 11, 32, 34
- Heated rear window ..... 11, 32, 34
- Heated seats ..... 46
- Heating ..... 92, 95
  - Seats ..... 46
  - With the air conditioning system ..... 92
- Height adjustment
  - Steering wheel ..... 5
- High-pressure cleaners ..... 151
- Horn ..... 10

**I**

- Identification plate ..... 168, 169
- Idling ..... 105
- Ignition switch ..... 21
- Ignition system ..... 159, 166
- Immobiliser ..... 21
- Information display ..... 74
- Infotainment system ..... 91
- Instrument display ..... 72
- Instrument illumination ..... 89
  - Bulb replacement ..... 149
- Instrument panel ..... 6
- Instruments ..... 13, 66, 72
- Interior mirror ..... 5, 32
- Interruption of power supply ..... 83
  - Easytronic ..... 105
  - Electronic Stability Programme ..... 115

**J**

- Jack ..... 133, 135
- Jump leads ..... 127

**K**

- Keys ..... 2, 20
  - Extending ..... 20
  - Ignition lock ..... 13
  - Locking doors ..... 22, 23
  - Remove ..... 14
  - Starting ..... 13

**L**

- Language selection ..... 79
- Light switch ..... 9
- Lighting ..... 9, 86
  - Driving abroad ..... 89
- Loading ..... 174
- Lock cylinders ..... 20
- Locking doors ..... 2, 22, 23
- Locking from the inside ..... 24
- Locks ..... 151
- Luggage compartment
  - Lighting ..... 89
  - Loading ..... 174
  - Opening ..... 2, 26

**M**

- Main beam ..... 9, 87
  - Control indicator ..... 69
- Maintenance
  - Air conditioning system ..... 99
  - Anti-freeze protection ..... 162
  - Brake fluid ..... 164
  - Brakes ..... 163
  - Catalytic converter ..... 114
  - Engine oil ..... 160
  - Fuel consumption ..... 109
  - Tyre pressure ..... 122, 176
  - Tyres ..... 123
- Manual transmission ..... 12, 105
- Mirrors ..... 5, 31, 32
- Misted windows ..... 96, 98
- Mobile telephone ..... 91
- Muffler, see Exhaust system ..... 114

**N**

Number plate lamps	
Bulb replacement.....	148
Number plate lighting.....	148
Number plates.....	167

**O**

Octane numbers.....	170
Odometer.....	72
Oil.....	157
Additives.....	157
Topping up.....	157
Viscosity.....	157
Oil consumption.....	170
Oil pressure.....	68
Operating temperature.....	107
Outside temperature gauge.....	75
Overrun.....	107

**P**

Paintwork damage.....	150
Parking.....	14
Parking distance sensors.....	118
Parking lamps.....	9
Parking the vehicle.....	14
Parts.....	159
Pedals.....	107
Performance.....	171
Pollen filter.....	99
Power steering, see EPS	
(Electric Power-assisted Steering)	70, 106
Preheating.....	69

**R**

Radio.....	90
Radio equipment (CB).....	91
Rear lamp cluster.....	86
Bulb replacement.....	147
Rear window washer system.....	150
Refuelling.....	111
Fuel filler cap.....	111
Relays.....	138
Remote control.....	22
Central locking system.....	22
Steering wheel.....	90
Replacement keys.....	20
Retractable steel roof.....	17, 18, 34
Reversing lamps.....	87
Bulb replacement.....	147
Roof load.....	174
Running-in.....	106
Brakes.....	163

**S**

Safeguard against	
unauthorised use.....	13, 14, 21
Safety accessories.....	53, 130
Saving energy.....	108
Seat adjustment.....	44
Seat belts.....	49, 52, 151
Seat height adjustment.....	3, 45
Seat occupancy recognition.....	58
Seat position.....	45
Seats.....	3, 44
Heated.....	46
Selector lever.....	101

Self-diagnosis.....	51, 58, 120
Self-help.....	126
Central locking system.....	25
Information display.....	76
Remote control.....	22
Service.....	152
Service Intervals	
Additional work.....	156
Extreme operating conditions.....	156
Service intervals.....	152
Main Service.....	152
Service work.....	158
Side airbags.....	56
Spare keys.....	20
Spare wheel.....	131, 133
Speed.....	108, 109
Fuel consumption.....	108
Speedometer.....	72
Starting the engine.....	13, 21, 101
Steam-jet cleaners.....	151
Steering column lock.....	13, 14
Steering wheel adjustment.....	5
Steering wheel remote control.....	90
Stowage compartments.....	45, 64, 65
Sun visors.....	65
System settings.....	78

**T**

Tachometer.....	72
Tail lamps.....	86
Bulb replacement.....	147
Technical data.....	168
Telephone, see Mobile telephone.....	91
Temperature regulation.....	94
Temporary spare wheel.....	125, 132
The first 600 miles (1000 km).....	106
Tightening torque.....	136, 176
Time.....	76
Tools.....	133
Towing.....	129
Towing eye.....	129
Transmission	
Manual transmission.....	105
Transmission, Easytronic.....	100
Driving programmes.....	102
fault.....	104
Interruption of power supply.....	105
Kickdown.....	103, 104
Selector lever.....	12, 101
Winter programme.....	103
Tread depth.....	123
Trip computer.....	17, 81
Trip odometer.....	72
Triple information display.....	74
Turn signal lamps.....	9, 87
Bulb replacement.....	146
Tyre chains.....	125, 176
Tyre condition.....	123
Tyre pressure.....	122, 176
Tyre repair aerosol.....	137

**U**

Ultrasonic parking sensors.....	118
Units of measure.....	80
Unleaded fuel.....	110, 112, 170

**V**

Vauxhall alarm system.....	29
Vauxhall genuine parts	
and accessories.....	159
Vehicle care.....	150
Vehicle decommissioning.....	166
Vehicle identification number.....	169
Vehicle keys, see Keys.....	20
Vehicle recommissioning.....	167
Ventilation.....	92, 95

**W**

Warning buzzers.....	84
Warning triangle.....	130
Washer fluid reservoir,	
windscreen washer system.....	165
Weights.....	174
Windows	
Demisting and defrosting.....	96, 98
Windscreen washer system.....	11, 85, 165
Anti-freeze protection.....	165
Washer fluid reservoir.....	165
Windscreen wipers.....	10, 85, 165

**Winter operation**

Battery.....	107
Coolant, anti-freeze.....	162
Fuel consumption.....	109
Fuel for diesel engines.....	110
Heating.....	92
Locks.....	151
Tyre chains.....	125, 176
Window demisting and defrosting.....	96, 98
Windscreen washer system,	
anti-freeze protection.....	165
Winter programme.....	103
Winter tyres.....	124, 176