

INSIGNIA

PRICE/SPECIFICATION GUIDE

6 March 2018 | Model Year 2018.5



Contents:

Model Year 2018.5 (pages 2-44)

Pre-current Model Year (pages 46-74)



VAUXHALL

INSIGNIA RANGE HIGHLIGHTS



DESIGN OTR from £18,775

Standard features include:

Exterior convenience / styling:

- 17-inch bi-colour structure wheels (1.6 diesel ecoTEC models)
- 17-inch five twin-spoke alloy wheels (excluding 1.6 diesel ecoTEC models)
- Automatic lighting control
- Electrically operated front / rear windows
- Electrically adjustable / heated door mirrors

Interior convenience / styling:

- Air conditioning
- Leather-covered steering wheel
- Steering wheel audio / phone / cruise controls
- Steering column adjustable for reach / rake

Infotainment:

- IntelliLink audio system
 - 7-inch colour touchscreen
 - Bluetooth® / Apple CarPlay™ / Android Auto™
- Seven speakers (five front, two rear)

Safety / security:

- OnStar
- Electronic Stability Programme (ESP)
- Anti-lock Braking System (ABS)
- Driving Assistance Pack One
- Six airbags
- Keyless start
- Security alarm system (Thatcham approved, T1)

DESIGN NAV OTR from £19,570

Design Nav models additional feature:

- Navi 900 IntelliLink system
 - Fully integrated European sat nav system
 - 8-inch colour touchscreen

Structure wheel



Alloy wheel



SRI OTR from £21,335

Features over Design:

Exterior convenience / styling:

- 17-inch five twin-spoke alloy wheels
- Front fog lights
- Dark-tinted rear windows
- Rear spoiler (Grand Sport models)
- Rain-sensitive windscreen wipers
- Silver-effect roof rails (Sports Tourer models)
- Front and rear parking sensors

Interior convenience / styling:

- Sports front seats, driver's AGR
- Sports pedals
- Dual-zone electronic climate control
- Illuminated vanity mirrors
- Storage pockets on front seat backs
- Ambient LED lighting in front doors
- Twin rear USB sockets
- Auto-dimming rear-view mirror

SRI NAV OTR from £22,130

SRI Nav models additional feature:

- Navi 900 IntelliLink system
 - Fully integrated European sat nav system
 - 8-inch colour touchscreen



SRI VX-LINE NAV OTR from £23,350

Insignia Exclusive models are now available, see separate Price and Specification Guide for full details or contact your Vauxhall Retailer.

Features over SRI:

Exterior convenience / styling:

- 17-inch five twin-spoke alloy wheels (1.6 diesel ecoTEC models)
- 18-inch five-spoke alloy wheels (excluding 1.6 diesel ecoTEC models)
- VXR Styling Pack
 - Sports-style front and rear bumpers
 - Side sills
 - Visible exhaust tailpipe (excluding Grand Sport 1.5 (165PS) Turbo models)

Interior convenience / styling:

- Heated, flat-bottom, leather-covered VX-Line steering wheel
- Dark fabric headlining
- 4.2-inch colour information display

Infotainment:

- Navi 900 IntelliLink system
 - Fully integrated European sat nav system
 - 8-inch colour touchscreen

17-inch



18-inch



INSIGNIA RANGE HIGHLIGHTS



DESIGN OTR from £18,775

Standard features include:

Exterior convenience / styling:

- 17-inch bi-colour structure wheels (1.6 diesel ecoTEC models)
- 17-inch five twin-spoke alloy wheels (excluding 1.6 diesel ecoTEC models)
- Automatic lighting control
- Electrically operated front / rear windows
- Electrically adjustable / heated door mirrors

Interior convenience / styling:

- Air conditioning
- Leather-covered steering wheel
- Steering wheel audio / phone / cruise controls
- Steering column adjustable for reach / rake

Infotainment:

- IntelliLink audio system
 - 7-inch colour touchscreen
 - Bluetooth® / Apple CarPlay™ / Android Auto™
- Seven speakers (five front, two rear)

Safety / security:

- OnStar
- Electronic Stability Programme (ESP)
- Anti-lock Braking System (ABS)
- Driving Assistance Pack One
- Six airbags
- Keyless start
- Security alarm system (Thatcham approved, T1)

DESIGN NAV OTR from £19,570

Design Nav models additional feature:

- Navi 900 IntelliLink system
 - Fully integrated European sat nav system
 - 8-inch colour touchscreen

Structure wheel



Alloy wheel



TECH LINE NAV OTR from £21,670

Features over Design:

Exterior convenience / styling:

- 17-inch five twin-spoke alloy wheels
- Rain-sensitive windscreen wipers
- Chrome-effect inserts in door handles
- Front and rear parking sensors
- Silver-effect roof rails (Sports Tourer models)

Interior convenience / styling:

- Dual-zone electronic climate control
- Twin rear USB sockets
- Auto-dimming rear-view mirror
- 4.2-inch colour information display
- Driver's seat tilt and lumbar adjustment
- Front passenger's seat height adjustment

Infotainment:

- Navi 900 IntelliLink system
 - Fully integrated European sat nav system
 - 8-inch colour touchscreen



ELITE NAV OTR from £24,300

Insignia Exclusive models are now available, see separate Price and Specification Guide for full details or contact your Vauxhall Retailer.

Features over Tech Line Nav:

Exterior convenience / styling:

- 17-inch five twin-spoke alloy wheels (1.6 diesel ecoTEC models)
- 18-inch bi-colour alloy wheels (excluding 1.6 diesel ecoTEC, 2.0 (260PS) Turbo 4X4 and 2.0 (210PS) BiTurbo D 4X4 models)
- 20-inch five twin-spoke alloy wheels (2.0 (260PS) Turbo 4X4 and 2.0 (210PS) BiTurbo D 4X4 models)
- IntelliLux LED® matrix headlights
- Front fog lights
- Dark-tinted rear windows
- Torque vectoring system (4X4 models)

Interior convenience / styling:

- Leather seat facings
- Heated front seats
- Heated outer rear seats (Grand Sport 4X4 and all Sports Tourer models)
- 8-inch colour information display

Infotainment:

- Bose® premium sound system (2.0 (260PS) Turbo 4X4 and 2.0 (210PS) BiTurbo D 4X4 models)

17-inch



18-inch



20-inch



INSIGNIA RANGE HIGHLIGHTS



GSi NAV OTR from £32,975

Features over Tech Line Nav:

Exterior convenience / styling:

- 20-inch five twin-spoke alloy wheels
- GSi front and rear bumpers
- GSi side sills
- GSi rear spoiler (Grand Sport models)
- Visible exhaust tailpipes
- IntelliLux LED® matrix headlights
- FlexRide with Competition mode
- Sports chassis
- Dark-tinted rear windows
- Torque vectoring system

Interior convenience / styling:

- Perforated leather seat facings
- Ergonomic AGR sports front seats
- Heated front and outer rear seats
- Heated, flat-bottom, leather-covered VX-Line steering wheel
- Head-up display
- 8-inch colour information display
- Dark fabric headlining
- Sports pedals
- FlexOrganiser® Pack (Sports Tourer models)

Infotainment:

- Bose® premium sound system



COUNTRY TOURER OTR from £25,635

Standard features include:

Exterior convenience / styling:

- 18-inch bi-colour five twin-spoke alloy wheels
- Anthracite wheel arch and side sill extensions
- Front and rear bumpers incorporating silver-effect skid plates
- Silver-effect roof rails
- Front and rear parking sensors
- FlexRide
- Automatic lighting control
- Electrically operated front / rear windows
- Electrically adjustable / heated door mirrors

Interior convenience / styling:

- Dual-zone electronic climate control
- Leather-covered steering wheel
- Steering wheel audio / phone / cruise controls
- Steering column adjustable for reach / rake

Infotainment:

- Navi 900 IntelliLink system
 - Fully integrated European sat nav system
 - 8-inch colour touchscreen
 - Bluetooth® / Apple CarPlay™ / Android Auto™
- Seven speakers (five front, two rear)
- Bose® premium sound system (2.0 (210PS) BiTurbo D 4X4 models)

Safety / security:

- OnStar
- Electronic Stability Programme (ESP)
- Anti-lock Braking System (ABS)
- Driving Assistance Pack One
- Six airbags
- Keyless start
- Security alarm system (Thatcham approved, T1)



INSIGNIA DESIGN



		Grand Sport		Sports Tourer	
		OTR RRP	CO ₂ (g/km)	OTR RRP	CO ₂ (g/km)
DESIGN – ON-THE-ROAD PRICES					
Petrol	1.5 (140PS) Turbo ecoTEC	£18,775	133	£20,295	136
	1.5 (165PS) Turbo	£19,075	136	£20,595	139
	1.5 (165PS) Turbo auto	£20,675	138	£22,195	141
Diesel	1.6 (110PS) Turbo D ecoTEC	£19,075	105	£20,595	112
	1.6 (136PS) Turbo D ecoTEC	£19,595	114	£21,095	119
	1.6 (136PS) Turbo D auto	£21,235	134	–	–
	1.6 (136PS) Turbo D ecoTEC auto	–	–	£22,735	137
	2.0 (170PS) Turbo D BlueInjection	–	–	£21,935	139
	2.0 (170PS) Turbo D auto BlueInjection	–	–	£23,535	150

		Grand Sport		Sports Tourer	
		OTR RRP	CO ₂ (g/km)	OTR RRP	CO ₂ (g/km)
DESIGN NAV – ON-THE-ROAD PRICES					
Petrol	1.5 (140PS) Turbo ecoTEC	£19,570	133	£21,090	136
	1.5 (165PS) Turbo	£19,870	136	£21,390	139
	1.5 (165PS) Turbo auto	£21,470	138	£22,990	141
Diesel	1.6 (110PS) Turbo D ecoTEC	£19,870	105	£21,390	112
	1.6 (136PS) Turbo D ecoTEC	£20,390	114	£21,890	119
	1.6 (136PS) Turbo D auto	£22,030	134	–	–
	1.6 (136PS) Turbo D ecoTEC auto	–	–	£23,530	137
	2.0 (170PS) Turbo D BlueInjection	–	–	£22,730	139
	2.0 (170PS) Turbo D auto BlueInjection	–	–	£24,330	150

Please note: On-the-road recommended retail prices (RRP) include VAT at 20%, number plates and delivery to Retailer of £700.00 (inc. £116.67 VAT), 12 months' Vehicle Excise Duty and new vehicle first registration fee of £55.00. Excludes fuel and insurance.

KEY OPTIONS		Total inc. VAT
	Looking good: Brilliant paint	£285
	Metallic / pearlescent paint	£565
	Two-coat premium paint	£655
	Tri-coat premium paint	£725
	18-inch bi-colour alloy wheels	£505
	Easier parking: Front and rear parking distance sensors	£460
	Sitting comfortably: Ergonomic driver's sports-style seat	£425
	Winter Pack One Heated front seats / heated steering wheel / heated windscreen	£660
	Fresh air: Dual-zone electronic climate control	£405
	Driving assistance: Driving Assistance Pack Four Advanced park assist / lane change assist with side blind spot alert / rear-view camera / rear cross traffic alert	£650
	Practicality: 17-inch steel emergency spare wheel (in lieu of emergency tyre inflation kit)	£110
	Sight and Light Pack Automatic lighting control with tunnel detection / rain-sensitive windscreen wipers / auto-dimming rear-view mirror / high beam assist	£240

For details of these and other options please see Features/Options pages.

FEATURES

OnStar:

- Automatic crash response / Wi-Fi hotspot / smartphone app / stolen vehicle assistance / vehicle diagnostics

Infotainment:

- IntelliLink audio system
 - 7-inch colour touchscreen
 - AM/FM/DAB digital radio
 - Bluetooth® audio streaming
 - Bluetooth® mobile phone portal
 - Apple CarPlay™ / Android Auto™
 - USB audio connection
- Seven speakers (five front, two rear)

Interior convenience / styling:

- Air conditioning
- Multi-function trip computer
- Cruise control with speed limiter
- Leather-covered steering wheel
- Front centre armrest
- Steering wheel audio / phone / cruise controls
- Steering column adjustable for reach / rake

Exterior convenience / styling:

- 17-inch bi-colour structure wheels (1.6 diesel ecoTEC models)
- 17-inch five twin-spoke alloy wheels (excluding 1.6 diesel ecoTEC models)
- Automatic lighting control
- Electrically operated front / rear windows
- Electrically adjustable / heated door mirrors
- Black roof rails (Sports Tourer models)

Safety / security:

- Driving Assistance Pack One
 - Front camera system
 - Forward collision alert with automatic city emergency braking
 - Following distance indicator
 - Lane departure warning with lane assist
- Electronic Stability Programme (ESP)
- Anti-lock Braking System (ABS)
- Six airbags
- Hill start assist
- ISOFIX child seat mounting points, outer rear seats
- Tyre pressure monitoring system
- LED daytime running lights
- Keyless start
- Remote control central locking
- Security alarm system (Thatcham approved, T1)

Design Nav models additionally feature:

- Navi 900 IntelliLink system
 - Fully integrated European sat nav system
 - 8-inch colour touchscreen
- Traffic sign recognition

CUSTOMER OFFERS*

- Flexible Personal Lease
- Flexible PCP (4.2% APR)

Please consult your Retailer for details.

* = Terms and conditions apply.

COMPANY CAR INFORMATION

- P11D price starting at £18,520
- From 23% tax band**
- From £73 monthly BiK tax**
- CO₂ emissions from 105g/km

Please see www.vauxhall.co.uk/fleet for details.

** = 2017/18 tax year.

INSIGNIA SRI



		Grand Sport		Sports Tourer	
		OTR RRP	CO ₂ (g/km)	OTR RRP	CO ₂ (g/km)
SRI – ON-THE-ROAD PRICES					
Petrol	1.5 (165PS) Turbo	£21,335	136	£22,855	139
	1.5 (165PS) Turbo auto	£22,935	138	£24,455	141
Diesel	1.6 (110PS) Turbo D ecoTEC	£21,335	105	£22,855	112
	1.6 (136PS) Turbo D ecoTEC	£21,855	114	£23,355	119
	1.6 (136PS) Turbo D auto	£23,495	134	–	–
	1.6 (136PS) Turbo D ecoTEC auto	–	–	£24,995	137
	2.0 (170PS) Turbo D BlueInjection	£22,695	136	£24,195	139
	2.0 (170PS) Turbo D auto BlueInjection	£24,295	145	£25,795	150

SRI NAV – ON-THE-ROAD PRICES					
Petrol	1.5 (165PS) Turbo	£22,130	136	£23,650	139
	1.5 (165PS) Turbo auto	£23,730	138	£25,250	141
Diesel	1.6 (110PS) Turbo D ecoTEC	£22,130	105	£23,650	112
	1.6 (136PS) Turbo D ecoTEC	£22,650	114	£24,150	119
	1.6 (136PS) Turbo D auto	£24,290	134	–	–
	1.6 (136PS) Turbo D ecoTEC auto	–	–	£25,790	137
	2.0 (170PS) Turbo D BlueInjection	£23,490	136	£24,990	139
	2.0 (170PS) Turbo D auto BlueInjection	£25,090	145	£26,590	150

Please note: On-the-road recommended retail prices (RRP) include VAT at 20%, number plates and delivery to Retailer of £700.00 (inc. £116.67 VAT), 12 months' Vehicle Excise Duty and new vehicle first registration fee of £55.00. Excludes fuel and insurance.

KEY OPTIONS		Total inc. VAT
	Looking good:	
	Brilliant paint	£285
	Metallic / pearlescent paint	£565
	Two-coat premium paint	£655
	Tri-coat premium paint	£725
	18-inch bi-colour alloy wheels	£505
	20-inch five twin-spoke alloy wheels	£995
	VXR Styling Pack	£850
	<i>Sports-style bumpers / side sills / visible exhaust tailpipe</i>	
	Sitting comfortably:	£1155
	Leather-covered ergonomic sports-style front seats	
	Winter Pack One	£660
	<i>Heated front seats / heated steering wheel / heated windscreen</i>	
	Fresh air:	£705
	Power tilt and slide glass sunroof (Grand Sport models)	
	Panoramic glass sunroof; power tilt and slide front, fixed panoramic rear section (Sports Tourer models)	£960
		Driving assistance:
Driving Assistance Pack Four		£650
<i>Advanced park assist / lane change assist with side blind spot alert / rear-view camera / rear cross traffic alert</i>		
	IntelliLux LED® matrix headlights	£1295
	Practicality:	£110
	17-inch steel emergency spare wheel (in lieu of tyre inflation kit)	

For details of these and other options please see Features/Options pages.

FEATURES

OnStar:

- Automatic crash response / Wi-Fi hotspot / smartphone app / stolen vehicle assistance / vehicle diagnostics

Infotainment:

- IntelliLink audio system
 - 7-inch colour touchscreen
 - AM/FM/DAB digital radio
 - Bluetooth® audio streaming
 - Bluetooth® mobile phone portal
 - Apple CarPlay™ / Android Auto™
 - USB audio connection
- Seven speakers (five front, two rear)

Interior convenience / styling:

- Sports front seats, driver's AGR
- Dual-zone electronic climate control
- Multi-function trip computer
- Cruise control with speed limiter
- Leather-covered steering wheel
- Front centre armrest
- Steering wheel audio / phone / cruise controls
- Steering column adjustable for reach / rake
- Sports pedals
- Twin rear USB sockets
- Auto-dimming rear-view mirror
- Illuminated vanity mirrors
- Storage pockets on front seat backs
- Ambient LED lighting in front doors

Exterior convenience / styling:

- 17-inch five twin-spoke alloy wheels
- Front fog lights
- Automatic lighting control with tunnel detection
- Dark-tinted rear windows
- Rain-sensitive windscreen wipers
- Electrically adjustable / heated door mirrors
- Rear spoiler (Grand Sport models)
- Front and rear parking sensors
- Silver-effect roof rails (Sports Tourer models)

Safety / security:

- Driving Assistance Pack One
 - Front camera system
 - Forward collision alert with automatic city emergency braking
 - Following distance indicator
 - Lane departure warning with lane assist
- Electronic Stability Programme (ESP)
- Anti-lock Braking System (ABS)
- Six airbags
- ISOFIX child seat mounting points, outer rear seats
- Tyre pressure monitoring system
- LED daytime running lights
- Security alarm system (Thatcham approved, T1)

SRI Nav models additionally feature:

- Navi 900 IntelliLink system
 - Fully integrated European sat nav system
 - 8-inch colour touchscreen
- Traffic sign recognition

CUSTOMER OFFERS*

- Flexible Personal Lease
- Flexible PCP (4.2% APR)

Please consult your Retailer for details.

* = Terms and conditions apply.

COMPANY CAR INFORMATION

- P11D price starting at £21,080
- From 23% tax band**
- From £82 monthly BiK tax**
- CO₂ emissions from 105g/km

Please see www.vauxhall.co.uk/fleet for details.

** = 2017/18 tax year.

INSIGNIA SRi VX-LINE NAV

	Grand Sport		Sports Tourer		
	OTR RRP	CO ₂ (g/km)	OTR RRP	CO ₂ (g/km)	
SRi VX-LINE NAV – ON-THE-ROAD PRICES					
<i>Petrol</i>	1.5 (165PS) Turbo	£23,350	136	£24,870	139
	1.5 (165PS) Turbo auto	£24,950	138	£26,470	141
<i>Diesel</i>	1.6 (136PS) Turbo D ecoTEC*	£23,870	114	£25,370	119
	1.6 (136PS) Turbo D auto	£25,510	134	–	–
	1.6 (136PS) Turbo D ecoTEC auto	–	–	£27,010	137
	2.0 (170PS) Turbo D BluInjection	£24,710	136	£26,210	139
	2.0 (170PS) Turbo D auto BluInjection	£26,310	145	£27,810	150

Please note: On-the-road recommended retail prices (RRP) include VAT at 20%, number plates and delivery to Retailer of £700.00 (inc. £116.67 VAT), 12 months' Vehicle Excise Duty and new vehicle first registration fee of £55.00. Excludes fuel and insurance.
* = Fitted with 17-inch alloy wheels.



FEATURES

OnStar:

- Automatic crash response / Wi-Fi hotspot / smartphone app / stolen vehicle assistance / vehicle diagnostics

Infotainment:

- Navi 900 IntelliLink system
 - Fully integrated European sat nav system
 - 8-inch colour touchscreen
 - AM/FM/DAB digital radio
 - Bluetooth® audio streaming
 - Bluetooth® mobile phone portal
 - Apple CarPlay™ / Android Auto™
 - USB audio connection
- Seven speakers (five front, two rear)

Interior convenience / styling:

- Sports front seats, driver's AGR
- Dual-zone electronic climate control
- Multi-function trip computer
- Cruise control with speed limiter
- Steering wheel audio / phone / cruise controls
- Heated, flat bottom, leather-covered VX-Line steering wheel
- Steering column adjustable for reach / rake
- Sports pedals
- Dark fabric headlining
- 4.2-inch colour information display
- Twin rear USB sockets
- Auto-dimming rear-view mirror

Exterior convenience / styling:





- 17-inch alloy wheels (1.6 diesel ecoTEC models)
- 18-inch alloy wheels (excluding 1.6 diesel ecoTEC models)
- VXR Styling Pack
 - Sports-style front and rear bumpers
 - Side sills
 - Visible exhaust tailpipe (excluding Grand Sport 1.5 (165PS) Turbo models)
 - Rear spoiler (Grand Sport models)
- Chrome-effect upper window trim
- Automatic lighting control with tunnel detection
- Electrically operated front / rear windows
- Electrically adjustable / heated door mirrors
- Front and rear parking sensors
- Silver-effect roof rails (Sports Tourer models)

Safety / security:

- Driving Assistance Pack One
 - Front camera system
 - Forward collision alert with automatic city emergency braking
 - Following distance indicator
 - Lane departure warning with lane assist
 - Traffic sign recognition
- Electronic Stability Programme (ESP)
- Anti-lock Braking System (ABS)
- Six airbags
- ISOFIX child seat mounting points, outer rear seats
- Tyre pressure monitoring system
- LED daytime running lights
- Remote control central locking
- Security alarm system (Thatcham approved, T1)



Insignia Exclusive models are now available, see separate Price and Specification Guide for full details or contact your Vauxhall Retailer.



KEY OPTIONS		Total inc. VAT
	Looking good: Brilliant paint	£285
	Metallic / pearlescent paint	£565
	Two-coat premium paint	£655
	Tri-coat premium paint	£725
	20-inch five twin-spoke alloy wheels	£880
	Sitting comfortably: Leather-covered ergonomic sports-style front seats	£1155
	Winter Pack Four <i>Heated front seats / heated windscreen</i>	£410
	Fresh air: Power tilt and slide glass sunroof (Grand Sport models)	£705
	Panoramic glass sunroof; power tilt and slide front, fixed panoramic rear section (Sports Tourer models)	£960
	Driving assistance: Driving Assistance Pack Four <i>Advanced park assist / lane change assist with side blind spot alert / rear-view camera / rear cross traffic alert</i>	£650
	Head-up display	£290
	IntelliLux LED® matrix headlights	£1295
	Practicality: 17-inch steel emergency spare wheel (in lieu of emergency tyre inflation kit)	£110
	Wireless charger for mobile devices	£160
	FlexOrganiser® Pack (Sports Tourer models)	£120
	Power tailgate (Sports Tourer models)	£680
	Towing Pack	£685

For details of these and other options please see Features/Options pages.





CUSTOMER OFFERS*

-  Flexible Personal Lease
-  Flexible PCP (4.2% APR)

Please consult your Retailer for details.

* = Terms and conditions apply.

COMPANY CAR INFORMATION

-  P11D price starting at £23,095
-  From 24% tax band**
-  From £95 monthly BiK tax**
-  CO₂ emissions from 114g/km





Please see www.vauxhall.co.uk/fleet for details.

** = 2017/18 tax year.

INSIGNIA TECH LINE NAV

		Grand Sport		Sports Tourer	
		OTR RRP	CO ₂ (g/km)	OTR RRP	CO ₂ (g/km)
TECH LINE NAV – ON-THE-ROAD PRICES					
<i>Petrol</i>	1.5 (165PS) Turbo	£21,670	136	£23,190	139
	1.5 (165PS) Turbo auto	£23,270	138	£24,790	141
<i>Diesel</i>	1.6 (110PS) Turbo D ecoTEC	£21,670	105	£23,190	112
	1.6 (136PS) Turbo D ecoTEC	£22,190	114	£23,690	119
	1.6 (136PS) Turbo D auto	£23,830	134	–	–
	1.6 (136PS) Turbo D ecoTEC auto	–	–	£25,330	137
	2.0 (170PS) Turbo D BlueInjection	£23,030	136	£24,530	139
	2.0 (170PS) Turbo D auto BlueInjection	£24,630	145	£26,130	150

Please note: On-the-road recommended retail prices (RRP) include VAT at 20%, number plates and delivery to Retailer of £700.00 (inc. £116.67 VAT), 12 months' Vehicle Excise Duty and new vehicle first registration fee of £55.00. Excludes fuel and insurance.

KEY OPTIONS		Total inc. VAT
 Looking good:	Brilliant paint	£285
	Metallic / pearlescent paint	£565
	Two-coat premium paint	£655
	Tri-coat premium paint	£725
	18-inch bi-colour alloy wheels	£505
	20-inch five twin-spoke alloy wheels	£995
 Sitting comfortably:	Leather-covered ergonomic sports-style front seats	£1155
	Winter Pack One <i>Heated front seats / heated steering wheel / heated windscreen</i>	£660
 Fresh air:	Power tilt and slide glass sunroof (Grand Sport models)	£705
	Panoramic glass sunroof; power tilt and slide front, fixed panoramic rear section (Sports Tourer models)	£960
 Driving assistance:	Driving Assistance Pack Two <i>Automatic cruise control / automatic brake intervention</i>	£570
	Driving Assistance Pack Four <i>Advanced park assist / lane change assist with side blind spot alert / rear-view camera / rear cross traffic alert</i>	£650
	Head-up display	£290
	IntelliLux LED® matrix headlights	£1295
	 Practicality:	17-inch steel emergency spare wheel (in lieu of emergency tyre inflation kit)
Wireless charger for mobile devices		£160
FlexOrganiser® Pack (Sports Tourer models)		£120
Power tailgate (Sports Tourer models)		£680
Towing Pack		£685

For details of these and other options please see Features/Options pages.



FEATURES

OnStar:

- Automatic crash response / Wi-Fi hotspot / smartphone app / stolen vehicle assistance / vehicle diagnostics

Infotainment:

- Navi 900 IntelliLink system
 - Fully integrated European sat nav system
 - 8-inch colour touchscreen
 - AM/FM/DAB digital radio
 - Bluetooth® audio streaming
 - Bluetooth® mobile phone portal
 - Apple CarPlay™ / Android Auto™
 - USB audio connection
- Seven speakers (five front, two rear)

Interior convenience / styling:

- Dual-zone electronic climate control
- Multi-function trip computer
- 16-way adjustable driver's seat
- Front centre armrest
- Storage pockets on front seat backs
- Cruise control with speed limiter
- Leather-covered steering wheel
- Steering wheel audio / phone / cruise controls
- Steering column adjustable for reach / rake
- 4.2-inch colour information display
- Twin rear USB sockets
- Auto-dimming rear-view mirror



Exterior convenience / styling:

- 17-inch five twin-spoke alloy wheels
- Chrome-effect upper window trim
- Chrome-effect inserts in door handles
- Rain-sensitive windscreen wipers
- Automatic lighting control with tunnel detection
- Electrically adjustable/heated door mirrors
- Front and rear parking sensors
- Silver-effect roof rails (Sports Tourer models)

Safety / security:

- Driving Assistance Pack One
 - Front camera system
 - Forward collision alert with automatic city emergency braking
 - Following distance indicator
 - Lane departure warning with lane assist
 - Traffic sign recognition
- Electronic Stability Programme (ESP)
- Anti-lock Braking System (ABS)
- Six airbags
- Hill start assist
- ISOFIX child seat mounting points, outer rear seats
- Tyre pressure monitoring system
- LED daytime running lights
- Security alarm system (Thatcham approved, T1)
- Electronic engine deadlock immobiliser

CUSTOMER OFFERS*

-  Flexible Personal Lease
-  Flexible PCP (4.2% APR)

Please consult your Retailer for details.

* = Terms and conditions apply.

COMPANY CAR INFORMATION

-  P11D price starting at £21,415
-  From 23% tax band**
-  From £83 monthly BiK tax**
-  CO₂ emissions from 105g/km

Please see www.vauxhall.co.uk/fleet for details.

** = 2017/18 tax year.

INSIGNIA ELITE NAV

		Grand Sport		Sports Tourer	
		OTR RRP	CO ₂ (g/km)	OTR RRP	CO ₂ (g/km)
ELITE NAV – ON-THE-ROAD PRICES					
Petrol	1.5 (165PS) Turbo	£24,300	136	£25,820	139
	1.5 (165PS) Turbo auto	£25,900	138	£27,420	141
	2.0 (260PS) Turbo 4X4 auto	£28,860	197	£30,360	199
Diesel	1.6 (110PS) Turbo D ecoTEC*	£24,300	105	£25,820	112
	1.6 (136PS) Turbo D ecoTEC*	£24,820	114	£26,320	119
	1.6 (136PS) Turbo D auto	£26,460	134	–	–
	1.6 (136PS) Turbo D ecoTEC auto	–	–	£27,960	137
	2.0 (170PS) Turbo D BlueInjection	£25,660	136	£27,160	139
	2.0 (170PS) Turbo D auto BlueInjection	£27,260	145	£28,760	150
	2.0 (210PS) BiTurbo D 4X4 auto BlueInjection	£28,460	183	£29,960	186

Please note: On-the-road recommended retail prices (RRP) include VAT at 20%, number plates and delivery to Retailer of £700.00 (inc. £116.67 VAT), 12 months' Vehicle Excise Duty and new vehicle first registration fee of £55.00. Excludes fuel and insurance.
* = Fitted with 17-inch alloy wheels.

Insignia Exclusive models are now available, see separate Price and Specification Guide for full details or contact your Vauxhall Retailer.



KEY OPTIONS		Total inc. VAT
	Looking good: Brilliant paint	£285
	Metallic / pearlescent paint	£565
	Two-coat premium paint	£655
	Tri-coat premium paint	£725
	20-inch five twin-spoke alloy wheels	£880
	Sitting comfortably: Winter Pack Two	£400
	Heated steering wheel / heated windscreen	
	Fresh air: Power tilt and slide glass sunroof (Grand Sport models)	£705
	Panoramic glass sunroof; power tilt and slide front, fixed panoramic rear section (Sports Tourer models)	£960
	Driving assistance: Driving Assistance Pack Two	£570
	Automatic cruise control / automatic brake intervention	
	Driving Assistance Pack Four	£650
	Advanced park assist / lane change assist with side blind spot alert / rear-view camera / rear cross traffic alert	
	Head-up display	£290
	Practicality: 17-inch steel emergency spare wheel (in lieu of emergency tyre inflation kit)	£110
	Wireless charger for mobile devices	£160
	FlexOrganiser® Pack (Sports Tourer models)	£120
	Power tailgate (Sports Tourer models)	£680
Towing Pack	£685	

For details of these and other options please see Features/Options pages.



FEATURES

OnStar:

- Automatic crash response / Wi-Fi hotspot / smartphone app / stolen vehicle assistance / vehicle diagnostics

Infotainment:

- Navi 900 IntelliLink system
 - Fully integrated European sat nav system
 - 8-inch colour touchscreen
 - AM/FM/DAB digital radio
 - Bluetooth® audio streaming
 - Bluetooth® mobile phone portal
 - Apple CarPlay™ / Android Auto™
 - USB audio connection
- Seven speakers (five front, two rear)
- Bose® premium sound system (2.0 (260PS) Turbo 4X4 and 2.0 (210PS) BiTurbo D 4X4 models only)

Interior convenience / styling:

- Leather seat facings
- Dual-zone electronic climate control
- Leather-covered steering wheel
- Heated front seats
- 16-way adjustable driver's seat
- Multi-function trip computer
- Cruise control with speed limiter
- Front centre armrest
- Steering wheel audio / phone / cruise controls
- 8-inch colour information display
- Twin rear USB sockets

Exterior convenience / styling:

- 17-inch alloy wheels (1.6 diesel ecoTEC models)
- 18-inch alloy wheels (excluding 1.6 diesel ecoTEC, 2.0 (260PS) Turbo 4X4 and 2.0 (210PS) BiTurbo D 4X4 models)
- 20-inch alloy wheels (2.0 (260PS) Turbo 4X4 and 2.0 (210PS) BiTurbo D 4X4 models)
- IntelliLux LED® matrix headlights
- Rain-sensitive windscreen wipers
- Automatic lighting control with tunnel detection
- Front fog lights
- Dark-tinted rear windows
- Front and rear parking sensors
- Silver-effect roof rails (Sports Tourer models)

Safety / security:

- Driving Assistance Pack One
 - Front camera system
 - Forward collision alert with automatic city emergency braking
 - Following distance indicator
 - Lane departure warning with lane assist
 - Traffic sign recognition
- Electronic Stability Programme (ESP)
- Anti-lock Braking System (ABS)
- Six airbags
- Hill start assist
- ISOFIX child seat mounting points, outer rear seats
- Tyre pressure monitoring system
- Security alarm system (Thatcham approved, T1)

CUSTOMER OFFERS*

- Flexible Personal Lease
- Flexible PCP (4.2% APR)

Please consult your Retailer for details.

* = Terms and conditions apply.

COMPANY CAR INFORMATION

- P11D price starting at £24,045
- From 23% tax band**
- From £93 monthly BiK tax**
- CO₂ emissions from 105g/km





Please see www.vauxhall.co.uk/fleet for details.

** = 2017/18 tax year.

INSIGNIA GSi NAV

	Grand Sport		Sports Tourer	
	OTR RRP	CO ₂ (g/km)	OTR RRP	CO ₂ (g/km)
GSi NAV – ON-THE-ROAD PRICES				
<i>Petrol</i> 2.0 (260PS) Turbo 4X4 auto	£33,375	197	£34,875	199
<i>Diesel</i> 2.0 (210PS) BiTurbo D 4X4 auto BlueInjection	£32,975	186	£34,475	187

Please note: On-the-road recommended retail prices (RRP) include VAT at 20%, number plates and delivery to Retailer of £700.00 (inc. £116.67 VAT), 12 months' Vehicle Excise Duty and new vehicle first registration fee of £55.00. Excludes fuel and insurance.

KEY OPTIONS		Total inc. VAT
 Looking good:	Lava Red brilliant paint	£285
	Metallic / pearlescent paint	£565
	Two-coat premium paint	£655
	Tri-coat premium paint	£725
 Sitting comfortably:	Winter Pack Three	£150
	Heated windscreen	
 Fresh air:	Power tilt and slide glass sunroof (Grand Sport models)	£705
	Panoramic glass sunroof; power tilt and slide front, fixed panoramic rear section (Sports Tourer models)	£960
 Driving assistance:	Driving Assistance Pack Two	£570
	Automatic cruise control / automatic brake intervention	
 Practicality:	Wireless charger for mobile devices	£160
	Power tailgate (Sports Tourer models)	£380

For details of these and other options please see Features/Options pages.



FEATURES

OnStar:

- Automatic crash response / Wi-Fi hotspot / smartphone app / stolen vehicle assistance / vehicle diagnostics

Infotainment:

- Navi 900 IntelliLink system
 - Fully integrated European sat nav system
 - 8-inch colour touchscreen
 - AM/FM/DAB digital radio
 - Bluetooth® audio streaming
 - Bluetooth® mobile phone portal
 - Apple CarPlay™ / Android Auto™
 - USB audio connection
- Bose® premium sound system

Interior convenience / styling:

- Perforated leather seat facings
- Ergonomic AGR sports front seats
- Dual-zone electronic climate control
- Heated, flat-bottom leather-covered VX-Line steering wheel
- Heated front and outer rear seats
- Multi-function trip computer
- Cruise control with speed limiter
- Front centre armrest
- Steering wheel audio / phone / cruise controls
- Head-up display
- 8-inch colour information display
- Twin rear USB sockets
- FlexOrganiser® Pack (Sports Tourer models)



Exterior convenience / styling:

- 20-inch alloy wheels
- GSi front and rear bumpers
- GSi side sills
- GSi rear spoiler (Grand Sport models)
- Visible exhaust tailpipes
- IntelliLux LED® matrix headlights
- FlexRide with Competition mode
- Sports chassis
- Rain-sensitive windscreen wipers
- Automatic lighting control with tunnel detection
- Dark-tinted rear windows
- Front and rear parking sensors
- Silver-effect roof rails (Sports Tourer models)

Safety / security:

- Driving Assistance Pack One
 - Front camera system
 - Forward collision alert with automatic city emergency braking
 - Following distance indicator
 - Lane departure warning with lane assist
 - Traffic sign recognition
- Electronic Stability Programme (ESP)
- Anti-lock Braking System (ABS)
- Six airbags
- Hill start assist
- Tyre pressure monitoring system
- Keyless entry and start
- Security alarm system (Thatcham approved, T1)





CUSTOMER OFFERS*

-  Flexible Personal Lease
-  Flexible PCP (4.2% APR)

Please consult your Retailer for details.

* = Terms and conditions apply.

COMPANY CAR INFORMATION

-  P11D price starting at £32,120
-  From 37% tax band**
-  From £199 monthly BiK tax**
-  CO₂ emissions from 186g/km

Please see www.vauxhall.co.uk/fleet for details.

** = 2017/18 tax year.





INSIGNIA COUNTRY TOURER

Country Tourer
OTR RRP CO₂ (g/km)

COUNTRY TOURER – ON-THE-ROAD PRICES

Diesel	Engine	OTR RRP	CO ₂ (g/km)
2.0 (170PS)	Turbo D BlueInjection	£25,635	145
2.0 (170PS)	Turbo D auto BlueInjection	£27,535	157
2.0 (170PS)	Turbo D 4X4 BlueInjection	£27,235	172
2.0 (210PS)	BiTurbo D 4X4 auto BlueInjection	£28,435	188

Please note: On-the-road recommended retail prices (RRP) include VAT at 20%, number plates and delivery to Retailer of £700.00 (inc. £116.67 VAT), 12 months' Vehicle Excise Duty and new vehicle first registration fee of £55.00. Excludes fuel and insurance.

KEY OPTIONS	Total inc. VAT	
 Looking good:	Brilliant paint	£285
	Metallic / pearlescent paint	£565
	Two-coat premium paint	£655
	Tri-coat premium paint	£725
 Sitting comfortably:	Leather-covered ergonomic sports-style front seats	£1155
	Winter Pack One <i>Heated front seats / heated steering wheel / heated windscreen</i>	£660
 Fresh air:	Panoramic glass sunroof; power tilt and slide front, fixed panoramic rear section	£960
 Driving assistance:	Driving Assistance Pack Two <i>Automatic cruise control / automatic brake intervention</i>	£570
	Driving Assistance Pack Four <i>Advanced park assist / lane change assist with side blind spot alert / rear-view camera / rear cross traffic alert</i>	£650
	Head-up display	£290
	IntelliLux LED® matrix headlights	£1295
 Practicality:	17-inch steel emergency spare wheel (in lieu of emergency tyre inflation kit)	£110
	Wireless charger for mobile devices	£160
	FlexOrganiser® Pack	£120
	Power tailgate	£680
	Towing Pack	£685

For details of these and other options please see Features/Options pages.



FEATURES

OnStar:

- Automatic crash response / Wi-Fi hotspot / smartphone app / stolen vehicle assistance / vehicle diagnostics

Infotainment:

- Navi 900 IntelliLink system
 - Fully integrated European sat nav system
 - 8-inch colour touchscreen
 - AM/FM/DAB digital radio
 - Bluetooth® audio streaming
 - Bluetooth® mobile phone portal
 - Apple CarPlay™ / Android Auto™
 - USB audio connection
- Seven speakers (five front, two rear)
- Bose® premium sound system (2.0 (210PS) BiTurbo D 4X4 models)

Interior convenience / styling:

- Dual-zone electronic climate control
- Leather-covered steering wheel
- 16-way adjustable driver's seat
- Multi-function trip computer
- Cruise control with speed limiter
- Front centre armrest
- Steering wheel audio / phone / cruise controls
- 4.2-inch colour information display
- Twin rear USB sockets

Exterior convenience / styling:

- 18-inch alloy wheels
- Anthracite wheel arch and side sill extensions
- Front and rear bumpers incorporating silver-effect skid plates
- FlexRide
- Rain-sensitive windscreen wipers
- Automatic lighting control with tunnel detection
- Front fog lights
- Dark-tinted rear windows
- Electrically adjustable / heated door mirrors
- Front and rear parking sensors
- Silver-effect roof rails

Safety / security:

- Driving Assistance Pack One
 - Front camera system
 - Forward collision alert with automatic city emergency braking
 - Following distance indicator
 - Lane departure warning with lane assist
 - Traffic sign recognition
- Electronic Stability Programme (ESP)
- Anti-lock Braking System (ABS)
- Six airbags
- Hill start assist
- ISOFIX child seat mounting points, outer rear seats
- Tyre pressure monitoring system
- Security alarm system (Thatcham approved, T1)

COMPANY CAR INFORMATION

- ✓ P11D price starting at £25,380
- ✓ From 31% tax band**
- ✓ From £132 monthly BiK tax**
- ✓ CO₂ emissions from 145g/km

Please see www.vauxhall.co.uk/fleet for details.

** = 2017/18 tax year.

INSIGNIA PRICES

Model	Price (£)	VAT (£)	Total (£)	On-the-road RRP (£)	CO ₂ (g/km)	Model	Price (£)	VAT (£)	Total (£)	On-the-road RRP (£)	CO ₂ (g/km)
Grand Sport						Grand Sport					
DESIGN						SRI VX-LINE NAV					
1.5 (140PS) Turbo ecoTEC	14850.00	2970.00	17820.00	18775.00	133	1.5 (165PS) Turbo	18662.50	3732.50	22395.00	23350.00	136
1.5 (165PS) Turbo	15100.00	3020.00	18120.00	19075.00	136	1.5 (165PS) Turbo auto	19995.83	3999.17	23995.00	24950.00	138
1.5 (165PS) Turbo auto	16433.33	3286.67	19720.00	20675.00	138	<i>Diesel</i>					
<i>Diesel</i>						1.6 (136PS) Turbo D ecoTEC**	19129.16	3825.84	22955.00	23870.00	114
1.6 (110PS) Turbo D ecoTEC	15150.00	3030.00	18180.00	19075.00	105	1.6 (136PS) Turbo D auto	20462.50	4092.50	24555.00	25510.00	134
1.6 (136PS) Turbo D ecoTEC	15566.66	3113.34	18680.00	19595.00	114	2.0 (170PS) Turbo D BlueInjection*	19795.83	3959.17	23755.00	24710.00	136
1.6 (136PS) Turbo D auto	16900.00	3380.00	20280.00	21235.00	134	2.0 (170PS) Turbo D auto BlueInjection*	21129.16	4225.84	25355.00	26310.00	145
DESIGN NAV						TECH LINE NAV					
1.5 (140PS) Turbo ecoTEC	15512.50	3102.50	18615.00	19570.00	133	1.5 (165PS) Turbo	17262.50	3452.50	20715.00	21670.00	136
1.5 (165PS) Turbo	15762.50	3152.50	18915.00	19870.00	136	1.5 (165PS) Turbo auto	18595.83	3719.17	22315.00	23270.00	138
1.5 (165PS) Turbo auto	17095.83	3419.17	20515.00	21470.00	138	<i>Diesel</i>					
<i>Diesel</i>						1.6 (110PS) Turbo D ecoTEC	17312.50	3462.50	20775.00	21670.00	105
1.6 (110PS) Turbo D ecoTEC	15812.50	3162.50	18975.00	19870.00	105	1.6 (136PS) Turbo D ecoTEC	17729.16	3545.84	21275.00	22190.00	114
1.6 (136PS) Turbo D ecoTEC	16229.16	3245.84	19475.00	20390.00	114	1.6 (136PS) Turbo D auto	19062.50	3812.50	22875.00	23830.00	134
1.6 (136PS) Turbo D auto	17562.50	3512.50	21075.00	22030.00	134	2.0 (170PS) Turbo D BlueInjection*	18395.83	3679.17	22075.00	23030.00	136
SRI						ELITE NAV					
1.5 (165PS) Turbo	16983.33	3396.67	20380.00	21335.00	136	1.5 (165PS) Turbo	19454.16	3890.84	23345.00	24300.00	136
1.5 (165PS) Turbo auto	18316.66	3663.34	21980.00	22935.00	138	1.5 (165PS) Turbo auto	20787.50	4157.50	24945.00	25900.00	138
<i>Diesel</i>						2.0 (260PS) Turbo 4X4 auto	22420.83	4484.17	26905.00	28860.00	197
1.6 (110PS) Turbo D ecoTEC	17033.33	3406.67	20440.00	21335.00	105	<i>Diesel</i>					
1.6 (136PS) Turbo D ecoTEC	17450.00	3490.00	20940.00	21855.00	114	1.6 (110PS) Turbo D ecoTEC**	19504.16	3900.84	23405.00	24300.00	105
1.6 (136PS) Turbo D auto	18783.33	3756.67	22540.00	23495.00	134	1.6 (136PS) Turbo D ecoTEC**	19920.83	3984.17	23905.00	24820.00	114
2.0 (170PS) Turbo D BlueInjection*	18116.66	3623.34	21740.00	22695.00	136	1.6 (136PS) Turbo D auto	21254.16	4250.84	25505.00	26460.00	134
2.0 (170PS) Turbo D auto BlueInjection*	19450.00	3890.00	23340.00	24295.00	145	2.0 (170PS) Turbo D BlueInjection*	20587.50	4117.50	24705.00	25660.00	136
SRI NAV						GSI NAV					
1.5 (165PS) Turbo	17645.83	3529.17	21175.00	22130.00	136	2.0 (170PS) Turbo D auto BlueInjection*	21920.83	4384.17	26305.00	27260.00	145
1.5 (165PS) Turbo auto	18979.16	3795.84	22775.00	23730.00	138	2.0 (210PS) BiTurbo D 4X4 auto BlueInjection*	22420.83	4484.17	26905.00	28460.00	183
<i>Diesel</i>						2.0 (260PS) Turbo 4X4 auto	26183.33	5236.67	31420.00	33375.00	197
1.6 (110PS) Turbo D ecoTEC	17695.83	3539.17	21235.00	22130.00	105	<i>Diesel</i>					
1.6 (136PS) Turbo D ecoTEC	18112.50	3622.50	21735.00	22650.00	114	2.0 (210PS) BiTurbo D 4X4 auto BlueInjection*	26183.33	5236.67	31420.00	32975.00	186
1.6 (136PS) Turbo D auto	19445.83	3889.17	23335.00	24290.00	134	Please note: On-the-road recommended retail prices (RRP) include number plates and delivery to Retailer of £700.00 (inc. £116.67 VAT) 12 months' Vehicle Excise Duty and new vehicle first registration fee of £55.00. Excludes fuel and insurance.					
2.0 (170PS) Turbo D BlueInjection*	18779.16	3755.84	22535.00	23490.00	136	* = Please note: Vehicles with BlueInjection technology will need regular AdBlue® top-ups also between servicing requirements.					
2.0 (170PS) Turbo D auto BlueInjection*	20112.50	4022.50	24135.00	25090.00	145	An indicator integrated into the on-board computer will warn you when you need to top up. More information under www.vauxhall.co.uk/discover-vauxhall/technology/adblue.html					

Please note: On-the-road recommended retail prices (RRP) include number plates and delivery to Retailer of £700.00 (inc. £116.67 VAT) 12 months' Vehicle Excise Duty and new vehicle first registration fee of £55.00. Excludes fuel and insurance.

* = Please note: Vehicles with BlueInjection technology will need regular AdBlue® top-ups also between servicing requirements.

An indicator integrated into the on-board computer will warn you when you need to top up. More information under www.vauxhall.co.uk/discover-vauxhall/technology/adblue.html

In accordance with regulations R (EC) No. 715/2007 and R (EC) No. 692/2008 (in the versions respectively applicable).

** = Fitted with 17-inch alloy wheels. Optional alloy wheels are not available.

INSIGNIA PRICES

Model	Price (£)	VAT (£)	Total (£)	On-the-road RRP (£)	CO ₂ (g/km)	Model	Price (£)	VAT (£)	Total (£)	On-the-road RRP (£)	CO ₂ (g/km)
Sports Tourer						Sports Tourer					
DESIGN						SRI VX-LINE NAV					
1.5 (140PS) Turbo ecoTEC	16116.66	3223.34	19340.00	20295.00	136	1.5 (165PS) Turbo	19929.16	3985.84	23915.00	24870.00	139
1.5 (165PS) Turbo	16366.66	3273.34	19640.00	20595.00	139	1.5 (165PS) Turbo auto	21262.50	4252.50	25515.00	26470.00	141
1.5 (165PS) Turbo auto	17700.00	3540.00	21240.00	22195.00	141	<i>Diesel</i>					
<i>Diesel</i>						1.6 (136PS) Turbo D ecoTEC**	20379.16	4075.84	24455.00	25370.00	119
1.6 (110PS) Turbo D ecoTEC	16400.00	3280.00	19680.00	20595.00	112	1.6 (136PS) Turbo D ecoTEC auto**	21712.50	4342.50	26055.00	27010.00	137
1.6 (136PS) Turbo D ecoTEC	16816.66	3363.34	20180.00	21095.00	119	2.0 (170PS) Turbo D BlueInjection*	21045.83	4209.17	25255.00	26210.00	139
1.6 (136PS) Turbo D ecoTEC auto	18150.00	3630.00	21780.00	22735.00	137	2.0 (170PS) Turbo D auto BlueInjection*	22379.16	4475.84	26855.00	27810.00	150
2.0 (170PS) Turbo D BlueInjection*	17483.33	3496.67	20980.00	21935.00	139	TECH LINE NAV					
2.0 (170PS) Turbo D auto BlueInjection*	18816.66	3763.34	22580.00	23535.00	150	1.5 (165PS) Turbo	18529.16	3705.84	22235.00	23190.00	139
DESIGN NAV						1.5 (165PS) Turbo auto	19862.50	3972.50	23835.00	24790.00	141
1.5 (140PS) Turbo ecoTEC	16779.16	3355.84	20135.00	21090.00	136	<i>Diesel</i>					
1.5 (165PS) Turbo	17029.16	3405.84	20435.00	21390.00	139	1.6 (110PS) Turbo D ecoTEC	18562.50	3712.50	22275.00	23190.00	112
1.5 (165PS) Turbo auto	18362.50	3672.50	22035.00	22990.00	141	1.6 (136PS) Turbo D ecoTEC	18979.17	3795.83	22775.00	23690.00	119
<i>Diesel</i>						1.6 (136PS) Turbo D ecoTEC auto	20312.50	4062.50	24375.00	25330.00	137
1.6 (110PS) Turbo D ecoTEC	17062.50	3412.50	20475.00	21390.00	112	2.0 (170PS) Turbo D BlueInjection*	19645.83	3929.17	23575.00	24530.00	139
1.6 (136PS) Turbo D ecoTEC	17479.16	3495.84	20975.00	21890.00	119	2.0 (170PS) Turbo D auto BlueInjection*	20979.16	4195.84	25175.00	26130.00	150
1.6 (136PS) Turbo D ecoTEC auto	18812.50	3762.50	22575.00	23530.00	137	ELITE NAV					
2.0 (170PS) Turbo D BlueInjection*	18145.83	3629.17	21775.00	22730.00	139	1.5 (165PS) Turbo	20720.83	4144.17	24865.00	25820.00	139
2.0 (170PS) Turbo D auto BlueInjection*	19479.16	3895.84	23375.00	24330.00	150	1.5 (165PS) Turbo auto	22054.16	4410.84	26465.00	27420.00	141
SRI						2.0 (260PS) Turbo 4X4 auto	23670.83	4734.17	28405.00	30360.00	199
1.5 (165PS) Turbo	18250.00	3650.00	21900.00	22855.00	139	<i>Diesel</i>					
1.5 (165PS) Turbo auto	19583.33	3916.67	23500.00	24455.00	141	1.6 (110PS) Turbo D ecoTEC**	20754.16	4150.84	24905.00	25820.00	112
<i>Diesel</i>						1.6 (136PS) Turbo D ecoTEC**	21170.83	4234.17	25405.00	26320.00	119
1.6 (110PS) Turbo D ecoTEC	18283.33	3656.67	21940.00	22855.00	112	1.6 (136PS) Turbo D ecoTEC auto**	22504.16	4500.84	27005.00	27960.00	137
1.6 (136PS) Turbo D ecoTEC	18700.00	3740.00	22440.00	23355.00	119	2.0 (170PS) Turbo D BlueInjection*	21837.50	4367.50	26205.00	27160.00	139
1.6 (136PS) Turbo D ecoTEC auto	20033.33	4006.67	24040.00	24995.00	137	2.0 (170PS) Turbo D auto BlueInjection*	23170.83	4634.17	27805.00	28760.00	150
2.0 (170PS) Turbo D BlueInjection*	19366.66	3873.34	23240.00	24195.00	139	2.0 (210PS) BiTurbo D 4X4 auto BlueInjection*	23670.83	4734.17	28405.00	29960.00	186
2.0 (170PS) Turbo D auto BlueInjection*	20700.00	4140.00	24840.00	25795.00	150	GSi NAV					
SRI NAV						2.0 (260PS) Turbo 4X4 auto	27433.33	5486.67	32920.00	34875.00	199
1.5 (165PS) Turbo	18912.50	3782.50	22695.00	23650.00	139	<i>Diesel</i>					
1.5 (165PS) Turbo auto	20245.83	4049.17	24295.00	25250.00	141	2.0 (210PS) BiTurbo D 4X4 auto BlueInjection*	27433.33	5486.67	32920.00	34475.00	187
<i>Diesel</i>						<p>Please note: On-the-road recommended retail prices (RRP) include number plates and delivery to Retailer of £700.00 (inc. £116.67 VAT) 12 months' Vehicle Excise Duty and new vehicle first registration fee of £55.00. Excludes fuel and insurance.</p> <p>* = Please note: Vehicles with BlueInjection technology will need regular AdBlue® top-ups also between servicing requirements. An indicator integrated into the on-board computer will warn you when you need to top up. More information under www.vauxhall.co.uk/discover-vauxhall/technology/adblue.html</p> <p>In accordance with regulations R (EC) No. 715/2007 and R (EC) No. 692/2008 (in the versions respectively applicable).</p> <p>** = Fitted with 17-inch alloy wheels. Optional alloy wheels are not available.</p>					
1.6 (110PS) Turbo D ecoTEC	18945.83	3789.17	22735.00	23650.00	112						
1.6 (136PS) Turbo D ecoTEC	19362.50	3872.50	23235.00	24150.00	119						
1.6 (136PS) Turbo D ecoTEC auto	20695.83	4139.17	24835.00	25790.00	137						
2.0 (170PS) Turbo D BlueInjection*	20029.16	4005.84	24035.00	24990.00	139						
2.0 (170PS) Turbo D auto BlueInjection*	21362.50	4272.50	25635.00	26590.00	150						

INSIGNIA PRICES

Model Country Tourer	Price (£)	VAT (£)	Total (£)	On-the-road RRP (£)	CO ₂ (g/km)
COUNTRY TOURER					
<i>Diesel</i>					
2.0 (170PS) Turbo D BlueInjection*	20566.66	4113.34	24680.00	25635.00	145
2.0 (170PS) Turbo D auto BlueInjection*	21900.00	4380.00	26280.00	27535.00	157
2.0 (170PS) Turbo D 4X4 BlueInjection*	21400.00	4280.00	25680.00	27235.00	172
2.0 (210PS) BiTurbo D 4X4 auto BlueInjection*	22400.00	4480.00	26880.00	28435.00	188

Please note: On-the-road recommended retail prices (RRP) include number plates and delivery to Retailer of £700.00 (inc. £116.67 VAT) 12 months' Vehicle Excise Duty and new vehicle first registration fee of £55.00. Excludes fuel and insurance.

* = Please note: Vehicles with BlueInjection technology will need regular AdBlue® top-ups also between servicing requirements.

An indicator integrated into the on-board computer will warn you when you need to top up. More information under www.vauxhall.co.uk/discover-vauxhall/technology/adblue.html

In accordance with regulations R (EC) No. 715/2007 and R (EC) No. 692/2008 (in the versions respectively applicable).

INSIGNIA FEATURES/OPTIONS

SAFETY

Driver / passenger airbags

- Driver's airbag • Front passenger's airbag • Two front seat side-impact airbags
- Full-size curtain airbags for driver and front and outer rear seat passengers

Seating

- Height-adjustable front seat head restraints (excluding GSi Nav models) • Three height adjustable rear seat head restraints • Anti-submarining ramps in front seats – Prevents occupants sliding underneath the lap belt during a collision.

Seatbelts

- Height adjustable front inertia-reel lap and diagonal seatbelts • Three inertia-reel lap and diagonal rear seatbelts • Front and outer rear seatbelt pretensioner system – Pretensioners tighten the seatbelt in the event of an accident limiting forward movement. • Front and outer rear seatbelt force limiters – Reduces potential upper body injuries during a frontal impact.
- Front 'seatbelt unfastened' audible warning and warning light

Child safety

- Deactivation switch for front passenger's front and side-impact airbags – Permits the safe use of a child seat in the front passenger seat. • ISOFIX child seat mountings incorporating top tether anchor points located on outer rear seats (does not include child seat) – Allows ISOFIX child safety seats to be securely fixed into the car. The ISOFIX mounting system reduces forward movement in an accident and makes the child seat easier to install. • Child-proof locks on rear doors

Driver / passenger safety

- Energy-absorbing steering column • Pedal release system – Reduces potential injury to the driver's legs and feet during a severe frontal impact. • Laminated windscreen • Side-impact protection beams • Reinforced passenger safety cell • Deformation zones front and rear
- Burst-proof door locks and anti-jam door design

Pedestrian safety

- Active bonnet / headlight / wiper structure – Designed to reduce pedestrian head and upper body injuries. The active bonnet travels backwards and upwards to help prevent impact between pedestrian's head and underbonnet components.
- Upper and lower bumper design – Reduces upper and lower leg injuries.

Stability

Electronic Stability Programme (ESP):

– Works in conjunction with the vehicle's electronic braking and engine systems to keep the car stable in many different situations. ESP monitors many different inputs to determine when the car starts to lose traction, it can then immediately respond by varying the brake pressure between up to three wheels and adjust the engine output to help correct the loss of traction and improve stability.

Additional ESP features:

- Traction control • Cornering brake control • Straight line stability control • Rollover mitigation • Drag torque control – Maintain stability on slippery roads when lifting off the accelerator or changing gear.

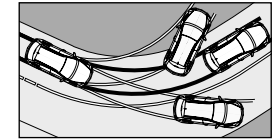

Braking

Anti-lock Braking System (ABS):

– Prevents the vehicle's wheels from locking up under heavy braking by momentarily reducing brake pressure at the appropriate wheel, ensuring that you can maintain control of the steering.

Additional braking features:

- The same electronic systems used in the ABS and ESP also deliver exceptional braking performance.
- Emergency brake assist – When emergency braking is detected the vehicle automatically applies the maximum possible braking assistance. • Fading brake support – Compensates for the effects of brake fade • Electronic brakeforce distribution – Automatically apportions the optimum braking force to each wheel. • Adaptive brake lights – Automatically warns other road users of heavy braking.
- Hill start assist – Briefly maintains rear brake pressure to stop the vehicle rolling back on an incline.
- Hazard warning lights

Tyre pressure

- Tyre pressure monitoring system

INSIGNIA FEATURES/OPTIONS

DRIVER ASSISTANCE	Design / Design Nav	SRI / SRI Nav	SRI VX-Line Nav	Tech Line Nav	Elite Nav	GSi Nav	Country Tourer	Price (£) exc. VAT	Total (£) inc. VAT
Electric parking brake • Centre console switch in lieu of handbrake lever • Premium centre console featuring adjustable armrest	●	●	●	●	●	●	●		
Steering • Speed-sensitive electrically assisted power steering	●	●	●	●	●	●	●		
Cruise control with speed limiter <i>Cruise control enables you to maintain a constant speed – making it ideal for economical motorway driving. The speed limiter function can be set to ensure that you do not exceed the speed limit and can be easily overridden if required.</i> • Steering wheel mounted controls	●	●	●	●	●	●	●		
FlexRide (available at extra cost on 1.6 (136PS) Turbo D, 2.0 (170PS) Turbo D, standard on 2.0 (260PS) Turbo and 2.0 (210PS) BiTurbo D 4X4 models) <i>Enables the driver to choose from three distinct driving modes – Normal (default setting), Sport or Tour.</i> • Facia mounted Sport and Tour switches • GSi models include a unique Competition mode	○	○	○	○	○	●	●	708.33	850.00

● = Standard equipment. ○ = Optional at extra cost.

INSIGNIA FEATURES/OPTIONS

DRIVER ASSISTANCE

Driving Assistance Pack One

A wide range of class-leading driver assistance and safety features are controlled by the front camera system

Forward collision alert with automatic city emergency braking:

In certain circumstances and at speeds above 5mph warns when approaching another vehicle too quickly. At speeds above 5mph and up to 50mph the system provides additional braking support to help the driver brake more quickly and effectively in an emergency situation. On dry roads at speeds above 5mph and up to 25mph the vehicle can brake to a full stop. At speeds above 25mph and up to 50mph, if no avoiding action is taken by the driver, the system automatically slows the vehicle with emergency braking.

- Visual warnings – red LEDs projected onto windscreen and visual warning shown in the instrument cluster
- Audible warning • Additional braking support • Low speed collision mitigation braking

 **Warns you of potential accidents**



Following distance indicator:

Indicates how many seconds you are behind the vehicle in front – helping you maintain a safe distance.

- Timings are shown in the driver information display
- Warning light in the instrument cluster if the gap to the vehicle ahead is below that set by the driver

 **Keeps a safe distance**

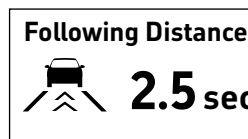

Lane departure warning with lane assist:

If the driver has not actively steered or signalled, the lane departure warning system warns when the car moves outside of lane markings at speeds above 35mph. The lane assist function additionally provides gentle steering correction to help drivers keep in their lane if no active inputs are made.

- Warning light in the instrument cluster • Audible warning • Steering wheel 'nudge' warning • Facia on / off switch

 **Keeps you in lane**



Driving Assistance Pack Two – Automatic cruise control incorporating automatic brake intervention

Automatic cruise control adjusts the vehicle's speed to maintain a time distance to the preceding vehicle, up to the speed that you have set. On models with automatic transmission the 'Stop and Go' function will bring the vehicle to a complete stop and then set off again as the traffic ahead moves away. Automatic brake intervention is active at all speeds above walking pace (2.5mph).

Front and rear parking distance sensors (not available with Driving Assistance Pack Three or Four)

- Audible warning • Distance warning graphic shown in driver information display

 **Easier parking**

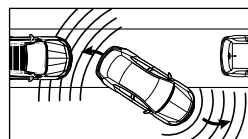

	Design / Design Nav	SRI / SRI Nav	SRI VX-Line Nav	Tech Line Nav	Elite Nav	GSi Nav	Country Tourer	Price (£) exc. VAT	Total (£) inc. VAT
Collision Alert									
Following Distance	●	●	●	●	●	●	●		
Lane departure warning with lane assist									
Driving Assistance Pack Two		○	○	○	○	○	○	475.00	570.00
Front and rear parking distance sensors	○	●	●	●	●	●	●	383.33	460.00

● = Standard equipment. ○ = Optional at extra cost.

INSIGNIA FEATURES/OPTIONS

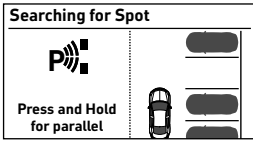
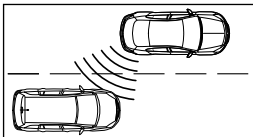
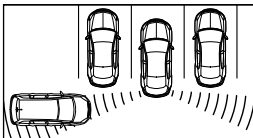
	Design / Design Nav	SRI / SRI Nav	SRI VX-Line Nav	Tech Line Nav	Elite Nav	GSi Nav	Country Tourer	Price (£) exc. VAT	Total (£) inc. VAT
<p>DRIVER ASSISTANCE</p> <p>Rear-view camera (not available with Driving Assistance Pack Three or Four)</p>	○	○	○	○	○	○	○	291.67	350.00
<p>Driving Assistance Pack Three (only available on Nav models. Design Nav models require optional Sight and Light Pack. Includes front and rear parking distance sensors)</p> <p><i>Intelligent ultrasonic sensors form part of the solution for today's crowded roads and car parks – delivering exceptional assistance both when parking and protecting you on the open road.</i></p> <ul style="list-style-type: none"> Electrically foldable door mirrors with puddle lights <p>Advanced park assist:</p> <p><i>Advanced park assist not only detects suitable parking spaces but also expertly steers into them for you. All you have to do is to drive forward or reverse. The system works with both parallel and bay parking.</i></p> <ul style="list-style-type: none"> Ultrasonic side sensors with four-metre range Ultrasonic front and rear parking sensors with a two-metre range Fully automated steering On automatic models, braking is automated Detailed forward/reverse instructions are shown in the instrument cluster or central fascia display <p></p> <p></p> <p></p>	○	○	○	○	○	○	○	854.17	1025.00
<ul style="list-style-type: none"> Finds suitable parking spaces Auto steers into the parking space for you <p>Lane change assist with side blind spot alert:</p> <p><i>Lane change assist with side blind spot alert helps prevent potential collisions with other vehicles 'hidden' in the vehicle's side blind spots. If a vehicle enters one of the blind spots a warning light illuminates in the relevant door mirror.</i></p> <ul style="list-style-type: none"> Ultrasonic side sensors identify vehicles within three-metre range LED warning light in door mirrors, flashes when indicators are used Audible warning is sounded if the indicators are used and the system has detected another vehicle Radar sensors with 70-metre range identify traffic approaching quickly from behind <p> Warns of vehicles in your blind spot</p> <p>360° panoramic camera:</p> <p><i>The camera gives a clear view of the area all around your car and helps place the car perfectly, without needing to strain your neck.</i></p> <ul style="list-style-type: none"> Activated when reverse gear selected, when switched on manually or when very close to an object ahead of or behind the vehicle Camera views appear in infotainment screen Overhead view displayed on the left side of the screen allows you to see clearly how close you are to obstacles in front of and behind you Right side of the screen displays front or rear view, depending on gear selected Rear bumper and grid lines shown as reference points <p> See what's behind you on the central screen</p> <p>Rear cross traffic alert:</p> <p><i>As you reverse the car, this system detects vehicles approaching from the rear and side.</i></p> <ul style="list-style-type: none"> Radar sensors with 20-metre range identify approaching vehicles Warning light in central fascia display Audible warning on relevant side of car 									

● = Standard equipment. ○ = Optional at extra cost.

INSIGNIA FEATURES/OPTIONS

DRIVER ASSISTANCE

Driving Assistance Pack Four (only available on Nav models. Design Nav models require optional Sight and Light Pack. Includes front and rear parking distance sensors. Not available with optional power driver's seat)

Intelligent ultrasonic sensors form part of the solution for today's crowded roads and car parks – delivering exceptional assistance both when parking and protecting you on the open road.

- Electrically foldable door mirrors with puddle lights

Advanced park assist:

Advanced park assist not only detects suitable parking spaces but also expertly steers into them for you. All you have to do is to drive forward or reverse. The system works with both parallel and bay parking.

- Ultrasonic side sensors with four-metre range
- Ultrasonic front and rear parking sensors with a two-metre range
- Fully automated steering
- On automatic models, braking is automated
- Detailed forward/reverse instructions are shown in the instrument cluster or central facia display

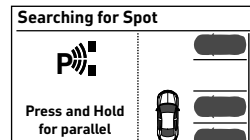

- ✔ Finds suitable parking spaces
- ✔ Auto steers into the parking space for you

Lane change assist with side blind spot alert:

Lane change assist with side blind spot alert helps prevent potential collisions with other vehicles 'hidden' in the vehicle's side blind spots. If a vehicle enters one of the blind spots a warning light illuminates in the relevant door mirror.

- Ultrasonic side sensors identify vehicles within three-metre range
- LED warning light in door mirrors, flashes when indicators are used
- Audible warning is sounded if the indicators are used and the system has detected another vehicle
- Radar sensors with 70-metre range identify traffic approaching quickly from behind

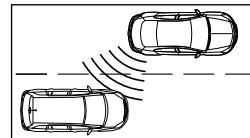

- ✔ Warns of vehicles in your blind spot

Rear-view camera:

The rear-view camera gives a clear view of the area behind your car and helps place the car perfectly, without needing to strain your neck.

- Activated when reverse gear selected
- Camera view appears in infotainment screen
- Rear bumper and grid lines shown as reference points

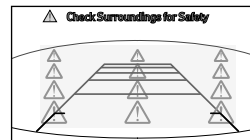

- ✔ See what's behind you on the central screen

Rear cross traffic alert:

As you reverse the car, this system detects vehicles approaching from the rear and side.

- Radar sensors with 20-metre range identify approaching vehicles
- Warning light in central facia display
- Audible warning on relevant side of car

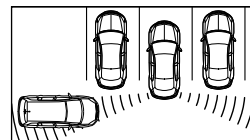

	Design / Design Nav	SRI / SRI Nav	SRI VX-Line Nav	Tech Line Nav	Elite Nav	GSi Nav	Country Tourer	Price (£) exc. VAT	Total (£) inc. VAT
Driving Assistance Pack Four (only available on Nav models. Design Nav models require optional Sight and Light Pack. Includes front and rear parking distance sensors. Not available with optional power driver's seat)									
Lane change assist with side blind spot alert:	○	○	○	○	○			541.67	650.00
Rear-view camera:									
Rear cross traffic alert:									

● = Standard equipment. ○ = Optional at extra cost.

INSIGNIA FEATURES/OPTIONS

	Design / Design Nav	SRI / SRI Nav	SRI VX-Line Nav	Tech Line Nav	Elite Nav	GSi Nav	Country Tourer	Price (£) exc. VAT	Total (£) inc. VAT
SECURITY									
Standard security features • Electronically protected audio equipment • Engine deadlock immobiliser • Visible Vehicle Identification Number (VIN) • Locking wheel bolts for alloy wheels • Freewheeling door locks	●	●	●	●	●	●	●		
Remote control central locking • Operates on doors, tailgate and fuel filler flap • Deadlocking • Central locking activation switch on driver's door • Keyless entry with two transmitter fobs	●	●	●	●	●	●	●	250.00	300.00
Remote control ultrasonic security alarm system • Remote control (operates in conjunction with central locking) • Ultrasonic interior sensors • Tilt sensor • Independent power supply • Thatcham approved (T1)	●	●	●	●	●	●	●		
Keyless start with engine start/stop button	●	●	●	●	●	●	●		
DRIVER INFORMATION									
Instrumentation • Speedometer • Rev counter • Digital fuel gauge with low fuel level warning light • Digital water temperature gauge with warning light • Shift-up/down indication light – <i>Indicates when to change gear for optimum fuel economy.</i>	●	●	●	●	●	●	●		
Driver information display (centrally located in instrument cluster) Displays: • Trip computer data • Total mileage • Service-due indicator • Oil life • Tyre pressure monitoring system • 3.5-inch monochrome display (non-Nav models) • 4.2-inch colour display (Nav models) • 8-inch colour display incorporating speedometer and supplementary audio, phone and navigation information (only available on Nav models)	●	●	●	●	●	●	●	345.83	415.00
Head-up display (only available on Nav models, in conjunction with 8-inch colour display) <i>Projects key information onto the windscreen so that the driver's eyes remain on the road at all times. The display is adjustable for height and brightness.</i> Displays: • Navigation directions • Audio and phone information • Speedometer • Rev counter • Selected gear and gear shift indicator • Set speed of cruise control and speed limiter • Forward collision alert • Following distance indicator gap adjustment • Lane assist and lane departure warning • Pedestrian alert <i>Please note: The red LEDs of the forward collision alert system are replaced by a warning symbol</i>		○	○	○	○	●	○	241.67	290.00
Multi-function trip computer (displayed on driver information display) • Trip mileage • Vehicle range based on remaining fuel • Average speed • Average fuel economy • Instantaneous fuel economy • Driving time	●	●	●	●	●	●	●		
Central facia display (format dependent on infotainment unit) • Audio information • Digital clock with automatic RDS time adjustment • Outside air temperature with ice warning function • Additional features dependent on infotainment unit (see infotainment for details)	●	●	●	●	●	●	●		

● = Standard equipment. ○ = Optional at extra cost.

INSIGNIA FEATURES/OPTIONS

INTERIOR STYLING	Design / Design Nav	SRi / SRi Nav	SRi VX-Line Nav	Tech Line Nav	Elite Nav	GSi Nav	Country Tourer	Price (£) exc. VAT	Total (£) inc. VAT
Design interior décor Steering wheel: • Three-spoke design • Leather-covered • Satin chrome-effect bezel Facia and door trim: • Black facia • Black door panels with black Atlantis cloth inserts • Metallic silver Raute trim inserts • Chrome-effect interior door handles Headlining: • Light fabric	●								
SRi interior décor Steering wheel: • Three-spoke design • Leather-covered, perforated • Satin chrome-effect bezel Facia and door trim: • Black facia • Silver air vent surrounds • Black door panels with black Morrocana inserts (standard seats); black leather-effect inserts (optional AGR sports seats) • Dark metallic Hexagon trim inserts • Chrome-effect interior door handles Pedals: • Sports, alloy-effect Headlining: • Light fabric Front door sill covers: • Alloy-effect		●							
SRi VX-Line Nav interior décor Steering wheel: • Three-spoke VX-Line design, flat bottom • Leather-covered, perforated • Electrically heated • Satin chrome-effect bezel Facia and door trim: • Black facia • Silver air vent surrounds • Black door panels with black Morrocana inserts (standard seats); black leather-effect inserts (optional AGR sports seats) • Dark metallic Hexagon trim inserts • Chrome-effect interior door handles Pedals: • Sports, alloy-effect Headlining: • Dark fabric Front door sill covers: • Alloy-effect			●						
Tech Line Nav / Country Tourer interior décor Steering wheel: • Three-spoke design • Leather-covered • Satin chrome-effect bezel Facia and door trim: • Black facia • Black door panels with black leather-effect inserts • Dark silver Agate trim inserts • Chrome-effect interior door handles Headlining: • Light fabric Floor mats: • Velour, front and rear (Country Tourer models only) Front door sill covers: • Alloy-effect				●			●		
Elite Nav interior décor Steering wheel: • Three-spoke design • Leather-covered • Satin chrome-effect bezel Facia and door trim: • Black facia • Silver air vent surrounds • Black door panels with black leather-effect inserts (standard and optional black leather AGR sports seats); shale leather-effect inserts (optional shale leather AGR sports seats) • Dark silver Agate trim inserts • Chrome-effect interior door handles Headlining: • Light fabric Front door sill covers: • Alloy-effect					●				

● = Standard equipment. ○ = Optional at extra cost.

INSIGNIA FEATURES/OPTIONS

INTERIOR STYLING

	Design / Design Nav	SRI / SRI Nav	SRI VX-Line Nav	Tech Line Nav	Elite Nav	GSI Nav	Country Tourer	Price (£) exc. VAT	Total (£) inc. VAT
GSI Nav interior décor Steering wheel: • Three-spoke VX-Line design, flat bottom • Leather-covered, perforated • Electrically heated • Satin chrome-effect bezel Facia and door trim: • Black facia • Silver air vent surrounds • Black door panels with black leather-effect inserts • Dark metallic Hexagon trim inserts • Chrome-effect interior door handles Pedals: • Sports, alloy-effect Headlining: • Dark fabric Floor mats: • Velour, front and rear Front door sill covers: • Alloy-effect						●			
VXR Interior Pack Steering wheel: • Three-spoke VX-Line design, flat bottom • Leather-covered, perforated • Electrically heated • Satin chrome-effect bezel • Paddle shift on automatic models Pedals: • Sports, alloy-effect Headlining: • Dark fabric		○	●	○	○	●	○	337.50	405.00

● = Standard equipment. ○ = Optional at extra cost.

INSIGNIA FEATURES/OPTIONS

SEATING AND COMFORT	Design / Design Nav	SRI / SRI Nav	SRI VX-Line Nav	Tech Line Nav	Elite Nav	GSi Nav	Country Tourer	Price (£) exc. VAT	Total (£) inc. VAT
Reach and rake adjustable steering	●	●	●	●	●	●	●		
Comfort front seats Driver's seat (eight-way adjustable): • Height • Reach • Backrest • Head restraint Front passenger's seat (six-way adjustable): • Reach • Backrest • Head restraint Seat trim: • Milano fabric seat trim inserts • Plain black fabric side bolsters		●							
Comfort front seats Driver's seat (16-way adjustable): • Height • Reach • Tilt • Backrest • Lumbar adjustment (four-way electrical) • Head restraint (four-way) Front passenger's seat (10-way adjustable): • Height • Reach • Backrest • Head restraint (four-way) • Heated front seats • Heated outer rear seats (Grand Sport 4X4 and all Sports Tourer models) Seat trim: • Oxford fabric seat trim inserts with contrast stitching • Black Morrocana side bolsters • Black Siena leather seat trim inserts • Black Morrocana side bolsters				●	●		●		
Ergonomic driver's sports-style seat (AGR-approved*) with sports-style front passenger seat Driver's seat (18-way adjustable): • Height • Reach • Tilt • Backrest • Seat cushion extension • Lumbar adjustment (four-way electrical) • Head restraint (four-way) Front passenger's seat (eight-way adjustable): • Reach • Backrest • Head restraint (four-way) <i>Please note: On Design models the driver's and front passenger's head restraints are only adjustable up and down</i> Seat trim: • Milano fabric seat trim inserts • Plain black fabric side bolsters • Monita fabric seat trim inserts • Black Morrocana side bolsters		●	●						
	○							354.17	425.00

● = Standard equipment. ○ = Optional at extra cost. * = AGR (The Campaign for Healthier Backs) is an independent centre of excellence for ergonomics, based in Germany.

INSIGNIA FEATURES/OPTIONS

	Design / Design Nav	SRI / SRI Nav	SRI VX-Line Nav	Tech Line Nav	Elite Nav	GSi Nav	Country Tourer	Price (£) exc. VAT	Total (£) inc. VAT
SEATING AND COMFORT									
Ergonomic sports-style front seats (AGR-approved*)									
Driver's and front passenger's seat (18-way adjustable):									
• Height • Reach • Tilt • Backrest • Seat cushion extension • Lumbar adjustment (four-way electrical)									
• Head restraint (four-way)									
• Heated front seats • Heated outer rear seats • FlexFold 40/20/40 split-folding rear seat back									
Seat trim:									
• Black Siena perforated leather seat trim inserts • Black Morrocana side bolsters									
• Shale Siena perforated leather seat trim inserts • Shale Morrocana side bolsters									
Premium ergonomic sports front seats (AGR-approved*)									
Driver's and front passenger's seat (14-way adjustable):									
• Height (electrical) • Reach (electrical) • Tilt (electrical) • Backrest (electrical) • Seat cushion extension									
• Lumbar adjustment (four-way electrical) • Massage functions • Active ventilation									
• Pneumatically adjustable backrest side bolsters • Driver's seat memory function, including door mirrors									
• Heated front seats • Heated outer rear seats • FlexFold 40/20/40 split-folding rear seat back									
Seat trim:									
• Black Siena perforated leather seat trim inserts • Black Morrocana side bolsters									
Power driver's seat (only available in conjunction with leather Ergonomic sports-style front seats. Not available with optional Driving Assistance Pack Four)									
The following features are electrically adjustable:									
• Height • Reach • Tilt • Backrest • Lumbar adjustment • Massage functions									
• Pneumatically adjustable backrest side bolsters • Driver's seat memory function, including door mirrors									
• Active ventilation for driver's and front passenger's seats • Electrically foldable door mirrors with puddle lights									
Power driver's seat (only available on models with cloth trim. Not available with optional Driving Assistance Pack Four)									
The following features are electrically adjustable:									
• Height • Reach • Tilt • Backrest • Lumbar adjustment • Massage functions									
• Pneumatically adjustable backrest side bolsters • Driver's seat memory function, including door mirrors									
• Heated front seats • Electrically foldable door mirrors with puddle lights									
Rear seating									
• Three person layout • Three height-adjustable and removable head restraints • ISOFIX child seat mountings incorporating top tether anchor points located on outer rear seats (does not include child seat) – Allows ISOFIX child safety seats to be securely fixed into the car.									
The ISOFIX mounting system reduces forward movement in an accident and makes the child seat easier to install.									
• Child-proof locks on rear doors									
• 60/40 split-folding rear seat back (Grand Sport models, excluding 4X4, and Design / Design Nav Sports Tourer models)									
• FlexFold 40/20/40 split-folding rear seat back with one-touch release (Grand Sport 4X4 and all Sports Tourer / Country Tourer models) – Also fitted to all models in conjunction with optional leather-covered ergonomic sports-style front seats.									
• Centre rear armrest									

● = Standard equipment. ○ = Optional at extra cost. * = AGR (The Campaign for Healthier Backs) is an independent centre of excellence for ergonomics, based in Germany.







INSIGNIA FEATURES/OPTIONS

INFOTAINMENT

	Design / Design Nav	SRI / SRI Nav	SRI VX-Line Nav	Tech Line Nav	Elite Nav	GSi Nav	Country Tourer	Price (£) exc. VAT	Total (£) inc. VAT
R4.0 IntelliLink touchscreen infotainment system <i>For use with media players, USB memory sticks, mobile phones and smartphone apps</i> Onboard features: • 7-inch colour touchscreen • DAB digital radio/AM/FM stereo radio • RDS with Traffic Programme Media connections: • USB connection with iPod control in front centre armrest • Bluetooth® A2DP audio streaming (Advanced Audio Distribution Profile) Mobile phone portal: • Bluetooth® connectivity • Handsfree calls via steering wheel controls • Vehicle microphone • Phone book access – <i>Contacts/last calls/missed calls etc. are mirrored on IntelliLink's display and are easily navigated using the touchscreen (features dependent on mobile phone).</i> Smartphone interface: • Apple CarPlay™ • Android Auto™ – <i>Smartphone projection that allows operations via voice command, touchscreen and buttons to control apps and music playback.</i>	●	●							
Navi 900 IntelliLink touchscreen navigation and infotainment system <i>For use with media players, USB memory sticks, mobile phones and smartphone apps</i> Onboard features: • 8-inch colour touchscreen • DAB digital radio/AM/FM stereo radio • RDS with Traffic Programme • 60 configurable favourites including contacts, addresses, playlists, radio stations and voice recognition Navigation features: • Satellite navigation system • 3D street level mapping • European coverage Media connections: • USB connection with iPod control in front centre armrest • Bluetooth® A2DP audio streaming (Advanced Audio Distribution Profile) Mobile phone portal: • Bluetooth® connectivity • Handsfree calls via steering wheel controls • Vehicle microphone • Phone book access – <i>Contacts/last calls/missed calls etc. are mirrored on IntelliLink's display and are easily navigated using the touchscreen (features dependent on mobile phone).</i> • SMS read out and reply Smartphone interface: • Apple CarPlay™ • Android Auto™ – <i>Smartphone projection that allows operations via voice command, touchscreen and buttons to control apps and music playback.</i> Traffic sign recognition: • Recognises different road signs, including temporary speed restrictions • Displays reminder in the driver information centre and, where fitted, the head-up display	▲	▲	●	●	●	●	●		
Seven speakers (five front, two rear)	●	●	●	●	●		●		
Bose® Premium Sound System (only available on Nav models, standard on 2.0 (260PS) Turbo 4X4 and 2.0 (210PS) BiTurbo D 4X4 models. Not available in conjunction with optional emergency spare wheel) • 4x45w channels • Bose® digital amplifier with six channels of customised equalisation • 7 premium speakers • Subwoofer • Digital engine sound enhancement for 2.0 (260PS) Turbo 4X4 models, also on 2.0 (210PS) BiTurbo D 4X4 models fitted with optional FlexRide		○	○	○	○	●	○	500.00	600.00
Steering wheel mounted audio controls for phone, music and cruise control	●	●	●	●	●	●	●		
Twin USB power sockets for rear seat passengers		●	●	●	●	●	●		
Wireless charger for mobile devices (Maximum device dimensions 75.7 x 23.6mm. Not suitable for iPhone Plus models)	○	○	○	○	○	○	○	133.33	160.00

● = Standard equipment. ○ = Optional at extra cost. ▲ = Standard on Nav models, see pricing page for details.

INSIGNIA FEATURES/OPTIONS

ONSTAR						Design / Design Nav	SRI / SRI Nav	SRI VX-Line Nav	Tech Line Nav	Elite Nav	GSi Nav	Country Tourer	Price (£) exc. VAT	Total (£) inc. VAT			
																	
Automatic Crash Response	Wi-Fi Hotspot	Smartphone App	Stolen Vehicle Assistance	Vehicle Diagnostics	Destination Download	●	●	●	●	●	●	●					
<p>OnStar – your personal on board assistant*</p> <p><i>Many car brands talk about innovation as soon as they improve their cup holders but this innovative system, now available on selected models**, is revolutionary: 24/7, 365 days a year, OnStar puts you in touch with a trained advisor, not a machine. With OnStar you have access to a host of innovations, from Vehicle Diagnostics and Smartphone Function to a fully integrated 4G Wi-Fi Hotspot†. In the event of an accident, OnStar even automatically calls for help, for an incomparable feeling of safety.</i></p> <p>* = Includes 12 months of OnStar services from date of first registration and a 3 month/3 GB Wi-Fi free trial period (whichever comes first) effective from the date the customer accepts the nominated network operator Wi-Fi Ts&Cs. Destination download feature only operates on models fitted with Navi 900 IntelliLink satellite navigation system.</p> <p>** = The OnStar Services require activation and are subject to mobile network coverage and availability. Wi-Fi Hotspot service requires account with nominated network operator.</p> <p>† = 4G is subject to mobile network coverage and availability. Charges apply after the free trial period. The OnStar subscription packages could be different from the services included in the free trial package. Check www.vauxhall.co.uk/onstar for terms and conditions, details of availability, coverage and charges.</p>																	

● = Standard equipment.

INSIGNIA FEATURES/OPTIONS

	Design / Design Nav	SRI / SRI Nav	SRI VX-Line Nav	Tech Line Nav	Elite Nav	GSi Nav	Country Tourer	Price (£) exc. VAT	Total (£) inc. VAT
HEATING AND VENTILATION									
Air conditioning • Air recirculation facility • Cabin particulate filter – Removes dust, airborne particles and pollen. • Multi-speed fan • Illuminated controls • Rear floor heating ducts	●								
Electronic climate control including air conditioning • Dual-zone control – Allowing different temperature settings for driver and front passenger • Automatic front seat heating – On models ordered with Winter Pack or leather trim, front seat heating is switched on automatically to help achieve the requested interior temperature. • Advanced predictive logic control system using sun and humidity sensors • Partial air recirculation – Faster warm up/cool down. • Cabin particulate filter – Removes dust, airborne particles and pollen. • Automatic air direction and fan speed with manual override • LCD temperature display • Illuminated controls • Rear floor heating ducts ✓ Set and forget temperature control ✓ Set different temperature for driver and front passenger	○	●	●	●	●	●	●	337.50	405.00
Additional features • Four adjustable facia vents • Windscreen demist vents • Side window demist vents	●	●	●	●	●	●	●		
Winter Pack One – models with cloth trim, without VXR Interior Pack • Heated leather-covered steering wheel • Heated front seats – Three temperature settings. • Heated windscreen ✓ Warm welcome	○	○		○			○	550.00	660.00
Winter Pack Two – models with leather trim, without VXR Interior Pack • Heated leather-covered steering wheel • Heated windscreen ✓ Warm welcome		○		○	○		○	333.33	400.00
Winter Pack Three – models with leather trim and VXR Interior Pack • Heated windscreen		○	○	○	○	○	○	125.00	150.00
Winter Pack Four – models with cloth trim and VXR Interior Pack • Heated front seats – Three temperature settings. • Heated windscreen ✓ Warm welcome		○	○	○			○	341.67	410.00

● = Standard equipment. ○ = Optional at extra cost.

INSIGNIA FEATURES/OPTIONS

INTERIOR CONVENIENCE / LIGHTING	Design / Design Nav	SRI / SRI Nav	SRI VX-Line Nav	Tech Line Nav	Elite Nav	GSi Nav	Country Tourer	Price (£) exc. VAT	Total (£) inc. VAT
Convenience features • Front 12-volt electrical accessory socket • Driver's and front passengers sunvisors • Driver's and front passenger's vanity mirrors • Dipping rear-view mirror	●	●	●	●	●	●	●		
Automatically dimming anti-dazzle rear-view mirror – <i>On Design models, fitted in conjunction with Sight and Light Pack. Not available separately.</i>	□	●	●	●	●	●	●		
Front centre adjustable armrest with 4-litre storage capacity (2.8 litres if optional wireless charger is ordered)	●	●	●	●	●	●	●		
Standard ambient lighting • Central front courtesy light • Central rear courtesy light • Fade up/fade down • Twin front reading lights with illuminated switches • Twin rear reading lights • Ambient LED facia/centre console downlighter	●	●	●	●	●	●	●		
Premium ambient lighting • Driver's and front passenger's LED illuminated vanity mirrors with flip-up covers • Ambient LED lighting in front doors and below audio unit		●	●	●	●	●	●		
Interior storage • Illuminated glovebox with lid • Front door pockets with 1.5-litre bottle holder • Two drinks holders in centre console • Rear door pockets with 1-litre bottle holder	●	●	●	●	●	●	●		
• Storage pockets on front seat backs		●	●	●	●		●		
Luggage area • Luggage compartment cover (Grand Sport models) • Luggage compartment retractable cover (Sports Tourer / Country Tourer models) • Illuminated load area • Fully carpeted load area • Interior tailgate handle • Four load restraint lashing eyes • Twin gas-assisted tailgate struts • Storage tray in spare wheel well	●	●	●	●	●	●	●		
Luggage compartment 12-volt electrical accessory socket (Sports Tourer / Country Tourer models)		●	●	●	●	●	●		
FlexOrganiser® Pack (Sports Tourer / Country Tourer models) • Four side rails • 3D storage net • Side net pocket • Four side rail hooks	○	○	○	○	○	●	○	100.00	120.00



● = Standard equipment. ○ = Optional at extra cost. □ = Available as part of an extra-cost option pack.

INSIGNIA FEATURES/OPTIONS

	Design / Design Nav	SRI / SRI Nav	SRI VX-Line Nav	Tech Line Nav	Elite Nav	GSi Nav	Country Tourer	Price (£) exc. VAT	Total (£) inc. VAT
EXTERIOR LIGHTING									
Standard lighting features									
<ul style="list-style-type: none"> • LED daytime running lights • LED tail lights • Automatic lighting control: When the automatic lighting control is switched on, the system switches between daytime running lights and headlights automatically depending on external lighting conditions. • LED side repeat indicators • Lights-on audible warning: When driver's door is opened an audible warning sounds to alert the lights have been left on. • Manual headlight beam levelling: Use to adapt headlight range to the vehicle load to prevent dazzling. • LED brake lights • High-level LED centre rear brake light • Rear fog light • Reversing light • Hazard warning lights • Door-to-door illumination: Headlights illuminate the area for an adjustable time after leaving the vehicle. • Welcome lighting: Headlights and tail lights illuminate when the vehicle is unlocked. 	●	●	●	●	●	●	●		
<ul style="list-style-type: none"> • Automatic lighting control with tunnel detection – On Design models, fitted in conjunction with Sight and Light Pack. Not available separately. 	□	●	●	●	●	●	●		
Front fog lights – also fitted as part of Plus Pack on Design and Tech Line Nav models, where available.	○	●	●	○	●		●	141.67	170.00
IntelliLux LED® Matrix headlights									
<p>IntelliLux LED® Matrix headlights work with the standard Driving Assistance Pack One incorporating front camera system, to provide outstanding lighting performance and enhanced safety. Each headlight features a matrix of 16 individual LED lights. These lights replace both the dipped beam and main beam functions. Each LED illuminates a separate part of the road ahead meaning that by automatically switching lights on and off, illumination is varied to suit traffic and road conditions.</p> <p>The IntelliLux system calculates which LED lights are activated and deactivated using additional data such as ambient light conditions, vehicle speed, steering angle and when the indicators are used. For example, when the front camera system detects an oncoming vehicle, the individual LED lights that would dazzle the oncoming driver are automatically switched off and then switched back on once the vehicle has passed. All other areas remain fully illuminated.</p>									
<p>Every type of driving environment has been considered:</p> <p>Urban light: With street lighting and speeds up to 34mph, the system automatically enhances the dipped beam function.</p> <p>Highway light: The system recognises when the car is on a dual carriageway or motorway. At higher speeds the light distribution on the right is reduced to minimise glare from the crash barriers whilst the left-side beam is lengthened.</p> <p>Country light: As speeds increase, so does the lighting's performance, illuminating the nearside of the road.</p> <p>Static Cornering light: At lower speeds corners and bends are illuminated to match steering inputs.</p> <p>Parking light: When reversing, additional side-facing lights are activated in the headlights.</p> <p>Tourist mode: The lighting pattern can be adjusted when travelling abroad.</p> <p>Energy saving mode: The IntelliLux LED® Matrix system goes into energy saving mode when the engine is automatically stopped.</p> <ul style="list-style-type: none"> • Dipped beam, main beam and dynamic lighting: 32 electronically controlled LED lights (16 per headlight) • Intelligent main beam control • Automatic headlight levelling 									
<ul style="list-style-type: none"> ✓ Smart headlights automatically adjust the shape of high beam ✓ No need to switch between high and low beam ✓ High beam is always glare free 									
<p>Sight and Light Pack</p> <ul style="list-style-type: none"> • Automatic lighting control with tunnel detection • Rain-sensitive windscreen wipers • Automatically dimming anti-dazzle rear-view mirror • High beam assist 	○	●	●	●	●	●	●	200.00	240.00

● = Standard equipment. ○ = Optional at extra cost. □ = Available as part of an extra-cost option pack.

INSIGNIA FEATURES/OPTIONS

	Design / Design Nav	SRI / SRI Nav	SRI VX-Line Nav	Tech Line Nav	Elite Nav	GSi Nav	Country Tourer	Price (£) exc. VAT	Total (£) inc. VAT
EXTERIOR CONVENIENCE									
Windscreen wipers	●	●	●	●	●	●	●		
• Two-speed windscreen wipers with variable intermittent wipe									
• Rain-sensitive windscreen wipers – <i>On Design models, fitted in conjunction with Sight and Light Pack. Not available separately.</i>	□	●	●	●	●	●	●		
• Intermittent rear window wash/wipe (Grand Sport models)	N/C	N/C	N/C	N/C	N/C	N/C		No-cost option	
• Intermittent rear window wash/wipe (Sports Tourer / Country Tourer models)	●	●	●	●	●	●	●		
Door mirrors	●	●	●	●	●	●	●		
• Twin electrically adjustable/heated door mirrors • Manually folding door mirrors									
• Electrically foldable door mirrors with puddle lights – <i>Fitted as part of Driving Assistance Pack Three and Four and in conjunction with power driver's seat. Not available separately.</i>	□	□	□	□	□	●	□		
Windows	●	●	●	●	●	●	●		
• Electrically operated front and rear windows with safety autoreverse and one-touch up/down facility • Heated rear window									
• Solar heat-absorbing windscreen • Tinted windows	●	●	●	●	●	●	●		
• Dark-tinted rear windows		●	●	○	●	●	●	237.50	285.00
• Noise-reducing laminated side windows	○	○	○	○	○	○	○	183.33	220.00
Glass sunroof (Grand Sport models)	○	○	○	○	○	○		587.50	705.00
• Electrically operated tilt and slide glass sunroof section, located above front seats • Electrically operated sunblind									
Panoramic glass sunroof (Sports Tourer / Country Tourer models)	○	○	○	○	○	○	○	800.00	960.00
• Electrically operated tilt and slide glass sunroof section, located above front seats									
• Additional fixed panoramic glass rear sunroof • Electrically operated sunblinds									
Power tailgate (Sports Tourer / Country Tourer models)		○	○	○	○		○	566.67	680.00
• Keyless entry with two transmitter fobs • Under-bumper release sensor • Tailgate close switch									
• Maximum opening height can be set to avoid damage in areas with low ceiling heights									
									 Easy load access
Power tailgate (Sports Tourer models)						○		316.67	380.00
• Under-bumper release sensor • Tailgate close switch									
• Maximum opening height can be set to avoid damage in areas with low ceiling heights									
									 Easy load access
Roof rails (Sports Tourer / Country Tourer models)	●								
• Black		●	●	●	●	●	●		
• Silver-effect									
Towing Pack	○	○	○	○	○		○	570.83	685.00
• Retractable tow bar • Trailer stability programme integrated into ESP system									









● = Standard equipment. ○ = Optional at extra cost. N/C = No-cost option. □ = Available as part of an extra-cost option pack.

INSIGNIA FEATURES/OPTIONS

EXTERIOR STYLING	Design / Design Nav	SRi / SRi Nav	SRi VX-Line Nav	Tech Line Nav	Elite Nav	GSi Nav	Country Tourer	Price (£) exc. VAT	Total (£) inc. VAT
Body styling	●	●	●	●	●	●	●		
• Chrome-effect front grille bar • Body-colour door mirrors	●	●	●	●	●	●	●		
• Chrome-effect upper window trim (excluding Design Grand Sport models)	●	●	●	●	●	●	●		
• Body-colour door handles	●	●	●						
• Body-colour door handles with chrome-effect insert				●	●	●	●		
• Rear spoiler (Grand Sport models)		●	●						
• Matt black B-pillars	●								
• Gloss black B-pillars		●	●	●	●	●	●		
• Matt black lower window trim	●	●	●						
• Gloss black lower window trim				●	●	●	●		
• GSi front and rear bumpers and side sills						●			
• GSi rear spoiler (Grand Sport models)						●			
• Visible exhaust tailpipes (excluding Grand Sport 1.5 (165PS) Turbo models)		□	●	□	□	●			
• Anthracite wheel arch and side sill extensions							●		
• Front and rear bumpers incorporating silver-effect skid plates							●		
VXR Styling Pack (not available on 1.6 Turbo D (110PS) ecoTEC models)									
• Sports-style front and rear bumpers • Side sills • Rear spoiler (Grand Sport models)		○	●	○	○			708.33	850.00
• Visible exhaust tailpipe (excluding Grand Sport 1.5 (165PS) Turbo models)									
Design Plus Pack (not available on 1.6 diesel ecoTEC models)									
• 18-inch bi-colour alloy wheels • 245/45 R 18 tyres • Front fog lights	○							500.00	600.00
Tech Line Nav Plus Pack (not available on 1.6 diesel ecoTEC models)									
• 18-inch bi-colour alloy wheels • 245/45 R 18 tyres • Front fog lights				○				416.67	500.00

● = Standard equipment. ○ = Optional at extra cost. □ = Available as part of an extra-cost option pack.





INSIGNIA FEATURES/OPTIONS

EXTERIOR COLOURS		Design / Design Nav	SRI / SRI Nav	SRI VX-Line Nav	Tech Line Nav	Elite Nav	GSi Nav	Country Tourer	Price (£) exc. VAT	Total (£) inc. VAT
	Aegean Blue • Solid paint	●	●	●	●	●				
	Summit White • Brilliant paint	○	○	○	○	○	●	○	237.50	285.00
	Lava Red • Brilliant paint	○	○	○	○	○	○	○	237.50	285.00
	Satin Steel Grey • Two-coat metallic paint • Not available on GSi Nav models									
	Mineral Black • Two-coat metallic paint									
	Cosmic Grey • Two-coat pearlescent paint									
	Flip Chip Silver • Two-coat metallic paint • Not available on GSi Nav models									
	Sovereign Silver • Two-coat metallic paint	○	○	○	○	○	○	○	470.83	565.00

● = Standard equipment. ○ = Optional at extra cost.

The colours reproduced may vary slightly from the actual paint colour. As a result they should be used as a guide only. Your Vauxhall Retailer has a comprehensive display of our paint samples.



INSIGNIA FEATURES/OPTIONS

EXTERIOR COLOURS		Design / Design Nav	SRI / SRI Nav	SRI VX-Line Nav	Tech Line Nav	Elite Nav	GSi Nav	Country Tourer	Price (£) exc. VAT	Total (£) inc. VAT
	Emerald Green • Two-coat premium paint		Dark Caramel • Two-coat premium paint							
	Darkmoon Blue • Two-coat premium paint		Rioja Red • Two-coat premium paint	○	○	○	○	○	545.83	655.00
	Abalone White • Tri-coat premium paint			○	○	○	○	○	604.17	725.00

● = Standard equipment. ○ = Optional at extra cost.







The colours reproduced may vary slightly from the actual paint colour. As a result they should be used as a guide only. Your Vauxhall Retailer has a comprehensive display of our paint samples.

INSIGNIA FEATURES/OPTIONS

WHEELS AND TYRES		Design / Design Nav	SRI / SRI Nav	SRI VX-Line Nav	Tech Line Nav	Elite Nav	GSi Nav	Country Tourer	Price (£) exc. VAT	Total (£) inc. VAT
Steel emergency spare wheel offer – 16-inch / 17-inch										
1.5 (140PS) Turbo ecoTEC (Grand Sport / Sports Tourer 16-inch)		○								
1.5 (165PS) Turbo / 1.5 (165PS) Turbo auto (Grand Sport 16-inch / Sports Tourer 17-inch)		○	○	○	○	○				
1.6 (110PS) Turbo D ecoTEC (Grand Sport / Sports Tourer 16-inch)		○	○		○	○				
1.6 (136PS) Turbo D ecoTEC (Grand Sport 16-inch / Sports Tourer 17-inch)		○	○	○	○	○			91.67	110.00
1.6 (136PS) Turbo D auto (Grand Sport / Sports Tourer 17-inch)		○	○	○	○	○				
2.0 (170PS) Turbo D BlueInjection manual / auto (Grand Sport / Sports Tourer / Country Tourer 17-inch)		○	○	○	○	○		○		
2.0 (170PS) Turbo D 4X4 BlueInjection (Country Tourer 17-inch)								○		
	17-inch bi-colour structure wheels <ul style="list-style-type: none"> • 215/55 R 17 ultra-low rolling resistance tyres (1.6 diesel ecoTEC engines) • Emergency tyre inflation kit (in lieu of spare wheel) 	●								
	17-inch five twin-spoke alloy wheels <ul style="list-style-type: none"> • 215/55 R 17 ultra-low rolling resistance tyres (1.6 diesel ecoTEC engines) • 225/55 R 17 tyres (excluding 1.6 diesel ecoTEC engines) • Emergency tyre inflation kit (in lieu of spare wheel) 		●		●					
	• All models excluding 1.6 diesel ecoTEC	●								
	• 1.6 diesel ecoTEC models only. Not available with other models			●		●				

● = Standard equipment. ○ = Optional at extra cost.

INSIGNIA FEATURES/OPTIONS

WHEELS AND TYRES		Design / Design Nav	SRI / SRI Nav	SRI VX-Line Nav	Tech Line Nav	Elite Nav	GSi Nav	Country Tourer	Price (£) exc. VAT	Total (£) inc. VAT
	18-inch five-spoke alloy wheels <ul style="list-style-type: none"> • 245/45 R 18 tyres • Emergency tyre inflation kit (in lieu of spare wheel) • Not available on 1.6 (136PS) diesel ecoTEC models 			●						
	18-inch bi-colour alloy wheels <ul style="list-style-type: none"> • 245/45 R 18 tyres • Emergency tyre inflation kit (in lieu of spare wheel) • Not available on 1.6 diesel ecoTEC or 2.0 (260PS) Turbo 4X4 models • Available as part of Plus Pack on Design and Tech Line Nav models 	○	○		○	●			420.83	505.00
	18-inch bi-colour five twin-spoke alloy wheels <ul style="list-style-type: none"> • 235/50 R 18 tyres • Emergency tyre inflation kit (in lieu of spare wheel) 							●		
	20-inch five twin-spoke alloy wheels <ul style="list-style-type: none"> • 245/35 R 20 tyres • Emergency tyre inflation kit (in lieu of spare wheel) • Only available as an option on 2.0 (170PS) Turbo D models 		○		○				829.17	995.00
				○		○				733.33
	20-inch five twin-spoke alloy wheels <ul style="list-style-type: none"> • Standard on 2.0 (260PS) Turbo 4X4 models • Standard on 2.0 (210PS) BiTurbo D 4X4 models 					●				
								●		
	20-inch bi-colour five twin-spoke alloy wheels <ul style="list-style-type: none"> • 245/35 R 20 Michelin Pilot Sport 4S tyres • Emergency tyre inflation kit (in lieu of spare wheel) 							●		

● = Standard equipment. ○ = Optional at extra cost.

INSIGNIA SPECIFICATIONS

PETROL ENGINES

	1.5 (140PS) Turbo ecoTEC with Start/Stop	1.5 (165PS) Turbo with Start/Stop	2.0 (260PS) Turbo with Start/Stop
Capacity	1490cc	1490cc	1998cc
Maximum power	140PS (103kW) @ 5600rpm	165PS (121kW) @ 5600rpm	260PS (191kW) @ 5300rpm
Maximum torque	250Nm (184 lb.ft.) @ 2000-4100rpm	250Nm (184 lb.ft.) @ 2000-4500rpm	400Nm (295 lb.ft.) @ 3000-4000rpm
Configuration	4 cylinders, 4 valves per cylinder, double overhead camshafts	4 cylinders, 4 valves per cylinder, double overhead camshafts	4 cylinders, 4 valves per cylinder, double overhead camshafts
Fuel/induction system	Turbocharger with intercooler. Variable Valve Timing (VVT). Direct fuel injection	Turbocharger with intercooler. Variable Valve Timing (VVT), Direct fuel injection	Twin-scroll turbocharger with intercooler. Variable Valve Timing (VVT). Direct fuel injection
Emission compliance	Euro 6	Euro 6	Euro 6
Service interval	20,000 miles or 1 year (whichever occurs sooner)	20,000 miles or 1 year (whichever occurs sooner)	20,000 miles or 1 year (whichever occurs sooner)

DIESEL ENGINES

	1.6 (110PS) Turbo D ecoTEC with Start/Stop	1.6 (136PS) Turbo D including ecoTEC with Start/Stop
Capacity	1598cc	1598cc
Maximum power	110PS (81kW) @ 3500rpm	136PS (100kW) @ 3500-4000rpm
Maximum torque	300Nm (221 lb.ft.) @ 1750-2000rpm	320Nm (236 lb.ft.) @ 2000-2250rpm
Configuration	4 cylinders, 4 valves per cylinder, double overhead camshafts	4 cylinders, 4 valves per cylinder, double overhead camshafts
Fuel/induction system	Turbocharger with intercooler. Common rail fuel injection	Variable geometry turbocharger with intercooler. Common rail fuel injection
Emission compliance	Euro 6 with Diesel Particulate Filter	Euro 6 with Diesel Particulate Filter
Service interval	20,000 miles or 1 year (whichever occurs sooner)	20,000 miles or 1 year (whichever occurs sooner)

	2.0 (170PS) Turbo D with Start/Stop	2.0 (210PS) BiTurbo D with Start/Stop
Capacity	1956cc	1956cc
Maximum power	170PS (125kW) @ 3750rpm	210PS (154kW) @ 4000rpm
Maximum torque	400Nm (295 lb.ft.) @ 1750-2500rpm	480Nm (354 lb.ft.) @ 1500rpm
Configuration	4 cylinders, 4 valves per cylinder, double overhead camshafts	4 cylinders, 4 valves per cylinder, double overhead camshafts
Fuel/induction system	Variable geometry turbocharger with intercooler. Common rail fuel injection	Two stage turbocharger with intercooler. Common rail fuel injection
Emission compliance	Euro 6 with Diesel Particulate Filter	Euro 6 with Diesel Particulate Filter
Service interval	20,000 miles or 1 year (whichever occurs sooner)	20,000 miles or 1 year (whichever occurs sooner)

INSIGNIA SPECIFICATIONS

GRAND SPORT PERFORMANCE, FUEL ECONOMY AND EMISSIONS

	Wheel size (inches)	Performance (manufacturer's figures)		Fuel economy mpg (litres/100km) [#]			CO ₂ emissions g/km [#]	Vehicle Excise Duty*		Benefit in kind company car taxation rates – 2017/18 tax year
		Maximum speed (mph)	Acceleration 0-60mph (sec)	Urban driving	Extra-urban driving	Combined figure		First year rate	Standard rate	
Manual										
1.5 (140PS) Turbo ecoTEC	17/18	130	9.3	37.7 (7.5)	57.6 (4.9)	47.6 (5.9)	133	£200	£140	25%
1.5 (165PS) Turbo	17/18	138	8.4	38.7 (7.3)	54.3 (5.2)	47.1 (6.0)	136	£200	£140	26%
1.6 (110PS) Turbo D ecoTEC (with ULRR tyres)	17	127	10.9	61.4 (4.6)	78.5 (3.6)	70.6 (4.0)	105	£140	£140	23%
1.6 (136PS) Turbo D ecoTEC (with ULRR tyres)	17	131	9.9	55.4 (5.1)	72.4 (3.9)	65.7 (4.3)	114	£160	£140	24%
2.0 (170PS) Turbo D	17/18/20	140	8.2	42.2 (6.7)	65.7 (4.3)	54.3 (5.2)	136	£200	£140	29%
Automatic										
1.5 (165PS) Turbo	17/18	135	8.8	37.7 (7.5)	53.3 (5.3)	46.3 (6.1)	138	£200	£140	26%
2.0 (260PS) Turbo 4X4	20	155	6.9	25.2 (11.2)	39.8 (7.1)	32.8 (8.6)	197	£1200	£140	37%
1.6 (136PS) Turbo D	17/18	126	10.2	46.3 (6.1)	62.8 (4.5)	55.4 (5.1)	134	£200	£140	28%
2.0 (170PS) Turbo D	17/18/20	139	8.4	38.2 (7.4)	62.8 (4.5)	51.4 (5.5)	145	£200	£140	31%
2.0 (210PS) BiTurbo D 4X4 (exc. GSi Nav)	20	145	7.4	32.5 (8.7)	49.6 (5.7)	40.9 (6.9)	183	£800	£140	37%
2.0 (210PS) BiTurbo D 4X4 GSi Nav	20	145	7.3	30.7 (9.2)	49.6 (5.7)	40.4 (7.0)	186	£800	£140	37%

SPORTS TOURER PERFORMANCE, FUEL ECONOMY AND EMISSIONS

	Wheel size (inches)	Performance (manufacturer's figures)		Fuel economy mpg (litres/100km) [#]			CO ₂ emissions g/km [#]	Vehicle Excise Duty*		Benefit in kind company car taxation rates – 2017/18 tax year
		Maximum speed (mph)	Acceleration 0-60mph (sec)	Urban driving	Extra-urban driving	Combined figure		First year rate	Standard rate	
Manual										
1.5 (140PS) Turbo ecoTEC	17/18	129	9.6	36.7 (7.7)	57.6 (4.9)	47.1 (6.0)	136	£200	£140	26%
1.5 (165PS) Turbo	17/18	135	8.6	37.2 (7.6)	54.3 (5.2)	46.3 (6.1)	139	£200	£140	26%
1.6 (110PS) Turbo D ecoTEC (with ULRR tyres)	17	125	11.1	56.5 (5.0)	74.3 (3.8)	65.7 (4.3)	112	£160	£140	24%
1.6 (136PS) Turbo D ecoTEC (with ULRR tyres)	17	132	10.1	53.3 (5.3)	70.6 (4.0)	62.8 (4.5)	119	£160	£140	25%
2.0 (170PS) Turbo D	17/18/20	139	8.4	40.9 (6.9)	65.7 (4.3)	53.3 (5.3)	139	£200	£140	29%
Automatic										
1.5 (165PS) Turbo	17/18	133	9.0	36.7 (7.7)	53.3 (5.3)	45.6 (6.2)	141	£200	£140	27%
2.0 (260PS) Turbo 4X4	20	152	7.1	24.6 (11.5)	39.8 (7.1)	32.5 (8.7)	199	£1200	£140	37%
1.6 (136PS) Turbo D ecoTEC (with ULRR tyres)	17	127	10.5	45.6 (6.2)	61.4 (4.6)	54.3 (5.2)	137	£200	£140	29%
2.0 (170PS) Turbo D	17/18/20	137	8.6	37.7 (7.5)	61.4 (4.6)	49.6 (5.7)	150	£200	£140	32%
2.0 (210PS) BiTurbo D 4X4 (exc. GSi Nav)	20	144	7.5	32.1 (8.8)	47.9 (5.9)	40.4 (7.0)	186	£800	£140	37%
2.0 (210PS) BiTurbo D 4X4 GSi Nav	20	144	7.4	30.7 (9.2)	48.7 (5.8)	39.8 (7.1)	187	£800	£140	37%

ULRR = Ultra-low rolling resistance. * = Correct at time of publication.

[#] = Fuel consumption information is official government environmental data, tested in accordance with the relevant EU directive. Official EU-regulated test data is provided for comparison purposes and actual performance will depend on driving style, road conditions and other non-technical factors.

INSIGNIA SPECIFICATIONS

COUNTRY TOURER PERFORMANCE, FUEL ECONOMY AND EMISSIONS

	Wheel size (inches)	Performance (manufacturer's figures)		Fuel economy mpg (litres/100km) [#]			CO ₂ emissions g/km [#]	Vehicle Excise Duty*		Benefit in kind company car taxation rates – 2017/18 tax year
		Maximum speed (mph)	Acceleration 0-60mph (sec)	Urban driving	Extra-urban driving	Combined figure		First year rate	Standard rate	
Manual										
2.0 (170PS) Turbo D	18	137	8.6	39.8 (7.1)	61.4 (4.6)	51.4 (5.5)	145	£200	£140	31%
2.0 (170PS) Turbo D 4X4	18	135	9.3	33.6 (8.4)	52.3 (5.4)	43.5 (6.5)	172	£800	£140	36%
Automatic										
2.0 (170PS) Turbo D	18	135	8.8	37.2 (7.6)	56.5 (5.0)	47.1 (6.0)	157	£500	£140	33%
2.0 (210PS) BiTurbo D 4X4	18	142	7.7	32.1 (8.8)	47.9 (5.9)	39.8 (7.1)	188	£800	£140	37%

* = Correct at time of publication.

= Fuel consumption information is official government environmental data, tested in accordance with the relevant EU directive. Official EU-regulated test data is provided for comparison purposes and actual performance will depend on driving style, road conditions and other non-technical factors.

TRANSMISSION

Six-speed manual gearbox

Petrol engines: 1.5 (140PS) Turbo ecoTEC and 1.5 (165PS) Turbo models

Diesel engines: 1.6 (110/136PS) Turbo D ecoTEC and 2.0 (170PS) Turbo D models

Automatic transmission with ActiveSelect®

Six-speed automatic transmission: Optional at extra cost on 1.5 (165PS) Turbo / 1.6 (136PS) Turbo D models.

Eight-speed automatic transmission: Standard on 2.0 (260PS) Turbo 4X4 / 2.0 (210PS) BiTurbo D 4X4, optional at extra cost on 2.0 (170PS) Turbo D front-wheel drive models.

The latest generation automatic transmissions available on Insignia, incorporating Start/Stop technology, offer improved fuel economy and refinement over previous versions. On the road, a wide selection of shift patterns is adapted to the style and habits of the driver, anticipating when maximum acceleration or maximum efficiency is required. The electronic control will also adapt to the prevailing road conditions, reducing gear shifting when climbing or descending and using engine braking assistance during down changes.

The ActiveSelect® manual mode allows the gear lever to be used like a sequential manual gearbox – you simply push the lever forward or back to change up or down the gears. The eight-speed transmission includes a range of driver-selectable modes.

Four-wheel drive system

Standard on Elite Nav 2.0 (260PS) Turbo 4X4 / 2.0 (210PS) BiTurbo D 4X4, GSi Nav and Country Tourer 4X4 models. The sophisticated four-wheel drive system replaces the conventional rear axle differential with two electronically controlled clutches which allows Insignia to take advantage of the latest torque vectoring technology. This ensures that torque is directed to the wheels with the greatest grip, thus improving handling in all conditions and traction in slippery conditions.

FUEL TANK CAPACITY

62 litres (13.6 gallons)

ADBLUE TANK CAPACITY

15 litres (3.3 gallons)

INSURANCE GROUPS

	Design/ Design Nav	SRI/ SRI Nav	SRI VX-Line Nav	Tech Line Nav	Elite Nav	GSi	Country Tourer
1.5 (140PS) Turbo	14E	–	–	–	–	–	–
1.5 (165PS) Turbo	16E	17E	17E	17E	17E	–	–
2.0 (260PS) Turbo	–	–	–	–	26E	27E	–
1.6 (110PS) Turbo D	13E	14E	–	14E	16E	–	–
1.6 (136PS) Turbo D	15E/16E	16E	16E	16E	18E	–	–
2.0 (170PS) Turbo D	20E	20E	21E	21E	23E	–	20E
2.0 (210PS) BiTurbo D	–	–	–	–	27E	28E	24E

INSIGNIA SPECIFICATIONS

WEIGHTS AND TOWING DATA kg

	Gross vehicle weight			Maximum towing weights Trailer with brakes (without brakes)		
	Grand Sport	Sports Tourer	Country Tourer	Grand Sport	Sports Tourer	Country Tourer
1.5 (140PS) Turbo ecoTEC	2015	2080	–	1405 (700)	1405 (730)	–
1.5 (165PS) Turbo	2015	2085	–	1405 (700)	1405 (730)	–
1.5 (165PS) Turbo automatic	2040	2110	–	1405 (700)	1405 (730)	–
2.0 (260PS) Turbo 4X4 automatic	2245	2295	–	2200 (750)	2200 (750)	–
1.6 (110PS) Turbo D ecoTEC	2035	2125	–	1405 (720)	1405 (750)	–
1.6 (136PS) Turbo D ecoTEC	2070	2140	–	1405 (730)	1405 (750)	–
1.6 (136PS) Turbo D automatic (inc. Sports Tourer ecoTEC)	2095	2165	–	1300 (730)	1300 (750)	–
2.0 (170PS) Turbo D	2185	2240	2240	1950 (750)	1950 (750)	1950 (750)
2.0 (170PS) Turbo D automatic	2220	2270	2270	1700 (750)	1700 (750)	1700 (750)
2.0 (170PS) Turbo D 4X4	–	–	2330	–	–	2200 (750)
2.0 (210PS) BiTurbo D 4X4	2340	2390	2380	1805 (750)	1805 (750)	1805 (750)

Gross vehicle weight is the total permissible weight of the vehicle including passengers and their luggage. The maximum roof rack loading should not exceed 100kg on all models. The maximum towing weights are based on the ability of the car, with two occupants of 75kg each, to restart on a 12% gradient, which is approximately 1 in 8.3, at sea level. The permitted trailer load applies up to the specified incline and up to an altitude of 1000 metres above sea level. The permissible gross train weight decreases by 10% for every 1000 metres of additional altitude. Any extra weight, such as luggage or additional passengers, should be deducted from the maximum towing weight. With a trailer fully loaded, maximum noseweight should not exceed 60kg (75kg on Sports Tourer models, 90kg on 2.0 (260PS) Turbo 4X4, 2.0 (170PS) Turbo D and 2.0 (210PS) BiTurbo 4x4 models). Always fit Vauxhall towing attachments and accessories available from your Vauxhall Retailer. They are designed specifically for Vauxhall models and carry a 12-month guarantee. During trailer towing do not exceed a maximum speed of 60mph. This speed limit is also applicable in countries with higher permitted speeds for trailer-vehicle combinations. Pay attention to the local speed limits. For trailers with low driving stability and caravans the use of an oscillation damper is strongly recommended.

SUSPENSION

Front: Independent. Lightweight MacPherson struts with gas-pressure dampers and coil springs. Anti-roll bar.

Rear: Lightweight multi-link (FWD - 4-link; 4X4 – 5-link) with rising-rate mini-block coil springs and gas-pressure dampers. Anti-roll bar.

- GSi Nav models feature an uprated sports chassis with lower ride height and specially tuned dampers

FlexRide (Adaptive Stability Technology) system

FlexRide offers drivers the choice of three distinct driving modes – Normal (default setting), Sport or Tour. GSi Nav models include a fourth, unique, Competition mode.

- Sport mode: This stiffens the car's suspension and sharpens steering and throttle responses. It also raises the threshold at which the ESP and traction control systems are activated, enhancing dynamic performance

- Tour mode: Ideal for long motorway journeys, the Tour mode adjusts the dampers to a softer setting to create a perceptibly smoother ride and further enhance Insignia's ride comfort

- Continuous damping control: Utilises data from up to 11 variables including acceleration, braking and cornering to constantly control the suspension for optimum stability, driver engagement and comfort. Operates in all three driving modes

BODY

Aerodynamic drag co-efficient:
Cd 0.26

STEERING

- Speed-sensitive electric power-assisted steering
- Turning circle (kerb-to-kerb):
– 11.15m (36.6ft.)

BRAKING AND STABILITY

- Electronic Stability Programme (ESP)
- Cornering brake control
- Straight line stability control
- Rollover mitigation
- Drag torque control
- Hill start assist
- Anti-lock Braking System (ABS)
- Emergency brake assist
- Fading brake support
- Electronic brakeforce distribution
- Adaptive brake lights

1.5 (140PS/165PS) Turbo

Front ventilated discs: 300mm diameter
Rear discs: 288mm diameter

1.6 (110PS) Turbo D

Front ventilated discs: 300mm diameter
Rear discs: 288mm diameter

1.6 (136PS) Turbo D

Front ventilated discs: 321mm diameter
Rear discs: 288mm diameter

2.0 (260PS) Turbo 4X4

Front ventilated discs: 345mm diameter
Rear ventilated discs: 315mm diameter

2.0 (170PS) Turbo D

Front ventilated discs: 321mm diameter
Rear ventilated discs: 315mm diameter

2.0 (170PS) Turbo D 4X4

Front ventilated discs: 321mm diameter
Rear ventilated discs: 315mm diameter

2.0 (210PS) BiTurbo D 4X4 (excluding GSi Nav)

Front ventilated discs: 321mm diameter
Rear ventilated discs: 315mm diameter

2.0 (210PS) BiTurbo D 4X4 GSi Nav

Front ventilated discs: 345mm diameter
Rear ventilated discs: 315mm diameter

INSIGNIA SPECIFICATIONS

EXTERIOR DIMENSIONS millimetres (inches)

Grand Sport

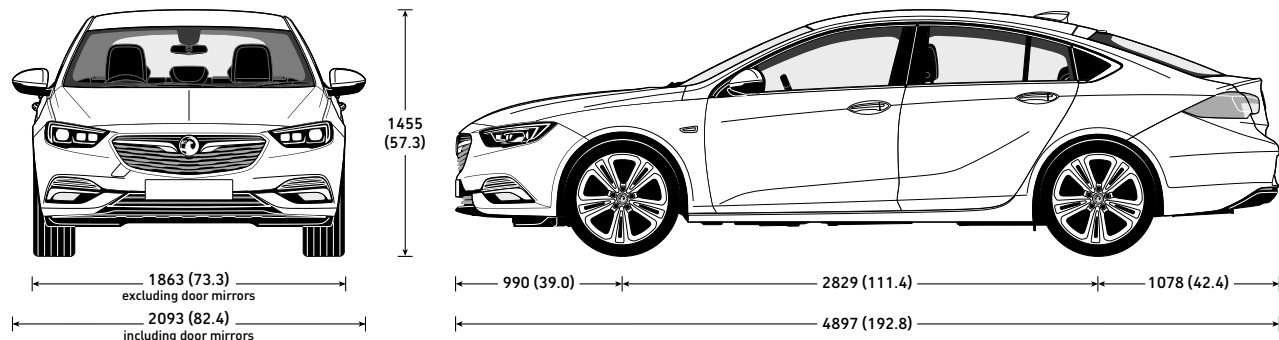

Sports Tourer

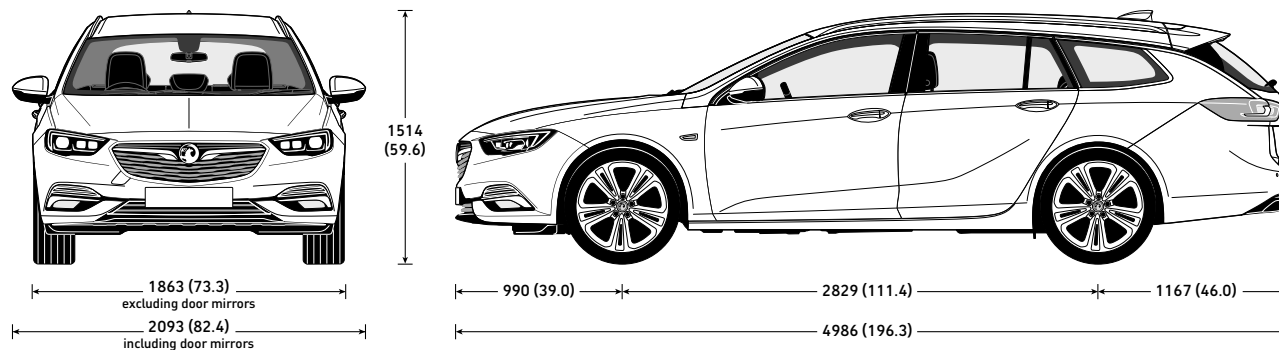

Country Tourer

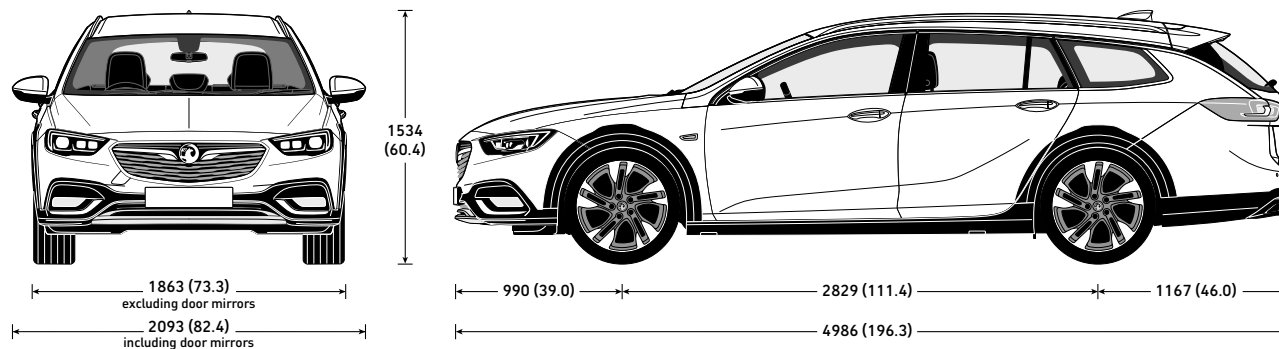

LOADSPACE DIMENSIONS mm (inches)

	Grand Sport	Sports Tourer
Load floor length (rear seats folded)	1940 (76.4)	2005 (78.9)
Load floor length (behind rear seats)	1133 (44.6)	1178 (46.3)
Load area width	1030 (40.5)	1030 (40.5)
Load area height	722 (28.4)	794 (31.2)
Tailgate aperture height	557 (21.9)	711 (28.0)

LOADSPACE CAPACITIES* litres (cu.ft.)

	Grand Sport	Sports Tourer
Rear seat up (under luggage compartment cover)	490 (17.3)	560 (19.8)
Rear seat down (measured to roof)	1450 (51.1)	1665 (58.8)

* = Measured using the ECIE method. When an optional spare wheel is specified loadspace capacity is reduced due to a raised luggage compartment floor.

INSIGNIA OFFERS IN DETAIL – TERMS AND CONDITIONS

Unless otherwise stated, all offers described are available on orders or registrations between 6 March 2018 – 2 April 2018. Offer prices quoted are correct at the time of publication (March 2018). Prices are subject to change. In line with Vauxhall's policy of price transparency, the offer price shown is an on-the-road price including VAT, number plates and delivery to Retailer of £700.00 (including £116.67 VAT), 12 months' Government Vehicle Excise Duty (variable depending upon model) and the DVLA's new vehicle first registration fee of £55.00. Excludes fuel and insurance. Offers may not apply to Retailer stocks and are subject to availability. Restrictions may apply. Contact your Retailer for details. Vauxhall Motors Limited reserves the right to change, amend or withdraw these offers at any point in time.

0% FLEXIBLE FINANCE

Available on selected models only. Conditional Sale. Finance subject to status, Ts&Cs apply. 18+ Finance by Vauxhall Finance, CF15 7YT. 24-60 month term. Offer applies to private individuals, Vauxhall Partners and small businesses 1-24 units (purchase only excluding B2B supported units). All other customers are excluded. Offers available on orders and registrations between 6 March – 2 April 2018. Vauxhall Motors Limited reserves the right to change, amend or withdraw this offer at any point in time. Offer not available in conjunction with Personal Contract Hire, Flexible PCP or a deposit contribution.

FLEXIBLE PCP

Offer subject to availability at participating Retailers only. Personal Contract Purchase. Finance subject to status. Terms and Conditions apply. Applicants must be 18+. Finance by Vauxhall Finance, CF15 7YT. 24-48 month term available. Vauxhall deposit contribution only available when vehicle financed through Vauxhall Finance. At the end of the agreement there are three options: i) Pay the optional final payment to own the vehicle, ii) Return the vehicle, or iii) Replace: Part Exchange the vehicle, where equity is available. UK-supplied vehicles only. Offer applies to private individuals, Vauxhall Partners and small businesses 1-24 units (purchase only excluding B2B supported units). Offer not available in conjunction with Personal Contract Hire, 0% Flexible Finance or a deposit contribution.

PERSONAL CONTRACT HIRE

Personal contract hire offer on vehicles ordered by 2 April 2018 subject to availability and status. Age 18+ only. Figures based on a non-maintenance contract hire package. Excess miles over contracted mileage of 24,000 over 36 months charged at a maximum of 14 pence per mile. Excess charges also apply if you breach manufacturer servicing or maintenance guidelines or if the car exceeds BVRLA Fair Wear & Tear guidelines for its age/mileage when it is returned to Vauxhall Leasing. Package includes Road Fund Licence and Vauxhall Assistance. Guarantee/indemnity may be required. Prices and details are subject to change without notice. For full specification and Ts&Cs contact your local Retailer. You will not own the car. ALD Automotive Ltd., trading as Vauxhall Leasing, BS16 7LB. Authorised and regulated by the Financial Conduct Authority. Offer not available in conjunction with 0% Flexible Finance, Flexible PCP or a deposit contribution.

Please note not all offers apply to all models.

INSIGNIA COMPANY CAR DRIVER/FLEET INFORMATION

DESIGN AND TECH LINE HIGH SPEC, LOW P11D

Specifically developed for businesses and company car drivers alike, our Design and Tech Line models are seriously fit for Fleet.

Design models all feature very low P11D values, generous standard specification with a choice of high tech ecoTEC engines for great fuel economy and low emissions including the 'whisper diesel' 1.6CDTi (from 88g/km and 85.6mpg combined).

For even more standard specification, step up to our Tech Line range again you are guaranteed low P11D values, plus great standard kit including Sat Nav, Bluetooth®, USB connection and digital radio.

With Design and Tech Line you can take for granted low Whole Life Costs and low company car driver taxation.



COMPANY CAR DRIVER FREE* 3 DAY TEST DRIVE

Our free* 3 Day Test Drive programme is open to all Company Car Drivers which allows you to choose any model in the current Vauxhall line-up (excluding Cascada, all VXR models and Commercial Vehicles), with full insurance cover provided, to give you a meaningful length of time to make an informed decision about your next company car.

Click below to book your free* test drive
www.vauxhall3dtd.co.uk
 or call 0330 587 8221**

*The free 3 Day Test Drive programme is open to Company Car Drivers and Fleet Decision Makers. Available for UK Mainland only. Terms and conditions apply. Full terms and conditions can be found at vauxhallfleet.co.uk/testdrive/index/terms. **Telephone lines open Monday-Friday 9.00am to 5.00pm excluding Bank Holidays. Calls may be recorded or monitored for quality and/or training purposes

BENEFIT IN KIND COMPANY CAR TAXATION†

The car benefit charge will be the car's list price (including VAT, options and accessories fitted, delivery to Retailer and number plates, but excluding Vehicle Excise Duty and new vehicle first registration fee) multiplied by the percentage charge for the CO₂ emissions band in which the car falls (see table opposite). Multiply this figure by your personal income tax rate (20% for Basic Rate, 40% for Higher Rate) to calculate your annual benefit in kind tax liability.

Example:

Insignia Tech Line Nav 1.6 (110PS) Turbo D ecoTEC Grand Sport (CO ₂ emissions 105g/km)	
On-the-road RRP	£21670.00
Deduct: Vehicle Excise Duty	(£140.00)
New vehicle first registration fee	(£55.00)
Effective list price	£21475.00
Add: Optional two-coat metallic paint	£565.00
List price for tax purposes (P11D value)	£22040.00
Car benefit charge	
2017-18 tax year (23%)	£5069.00
Benefit in kind tax liability (2017-18 tax year)	
Basic Rate (20%) tax payer	£1013.80
Higher Rate (40%) tax payer	£2027.60

† = Please note this Price Guide provides taxation information as a guide only. Vauxhall does not provide taxation guidance. Drivers should always take professional advice on their own tax position.

CO ₂ emissions in grams per kilometre	Percentage of car's price to be taxed	
	Petrol 2017-18 tax year	Diesel 2017-18 tax year
up to 50	9	12
51-75	13	16
76-94	17	20
95-99	18	21
100-104	19	22
105-109	20	23
110-114	21	24
115-119	22	25
120-124	23	26
125-129	24	27
130-134	25	28
135-139	26	29
140-144	27	30
145-149	28	31
150-154	29	32
155-159	30	33
160-164	31	34
165-169	32	35
170-174	33	36
175-179	34	37
180-184	35	37
185-189	36	37
190 and above	37	37

To calculate your own personal liability a car tax calculator is available at:
<https://www.vauxhallfleet.co.uk/toolbox>

FLEET TOOLBOX

Discover the facts in our online Toolbox for both Company Car Drivers and Fleet Decision Makers. The Fleet Toolbox has a host of useful calculators, comparators, interactive listings and information. Visit the Fleet Toolbox by going to www.vauxhall-toolbox.co.uk



ROADTRIP APP

The Vauxhall RoadTrip App is a free app that calculates and logs your mileage expenses for any UK business trips and generates reports to help you complete your mileage claims. Available for both iPhone and Android, visit www.vauxhall-toolbox.co.uk or visit the iPhone or Android stores and search for Vauxhall RoadTrip to download it to your smartphone or tablet.



CONTACT VAUXHALL FLEET

Please contact one of our dedicated sales teams who will be happy to help with your particular enquiry.

Company Car Drivers

Call: 0345 111 2020
 Email: company-car@vauxhallinfo.co.uk

Telephone lines are open
 – Monday to Friday 8.00am-9.00pm
 – Saturday and Sunday 9.00am-6.00pm

Fleet Decision Makers

Depending on the size of your fleet of vehicles, we have a dedicated team to handle your enquiries. The lines are open Monday to Friday excluding Bank Holidays.

1-24 vehicles

Call: 0845 076 2254 (8.30am-5.00pm)
 Email: b2bsales@vauxhall.co.uk

25+ vehicles

Call: 0330 587 8222 (8.30am-5.00pm)
 Email: vauxhallfleet@vauxhall.co.uk

Special Vehicles (Police, Fire and Ambulance)

Call: 01582 409999 (8.30am-5.00pm)
 Email: vauxhallspecialvehicles@vauxhall.co.uk

INSIGNIA ADDITIONAL INFORMATION

ON-THE-ROAD PRICES

To eliminate uncertainty about hidden costs when buying a new car, Vauxhall publishes on-the-road recommended retail prices (RRP) and these are shown in the pricing tables within this price guide. These prices include VAT, number plates and delivery to Retailer of £700.00 (including £116.67 VAT), 12 months' Government Vehicle Excise Duty (see opposite for details) and the DVLA new vehicle first registration fee of £55.00*.

Please note: The on-the-road recommended retail price (RRP) does not include fuel supplied by the Retailer, motor insurance or any other goods or services supplied by agreement between the Retailer and the customer.

PRICE PROTECTION

Order a new Vauxhall for build in the current model year (as confirmed by your Retailer) for delivery no more than three months in advance and the price you are quoted is the price you pay. This is irrespective of any subsequent price rises between placing your order and delivery of your new car, but you must take delivery as soon as the car is available. Vauxhall Motors Limited is not liable for price adjustments caused by Government changes in the rate of VAT (currently 20%), Vehicle Excise Duty, DVLA new vehicle first registration fee or by any other applicable legislation or regulations.

VEHICLE EXCISE DUTY

The amount of Vehicle Excise Duty (road fund licence) payable on new cars varies depending on the level of carbon dioxide (CO₂) emissions produced by the vehicle. CO₂ emissions are measured in grammes (g) per kilometre (km) travelled and divided into 13 charging bands shown in the table below.

A 'first year rate' of Vehicle Excise Duty is payable on all new cars and in subsequent years the amount payable reverts to the 'standard rate'. From 1 April 2017 the breakpoints for each of these bands have been revised. Also, for vehicles with a list price over £40,000, including factory-fitted options, an additional £310 is payable for the first five years of standard rate payments.

Vehicle Excise Duty*

	CO ₂ emissions (g/km)	First year rate	Standard rate
Band A	0	£0.00	£0.00
Band B	1-50	£10.00	£140.00
Band C	51-75	£25.00	£140.00
Band D	76-90	£100.00	£140.00
Band E	91-100	£120.00	£140.00
Band F	101-110	£140.00	£140.00
Band G	111-130	£160.00	£140.00
Band H	131-150	£200.00	£140.00
Band I	151-170	£500.00	£140.00
Band J	171-190	£800.00	£140.00
Band K	191-225	£1200.00	£140.00
Band L	226-255	£1700.00	£140.00
Band M	over 255	£2000.00	£140.00

* = Correct at time of issue.

VAUXHALL LEASING

As Vauxhall's own contract hire and fleet management operation, Vauxhall Leasing provides a one-stop-shop for competitive car and van leasing solutions – for business users and private individuals. Working with the Vauxhall Retailer network, we combine the support of a national contract with the convenience of a local contact.

For further information, please see your local Vauxhall Retailer or call us on **0117 908 6433**. Alternatively, you can visit our website at www.vauxhall-leasing.co.uk

IN THE EVENT OF AN ACCIDENT...

Vauxhall Accident Management helps keep you mobile following an accident. Benefits include vehicle recovery, Vauxhall-approved repairs and contacting your insurer. For more details, visit vauxhall.co.uk/AccidentManagement

TRUST VAUXHALL

CUSTOMER CARE COMMITMENT

For added peace of mind, Vauxhall has an innovative Customer Care Commitment that offers the following:

- Three-year vehicle warranty consisting of a one-year/unlimited mileage manufacturer's warranty and a second and third year manufacturer's warranty with a 60,000 miles limitation
- Vauxhall Assistance for 12 months from first registration
- Six years' body panel anti-perforation warranty

Please note: Warranty is only available on vehicles sourced from Vauxhall Motors Limited. Terms and conditions apply – please see your Vauxhall Retailer for details.

VAUXHALL ASSISTANCE

Vauxhall Assistance is provided automatically with every new Vauxhall for 12 months from first registration and covers everything from accident assistance, roadside recovery and 'at home' service to flat tyres. With Vauxhall Assistance help is literally just a free* phone call away, 24 hours a day, 365 days a year!

* = Mobile phone users will be charged at their standard tariff.

PROTECTING THE ENVIRONMENT

Vauxhall's commitment to the environment is demonstrated by our products' many environmental awards. For even more information on Vauxhall's efforts to achieve an environmentally sustainable future, and how to dispose of your end-of-life vehicle, see www.vauxhall.co.uk/recycling

VAUXHALL SERVICE PLAN

- Fixed monthly payments for the plan duration
- Easy to budget and interest-free
- Genuine parts fitted by Vauxhall-trained technicians

Plus on Gold plans:

- Valet and courtesy car
- Full AA cover
- Engine flush and fuel treatments
- Litre of oil for top ups between services

Full details can be obtained from your local participating Vauxhall Retailer.

VAUXHALL INSURANCE WITH ADDED REASSURANCE

Comprehensive cover – Summary of benefits**

- Competitive premiums
- Repairs by a Vauxhall-trained technician
- Genuine Vauxhall parts, guaranteed for three years when we repair your car within our Approved Repairer Network
- Free courtesy car as standard when using an Approved Repairer†
- 24 hour claims helpline
- Personal Accident benefit
- Cover for audio equipment
- Windscreen cover

Call for a quote on 0844 463 2670††

** = The benefits listed above are for comprehensive cover only. For details of Third Party, Fire and Theft cover, please call our sales team.
† = Should your car need repairing following an accident we provide a courtesy car (subject to availability) for the duration of the repair. Only genuine Vauxhall parts are used. Terms and conditions apply.
†† = Calls may be recorded. Vauxhall Insurance is underwritten by Ageas Insurance Limited.

FOR MORE PRODUCT INFORMATION

For a brochure on any Vauxhall model (up to a maximum of three per caller) or location of your nearest Vauxhall Retailer please call **0345 600 1500**. Alternatively, details can be found on our website at www.vauxhall.co.uk

JOIN US ONLINE:



PROUD SPONSOR OF OUR NATIONAL FOOTBALL TEAMS



Privacy Policy – For full details please visit: vauxhall.co.uk/privacy

OnStar privacy details are available at vauxhall.co.uk/onstar

The invoice price, including delivery to Retailer, factory-fitted options, accessories fitted by the Retailer and number plates, is subject to VAT. Some feature descriptions in this guide may refer to, and some illustrations may show, optional equipment not included in the standard delivery. The information contained in this guide was accurate at the time of publication. We reserve the right to make changes in design and equipment. Please note that Vauxhall Retailers are not the agents of Vauxhall Motors Limited and are not authorised to bind Vauxhall Motors Limited by any specific or implied undertaking or representation. It is advisable to ensure that your motor insurance policy provides adequate cover for additional fitted options and accessories. The colours in this guide are only approximate actual colours. Illustrated optional equipment is available at extra charge. Availability, technical features and equipment provided on our vehicles can vary by model. For precise information on the equipment provided on our vehicles, please contact your local Vauxhall Retailer.

VAUXHALL

vauxhall.co.uk

©2018 Vauxhall Motors Limited

Published 6 March 2018 Vauxhall Motors Limited

THE NEW **INSIGNIA**

PRICE/SPECIFICATION GUIDE

19 December 2017

Pre-current Model Year



VAUXHALL

NEW INSIGNIA PRICES

Model	Price (£)	VAT (£)	Total (£)	On-the-road RRP (£)	CO ₂ (g/km)	Model	Price (£)	VAT (£)	Total (£)	On-the-road RRP (£)	CO ₂ (g/km)
Grand Sport						Grand Sport					
DESIGN						SRI VX-LINE NAV					
1.5 (140PS) Turbo ecoTEC	13900.00	2780.00	16680.00	17635.00	133	1.5 (165PS) Turbo	17329.16	3465.84	20795.00	21750.00	136
1.5 (165PS) Turbo	14150.00	2830.00	16980.00	17935.00	136	<i>Diesel</i>					
<i>Diesel</i>						1.6 (136PS) Turbo D ecoTEC**	18745.83	3749.17	22495.00	23410.00	114
1.6 (110PS) Turbo D ecoTEC	15150.00	3030.00	18180.00	19075.00	105	1.6 (136PS) Turbo D auto	20079.16	4015.84	24095.00	25050.00	134
1.6 (136PS) Turbo D ecoTEC	15566.66	3113.34	18680.00	19595.00	114	2.0 (170PS) Turbo D BlueInjection*	19412.50	3882.50	23295.00	24250.00	136
DESIGN NAV						TECH LINE NAV					
1.5 (140PS) Turbo ecoTEC	14562.50	2912.50	17475.00	18430.00	133	1.5 (165PS) Turbo	16312.50	3262.50	19575.00	20530.00	136
1.5 (165PS) Turbo	14812.50	2962.50	17775.00	18730.00	136	<i>Diesel</i>					
SRI						ELITE NAV					
1.5 (165PS) Turbo	15650.00	3130.00	18780.00	19735.00	136	1.5 (165PS) Turbo	18504.16	3700.84	22205.00	23160.00	136
<i>Diesel</i>						2.0 (260PS) Turbo 4X4 auto	22420.83	4484.17	26905.00	28860.00	197
1.6 (110PS) Turbo D ecoTEC	16650.00	3330.00	19980.00	20875.00	105	<i>Diesel</i>					
SRI NAV						ELITE NAV					
1.5 (165PS) Turbo	16312.50	3262.50	19575.00	20530.00	136	1.6 (136PS) Turbo D ecoTEC**	19920.83	3984.17	23905.00	24820.00	114
<i>Diesel</i>						1.6 (136PS) Turbo D auto	21254.16	4250.84	25505.00	26460.00	134
1.6 (110PS) Turbo D ecoTEC	17312.50	3462.50	20775.00	21670.00	105	2.0 (170PS) Turbo D BlueInjection*	20587.50	4117.50	24705.00	25660.00	136
1.6 (136PS) Turbo D ecoTEC	17729.16	3545.84	21275.00	22190.00	114	2.0 (170PS) Turbo D auto BlueInjection*	21920.83	4384.17	26305.00	27260.00	145
2.0 (170PS) Turbo D BlueInjection*	18395.83	3679.17	22075.00	23030.00	136						

Please note: On-the-road recommended retail prices (RRP) include number plates and delivery to Retailer of £700.00 (inc. £116.67 VAT) 12 months' Vehicle Excise Duty and new vehicle first registration fee of £55.00. Excludes fuel and insurance.

* = Please note: Vehicles with BlueInjection technology will need regular AdBlue® top-ups also between servicing requirements.

An indicator integrated into the on-board computer will warn you when you need to top up. More information under www.vauxhall.co.uk/discover-vauxhall/technology/adblue.html

In accordance with regulations R (EC) No. 715/2007 and R (EC) No. 692/2008 (in the versions respectively applicable).

** = Fitted with 17-inch alloy wheels. Optional alloy wheels are not available.

NEW INSIGNIA PRICES

Model	Price (£)	VAT (£)	Total (£)	On-the-road RRP (£)	CO ₂ (g/km)
Sports Tourer					
DESIGN					
<i>Diesel</i>					
2.0 (170PS) Turbo D BlueInjection*	17483.33	3496.67	20980.00	21935.00	139
SRI VX-LINE NAV					
1.5 (165PS) Turbo	18579.16	3715.84	22295.00	23250.00	139
<i>Diesel</i>					
2.0 (170PS) Turbo D BlueInjection*	20662.50	4132.50	24795.00	25750.00	139
2.0 (170PS) Turbo D auto BlueInjection*	21995.83	4399.17	26395.00	27350.00	150
ELITE NAV					
2.0 (260PS) Turbo 4X4 auto	23670.83	4734.17	28405.00	30360.00	199
<i>Diesel</i>					
1.6 (110PS) Turbo D ecoTEC**	20754.16	4150.84	24905.00	25820.00	112
2.0 (170PS) Turbo D BlueInjection*	21837.50	4367.50	26205.00	27160.00	139

Please note: On-the-road recommended retail prices (RRP) include number plates and delivery to Retailer of £700.00 (inc. £116.67 VAT) 12 months' Vehicle Excise Duty and new vehicle first registration fee of £55.00. Excludes fuel and insurance.

* = Please note: Vehicles with BlueInjection technology will need regular AdBlue® top-ups also between servicing requirements.

An indicator integrated into the on-board computer will warn you when you need to top up. More information under www.vauxhall.co.uk/discover-vauxhall/technology/adblue.html

In accordance with regulations R (EC) No. 715/2007 and R (EC) No. 692/2008 (in the versions respectively applicable).

** = Fitted with 17-inch alloy wheels. Optional alloy wheels are not available.

Model	Price (£)	VAT (£)	Total (£)	On-the-road RRP (£)	CO ₂ (g/km)
Country Tourer					
COUNTRY TOURER					
<i>Diesel</i>					
2.0 (170PS) Turbo D auto BlueInjection*	21900.00	4380.00	26280.00	27535.00	157

Please note: On-the-road recommended retail prices (RRP) include number plates and delivery to Retailer of £700.00 (inc. £116.67 VAT) 12 months' Vehicle Excise Duty and new vehicle first registration fee of £55.00. Excludes fuel and insurance.

* = Please note: Vehicles with BlueInjection technology will need regular AdBlue® top-ups also between servicing requirements.

An indicator integrated into the on-board computer will warn you when you need to top up. More information under www.vauxhall.co.uk/discover-vauxhall/technology/adblue.html

In accordance with regulations R (EC) No. 715/2007 and R (EC) No. 692/2008 (in the versions respectively applicable).

NEW INSIGNIA FEATURES/OPTIONS

SAFETY

Driver / passenger airbags

- Driver's airbag • Front passenger's airbag • Two front seat side-impact airbags
- Full-size curtain airbags for driver and front and outer rear seat passengers

Seating

- Height-adjustable front seat head restraints • Three height adjustable rear seat head restraints
- Anti-submarining ramps in front seats – Prevents occupants sliding underneath the lap belt during a collision.

Seatbelts

- Height adjustable front inertia-reel lap and diagonal seatbelts • Three inertia-reel lap and diagonal rear seatbelts • Front and outer rear seatbelt pretensioner system – Pretensioners tighten the seatbelt in the event of an accident limiting forward movement • Front and outer rear seatbelt force limiters – Reduces potential upper body injuries during a frontal impact.
- Front 'seatbelt unfastened' audible warning and warning light

Child safety

- Deactivation switch for front passenger's front and side-impact airbags – Permits the safe use of a child seat in the front passenger seat • ISOFIX child seat mountings incorporating top tether anchor points located on outer rear seats (does not include child seat) – Allows ISOFIX child safety seats to be securely fixed into the car. The ISOFIX mounting system reduces forward movement in an accident and makes the child seat easier to install. • Child-proof locks on rear doors

Driver / passenger safety

- Energy-absorbing steering column • Pedal release system – Reduces potential injury to the driver's legs and feet during a severe frontal impact. • Laminated windscreen • Side-impact protection beams • Reinforced passenger safety cell • Deformation zones front and rear
- Burst-proof door locks and anti-jam door design

Pedestrian safety

- Active bonnet / headlight / wiper structure – Designed to reduce pedestrian head and upper body injuries. The active bonnet travels backwards and upwards to help prevent impact between pedestrian's head and underbonnet components.
- Upper and lower bumper design – Reduces upper and lower leg injuries.

Stability

Electronic Stability Programme (ESP):

– Works in conjunction with the vehicle's electronic braking and engine systems to keep the car stable in many different situations. ESP monitors many different inputs to determine when the car starts to lose traction, it can then immediately respond by varying the brake pressure between up to three wheels and adjust the engine output to help correct the loss of traction and improve stability.

Additional ESP features:

- Traction control • Cornering brake control • Straight line stability control • Rollover mitigation • Drag torque control – Maintain stability on slippery roads when lifting off the accelerator or changing gear.

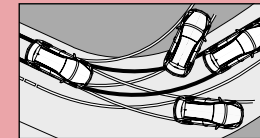

Braking

Anti-lock Braking System (ABS):

– Prevents the vehicle's wheels from locking up under heavy braking by momentarily reducing brake pressure at the appropriate wheel, ensuring that you can maintain control of the steering.

Additional braking features:

- The same electronic systems used in the ABS and ESP also deliver exceptional braking performance.
- Emergency brake assist – When emergency braking is detected the vehicle automatically applies the maximum possible braking assistance. • Fading brake support – Compensates for the effects of brake fade • Electronic brakeforce distribution – Automatically apportions the optimum braking force to each wheel. • Adaptive brake lights – Automatically warns other road users of heavy braking
- Hill start assist – Briefly maintains rear brake pressure to stop the vehicle rolling back on an incline.
- Hazard warning lights

Tyre pressure







- Tyre pressure monitoring system

NEW INSIGNIA FEATURES/OPTIONS

	Design / Design Nav	SRI / SRI Nav	SRI VX-Line Nav	Tech Line Nav	Elite Nav	Country Tourer	Price (£) exc. VAT	Total (£) inc. VAT
DRIVER ASSISTANCE								
Electric parking brake • Centre console switch in lieu of handbrake lever • Premium centre console featuring adjustable armrest	●	●	●	●	●	●		
Steering • Speed-sensitive electrically assisted power steering	●	●	●	●	●	●		
Cruise control with speed limiter <i>Cruise control enables you to maintain a constant speed – making it ideal for economical motorway driving. The speed limiter function can be set to ensure that you do not exceed the speed limit and can be easily overridden if required.</i> • Steering wheel mounted controls	●	●	●	●	●	●		
FlexRide (available at extra cost on 1.6 (136PS) Turbo D and 2.0 (170PS) Turbo D models, standard on 2.0 (260PS) Turbo 4X4 models) <i>Enables the driver to choose from three distinct driving modes – Normal (default setting), Sport or Tour.</i> • Facia mounted Sport and Tour switches	○	○	○	○	○	●	666.67	800.00

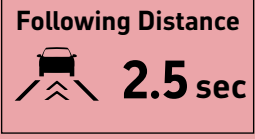





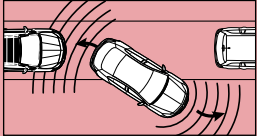

● = Standard equipment. ○ = Optional at extra cost.

NEW INSIGNIA FEATURES/OPTIONS

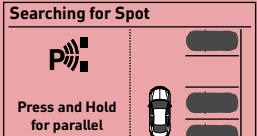
DRIVER ASSISTANCE		Design / Design Nav	SRI / SRI Nav	SRI VX-Line Nav	Tech Line Nav	Elite Nav	Country Tourer	Price (£) exc. VAT	Total (£) inc. VAT
Driving Assistance Pack One A wide range of class-leading driver assistance and safety features are controlled by the front camera system Forward collision alert with automatic city emergency braking: In certain circumstances and at speeds above 5mph warns when approaching another vehicle too quickly. At speeds above 5mph and up to 50mph the system provides additional braking support to help the driver brake more quickly and effectively in an emergency situation. On dry roads at speeds above 5mph and up to 25mph the vehicle can brake to a full stop. At speeds above 25mph and up to 50mph, if no avoiding action is taken by the driver, the system automatically slows the vehicle with emergency braking. • Visual warnings – red LEDs projected onto windscreen and visual warning shown in the instrument cluster • Audible warning • Additional braking support • Low speed collision mitigation braking 									
 Warns you of potential accidents									
Following distance indicator: Indicates how many seconds you are behind the vehicle in front – helping you maintain a safe distance. • Timings are shown in the driver information display • Warning light in the instrument cluster if the gap to the vehicle ahead is below that set by the driver 		●	●	●	●	●	●		
 Keeps a safe distance									
Lane departure warning with lane assist: If the driver has not actively steered or signalled, the lane departure warning system warns when the car moves outside of lane markings at speeds above 35mph. The lane assist function additionally provides gentle steering correction to help drivers keep in their lane if no active inputs are made. • Warning light in the instrument cluster • Audible warning • Steering wheel 'hudge' warning • Facia on / off switch 									
 Keeps you in lane									
Driving Assistance Pack Two – Automatic cruise control incorporating automatic brake intervention Automatic cruise control adjusts the vehicle's speed to maintain a time distance to the preceding vehicle, up to the speed that you have set. On models with automatic transmission the 'Stop and Go' function will bring the vehicle to a complete stop and then set off again as the traffic ahead moves away. Automatic brake intervention is active at all speeds above walking pace (2.5mph).			○	○	○	○	○	400.00	480.00

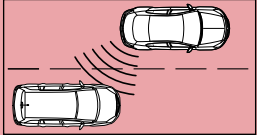
● = Standard equipment. ○ = Optional at extra cost.

NEW INSIGNIA FEATURES/OPTIONS

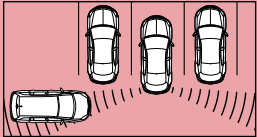
		Design / Design Nav	SRI / SRI Nav	SRI / VX-Line Nav	Tech Line Nav	Elite Nav	Country Tourer	Price (£) exc. VAT	Total (£) inc. VAT
DRIVER ASSISTANCE									
Front and rear parking distance sensors (not available with Driving Assistance Pack Four) • Audible warning • Distance warning graphic shown in driver information display 		○	○	○	●	●	●	383.33	460.00
 Easier parking									
Rear-view camera (not available with Driving Assistance Pack Four)		○	○	○	○	○	○	258.33	310.00
Driving Assistance Pack Four (only available on Nav models. Design Nav models require optional Sight and Light Pack. Includes front and rear parking distance sensors. Not available with Brownstone Nappa premium leather) <i>Intelligent ultrasonic sensors form part of the solution for today's crowded roads and car parks – delivering exceptional assistance both when parking and protecting you on the open road.</i> • Electrically foldable door mirrors with puddle lights Advanced park assist: <i>Advanced park assist not only detects suitable parking spaces but also expertly steers into them for you. All you have to do is to drive forward or reverse. The system works with both parallel and bay parking.</i> • Ultrasonic side sensors with four-metre range • Ultrasonic front and rear parking sensors with a two-metre range • Fully automated steering • On automatic models, braking is automated • Detailed forward/reverse instructions are shown in the instrument cluster or central facia display 									
 Finds suitable parking spaces									
 Auto steers into the parking space for you									
Lane change assist with side blind spot alert: <i>Lane change assist with side blind spot alert helps prevent potential collisions with other vehicles 'hidden' in the vehicle's side blind spots. If a vehicle enters one of the blind spots a warning light illuminates in the relevant door mirror.</i> • Ultrasonic side sensors identify vehicles within three-metre range • LED warning light in door mirrors, flashes when indicators are used • Audible warning is sounded if the indicators are used and the system has detected another vehicle • Radar sensors with 70-metre range identify traffic approaching quickly from behind 		○	○	○	○	○	○	495.83	595.00
 Warns of vehicles in your blind spot									
Rear-view camera: <i>The rear-view camera gives a clear view of the area behind your car and helps place the car perfectly, without needing to strain your neck.</i> • Activated when reverse gear selected • Camera view appears in infotainment screen • Rear bumper and grid lines shown as reference points 									
 See what's behind you on the central screen									
Rear cross traffic alert: <i>As you reverse the car in a tricky parking situation this system detects vehicles approaching from the rear and side.</i> • Radar sensors with 20-metre range identify approaching vehicles • Warning light in central facia display • Audible warning on relevant side of car 									

● = Standard equipment. ○ = Optional at extra cost.

NEW INSIGNIA FEATURES/OPTIONS

	Design / Design Nav	SRI / SRI Nav	SRI VX-Line Nav	Tech Line Nav	Elite Nav	Country Tourer	Price (£) exc. VAT	Total (£) inc. VAT
SECURITY								
Standard security features • Electronically protected audio equipment • Engine deadlock immobiliser • Visible Vehicle Identification Number (VIN) • Locking wheel bolts for alloy wheels • Freewheeling door locks	●	●	●	●	●	●		
Remote control central locking • Operates on doors, tailgate and fuel filler flap • Deadlocking • Central locking activation switch on driver's door • Keyless entry and start with two transmitter fobs and engine start/stop button	●	●	●	●	●	●		
Remote control ultrasonic security alarm system • Remote control (operates in conjunction with central locking) • Ultrasonic interior sensors • Tilt sensor • Independent power supply • Thatcham approved (T1)	●	●	●	●	●	●		
DRIVER INFORMATION								
Instrumentation • Speedometer • Rev counter • Digital fuel gauge with low fuel level warning light • Digital water temperature gauge with warning light • Shift-up/down indication light – <i>Indicates when to change gear for optimum fuel economy.</i>	●	●	●	●	●	●		
Driver information display (centrally located in instrument cluster) Displays: • Trip computer data • Total mileage • Service-due indicator • Oil life • Tyre pressure monitoring system	●	●	●	●	●	●		
• 3.5-inch monochrome display (non-Nav models)	●	●						
• 4.2-inch colour display (Nav models)	●	●	●	●		●		
• 8-inch colour display incorporating speedometer and supplementary audio, phone and navigation information (only available on Nav models)		○	○	○	●	○	345.83	415.00
Head-up display (only available on Nav models, in conjunction with 8-inch colour display) <i>Projects key information onto the windscreen so that the driver's eyes remain on the road at all times. The display is adjustable for height and brightness.</i> Displays: • Navigation directions • Audio and phone information • Speedometer • Rev counter • Selected gear and gear shift indicator • Set speed of cruise control and speed limiter • Forward collision alert • Following distance indicator gap adjustment • Lane assist and lane departure warning • Pedestrian alert Please note: The red LEDs of the forward collision alert system are replaced by a warning symbol		○	○	○	○	○	241.67	290.00
Multi-function trip computer (displayed on driver information display) • Trip mileage • Vehicle range based on remaining fuel • Average speed • Average fuel economy • Instantaneous fuel economy • Driving time	●	●	●	●	●	●		
Central facia display (format dependent on infotainment unit) • Audio information • Digital clock with automatic RDS time adjustment • Outside air temperature with ice warning function • Additional features dependent on infotainment unit (see infotainment for details)	●	●	●	●	●	●		

● = Standard equipment. ○ = Optional at extra cost.

NEW INSIGNIA FEATURES/OPTIONS

	Design / Design Nav	SRI / SRI Nav	SRI VX-Line Nav	Tech Line Nav	Elite Nav	Country Tourer	Price (£) exc. VAT	Total (£) inc. VAT
INTERIOR STYLING Design interior décor Steering wheel: • Three-spoke design • Leather-covered • Satin chrome-effect bezel Facia and door trim: • Black facia • Black door panels with black Atlantis cloth inserts • Metallic silver Raute trim inserts • Chrome-effect interior door handles Headlining: • Light fabric	●							
SRI interior décor Steering wheel: • Three-spoke design • Leather-covered, perforated • Satin chrome-effect bezel Facia and door trim: • Black facia • Silver air vent surrounds • Black door panels with black Morrocana inserts (standard seats); black leather-effect inserts (optional AGR sports seats); Brownstone Nappa leather inserts (optional Brownstone premium leather seats) • Dark metallic Hexagon trim inserts • Chrome-effect interior door handles Pedals: • Sports, alloy-effect Headlining: • Light fabric Front door sill covers: • Alloy-effect		●						
SRI VX-Line Nav interior décor Steering wheel: • Three-spoke VX-Line design, flat bottom • Leather-covered, perforated • Electrically heated • Satin chrome-effect bezel Facia and door trim: • Black facia • Silver air vent surrounds • Black door panels with black Morrocana inserts (standard seats); black leather-effect inserts (optional AGR sports seats); Brownstone Nappa leather inserts (optional Brownstone premium leather seats) • Dark metallic Hexagon trim inserts • Chrome-effect interior door handles Pedals: • Sports, alloy-effect Headlining: • Dark fabric Front door sill covers: • Alloy-effect			●					
Tech Line Nav / Country Tourer interior décor Steering wheel: • Three-spoke design • Leather-covered • Satin chrome-effect bezel Facia and door trim: • Black facia • Black door panels with black leather-effect inserts • Dark silver Agate trim inserts • Chrome-effect interior door handles Headlining: • Light fabric Front door sill covers: • Alloy-effect				●		●		
Elite Nav interior décor Steering wheel: • Three-spoke design • Leather-covered • Satin chrome-effect bezel Facia and door trim: • Black facia • Silver air vent surrounds • Black door panels with black leather-effect inserts (standard and optional black leather AGR sports seats); shale leather-effect inserts (optional shale leather AGR sports seats); Brownstone Nappa leather inserts (optional Brownstone premium leather seats) • Dark silver Agate trim inserts • Chrome-effect interior door handles Headlining: • Light fabric Front door sill covers: • Alloy-effect					●			
VXR Interior Pack Steering wheel: • Three-spoke VX-Line design, flat bottom • Leather-covered, perforated • Electrically heated • Satin chrome-effect bezel • Paddle shift on automatic models Pedals: • Sports, alloy-effect Headlining: • Dark fabric		○	●	○	○	○	337.50	405.00

● = Standard equipment. ○ = Optional at extra cost.

NEW INSIGNIA FEATURES/OPTIONS

	Design / Design Nav	SRI / SRI Nav	SRI / VX-Line Nav	Tech Line Nav	Elite Nav	Country Tourer	Price (£) exc. VAT	Total (£) inc. VAT
Reach and rake adjustable steering	●	●	●	●	●	●		
SEATING AND COMFORT								
Comfort front seats								
Driver's seat (eight-way adjustable):								
• Height • Reach • Backrest • Head restraint								
Front passenger's seat (six-way adjustable):	●							
• Reach • Backrest • Head restraint								
Seat trim:								
• Aida fabric seat trim inserts • Plain black fabric side bolsters								
Comfort front seats								
Driver's seat (16-way adjustable):								
• Height • Reach • Tilt • Backrest • Lumbar adjustment (four-way electrical) • Head restraint (four-way)				●	●	●		
Front passenger's seat (10-way adjustable):								
• Height • Reach • Backrest • Head restraint (four-way)								
• Heated front seats • Heated outer rear seats (Grand Sport 4X4 and all Sports Tourer models)					●			
Seat trim:								
• Oxford fabric seat trim inserts with contrast stitching • Black Morrocana side bolsters				●		●		
• Black Siena leather seat trim inserts • Black Morrocana side bolsters					●			
Ergonomic driver's sports-style seat (AGR-approved*) with sports-style front passenger seat								
Driver's seat (18-way adjustable):								
• Height • Reach • Tilt • Backrest • Seat cushion extension • Lumbar adjustment (four-way electrical)								
• Head restraint (four-way)		●	●					
Front passenger's seat (eight-way adjustable):								
• Reach • Backrest • Head restraint (four-way)								
<i>Please note: On Design models the driver's and front passenger's head restraints are only adjustable up and down</i>								
Seat trim:	○						354.17	425.00
• Aida fabric seat trim inserts • Plain black fabric side bolsters								
• Monita fabric seat trim inserts • Black Morrocana side bolsters		●	●					
Ergonomic sports-style front seats (AGR-approved*)								
Driver's and front passenger's seat (18-way adjustable):								
• Height • Reach • Tilt • Backrest • Seat cushion extension • Lumbar adjustment (four-way electrical)								
• Head restraint (four-way)								
• Heated front seats • Heated outer rear seats • FlexFold 40/20/40 split-folding rear seat back								
Seat trim:		○	○	○		○	962.50	1155.00
• Black Siena perforated leather seat trim inserts • Black Morrocana side bolsters						○	354.17	425.00
• Shale Siena perforated leather seat trim inserts • Shale Morrocana side bolsters						○	354.17	425.00

● = Standard equipment. ○ = Optional at extra cost. * = AGR (The Campaign for Healthier Backs) is an independent centre of excellence for ergonomics, based in Germany.

NEW INSIGNIA FEATURES/OPTIONS

	Design / Design Nav	SRI / SRI Nav	SRI VX-Line Nav	Tech Line Nav	Elite Nav	Country Tourer	Price (£) exc. VAT	Total (£) inc. VAT
<p>SEATING AND COMFORT</p> <p>Brownstone Nappa premium leather with ergonomic sports-style front seats (AGR-approved*) and power driver's seat (not available with Driving Assistance Pack Four)</p> <p>Driver's seat (18-way adjustable):</p> <ul style="list-style-type: none"> • Height (electrical) • Reach (electrical) • Tilt (electrical) • Backrest (electrical) • Seat cushion extension • Lumbar adjustment (four-way electrical) • Head restraint (four-way) • Massage function via three air cushions • Active ventilation backrest / seat cushion • Pneumatically adjustable backrest side bolsters <p>Front passenger's seat (18-way adjustable):</p> <ul style="list-style-type: none"> • Height • Reach • Tilt • Backrest • Seat cushion extension • Lumbar adjustment (four-way electrical) • Head restraint (four-way) • Active ventilation backrest / seat cushion <p>Seat trim:</p> <ul style="list-style-type: none"> • Brownstone Nappa premium perforated leather seat trim inserts • Brownstone Nappa premium leather side bolsters • Leather-trimmed head restraints <p>Centre armrest:</p> <ul style="list-style-type: none"> • Brownstone leather-trimmed <p>• Heated front seats • Heated outer rear seats • FlexFold 40/20/40 split-folding rear seat back</p> <p>VXR Interior Pack</p> <p>Steering wheel: • Three-spoke VX-Line design, flat bottom • Leather-covered, perforated • Electrically heated</p> <ul style="list-style-type: none"> • Satin chrome-effect bezel • Paddle shift on automatic models <p>Pedals: • Sports, alloy-effect</p> <p>Headlining: • Dark fabric</p>		○	○		○		2558.33	3070.00
<p>Rear seating</p> <ul style="list-style-type: none"> • Three person layout • Three height-adjustable and removable head restraints • ISOFIX child seat mountings incorporating top tether anchor points located on outer rear seats (does not include child seat) – <i>Allows ISOFIX child safety seats to be securely fixed into the car.</i> <i>The ISOFIX mounting system reduces forward movement in an accident and makes the child seat easier to install.</i> • Child-proof locks on rear doors <p>• 60/40 split-folding rear seat back (Grand Sport models, excluding 4X4, and Design / Design Nav Sports Tourer models)</p> <p>• FlexFold 40/20/40 split-folding rear seat back with one-touch release (Grand Sport 4X4 and all Sports Tourer / Country Tourer models)</p> <p>– <i>Also fitted to all models in conjunction with optional leather-covered ergonomic sports-style front seats.</i></p> <ul style="list-style-type: none"> • Centre rear armrest 	●	●	●	●	●	●		
	●	●	●	●	●			
		●	●	●	●	●		
		●	●	●	●	●		

● = Standard equipment. ○ = Optional at extra cost. * = AGR (The Campaign for Healthier Backs) is an independent centre of excellence for ergonomics, based in Germany.







NEW INSIGNIA FEATURES/OPTIONS

INFOTAINMENT

	Design / Design Nav	SRI / SRI Nav	SRI VX-Line Nav	Tech Line Nav	Elite Nav	Country Tourer	Price (£) exc. VAT	Total (£) inc. VAT
R4.0 IntelliLink touchscreen infotainment system <i>For use with media players, USB memory sticks, mobile phones and smartphone apps</i> Onboard features: • 7-inch colour touchscreen • DAB digital radio/AM/FM stereo radio • RDS with Traffic Programme Media connections: • USB connection with iPod control in front centre armrest • Bluetooth® A2DP audio streaming (Advanced Audio Distribution Profile) Mobile phone portal: • Bluetooth® connectivity • Handsfree calls via steering wheel controls • Vehicle microphone • Phone book access – <i>Contacts/last calls/missed calls etc. are mirrored on IntelliLink's display and are easily navigated using the touchscreen (features dependent on mobile phone).</i> Smartphone interface: • Apple CarPlay™ • Android Auto™ – <i>Smartphone projection that allows operations via voice command, touchscreen and buttons to control apps and music playback.</i>	●	●						
Navi 900 IntelliLink touchscreen navigation and infotainment system <i>For use with media players, USB memory sticks, mobile phones and smartphone apps</i> Onboard features: • 8-inch colour touchscreen • DAB digital radio/AM/FM stereo radio • RDS with Traffic Programme • 60 configurable favourites including contacts, addresses, playlists, radio stations and voice recognition Navigation features: • Satellite navigation system • 3D street level mapping • European coverage Media connections: • USB connection with iPod control in front centre armrest • Bluetooth® A2DP audio streaming (Advanced Audio Distribution Profile) Mobile phone portal: • Bluetooth® connectivity • Handsfree calls via steering wheel controls • Vehicle microphone • Phone book access – <i>Contacts/last calls/missed calls etc. are mirrored on IntelliLink's display and are easily navigated using the touchscreen (features dependent on mobile phone).</i> • SMS read out and reply Smartphone interface: • Apple CarPlay™ • Android Auto™ – <i>Smartphone projection that allows operations via voice command, touchscreen and buttons to control apps and music playback.</i> Traffic sign recognition: • Recognises different road signs, including temporary speed restrictions • Displays reminder in the driver information centre and, where fitted, the head-up display	▲	▲	●	●	●	●		
Seven speakers (five front, two rear)	●	●	●	●	●	●		
Bose® Premium Sound System (only available on Nav models, standard on 2.0 (260PS) Turbo 4X4 models. Not available in conjunction with optional emergency spare wheel) • 4x45w channels • Bose® digital amplifier with six channels of customised equalisation • 7 premium speakers • Subwoofer • Digital engine sound enhancement for 2.0 (260PS) Turbo 4X4 models		○	○	○	○	○	425.00	510.00
Steering wheel mounted audio controls for phone, music and cruise control	●	●	●	●	●	●		
Twin USB power sockets for rear seat passengers		●	●	●	●	●		
Wireless charger for mobile devices (Maximum device dimensions 75.7 x 23.6mm. Not suitable for iPhone Plus models)	○	○	○	○	○	○	133.33	160.00

● = Standard equipment. ○ = Optional at extra cost. ▲ = Standard on Nav models, see pricing page for details.

NEW INSIGNIA FEATURES/OPTIONS

ONSTAR						Design / Design Nav	SRI / SRI Nav	SRI / VX-Line Nav	Tech Line Nav	Elite Nav	Country Tourer	Price (£) exc. VAT	Total (£) inc. VAT
													
Automatic Crash Response	Wi-Fi Hotspot	Smartphone App	Stolen Vehicle Assistance	Vehicle Diagnostics	Destination Download	●	●	●	●	●	●		
<p>Vauxhall OnStar – your personal on board assistant*</p> <p><i>Many car brands talk about innovation as soon as they improve their cup holders but this innovative system, now available on selected models**, is revolutionary: 24/7, 365 days a year, Vauxhall OnStar puts you in touch with a trained advisor, not a machine. With OnStar you have access to a host of innovations, from Vehicle Diagnostics and Smartphone Function to a fully integrated 4G Wi-Fi Hotspot†. In the event of an accident, Vauxhall OnStar even automatically calls for help, for an incomparable feeling of safety.</i></p> <p>* = Includes 12 months of OnStar services from date of first registration and a 3 month/3 GB Wi-Fi free trial period (whichever comes first) effective from the date the customer accepts the nominated network operator Wi-Fi Ts&Cs. Destination download feature only operates on models fitted with Navi 900 IntelliLink satellite navigation system.</p> <p>** = The OnStar Services require activation and are subject to mobile network coverage and availability. Wi-Fi Hotspot service requires account with nominated network operator.</p> <p>† = 4G is subject to mobile network coverage and availability. Charges apply after the free trial period. The OnStar subscription packages could be different from the services included in the free trial package. Check www.vauxhall.co.uk/onstar for terms and conditions, details of availability, coverage and charges.</p>													

● = Standard equipment.

NEW INSIGNIA FEATURES/OPTIONS

	Design / Design Nav	SRI / SRI Nav	SRI / VX-Line Nav	Tech Line Nav	Elite Nav	Country Tourer	Price (£) exc. VAT	Total (£) inc. VAT
HEATING AND VENTILATION								
Air conditioning <ul style="list-style-type: none"> • Air recirculation facility • Cabin particulate filter – Removes dust, airborne particles and pollen. • Multi-speed fan • Illuminated controls • Rear floor heating ducts 	●							
Electronic climate control including air conditioning <ul style="list-style-type: none"> • Dual-zone control – Allowing different temperature settings for driver and front passenger • Automatic front seat heating – On models ordered with Winter Pack or leather trim, front seat heating is switched on automatically to help achieve the requested interior temperature. • Advanced predictive logic control system using sun and humidity sensors • Partial air recirculation – Faster warm up/cool down. • Cabin particulate filter – Removes dust, airborne particles and pollen. • Automatic air direction and fan speed with manual override • LCD temperature display • Illuminated controls • Rear floor heating ducts <div style="display: flex; justify-content: space-between;"> <div style="background-color: #e0e0e0; padding: 2px;">✔ Set and forget temperature control</div> <div style="background-color: #e0e0e0; padding: 2px;">✔ Set different temperature for driver and front passenger</div> </div>	○	●	●	●	●	●	337.50	405.00
Additional features <ul style="list-style-type: none"> • Four adjustable facia vents • Windscreen demist vents • Side window demist vents • Heated rear screen with timed cut-off 	●	●	●	●	●	●		
Winter Pack One – models with cloth trim, without VXR Interior Pack <ul style="list-style-type: none"> • Heated leather-covered steering wheel • Heated front seats – Three temperature settings. • Heated windscreen <div style="background-color: #e0e0e0; padding: 2px;">✔ Warm welcome</div>	○	○		○		○	550.00	660.00
Winter Pack Two – models with leather trim, without VXR Interior Pack <ul style="list-style-type: none"> • Heated leather-covered steering wheel • Heated windscreen <div style="background-color: #e0e0e0; padding: 2px;">✔ Warm welcome</div>		○		○		○	333.33	400.00
Winter Pack Three – models with leather trim and VXR Interior Pack <ul style="list-style-type: none"> • Heated windscreen 		○	○	○		○	125.00	150.00
Winter Pack Four – models with cloth trim and VXR Interior Pack <ul style="list-style-type: none"> • Heated front seats – Three temperature settings. • Heated windscreen <div style="background-color: #e0e0e0; padding: 2px;">✔ Warm welcome</div>		○	○	○		○	341.67	410.00

● = Standard equipment. ○ = Optional at extra cost.

NEW INSIGNIA FEATURES/OPTIONS

	Design / Design Nav	SRI / SRI Nav	SRI VX-Line Nav	Tech Line Nav	Elite Nav	Country Tourer	Price (£) exc. VAT	Total (£) inc. VAT
INTERIOR CONVENIENCE / LIGHTING								
Convenience features <ul style="list-style-type: none"> • Front 12-volt electrical accessory socket • Driver's and front passengers sunvisors • Driver's and front passenger's vanity mirrors • Dipping rear-view mirror 	●	●	●	●	●	●		
Automatically dimming anti-dazzle rear-view mirror – <i>On Design models, fitted in conjunction with Sight and Light Pack. Not available separately.</i>	◻	●	●	●	●	●		
Front centre adjustable armrest with 4-litre storage capacity (2.8 litres if optional wireless charger is ordered)	●	●	●	●	●	●		
Standard ambient lighting <ul style="list-style-type: none"> • Central front courtesy light • Central rear courtesy light • Fade up/fade down • Twin front reading lights with illuminated switches • Twin rear reading lights • Ambient LED facia/centre console downlighter 	●	●	●	●	●	●		
Premium ambient lighting <ul style="list-style-type: none"> • Driver's and front passenger's LED illuminated vanity mirrors with flip-up covers • Ambient LED lighting in front doors and below audio unit 		●	●	●	●	●		
Interior storage <ul style="list-style-type: none"> • Illuminated glovebox with lid • Front door pockets with 1.5-litre bottle holder • Two drinks holders in centre console • Rear door pockets with 1-litre bottle holder • Storage pockets on front seat backs – <i>On Design models, fitted in conjunction with sports front seats. Not available separately.</i> 	●	●	●	●	●	●		
Luggage area <ul style="list-style-type: none"> • Luggage compartment cover (Grand Sport models) • Luggage compartment retractable cover (Sports Tourer / Country Tourer models) • Illuminated load area • Fully carpeted load area • Interior tailgate handle • Four load restraint lashing eyes • Twin gas-assisted tailgate struts • Storage tray in spare wheel well 	●	●	●	●	●	●		
Luggage compartment 12-volt electrical accessory socket (Sports Tourer / Country Tourer models)		●	●	●	●	●		
FlexOrganiser® Pack (Sports Tourer / Country Tourer models) <ul style="list-style-type: none"> • Four side rails • 3D storage net • Side net pocket • Four side rail hooks 	○	○	○	○	○	○	100.00	120.00

● = Standard equipment. ○ = Optional at extra cost. ◻ = Available as part of an extra-cost option pack.

NEW INSIGNIA FEATURES/OPTIONS

	Design / Design Nav	SRI / SRI Nav	SRI VX-Line Nav	Tech Line Nav	Elite Nav	Country Tourer	Price (£) exc. VAT	Total (£) inc. VAT
EXTERIOR CONVENIENCE								
Windscreen wipers	●	●	●	●	●	●		
• Two-speed windscreen wipers with variable intermittent wipe • Intermittent rear window wash/wipe								
• Rain-sensitive windscreen wipers – <i>On Design models, fitted in conjunction with Sight and Light Pack. Not available separately.</i>	□	●	●	●	●	●		
Door mirrors	●	●	●	●	●	●		
• Twin electrically adjustable/heated door mirrors • Manually folding door mirrors								
• Electrically foldable door mirrors with puddle lights – <i>Fitted as part of Driving Assistance Pack Four. Not available separately.</i>	□	□	□	□	□	□		
Windows	●	●	●	●	●	●		
• Electrically operated front and rear windows with safety autoreverse and one-touch up/down facility • Heated rear window								
• Solar heat-absorbing windscreen • Tinted windows	●	●	●	●	●	●		
• Dark-tinted rear windows		●	●	○	●	●	237.50	285.00
• Noise-reducing laminated side windows	○	○	○	○	○	○	183.33	220.00
Glass sunroof (Grand Sport models)		○	○	○	○		587.50	705.00
• Electrically operated tilt and slide glass sunroof section, located above front seats • Electrically operated sunblind								
Panoramic glass sunroof (Sports Tourer / Country Tourer models)		○	○	○	○	○	800.00	960.00
• Electrically operated tilt and slide glass sunroof section, located above front seats								
• Additional fixed panoramic glass rear sunroof • Electrically operated sunblinds								
Power tailgate (Sports Tourer / Country Tourer models)		○	○	○	○	○	316.67	380.00
• Under-bumper release sensor • Tailgate close switch								
• Maximum opening height can be set to avoid damage in areas with low ceiling heights								
Roof rails (Sports Tourer / Country Tourer models)	●							
• Black		●	●	●	●	●		
• Silver-effect								
Towing Pack	○	○	○	○	○	○	570.83	685.00
• Retractable tow bar • Trailer stability programme integrated into ESP system								

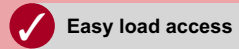

Easy load access









● = Standard equipment. ○ = Optional at extra cost. □ = Available as part of an extra-cost option pack.

NEW INSIGNIA FEATURES/OPTIONS

EXTERIOR STYLING	<i>Design / Design Nav</i>	<i>SRI / SRI Nav</i>	<i>SRI VXR-Line Nav</i>	<i>Tech Line Nav</i>	<i>Elite Nav</i>	<i>Country Tourer</i>	Price (£) exc. VAT	Total (£) inc. VAT
Body styling								
• Chrome-effect front grille bar • Body-colour door handles • Body-colour door mirrors	●	●	●	●	●	●		
• Chrome-effect upper window trim (excluding Design Grand Sport models)								
• Body-colour door handles with chrome-effect insert				●	●	●		
• Rear spoiler (Grand Sport models)		●	●					
• Matt black B-pillars	●							
• Gloss black B-pillars		●	●	●	●	●		
• Matt black lower window trim	●	●	●					
• Gloss black lower window trim				●	●	●		
• Anthracite wheel arch and side sill extensions						●		
• Front and rear bumpers incorporating silver-effect skid plates						●		
VXR Styling Pack (not available on 1.6 Turbo D (110PS) ecoTEC models)								
• Sports-style front and rear bumpers • Side sills • Rear spoiler (Grand Sport models)		○	●	○	○		708.33	850.00
• Visible exhaust tailpipe (excluding Grand Sport 1.5 (165PS) Turbo models)								
Design Plus Pack (not available on 1.6 diesel ecoTEC models)								
• 18-inch bi-colour alloy wheels • 245/45 R 18 tyres • Front fog lights	○						500.00	600.00
Tech Line Nav Plus Pack (not available on 1.6 diesel ecoTEC models)								
• 18-inch bi-colour alloy wheels • 245/45 R 18 tyres • Front fog lights				○			416.67	500.00

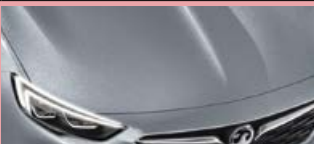
● = Standard equipment. ○ = Optional at extra cost.





NEW INSIGNIA FEATURES/OPTIONS

EXTERIOR COLOURS		Design / Design Nav	SRI / SRI Nav	SRI / VX-Line Nav	Tech Line Nav	Elite Nav	Country Tourer	Price (£) exc. VAT	Total (£) inc. VAT
	Royal Blue • Solid paint	●	●	●	●	●	●		
	Summit White • Brilliant paint	○	○	○	○	○	○	237.50	285.00
	Lava Red • Brilliant paint								
	Satin Steel Grey • Two-coat metallic paint								
	Flip Chip Silver • Two-coat metallic paint								
	Mineral Black • Two-coat metallic paint	○	○	○	○	○	○	470.83	565.00
	Sovereign Silver • Two-coat metallic paint								
	Cosmic Grey • Two-coat pearlescent paint								

● = Standard equipment. ○ = Optional at extra cost.

The colours reproduced may vary slightly from the actual paint colour. As a result they should be used as a guide only. Your Vauxhall Retailer has a comprehensive display of our paint samples.



NEW INSIGNIA FEATURES/OPTIONS

EXTERIOR COLOURS		Design / Design Nav	SRI / SRI Nav	SRI / VX-Line Nav	Tech Line Nav	Elite Nav	Country Tourer	Price (£) exc. VAT	Total (£) inc. VAT
	Emerald Green • Two-coat premium paint		Dark Caramel • Two-coat premium paint						
	Darkmoon Blue • Two-coat premium paint		Rioja Red • Two-coat premium paint	○	○	○	○	○	○
	Abalone White • Tri-coat premium paint			○	○	○	○	○	○

● = Standard equipment. ○ = Optional at extra cost.

The colours reproduced may vary slightly from the actual paint colour. As a result they should be used as a guide only. Your Vauxhall Retailer has a comprehensive display of our paint samples.



NEW INSIGNIA FEATURES/OPTIONS

WHEELS AND TYRES		<i>Design / Design Nav</i>	<i>SRI / SRI Nav</i>	<i>SRI VX-Line Nav</i>	<i>Tech Line Nav</i>	<i>Elite Nav</i>	<i>Country Tourer</i>	Price (£) exc. VAT	Total (£) inc. VAT
17-inch steel emergency spare wheel (in lieu of emergency tyre inflation kit) – <i>Not available on 2.0 (260PS) Turbo 4X4 models, or with Bose® premium sound system.</i>		○	○	○	○	○	○	91.67	110.00
	17-inch bi-colour structure wheels <ul style="list-style-type: none"> • 215/55 R 17 ultra-low rolling resistance tyres (1.6 diesel ecoTEC engines) • Emergency tyre inflation kit (in lieu of spare wheel) 	●							
	17-inch five twin-spoke alloy wheels <ul style="list-style-type: none"> • 215/55 R 17 ultra-low rolling resistance tyres (1.6 diesel ecoTEC engines) • 225/55 R 17 tyres (excluding 1.6 diesel ecoTEC engines) • Emergency tyre inflation kit (in lieu of spare wheel) 		●		●				
	• All models excluding 1.6 diesel ecoTEC	●							
	• 1.6 diesel ecoTEC models only. Not available with other models			●		●			
	18-inch five-spoke alloy wheels <ul style="list-style-type: none"> • 245/45 R 18 tyres • Emergency tyre inflation kit (in lieu of spare wheel) • Not available on 1.6 (136PS) diesel ecoTEC models 			●					

● = Standard equipment. ○ = Optional at extra cost.

NEW INSIGNIA FEATURES/OPTIONS

WHEELS AND TYRES

	Design / Design Nav	SRI / SRI Nav	SRI VX-Line Nav	Tech Line Nav	Elite Nav	Country Tourer	Price (£) exc. VAT	Total (£) inc. VAT
 <p>18-inch bi-colour alloy wheels</p> <ul style="list-style-type: none"> • 245/45 R 18 tyres • Emergency tyre inflation kit (in lieu of spare wheel) • Not available on 1.6 diesel ecoTEC or 2.0 (260PS) Turbo 4X4 models • Available as part of Plus Pack on Design and Tech Line Nav models 	○						420.83	505.00
		○		○	●		337.50	405.00
 <p>18-inch bi-colour five twin-spoke alloy wheels</p> <ul style="list-style-type: none"> • 235/50 R 18 tyres • Emergency tyre inflation kit (in lieu of spare wheel) 						●		
 <p>20-inch five twin-spoke alloy wheels</p> <ul style="list-style-type: none"> • 245/35 R 20 tyres • Emergency tyre inflation kit (in lieu of spare wheel) • Only available as an option on 2.0 (170PS) Turbo D models • Standard on 2.0 (260PS) Turbo 4X4 models 		○		○			733.33	880.00
			○		○		395.83	475.00
						●		

● = Standard equipment. ○ = Optional at extra cost.

NEW INSIGNIA SPECIFICATIONS

PETROL ENGINES

	1.5 (140PS) Turbo ecoTEC with Start/Stop	1.5 (165PS) Turbo with Start/Stop	2.0 (260PS) Turbo with Start/Stop
Capacity	1490cc	1490cc	1998cc
Maximum power	140PS (103kW) @ 5600rpm	165PS (121kW) @ 5600rpm	260PS (191kW) @ 5500rpm
Maximum torque	250Nm (184 lb.ft.) @ 2000-4100rpm	250Nm (184 lb.ft.) @ 2000-4500rpm	400Nm (295 lb.ft.) @ 3000-4000rpm
Configuration	4 cylinders, 4 valves per cylinder, double overhead camshafts	4 cylinders, 4 valves per cylinder, double overhead camshafts	4 cylinders, 4 valves per cylinder, double overhead camshafts
Fuel/induction system	Turbocharger with intercooler. Variable Valve Timing (VVT). Direct fuel injection	Turbocharger with intercooler. Variable Valve Timing (VVT), Direct fuel injection	Twin-scroll turbocharger with intercooler. Variable Valve Timing (VVT). Direct fuel injection
Emission compliance	Euro 6	Euro 6	Euro 6
Service interval	20,000 miles or 1 year (whichever occurs sooner)	20,000 miles or 1 year (whichever occurs sooner)	20,000 miles or 1 year (whichever occurs sooner)

DIESEL ENGINES

	1.6 (110PS) Turbo D ecoTEC with Start/Stop	1.6 (136PS) Turbo D including ecoTEC with Start/Stop	2.0 (170PS) Turbo D with Start/Stop
Capacity	1598cc	1598cc	1956cc
Maximum power	110PS (81kW) @ 3500rpm	136PS (100kW) @ 3500-4000rpm	170PS (125kW) @ 3750rpm
Maximum torque	300Nm (221 lb.ft.) @ 1750-2000rpm	320Nm (236 lb.ft.) @ 2000-2250rpm	400Nm (295 lb.ft.) @ 1750-2500rpm
Configuration	4 cylinders, 4 valves per cylinder, double overhead camshafts	4 cylinders, 4 valves per cylinder, double overhead camshafts	4 cylinders, 4 valves per cylinder, double overhead camshafts
Fuel/induction system	Turbocharger with intercooler. Common rail fuel injection	Variable geometry turbocharger with intercooler. Common rail fuel injection	Variable geometry turbocharger with intercooler. Common rail fuel injection
Emission compliance	Euro 6 with Diesel Particulate Filter	Euro 6 with Diesel Particulate Filter	Euro 6 with Diesel Particulate Filter
Service interval	20,000 miles or 1 year (whichever occurs sooner)	20,000 miles or 1 year (whichever occurs sooner)	20,000 miles or 1 year (whichever occurs sooner)

NEW INSIGNIA SPECIFICATIONS

GRAND SPORT PERFORMANCE, FUEL ECONOMY AND EMISSIONS

	Wheel size (inches)	Performance (manufacturer's figures)		Fuel economy mpg (litres/100km) [#]			CO ₂ emissions g/km [#]	Vehicle Excise Duty*		Benefit in kind company car taxation rates – 2017/18 tax year
		Maximum speed (mph)	Acceleration 0-60mph (sec)	Urban driving	Extra-urban driving	Combined figure		First year rate	Standard rate	
Manual										
1.5 (140PS) Turbo ecoTEC	17/18	130	9.3	37.7 (7.5)	57.6 (4.9)	47.6 (5.9)	133	£200	£140	25%
1.5 (165PS) Turbo	17/18	138	8.4	38.7 (7.3)	54.3 (5.2)	47.1 (6.0)	136	£200	£140	26%
1.6 (110PS) Turbo D ecoTEC (with ULRR tyres)	17	127	10.9	61.4 (4.6)	78.5 (3.6)	70.6 (4.0)	105	£140	£140	23%
1.6 (136PS) Turbo D ecoTEC (with ULRR tyres)	17	131	9.9	55.4 (5.1)	72.4 (3.9)	65.7 (4.3)	114	£160	£140	24%
2.0 (170PS) Turbo D	17/18/20	140	8.2	42.2 (6.7)	65.7 (4.3)	54.3 (5.2)	136	£200	£140	29%
Automatic										
2.0 (260PS) Turbo 4X4	20	155	6.9	25.2 (11.2)	39.8 (7.1)	32.8 (8.6)	197	£1200	£140	37%
1.6 (136PS) Turbo D	17/18	126	10.2	46.3 (6.1)	62.8 (4.5)	55.4 (5.1)	134	£200	£140	28%
2.0 (170PS) Turbo D	17/18/20	139	8.4	38.2 (7.4)	62.8 (4.5)	51.4 (5.5)	145	£200	£140	31%

SPORTS TOURER PERFORMANCE, FUEL ECONOMY AND EMISSIONS

	Wheel size (inches)	Performance (manufacturer's figures)		Fuel economy mpg (litres/100km) [#]			CO ₂ emissions g/km [#]	Vehicle Excise Duty*		Benefit in kind company car taxation rates – 2017/18 tax year
		Maximum speed (mph)	Acceleration 0-60mph (sec)	Urban driving	Extra-urban driving	Combined figure		First year rate	Standard rate	
Manual										
1.5 (140PS) Turbo ecoTEC	17/18	129	9.6	36.7 (7.7)	57.6 (4.9)	47.1 (6.0)	136	£200	£140	26%
1.5 (165PS) Turbo	17/18	135	8.6	37.2 (7.6)	54.3 (5.2)	46.3 (6.1)	139	£200	£140	26%
1.6 (110PS) Turbo D ecoTEC (with ULRR tyres)	17	125	11.1	56.5 (5.0)	74.3 (3.8)	65.7 (4.3)	112	£160	£140	24%
1.6 (136PS) Turbo D ecoTEC (with ULRR tyres)	17	132	10.1	53.3 (5.3)	70.6 (4.0)	62.8 (4.5)	119	£160	£140	25%
2.0 (170PS) Turbo D	17/18/20	139	8.4	40.9 (6.9)	65.7 (4.3)	53.3 (5.3)	139	£200	£140	29%
Automatic										
2.0 (260PS) Turbo 4X4	20	152	7.1	24.6 (11.5)	39.8 (7.1)	32.5 (8.7)	199	£1200	£140	37%
1.6 (136PS) Turbo D ecoTEC (with ULRR tyres)	17	127	10.5	45.6 (6.2)	61.4 (4.6)	54.3 (5.2)	137	£200	£140	29%
2.0 (170PS) Turbo D	17/18/20	137	8.6	37.7 (7.5)	61.4 (4.6)	49.6 (5.7)	150	£200	£140	32%

ULRR = Ultra-low rolling resistance. * = Correct at time of publication.

= Fuel consumption information is official government environmental data, tested in accordance with the relevant EU directive. Official EU-regulated test data is provided for comparison purposes and actual performance will depend on driving style, road conditions and other non-technical factors.

NEW INSIGNIA SPECIFICATIONS

COUNTRY TOURER PERFORMANCE, FUEL ECONOMY AND EMISSIONS**

	Wheel size (inches)	Performance (manufacturer's figures)		Urban driving	Fuel economy mpg (litres/100km) [#]		CO ₂ emissions g/km [#]	Vehicle Excise Duty*		Benefit in kind company car taxation rates – 2017/18 tax year
		Maximum speed (mph)	Acceleration 0-60mph (sec)		Extra-urban driving	Combined figure		First year rate	Standard rate	
Manual										
2.0 (170PS) Turbo D	18	137	8.6	39.8 (7.1)	61.4 (4.6)	51.4 (5.5)	145	£200	£140	31%
2.0 (170PS) Turbo D 4X4	18	135	9.3	33.6 (8.4)	52.3 (5.4)	43.5 (6.5)	172	£800	£140	36%
Automatic										
2.0 (170PS) Turbo D	18	135	8.8	37.2 (7.6)	56.5 (5.0)	47.1 (6.0)	157	£500	£140	33%

* = Correct at time of publication. ** = Provisional data.

= Fuel consumption information is official government environmental data, tested in accordance with the relevant EU directive. Official EU-regulated test data is provided for comparison purposes and actual performance will depend on driving style, road conditions and other non-technical factors.

TRANSMISSION

Six-speed manual gearbox

Petrol engines: 1.5 (140PS) Turbo ecoTEC and 1.5 (165PS) Turbo models

Diesel engines: 1.6 (110/136PS) Turbo D ecoTEC and 2.0 (170PS) Turbo D models

Automatic transmission with ActiveSelect®

Six-speed automatic transmission: Optional at extra cost on 1.6 (136PS) Turbo D models.

Eight-speed automatic transmission: Standard on 2.0 (260PS) Turbo 4X4, optional at extra cost on 2.0 (170PS) Turbo D front-wheel drive models.

The latest generation automatic transmissions available on New Insignia, incorporating Start/Stop technology, offer improved fuel economy and refinement over previous versions. On the road, a wide selection of shift patterns is adapted to the style and habits of the driver, anticipating when maximum acceleration or maximum efficiency is required. The electronic control will also adapt to the prevailing road conditions, reducing gear shifting when climbing or descending and using engine braking assistance during down changes.

The ActiveSelect® manual mode allows the gear lever to be used like a sequential manual gearbox – you simply push the lever forward or back to change up or down the gears. The eight-speed transmission includes a range of driver-selectable modes.

Four-wheel drive system

Standard on Elite Nav 2.0 (260PS) Turbo 4X4 and Country Tourer 4X4 models. The sophisticated four-wheel drive system replaces the conventional rear axle differential with two electronically controlled clutches which allows New Insignia to take advantage of the latest torque vectoring technology. This ensures that torque is directed to the wheels with the greatest grip, thus improving handling in all conditions and traction in slippery conditions.

FUEL TANK CAPACITY

62 litres (13.6 gallons)

ADBLUE TANK CAPACITY

15 litres (3.3 gallons)

NEW INSIGNIA SPECIFICATIONS

WEIGHTS AND TOWING DATA kg

	Gross vehicle weight			Maximum towing weights Trailer with brakes (without brakes)		
	Grand Sport	Sports Tourer	Country Tourer	Grand Sport	Sports Tourer	Country Tourer
1.5 (140PS) Turbo ecoTEC	2015	2080	–	1405 (700)	1405 (730)	–
1.5 (165PS) Turbo	2015	2085	–	1405 (700)	1405 (730)	–
2.0 (260PS) Turbo 4X4 automatic	2245	2295	–	2200 (750)	2200 (750)	–
1.6 (110PS) Turbo D ecoTEC	2035	2125	–	1405 (720)	1405 (750)	–
1.6 (136PS) Turbo D ecoTEC	2070	2140	–	1405 (730)	1405 (750)	–
1.6 (136PS) Turbo D automatic (inc. Sports Tourer ecoTEC)	2095	2165	–	1300 (730)	1300 (750)	–
2.0 (170PS) Turbo D	2185	2240	2240	1950 (750)	1950 (750)	1950 (750)
2.0 (170PS) Turbo D automatic	2220	2270	2270	1700 (750)	1700 (750)	1700 (750)
2.0 (170PS) Turbo D 4X4	–	–	2330	–	–	2200 (750)

Gross vehicle weight is the total permissible weight of the vehicle including passengers and their luggage. The maximum roof rack loading should not exceed 100kg on all models. The maximum towing weights are based on the ability of the car, with two occupants of 75kg each, to restart on a 12% gradient, which is approximately 1 in 8.3, at sea level. The permitted trailer load applies up to the specified incline and up to an altitude of 1000 metres above sea level. The permissible gross train weight decreases by 10% for every 1000 metres of additional altitude. Any extra weight, such as luggage or additional passengers, should be deducted from the maximum towing weight. With a trailer fully loaded, maximum noseweight should not exceed 60kg (75kg on Sports Tourer models, 90kg on 2.0 (260PS) Turbo 4X4 and 2.0 (170PS) Turbo D models). Always fit Vauxhall towing attachments and accessories available from your Vauxhall Retailer. They are designed specifically for Vauxhall models and carry a 12-month guarantee. During trailer towing do not exceed a maximum speed of 60mph. This speed limit is also applicable in countries with higher permitted speeds for trailer-vehicle combinations. Pay attention to the local speed limits. For trailers with low driving stability and caravans the use of an oscillation damper is strongly recommended.

SUSPENSION

Front: Independent. Lightweight MacPherson struts with gas-pressure dampers and coil springs. Anti-roll bar.

Rear: Lightweight multi-link (FWD - 4-link; 4X4 – 5-link) with rising-rate mini-block coil springs and gas-pressure dampers. Anti-roll bar.

FlexRide (Adaptive Stability Technology) system

FlexRide offers drivers the choice of three distinct driving modes – Normal (default setting), Sport or Tour.

- Sport mode: This stiffens the car's suspension and sharpens steering and throttle responses. It also raises the threshold at which the ESP and traction control systems are activated, enhancing dynamic performance
- Tour mode: Ideal for long motorway journeys, the Tour mode adjusts the dampers to a softer setting to create a perceptibly smoother ride and further enhance Insignia's ride comfort
- Continuous damping control: Utilises data from up to 11 variables including acceleration, braking and cornering to constantly control the suspension for optimum stability, driver engagement and comfort. Operates in all three driving modes
- Gas-filled rear dampers: Insignia's rear dampers are increased to 37mm diameter for enhanced performance

BODY

Aerodynamic drag co-efficient:
Cd 0.26

STEERING

- Speed-sensitive electric power-assisted steering
- Turning circle (kerb-to kerb):
– 11.15m (36.6ft.)

BRAKING AND STABILITY

- Electronic Stability Programme (ESP)
- Cornering brake control
- Straight line stability control
- Rollover mitigation
- Drag torque control
- Hill start assist
- Anti-lock Braking System (ABS)
- Emergency brake assist
- Fading brake support
- Electronic brakeforce distribution
- Adaptive brake lights

1.5 (140PS/165PS) Turbo

Front ventilated discs: 300mm diameter

Rear discs: 288mm diameter

1.6 (110PS) Turbo D

Front ventilated discs: 300mm diameter

Rear discs: 288mm diameter

1.6 (136PS) Turbo D

Front ventilated discs: 321mm diameter

Rear discs: 288mm diameter

2.0 (260PS) Turbo 4X4

Front ventilated discs: 345mm diameter

Rear ventilated discs: 315mm diameter

2.0 (170PS) Turbo D

Front ventilated discs: 321mm diameter

Rear ventilated discs: 315mm diameter

2.0 (170PS) Turbo D 4X4

Front ventilated discs: tbamm diameter

Rear ventilated discs: tbamm diameter

NEW INSIGNIA SPECIFICATIONS

EXTERIOR DIMENSIONS millimetres (inches)

Grand Sport

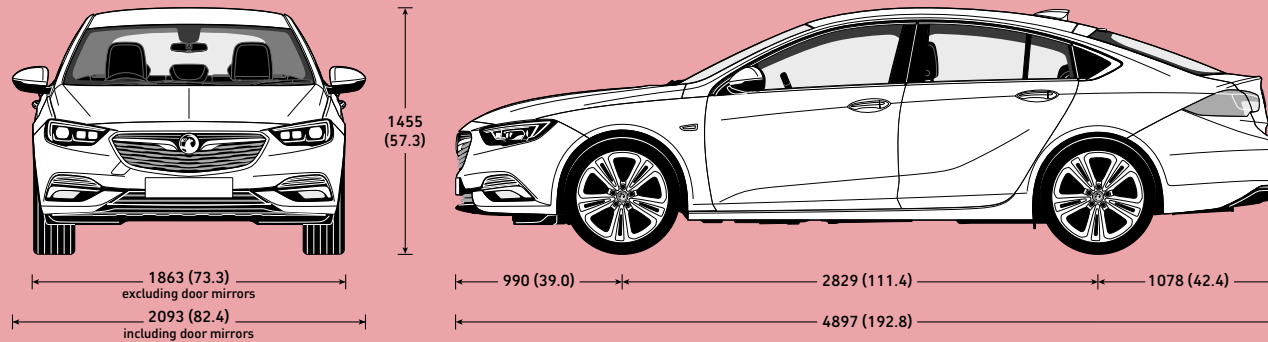

Sports Tourer

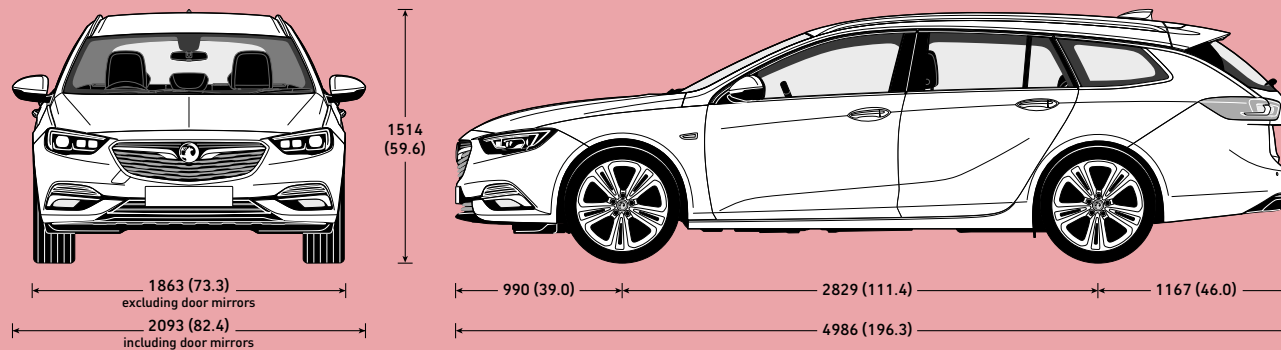

Country Tourer

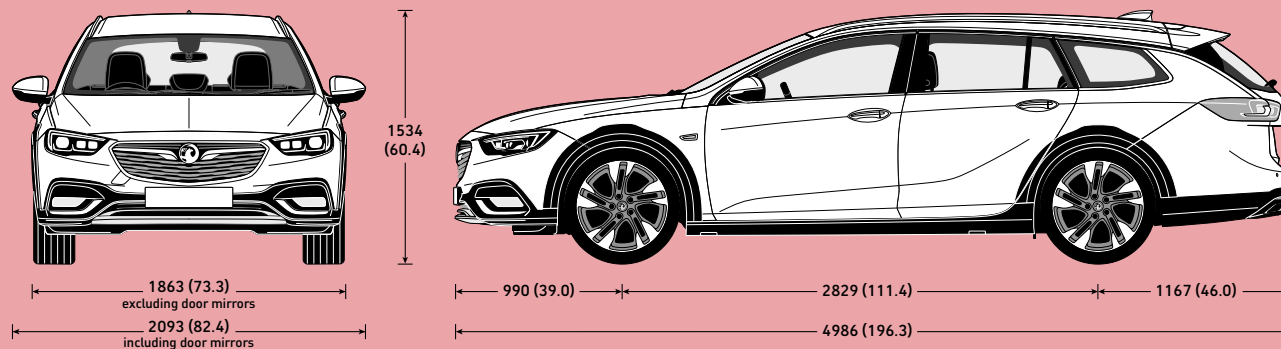

LOADSPACE DIMENSIONS mm (inches)

	Grand Sport	Sports Tourer
Load floor length (rear seats folded)	1940 (76.4)	2005 (78.9)
Load floor length (behind rear seats)	1133 (44.6)	1178 (46.3)
Load area width	1030 (40.5)	1030 (40.5)
Load area height	722 (28.4)	794 (31.2)
Tailgate aperture height	557 (21.9)	711 (28.0)

LOADSPACE CAPACITIES* litres (cu.ft.)

	Grand Sport	Sports Tourer
Rear seat up (under luggage compartment cover)	490 (17.3)	560 (19.8)
Rear seat down (measured to roof)	1450 (51.1)	1665 (58.8)

* = Measured using the ECIE method. When an optional spare wheel is specified loadspace capacity is reduced due to a raised luggage compartment floor.

NEW INSIGNIA OFFERS IN DETAIL – TERMS AND CONDITIONS

Unless otherwise stated, all offers described are available on orders or registrations between 19 December 2017 – 18 December 2017. Offer prices quoted are correct at the time of publication (October 2017). Prices are subject to change. In line with Vauxhall's policy of price transparency, the offer price shown is an on-the-road price including VAT on cars (excluding VAT on Commercial Vehicles), number plates and delivery to Retailer of £700.00 (£583.33 excluding VAT), 12 months' Government Vehicle Excise Duty (variable depending upon model – refer to the individual model price guides online) and the DVLA's new vehicle first registration fee of £55.00. Excludes fuel and insurance. Offers may not apply to Retailer stocks and are subject to availability. Restrictions may apply. Contact your Retailer for details. General Motors UK Limited trading as Vauxhall Motors reserves the right to change, amend or withdraw these offers at any point in time.

FLEXIBLE FINANCE

Available on selected models only, at participating Retailers. Conditional sale. Finance subject to status. Terms and Conditions apply. Applicants must be 18+. Finance supplied by Vauxhall Finance, CF15 7YT. Vauxhall Deposit Contributions vary and exclude certain models and are only available when vehicle is financed through Vauxhall Finance. 24-48 month term. Offer will apply to private individuals, Vauxhall Partners and small businesses 1- 24 units (purchase only, excluding B2B supported units). All other customers are excluded. Refer to www.vauxhall.co.uk/offers or contact your local Vauxhall Retailer for details.

FLEXIBLE PCP

Offer subject to availability at participating Retailers only. Personal Contract Purchase. Finance subject to status. Terms and Conditions apply. Applicants must be 18+. Finance by Vauxhall Finance, CF15 7YT. 24-48 month term available. Vauxhall deposit contribution only available when vehicle financed through Vauxhall Finance. At the end of the agreement there are three options: i) Pay the optional final payment to own the vehicle, ii) Return the vehicle, or iii) Replace: Part Exchange the vehicle, where equity is available. UK-supplied vehicles only. Offer applies to private individuals, Vauxhall Partners and small businesses 1-24 units (purchase only excluding B2B supported units). All other customers are excluded.

PERSONAL CONTRACT HIRE

Personal contract hire offer on vehicles ordered by 18 December 2017, subject to availability and status. Age 18+ only. Figures based on a non-maintenance contract hire package. Excess miles over contracted mileage of 24,000 over 36 months charged at a maximum of 14 pence per mile. Excess charges also apply if you breach manufacturer servicing or maintenance guidelines or if the car exceeds BVRLA Fair Wear & Tear guidelines for its age/mileage when it is returned to Vauxhall Leasing. Package includes Road Fund Licence and Vauxhall Assistance. Guarantee/indemnity may be required. Prices and details are subject to change without notice. For full specification and Ts&Cs contact your local Retailer. **You will not own the car.** ALD Automotive Ltd., trading as Vauxhall Leasing, BS16 7LB. Authorised and regulated by the Financial Conduct Authority.

Please note not all offers apply to all models.

NEW INSIGNIA ADDITIONAL INFORMATION

ON-THE-ROAD PRICES

To eliminate uncertainty about hidden costs when buying a new car, Vauxhall publishes on-the-road recommended retail prices (RRP) and these are shown in the pricing tables within this price guide. These prices include VAT, number plates and delivery to Retailer of £700.00 (including £116.67 VAT), 12 months' Government Vehicle Excise Duty (see opposite for details) and the DVLA new vehicle first registration fee of £55.00*.

Please note: The on-the-road recommended retail price (RRP) does not include fuel supplied by the Retailer, motor insurance or any other goods or services supplied by agreement between the Retailer and the customer.

PRICE PROTECTION

Order a new Vauxhall for build in the current model year (as confirmed by your Retailer) for delivery no more than three months in advance and the price you are quoted is the price you pay. This is irrespective of any subsequent price rises between placing your order and delivery of your new car, but you must take delivery as soon as the car is available. Vauxhall Motors Limited is not liable for price adjustments caused by Government changes in the rate of VAT (currently 20%), Vehicle Excise Duty, DVLA new vehicle first registration fee or by any other applicable legislation or regulations.

VEHICLE EXCISE DUTY

The amount of Vehicle Excise Duty (road fund licence) payable on new cars varies depending on the level of carbon dioxide (CO₂) emissions produced by the vehicle. CO₂ emissions are measured in grammes (g) per kilometre (km) travelled and divided into 13 charging bands shown in the table below.

A 'first year rate' of Vehicle Excise Duty is payable on all new cars and in subsequent years the amount payable reverts to the 'standard rate'. From 1 April 2017 the breakpoints for each of these bands have been revised. Also, for vehicles with a list price over £40,000, including factory-fitted options, an additional £310 is payable for the first five years of standard rate payments.

Vehicle Excise Duty*

	CO ₂ emissions (g/km)	First year rate	Standard rate
Band A	0	£0.00	£0.00
Band B	1-50	£10.00	£140.00
Band C	51-75	£25.00	£140.00
Band D	76-90	£100.00	£140.00
Band E	91-100	£120.00	£140.00
Band F	101-110	£140.00	£140.00
Band G	111-130	£160.00	£140.00
Band H	131-150	£200.00	£140.00
Band I	151-170	£500.00	£140.00
Band J	171-190	£800.00	£140.00
Band K	191-225	£1200.00	£140.00
Band L	226-255	£1700.00	£140.00
Band M	over 255	£2000.00	£140.00

* = Correct at time of issue.

VAUXHALL LEASING

As Vauxhall's own contract hire and fleet management operation, Vauxhall Leasing provides a one-stop-shop for competitive car and van leasing solutions – for business users and private individuals. Working with the Vauxhall Retailer network, we combine the support of a national contract with the convenience of a local contact.

For further information, please see your local Vauxhall Retailer or call us on **0117 908 6433**. Alternatively, you can visit our website at www.vauxhall-leasing.co.uk

IN THE EVENT OF AN ACCIDENT...

Vauxhall Accident Management helps keep you mobile following an accident. Benefits include vehicle recovery, Vauxhall-approved repairs and contacting your insurer. For more details, visit vauxhall.co.uk/AccidentManagement

TRUST VAUXHALL

CUSTOMER CARE COMMITMENT

For added peace of mind, Vauxhall has an innovative Customer Care Commitment that offers the following:

- Three-year vehicle warranty consisting of a one-year/unlimited mileage manufacturer's warranty and a second and third year manufacturer's warranty with a 60,000 miles limitation
- Vauxhall Assistance for 12 months from first registration
- Six years' body panel anti-perforation warranty

Please note: Warranty is only available on vehicles sourced from Vauxhall Motors Limited. Terms and conditions apply – please see your Vauxhall Retailer for details.

VAUXHALL ASSISTANCE

Vauxhall Assistance is provided automatically with every new Vauxhall for 12 months from first registration and covers everything from accident assistance, roadside recovery and 'at home' service to flat tyres. With Vauxhall Assistance help is literally just a free* phone call away, 24 hours a day, 365 days a year!

* = Mobile phone users will be charged at their standard tariff.

PROTECTING THE ENVIRONMENT

Vauxhall's commitment to the environment is demonstrated by our products' many environmental awards. For even more information on Vauxhall's efforts to achieve an environmentally sustainable future, and how to dispose of your end-of-life vehicle, see www.vauxhall.co.uk/recycling

VAUXHALL SERVICE PLAN

- Fixed monthly payments for the plan duration
- Easy to budget and interest-free
- Genuine parts fitted by Vauxhall-trained technicians

Plus on Gold plans:

- Valet and courtesy car
- Full AA cover
- Engine flush and fuel treatments
- Litre of oil for top ups between services

Full details can be obtained from your local participating Vauxhall Retailer.

VAUXHALL INSURANCE WITH ADDED REASSURANCE

Comprehensive cover – Summary of benefits**

- Competitive premiums
- Repairs by a Vauxhall-trained technician
- Genuine Vauxhall parts, guaranteed for three years when we repair your car within our Approved Repairer Network
- Free courtesy car as standard when using an Approved Repairer†
- 24 hour claims helpline
- Personal Accident benefit
- Cover for audio equipment
- Windscreen cover

Call for a quote on 0844 463 2670††

** = The benefits listed above are for comprehensive cover only. For details of Third Party, Fire and Theft cover, please call our sales team.
† = Should your car need repairing following an accident we provide a courtesy car (subject to availability) for the duration of the repair. Only genuine Vauxhall parts are used. Terms and conditions apply.
†† = Calls may be recorded. Vauxhall Insurance is underwritten by Ageas Insurance Limited.

FOR MORE PRODUCT INFORMATION

For a brochure on any Vauxhall model (up to a maximum of three per caller) or location of your nearest Vauxhall Retailer please call **0345 600 1500**. Alternatively, details can be found on our website at www.vauxhall.co.uk

JOIN US ONLINE:



PROUD SPONSOR OF OUR NATIONAL FOOTBALL TEAMS



Privacy Policy – For full details please visit: vauxhall.co.uk/privacy

Vauxhall OnStar privacy details are available at vauxhall.co.uk/onstar

The invoice price, including delivery to Retailer, factory-fitted options, accessories fitted by the Retailer and number plates, is subject to VAT. Some feature descriptions in this guide may refer to, and some illustrations may show, optional equipment not included in the standard delivery. The information contained in this guide was accurate at the time of publication. We reserve the right to make changes in design and equipment. Please note that Vauxhall Retailers are not the agents of Vauxhall Motors Limited and are not authorised to bind Vauxhall Motors Limited by any specific or implied undertaking or representation. It is advisable to ensure that your motor insurance policy provides adequate cover for additional fitted options and accessories. The colours in this guide are only approximate actual colours. Illustrated optional equipment is available at extra charge. Availability, technical features and equipment provided on our vehicles can vary by model. For precise information on the equipment provided on our vehicles, please contact your local Vauxhall Retailer.

VAUXHALL

vauxhall.co.uk

©2017 Vauxhall Motors Limited

Published 19 December 2017 Vauxhall Motors Limited