

# Antara

2010 Models Edition 1





Antara SE

# EXPLORE...

## ...the City Limits.

If you've never been shy about exploring new territory, it's great to know that you can now go anywhere in complete confidence – with stylish design, genuine driving excitement and innovative versatility. Antara. The bold way to drive with style.

*This brochure covers Antara Exclusiv and SE models only. Some of the vehicles shown in this brochure include options and accessories available at extra cost. And not all of the features described are available on every model. So please check the Equipment section for further details. From time to time, we also offer alternative Antara models such as Special Editions which are featured in separate literature or can be found on the Vauxhall website [www.vauxhall.co.uk](http://www.vauxhall.co.uk)*

Exterior style 4

Interior style 8

Driving dynamics 10

Safety and security 12

Driver features 14

Interior features 16

Versatility 18

Antara Exclusiv 22

Antara SE 23

Accessories 24

Colours and trims 26

Equipment and technical data 28







# EXPLORE...

...your enthusiasm for creativity.

Bold lines, flowing curves and perfect proportions – Antara has the most expressive style in town. Compact, sophisticated and elegant, yet tough, dynamic and ready for an active life – with imposing alloy wheels, roof rails and protective skid plates. Be inspired by your Antara – wherever your drive takes you.





# EXPLORE ...

... your reputation for individuality.

Wherever you're headed, go your own way. Don't just be different – do it with style and purpose. Just like the Vauxhall Antara, your perfect companion.





# EXPLORE...

... your passion for the finer things in life.

The Antara interior is full of light and space, with high quality trim, premium finishes and incredible levels of equipment. Leather trim, electronic climate control, MP3 format, sat nav and heated front seats are all available. And a high driving position gives you confidence, control and a great view of the road ahead.









## Go anywhere any time.

Antara's high-tech diesel engine provides strong performance – on and off the road. Coupled with a choice of manual or automatic transmissions, it's perfectly matched to the car's sports-tuned suspension that together with a combination of intelligent four-wheel drive and electronic chassis safety systems gives an unrivalled drive.



 **Automatic transmission.** Rare for this class, a five-speed ActiveSelect® automatic transmission is available (at extra cost). Electronically controlled features include an adaptive driving function and a winter mode.



 **Manual transmission.** Antara's diesel engine comes with a slick but sturdy five-speed manual gearbox as standard.

▶ **Descent Control System.** DCS enhances driver control on slippery slopes by maintaining a constant incline descent speed. Fitted as standard equipment, it allows drivers to make potentially tricky descents far more comfortably and at safer, constant speed.



▼ **Diesel Particulate Filter (DPF).** Diesel Particulate Filters provide an effective means of reducing particulate emissions into the atmosphere. The maintenance-free Antara unit can cut the output of harmful emissions by over 90%. That's why it's standard equipment.

**2.0CDTi 16v diesel.** Delivering 150PS and 320Nm of low end torque, the Antara diesel engine features the latest common rail technology, combined with variable turbo geometry for superior performance and economy. Service intervals are every 20,000 miles or 12 months, whichever occurs soonest.

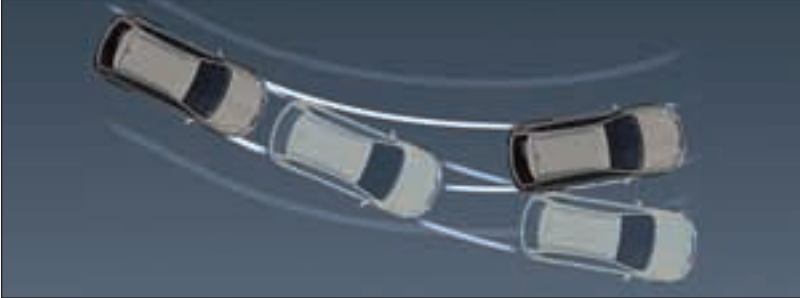

▲ **Electronic Stability Programme (ESP).** Antara benefits from a unique interaction between switchable ESP, Traction Control (TC) and Descent Control System (DCS), all working together with the intelligent four-wheel drive to deliver high degrees of driving satisfaction, comfort and active safety. If a wet roundabout or muddy corner catches you out, ESP applies corrective braking to help you regain control. TC helps maintain traction under acceleration.



**Intelligent ABS.** The Antara Anti-lock Braking System (ABS) is supported by Emergency Brake Assist, Electronic Brakeforce Distribution and Cornering Brake Control, making the car even easier to control and stop in emergency cornering and braking conditions.



◀ **Intelligent four-wheel drive.** Few of us need permanent four-wheel drive, so the electronically controlled Antara system switches automatically between two- and four-wheel drive as conditions demand. In normal driving, power goes to the front wheels only, saving fuel at the same time. And when conditions turn difficult or slippery, four-wheel drive is automatically engaged, switching the drive as required to the front and rear wheels for optimum traction.

See page 35 for more explanation of ESP, DCS and intelligent four-wheel drive.





◀ ▶ **Security features.** Remote control central deadlocking, ultrasonic security alarm system and an electronic engine deadlock immobiliser are standard. Our clever door-to-door illumination feature keeps the dipped headlights and rear lights on for 30 seconds to light your way as you leave the car.

▼ **Vauxhall ISOFIX.** The outer rear seats are fitted with secure mounting points as part of the ISOFIX child seat restraint system. Used with the Vauxhall accessory DUO ISOFIX child seat (not included), this virtually eliminates the dangers that can result from improper seat installation.

▼ **Parking distance sensors.** This clever Vauxhall system helps safeguard your car when parking. Sensors in the bumpers provide an audible warning when they sense an object behind – or in front of – the vehicle, making it altogether easier to park.



▶ **Tyre pressure monitoring system.** Antara SE permanently monitors individual tyre pressures using sensors located on the tyre valves, displaying the information on the colour monitor. If a significant pressure loss is detected, the colour monitor display identifies the offending tyre.

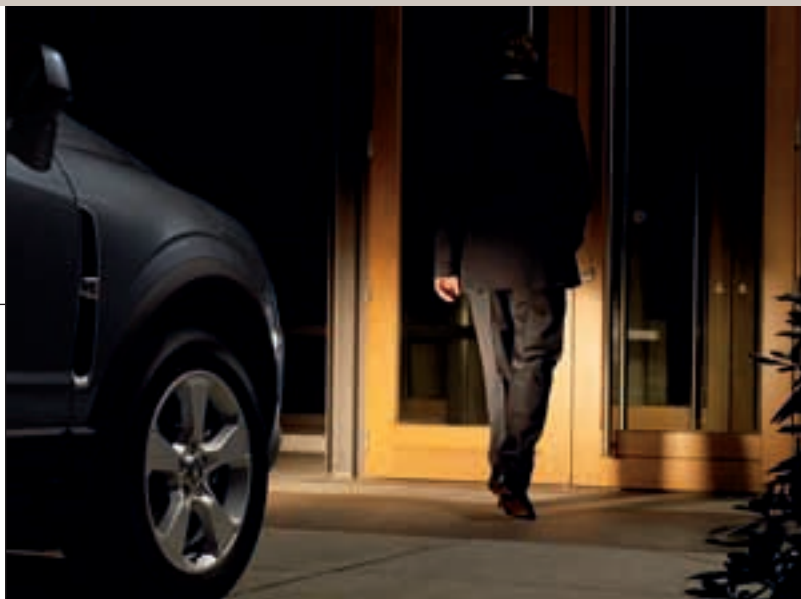

**Front lights.** For safer winter driving, front fog lights are standard on every model, recessed into the lower valance. Xenon headlights, with dynamic beam levelling and high-pressure washers, are standard on Antara SE.

▶ **Safety features.** Antara protects you in so many ways. Front, side and full-size curtain airbags are standard, along with pyrotechnic body-lock seatbelt pretensioners for the front and outer rear seats. Adaptive brake lights flash when the ABS braking is activated.





## Safety and security that surrounds you.

The Vauxhall Antara takes great care of you and your passengers. With a wide range of the latest safety features, from airbags to adaptive brake lights – even on-the-move monitoring of the tyre pressures – be assured, you are in good hands.



▼ **Sensing features.** The Antara driver environment is packed with clever ideas helping you concentrate on the road ahead. On SE activate the rain-sensitive wipers and they'll switch themselves on automatically when it rains. Automatic lighting control does the same for the headlights when it starts to get dark.

▶ **Satellite navigation.** Standard on Antara SE so you need never get lost in traffic again. The sat nav unit comes with a six-disc CD autochanger with MP3 format/stereo radio, a colour monitor and fully integrated mobile phone connectivity with voice activation and Bluetooth® wireless technology.\*



▼ **Cruise control.** Standard on all models, the easy-to-use cruise control system allows you to maintain a steady speed without keeping your foot on the throttle. So it's more comfortable on long journeys and easier to keep to speed limits too.

▶ **Seating position.** You don't just sit high up in Antara. You relax in total comfort, thanks to driver's seat height, tilt and lumbar adjustment, plus a reach and rake adjustable steering column. SE models also feature heated front seats – with three separate heat settings as standard.



*\* See the online Vauxhall Car and Accessory Price Guide for details of compatible mobile phones.*



▶ **Quality audio.** Standard on Exclusiv the CD 30 MP3 CD player/stereo radio plays MP3 tracks from CD. Antara models have seven speakers and steering wheel mounted audio controls.







 **Bluetooth®.** With Vauxhall's accessory mobile phone cradle\*, your phone interfaces with the car's audio unit, for full operation via the steering wheel controls and fascia display. Bluetooth® wireless technology with voice activation is included. Standard on Antara SE.



 **Handbrake.** The uniquely styled handbrake and passenger grab handle reflects not only Antara's premium quality level, but its sturdy SUV character. The same close attention to detail is also evident in the interior trim inserts and the detailing to the steering wheel and gear knob.



## You're in command and in control.

Antara's high driving position and commanding view are complemented by a softly sculpted fascia designed to make driving easy. Clear instrumentation and displays are matched by ergonomic positioning of all the switches and controls.



◀ **Leather trim.** Antara SE models feature stylish leather seat trim in Charcoal or Saddle Brown to suit your exterior colour. It's complemented by high gloss, wood-effect décor trim on the fascia and doors, adding to the upmarket feel.

**Heated front seats.** On all models, heating elements in the seat backs and cushions enable the front seats to reach a comfortable temperature in a very short time. There are three separate heat settings.

**Front centre armrest.** The centre console includes a comfortable armrest. Open the lid and you'll find more storage space for loose items like sweets, coins, CDs and other personal effects.



▶ **Rear drinks holders.** Conveniently mounted at the rear of the centre console, the two pop-out drinks holders are the perfect place for en-route refreshments, and typical of Antara's attention to rear passenger comfort. The whole unit can be stored conveniently away when not in use.



▶ **Heat-reflective windscreen.** The SE features a multi-layered coating inside the windscreen which reflects the sun's heat, helping the electronic climate control maintain a pleasant – and constant – temperature inside the car.

▶ **Centre console waste container.** The removable waste container – with lid – is yet another neat Antara idea, making it easier to keep the car tidy. Available on Exclusiv models it mounts conveniently in one of the two centre console drinks 'indents', easily within reach, next to the handbrake.



▶ **60/40 split-folding rear seat.** Antara models feature a 60/40 split-folding rear seat with adjustable backrest. Tilted forward into the upright position, these provide extra usable luggage capacity.





▲ ▼ **Air conditioning and ECC.**

Standard on Antara Exclusiv, air conditioning makes for a fresher interior atmosphere all year round. The SE moves up to Electronic Climate Control enabling you to maintain the interior temperature to within a single degree, and even keep your drinks cooled inside the glovebox.



## Take it easy in style and comfort.

Inside Antara you'll find premium comfort and convenience blended with contemporary style. A comprehensive range of available features will make you and your passengers feel at home. Sit back and enjoy the ride.





## As versatile as you want to be.

Maximum flexibility inside – numerous possibilities outside. Clever use of interior space, coupled with some equally smart feature innovations ensure that the Antara load area is not just capacious, but hugely versatile.

◀ ▼ **FlexOrganiser®.** Antara is pre-fitted with mounting points for our innovative accessory FlexOrganiser® system – side rails with sliding hooks and specially devised storage nets and pockets. With all your belongings safe in predefined compartments, it's the smart, versatile way to manage your load area.



▲ **Spacious load area.** Open the tailgate. Enjoy the space. An incredible 1420 litres of loadspace to be exact – with the rear seats folded forward. Even with all five seats in use, and the luggage compartment cover in place, a 928mm long floor length translates to as much as 370 litres of loadspace – easily enough for several large suitcases. If you need room for longer luggage, the rear seat back is 60/40 split-folding, so you can carry what you need and still have room for rear seat passengers.



▲ **Roof rails.** Antara's stylish silver-effect integral roof rails don't just look good. They're the perfect starting point for the Vauxhall roof rack system. Attach the accessory base carrier and it's ready for a wide range of lockable travel boxes and other specialist fittings for skis and more.



◀ **Practical stowage.** Antara has plenty of clever storage space. In the front you'll find door pockets, drinks holders, a sunglasses storage pocket, passenger seat undertray and storage in the front centre armrest. There are drinks holders and front seat back storage pockets for rear passengers too.





Antara SE



# EXPLORE...

... your flair for individuality.

Antara is all about going your own way, and that extends to model choice – choose between the well-equipped Antara Exclusiv and the high-spec Antara SE with premium leather trim and satellite navigation as standard. Add a further choice of practical accessories and stylish colours and it's easy to make your Antara the perfect companion for an individual lifestyle.

**ANTARA EXCLUSIV**

**Standard features include:**

- Intelligent four-wheel drive
- Switchable Electronic Stability Programme (ESP) with traction control
- Anti-lock Braking System (ABS)
- Descent Control System (DCS)
- Driver's and front passenger's airbags
- Front seat side-impact airbags
- Front and outer rear seat full-size curtain airbags
- Air conditioning
- Door-to-door illumination
- Steering column adjustable for reach and rake
- Three-spoke leather-covered steering wheel
- Front fog lights
- Cruise control
- Parking distance sensors front and rear
- Dark-tinted glass (excludes windscreen and front door windows)
- Automatic self-levelling rear suspension
- Retractable luggage compartment cover
- Silver-effect roof rails
- Electrically adjustable/heated door mirrors
- CD player with MP3 format/stereo radio (CD 30 MP3)
- 18-inch alloy wheels with 235/55 R 18 ultra-low profile tyres

Engine availability	Insurance groups (ABI)	
	20	50
2.0CDTi 16v manual	10E	19E
2.0CDTi 16v automatic	10E	19E

*Please note: Insurance groups relate to both the previous 20 group rating and the new 50 group rating.*



 **Air conditioning.**

*Two-coat metallic paint is optional at extra cost.*



 Xenon headlights.



Two-coat metallic paint is optional at extra cost.

**ANTARA SE**

**Additional features over and above Antara Exclusiv:**

- Trip computer
- Electronic Climate Control (ECC)
- Rear seat centre armrest
- Cooled glovebox
- Automatic lighting control
- Rain-sensitive windscreen wipers
- Heat-reflective windscreen
- Twin illuminated vanity mirrors
- Chrome-effect exterior door handles
- Leather-covered gear knob
- Front passenger's seat with fold-flat facility
- Satellite navigation system with colour monitor/six-disc CD autochanger with MP3 format/stereo radio
- Mobile phone system with Bluetooth® and base plate (does not include phone or cradle)
- Xenon headlights with dynamic beam levelling and high-pressure headlight washers
- Electro-chromatic anti-dazzle rear-view mirror
- Electrically foldable door mirrors (anti-dazzle on driver's side)
- Leather seat facings
- Tyre pressure monitoring system

Engine availability	Insurance groups (ABI)	
	20	50
2.0CDTi 16v manual	12E	24E
2.0CDTi 16v automatic	12E	24E

*Please note: Insurance groups relate to both the previous 20 group rating and the new 50 group rating.*



Vauxhall accessories are the right choice for your Antara. Whatever you're into, there's certain to be a Vauxhall accessory with your name on it; all fitted by trained Vauxhall professionals. We've only featured a small selection of what's available here. The Vauxhall Car Accessories Brochure gives further details.

▶ **Reversible anti-slip cargo mat.**

Our strong and sturdy Charcoal-coloured cargo mat is tailor-fitted to the luggage compartment and perfectly matches the car's interior. Reversible design features carpet with Antara lettering on one side, and easy-to-clean anti-slip surface on the other.



◀ **Aluminium base carrier.**

The Vauxhall roof rack system begins with this lockable aluminium base carrier, comprising two T-track roof bars which support a wide range of attachments, including bicycle carriers and sport roof box (illustrated far left).



▶ **Velour and rubber floor mats.**

Hard wearing and easy to fit, our choice of velour or rubber Charcoal floor mats are the best way to protect your car's interior.



◀ **Detachable coupling tow bar with 12N electrics.** If you want a tow bar coupling that can be removed from your vehicle when you're not towing, this is the choice for you. The coupling is easily mounted and detached for maximum convenience.



## VAUXHALL ACCESSORY PACKS

Vauxhall accessory packs bring together a selection of essential accessories at great prices, helping you to protect your car and equipping you for roadside emergencies.

### ▼▶ Protection Pack.

- Velour floor mats
- Mudflaps
- Cargo liner



### ▶ Travel Pack.

- First aid kit
- Warning triangle
- Hi-visibility vest



*Irmscher*

Developed in conjunction with auto design specialists Irmscher International, Antara styling accessories perfectly complement the vehicle's lines, and are manufactured to the same exacting standards as the car itself. The model illustrated features Irmscher body-colour front lower spoiler, cross hatch grille with aluminium upper and laser-etched 'Irmscher' logo, stainless steel side running boards, body-colour rear roof spoiler and 20-inch Evo Star alloy wheels (also available in black).

- ▼▶ **Irmscher Styling Pack A.** Includes stainless steel side running boards, body-colour rear roof spoiler (illustrated below) and Irmscher tax disc holder.

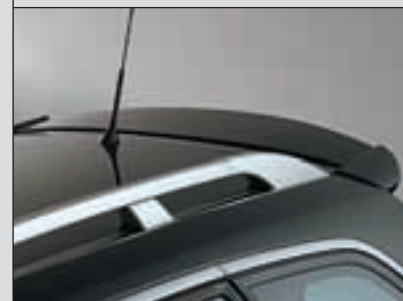

Show your true colours. Antara is available in a carefully selected range of paint and interior finishes. All our colours and seat trims, including the premium leather upholstery, are designed to perfectly complement Antara's dynamic and stylish personality.

*Due to the limitations of the printing process the colours reproduced may vary slightly from the actual paint colour or trim material. As a result they should be used as a guide only. Your Vauxhall retailer has a comprehensive display of all our paint samples and trim swatches.*



▶ Trim: Vicker cloth/Morrocana, Charcoal

◀ ▶ Trim: Leather, Saddle Brown

▶ Trim: Leather, Charcoal





Exterior colours

Model, trim name and trim colour

	Exclusiv Vicker cloth/Morrocana	SE Leather
<b>Standard</b>		
Olympic White	Charcoal	Charcoal
<b>Two-coat metallic (optional at extra cost)</b>		
Sovereign Silver	Charcoal	Charcoal
Placid Grey	Charcoal	Charcoal or Saddle Brown
Linen Beige	Charcoal	Charcoal
Carbon Black	Charcoal	Charcoal or Saddle Brown
<b>Two-coat pearlescent (optional at extra cost)</b>		
Ivory White	Charcoal	Charcoal

▶ Olympic White



▶ Sovereign Silver



▶ Placid Grey



▶ Linen Beige



▶ Carbon Black



▶ Ivory White



## Contents

### Equipment

Safety Security	28
Facia, instruments and controls Interior features Heating and ventilation	29
Wheels and tyres Mechanical features Exterior features	30
Audio, communications and navigation	31
<b>Technical data</b>	
Engines Performance, fuel economy and emissions	32
Vauxhall Assistance and warranties Optional transmission Steering Suspension Brakes Body Fuel tank capacity	33
Exterior dimensions Luggage capacities Loadspace dimensions Weights and towing data	34
Features explained	35

## Safety

**Standard features** • Driver's airbag • Front passenger's airbag • Front seat side-impact airbags • Full-size curtain airbags • Energy-absorbing steering column • Pedal release system – Reduces potential injury to the driver's legs and feet during a severe frontal impact • Laminated windscreen • Side-impact protection beams • Integral protective side door padding • Reinforced passenger safety cell • Deformation zones front and rear • Burst-proof door locks and anti-jam door design • Child-proof locks on rear doors

• **ISOFIX child seat restraint system for outer rear seats (does not include child seat)** – Secures ISOFIX child safety seats to the vehicle itself, virtually eliminating the dangers that can result from improper installation

• **Switchable Electronic Stability Programme (ESP) with traction control** – see **D1** on page 35 • **Anti-lock Braking System (ABS)** • **Electronic Brakeforce Distribution** – Distributes the braking force between the wheels most able to use it, allowing stable and efficient braking • **Cornering Brake Control** – see **D2** on page 35 • **Emergency Brake Assist** – Increases applied brake force in emergency braking situations • **Descent Control System** – see **D3** on page 35 • **Trailer stability programme** • **Adaptive Brake Lights** – If the driver brakes hard enough to activate the ABS the brake lights flash on and off at the rate of four times per second, thus warning following vehicles that heavy braking is in progress

• **Height-adjustable front and outer rear seat head restraints** • **Pyrotechnic front and outer rear body-lock seatbelt pretensioner system** – Tightens the seatbelt during the early stages of a frontal impact • **Front and outer rear seatbelt force limiters** – Reduce potential upper body injuries during a frontal impact • **Anti-submarining ramps in all seats** – Help prevent occupants sliding underneath the lap belt during a collision

### Additional features

	Exclusiv	SE
Tyre Pressure Monitoring System		●
Electronic park/brake pedal safety interlock on models with automatic transmission	●	●

## Security

**Standard features** • Remote control ultrasonic security alarm system • Remote control two-stage central deadlocking (doors, tailgate, fuel filler flap) • Visible Vehicle Identification Number (VIN) plate • Electronic engine deadlock immobiliser • Electronic theft protection for audio equipment • Driver's internal central locking switch • Freewheeling driver's door lock • Door-to-door illumination – Keeps the headlights and rear lights on for 30 seconds after the car doors are locked • Retractable luggage area cover • Folding key • Locking wheel nuts

## Facia, instruments and controls

**Standard features** • Cruise control • Multi-function display showing time, date, audio information and outside air temperature (with ice warning function) • Rev counter • Digital clock with automatic RDS time adjustment • Black instruments with chrome edging • Leather-covered three-spoke steering wheel • Steering column adjustable for reach and rake • Electronic odometer and trip odometer • Instrument panel light dimmer • Handbrake-on/low brake fluid level and low fuel level warning lights • Service interval monitor • Cigar lighter and front ashtray

<b>Additional features</b>	Exclusiv	SE
Multi-function trip computer		●
Leather-covered gear knob		●

## Interior features

**Standard features** • Driver's seat with reach, rake, height and lumbar adjustment • Lidded glovebox • Charcoal metallic-effect centre console • 12-volt auxiliary power socket within centre console • Front centre armrest with storage facility • Chrome-effect interior door handles • Colour-keyed fleece velour carpet • Front door pockets • Front passenger's underseat storage tray • Map pockets on front seat backs • Drinks holders in rear centre console • FlexOrganiser® rails in sides of luggage area • Fully carpeted and illuminated luggage area • Front map reading lights integral with courtesy light • Rear reading lights • Driver's sunglasses holder • Fade up/fade down courtesy lighting operated by door switches • 60/40 split-folding rear seat back • Adjustable rear seat backrest

<b>Additional features</b>	Exclusiv	SE
Twin sunvisors incorporating front passenger's vanity mirror with cover	●	
Twin sunvisors incorporating illuminated driver's and front passenger's vanity mirrors with covers		●
Drinks holders in front centre console	●	
Electro-chromatic anti-dazzle rear-view mirror		●
Morrocana-trimmed side bolsters on front and rear seats	●	
Leather seat facings		●
Electrically heated front seats with variable temperature settings		●
Front passenger's seat with fold-flat facility		●
Rear seat centre armrest with storage compartment		●
Brushed steel-effect inserts on facia and doors	●	
Wood-effect inserts on facia and doors		●

## Heating and ventilation

**Standard features** • Interior pollen filter • Air recirculation with activation light • Air blend heater with four-speed fan

<b>Additional features</b>	Exclusiv	SE
Air conditioning	●	
Electronic Climate Control (ECC) incorporating cooled glovebox		●



Front centre armrest with storage facility.



Drinks holders in rear centre console.





18-inch Exclusiv alloy wheel.



18-inch SE alloy wheel.



Xenon headlights with high-pressure washers.

## Wheels and tyres

### Features

	Exclusiv	SE
18-inch 5-twinspoke alloy wheels with 235/55 R 18 ultra-low profile tyres	●	
18-inch five-spoke alloy wheels with 235/55 R 18 ultra-low profile tyres		●
Steel space-saver spare wheel/tyre	●	●

### Mechanical features

#### Features

	Exclusiv	SE
Intelligent four-wheel drive – see <b>D4</b> on page 35	●	●
Sports-tuned suspension	●	●
Automatic self-levelling rear suspension	●	●
Diesel particulate filter	●	●
Five-speed manual gearbox	●	●
Five-speed automatic transmission	○	○

### Exterior features

**Standard features** • Dark-tinted glass (excludes windscreen and front door windows) • Front and rear parking distance sensors • Heated rear window with automatic timed cut-off • Intermittent rear window wash/wipe • Tinted glass • Electrically operated front and rear windows with driver's safety autoreverse and one-touch facility • Body-colour door mirrors • Electrically adjustable/heated door mirrors (wide-angle on driver's side) with automatic timed cut-off • Chrome-effect window trim • Silver-effect roof rails • Front and rear alloy-effect protective skid plates • Two-tone horn • Front fog lights • Lights-on audible warning • Twin gas-assisted tailgate struts

#### Additional features

	Exclusiv	SE
Body-colour door handles	●	
Chrome-effect door handles		●
Alloy-effect door sill covers		●
Electrically foldable door mirrors, anti-dazzle on driver's side		●
Heat-reflective windscreen		●
Rain-sensitive windscreen wipers		●
Automatic Lighting Control		●
Chrome-effect exhaust tailpipe		●
Dual Ellipsoidal headlights	●	
Xenon headlights with dynamic beam levelling and high-pressure headlight washers		●
Two-coat metallic or pearlescent paint	○	○

## Audio, communications and navigation

Features	Exclusiv	SE
<b>CD player with MP3 format/stereo radio (CD 30 MP3)</b> <ul style="list-style-type: none"> <li>• CD player with MP3 format</li> <li>• Auxiliary-in socket</li> <li>• AM/FM stereo radio with 24 station presets</li> <li>• RDS with Traffic Programme</li> <li>• Remote display</li> <li>• 20 watts per channel output</li> <li>• 7 speakers</li> </ul>	●	
<b>Satellite navigation/CD autochanger with MP3 format/stereo radio (DVD 100)</b> <ul style="list-style-type: none"> <li>• Satellite navigation system</li> <li>• Six-disc CD autochanger with MP3 format</li> <li>• Auxiliary-in socket</li> <li>• AM/FM stereo radio with 40 station presets</li> <li>• Remote colour monitor</li> <li>• RDS with Traffic Programme</li> <li>• 20 watts per channel output</li> <li>• 7 speakers</li> </ul>		●
Steering wheel mounted audio controls	●	●
Mobile phone system with Bluetooth® and base plate system (does not include phone or phone-specific cradle)		●

### Satellite navigation

The DVD 100 satellite navigation system uses the international network of GPS (Global Positioning System) satellites, linked to a comprehensive mapping system, to determine your precise location and guide you to your chosen destination virtually anywhere in mainland Britain. It also offers trunk road navigation across many European countries.

Entering your destination has never been easier, so you can start your journey quickly and without fuss, and it's just as simple to use when on the move. The colour monitor has a split-screen facility, which displays half the screen as a route map while the other half shows directional arrows to give immediate information about road junctions. You can even plan your route to avoid toll roads.

DVD 100 includes a travel guide that allows you to browse details of restaurants, hotels and other points of interest. These details can include information such as pictures, addresses and telephone numbers.

Selecting your desired destination enters it straight into the navigation system. The DVD 100 also features Traffic Message Channel (TMC), a specific application of RDS used for broadcasting real-time traffic information, delivered to the driver either visually or verbally. TMC can also offer dynamic route guidance – alerting the driver to a problem on the planned route and calculating an alternative route to avoid the incident.

### Auxiliary-in socket

The auxiliary-in socket allows you to connect your portable MP3 music player directly into the car's audio system. All you need is your music player and a suitable connecting lead and you can listen to all your favourite tunes through your car's speaker system. Using your MP3 music player in the car couldn't be easier – use it to select the music, as you would normally do, while controlling the volume via the car's regular volume controls.

### Mobile phone system with Bluetooth®

Vauxhall's factory-fit dual-band mobile phone system is fully integrated into the audio and communication system. It features voice control and will connect wirelessly to phones with Bluetooth® technology.

All the required information is displayed on the colour monitor when a mobile phone is in use, while the menus are easily navigated by either the steering wheel audio controls or the multi-function button on the radio. Certain functions can also be controlled by voice activation.

Mounted on the centre console, the phone system base unit can be fitted with phone-specific cradles (available as accessories) for many different mobile phones. A list of compatible cradles is featured in the online Vauxhall Car and Accessory Price Guide.



Steering wheel mounted audio controls.

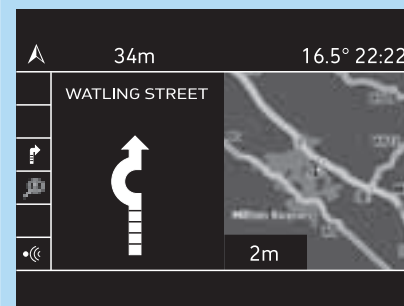

DVD 100 satellite navigation system, showing the split-screen facility.

Vauxhall supporting



### Smarter driving tips

- Drive at an appropriate speed: – Staying within the speed limit increases driver safety, reduces CO<sub>2</sub> emissions and saves fuel. At 70mph you could be using up to 9% more fuel than at 60mph and up to 15% more fuel than at 50mph
- Drive smoothly at all times: – Anticipate the ebb and flow of the traffic to avoid harsh acceleration and braking
- Reduce your revs: – Change gear earlier to help reduce fuel consumption – try 2000 rpm with diesel engines
- Idling is wasting fuel: – If you're likely to be at a standstill for more than three minutes, switch off the engine to save fuel
- Regularly check your tyre pressures: – Under inflated tyres increase CO<sub>2</sub> emissions whilst incorrectly inflated tyres can be unsafe. Always check your handbook for the correct tyre pressure. This will also help to increase the life of your tyres
- Remove unnecessary items from the car: – Extra weight increases the engine's workload, whilst roof racks and bike carriers increase wind resistance. All burn more fuel and increase CO<sub>2</sub> emissions

### Engine

	<b>2.0CDTi 16v ECOTEC-4 Turbo diesel with Diesel Particulate Filter (DPF)</b>
Capacity	1991cc
Maximum power	150PS (110kW) @ 4000rpm
Maximum torque	320Nm (236 lb.ft.) @ 2000rpm
Configuration	4 cylinders, 4 valves per cylinder, single overhead camshaft
Fuel/induction system	Variable geometry turbocharger with intercooler. Common rail fuel injection
Service intervals	20,000 miles or 1 year (whichever occurs sooner)
<b>Benefit in kind company car taxation – 2009/10 tax year</b>	
Manual	30%
Automatic	35%

### Performance, fuel economy and emissions

	Performance (manufacturer's figures)		Fuel economy mpg (litres/100km)			CO <sub>2</sub> emissions (g/km)
	Maximum speed (mph)	Acceleration 0-62mph (secs)	Urban driving	Extra-urban driving	Combined figure	
2.0CDTi 16v	111	11.1	32.5 (8.7)	41.5 (6.8)	37.2 (7.6)	198
2.0CDTi 16v automatic	110	12.8	25.9 (10.9)	38.7 (7.3)	32.8 (8.6)	225

The fuel consumption figures shown comply with EC directive 1999/100 to provide a realistic indication of fuel consumption by taking into account everyday driving conditions, such as cold starts, acceleration, braking and even differences in the weight of models with the same engine. **Important:** the results given relate to the particular car tested; inevitably there are differences between individual cars of the same model. In addition, some cars may incorporate particular modifications. Driving style, road and traffic conditions, vehicle mileage and standard of maintenance may also affect fuel consumption; therefore the results do not express or imply any guarantee of the fuel consumption attainable.



## Vauxhall Assistance and warranties\*

- All new Vauxhalls qualify for a three-year vehicle warranty consisting of a one year/unlimited mileage manufacturer's warranty and a second and third year manufacturer's warranty with a 60,000 miles limitation
- Vauxhall Assistance for 12 months from first registration
- Six years' body panel anti-perforation warranty

\* = Warranty is only available on vehicles sourced from General Motors UK Limited. Terms and conditions apply – please see your Vauxhall retailer for details.

## Optional transmission

### Five-speed automatic transmission with Active Select function:

Available at extra cost. Electronically controlled with adaptive driving function and winter mode. Fluid drive with torque converter, lock-up clutch and Active Select.

## Steering

- Speed-sensitive power-assisted steering
- Turning circle (kerb-to-kerb): 12.4m (40.7ft.)

## Suspension

**Front:** Independent. Lightweight MacPherson struts with gas-pressure dampers and coil springs. Anti-roll bar.  
**Rear:** Independent. Multi-link with coil springs and gas-pressure dampers. Automatic self-levelling rear suspension system integrated within the dampers, requiring no external power source.

## Brakes

- Anti-lock Braking System (ABS)
- Dual circuit, diagonally split braking system

### All models

Front ventilated discs: 296mm diameter  
Rear ventilated discs: 303mm diameter

## Body

- Aerodynamic drag co-efficient: Cd 0.38

## Fuel tank capacity

65 litres (14.3 gallons).



Rear suspension includes automatic self-levelling.



Diesel Particulate Filter (DPF).

Exterior dimensions millimetres (inches)

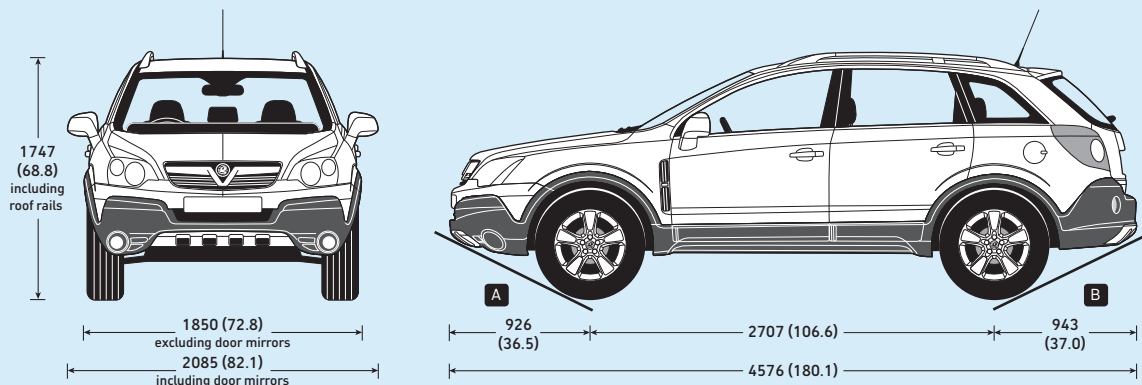

Off-road capabilities

Max. ground clearance  
200mm (7.9 inches)

Max. wading depth  
450mm (17.7 inches)

Max. approach angle **A**  
24°

Max. departure angle **B**  
16°

Max. ramp angle  
14°

Luggage capacities (measured using the ECIE method)

	litres	cu.ft.
Rear seats up (under luggage compartment cover)	370	13.1
Rear seats folded (to upper edge of front seat back)	865	30.5
Rear seats folded (to roof)	1420	50.1

Loadspace dimensions

	mm	inches
Maximum length (behind rear seats)	928	36.5
Maximum length (rear seats folded)	1740	68.5
Maximum width	1320	52.0
Width between wheel arches	967	38.1
Loading height	828	32.6

Weights and towing data kg

	Gross vehicle weight	Max. towing weights Trailer with brakes (without brakes)
Manual models	2505	2000 (750)
Automatic models	2505	1700 (750)

**Gross vehicle weight** is the total permissible weight of the vehicle including passengers and their luggage. The **maximum roof rack loading** should not exceed 100kg. The **maximum towing weights** are based on the ability of the car, with two occupants of 75kg each, to restart on a 12% gradient, which is approximately 1 in 8.3, at sea level. At altitudes above 1500 metres, the engine output may drop with a corresponding reduction in towing capability. Any extra weight, such as luggage or additional passengers, should be deducted from the maximum towing weight. With a trailer fully loaded, **maximum noseweight** should not exceed 80kg. Always fit Vauxhall towing attachments and accessories available from your Vauxhall retailer. They are designed specifically for Vauxhall models and carry a 12-month guarantee.

## Features explained

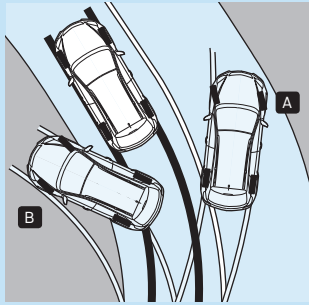

### D1. Switchable Electronic Stability Programme (ESP)

ESP helps the driver maintain full control of the vehicle during adverse or emergency conditions. ESP technology is designed to monitor both the front and rear of the car independently and compare their respective directions of travel with the driver's steering wheel input. If either the front **A** (understeer) or rear **B** (oversteer) of the vehicle begins to slide, ESP gently applies corrective braking to the appropriate individual road wheel, controlling the slide and maintaining safe progress.

**A** When a vehicle is understeering excessively, ESP will apply a braking force to the inside rear wheel, slowing it down and increasing the vehicle's yaw angle to help the front wheels change direction. **B** During the more unusual oversteering situation, ESP will apply the correct braking force to the outside front wheel, which will reduce the yaw angle and bring the vehicle back under control. The system fitted to Antara can be switched off for those situations where a certain amount of wheelspin is desirable in order to maintain forward or backward motion – such as on snow or especially slippery ground.

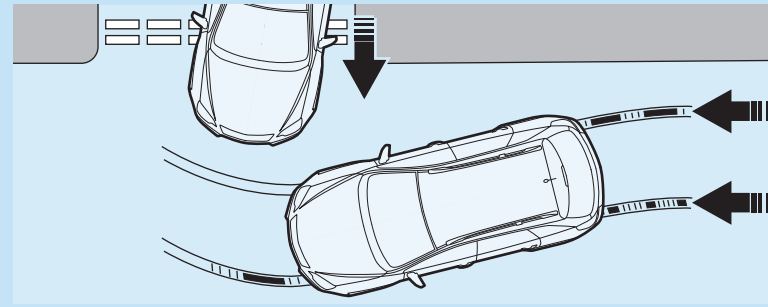

### D2. Anti-lock Braking System (ABS) with cornering brake control

Cornering brake control makes the car easier to control in extreme situations, particularly when braking sharply on a bend. It is particularly effective when carrying out emergency procedures, such as avoiding a child's ball that's rolled out from the kerb. The system works by sensing the different rotational speeds of the individual road wheels and co-ordinating the level of braking pressure applied to each wheel. Cornering brake control is an integral part of Antara's comprehensive ABS.

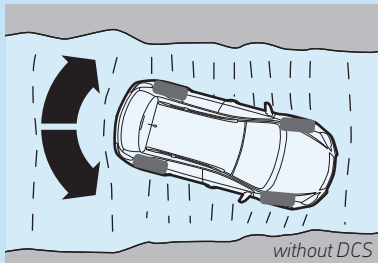

without DCS

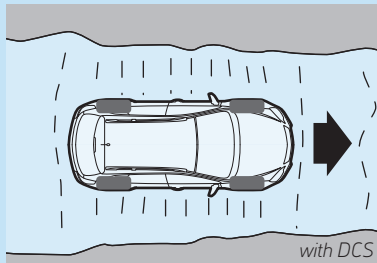

with DCS

### D3. Descent Control System (DCS)

DCS allows controlled descent on downward slopes without locking the wheels. Operating at speeds up to 30mph the system uses the ABS sensors to monitor wheel speed and brakes automatically without locking the wheels. On severe inclines the system also allows for a more controlled descent at a constant 6mph by braking the front wheels. This low-speed descent is activated by selecting first gear (D for automatic transmission) while stationary at the top of the slope and then allowing the vehicle to roll forward (without using the accelerator) and then activating the DCS button. The system also operates in reverse gear, though at a slightly lower speed.

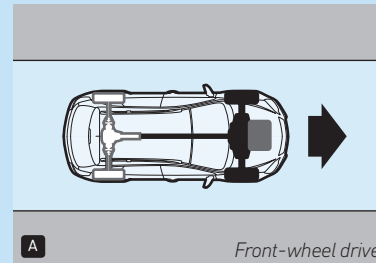

**A**

Front-wheel drive

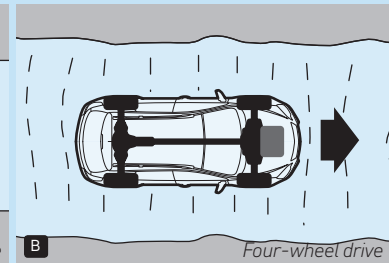

**B**

Four-wheel drive

### D4. Electronically controlled four-wheel drive coupling

This electro-hydraulic coupling is at the heart of Antara's intelligent four-wheel drive system. It reacts to road conditions through inputs from the ESP, ABS and traction control sensors. Under normal conditions **A** Antara operates in front-wheel drive mode for optimum efficiency. However, as soon as the sensors indicate that four-wheel drive is necessary **B** a precise electrical charge is applied to the coupling which then delivers the correct amount of torque to the rear wheels within milliseconds.

In extremely slippery conditions it enables the power to be split 50:50 between the front and rear axles for maximum traction.



# Trust Vauxhall

## Protecting the environment

Vauxhall's commitment to the environment is demonstrated by our products' many environmental awards, won both through the use of more recycled materials and by becoming cleaner and more efficient. For information on Vauxhall's efforts to achieve an environmentally sustainable future, see [www.vauxhall.co.uk/recycling](http://www.vauxhall.co.uk/recycling)

## Fleet Customer Services

Our dedicated support services for fleet managers includes factory demonstrators, a three-day test drive programme and information on whole life costs, company car taxation and finance. For further information please call **0870 010 0651**.

## Buying your car

GMAC offers one of the most comprehensive and competitive ranges of financing plans in the UK. Contact your local Vauxhall retailer for details or call the GMAC customer service centre on **0845 712 3444**.

## Vauxhall Extended Warranty

For complete peace of mind Vauxhall offers an extended warranty that can be purchased on an annual basis following the expiry of the original new car warranty. It covers most mechanical and electrical components. Terms and conditions apply, for further details please contact your local Vauxhall retailer.

## Specialist Mobility advice

Motability accredited Vauxhall retailers can provide special mobility help and advice. Blue badge holders are entitled to very favourable discounts on new vehicles. Contact your local Motability accredited Vauxhall retailer or **Freefone 0800 731 5267**.

## Servicing and maintenance

The best way to maximise the performance and reliability of your Vauxhall is to have all routine servicing and maintenance carried out at one of around 400 Vauxhall retailers. To find your nearest retailer call **0845 600 1500**.

## In the event of an accident...

Vauxhall Accident Support helps keep you mobile following an accident. Benefits include scene-of-accident advice, message service, assistance with claims and vehicle recovery. For further details call **0800 010 304**.

## Vauxhall Insurance

Available for new and used Vauxhalls, a Vauxhall Insurance policy offers a unique package designed specifically for Vauxhall drivers. For a highly competitive quotation, call **0844 84 85 840 (Great Britain) or 0845 35 13 410 (N. Ireland)**. Or just visit our website at [www.vauxhall.co.uk](http://www.vauxhall.co.uk)

## For more information...

For a brochure on any Vauxhall model (up to a maximum of three per caller) or location of your nearest Vauxhall retailer please **Lo-call 0845 600 1500**.

Alternatively, details can be found on our website at [www.vauxhall.co.uk](http://www.vauxhall.co.uk)



- Save up to **£1500\*** on a new Vauxhall with The GM Card
- **100 Rebate Points worth £100** when you use The GM Card for the first time
- Rebate Point saving is on top of any discount or offer negotiated with the Retailer
- Earn **3 Rebate Points (£3)** for every **£100** you spend

**Typical 14.9% APR variable**

To apply call **0845 746 2777** or visit [www.gmcard.co.uk](http://www.gmcard.co.uk)



When you have finished with this brochure please recycle it

The GM Card is issued by HFC Bank Limited and is available to persons aged 18 years or over and resident in the UK (or 21 and over in the Channel Islands) and is subject to status and conditions. Written quotations are available upon request from The GM Card, PO Box 3615, Birmingham B3 2RJ. The typical APR quoted is the rate for new customers. Rebate Points are earned on purchases using The GM Card. Rebate Points are not earned on Balance Transfers or Cash Advances. You earn money off a new Vauxhall/Saab by accumulating Rebate Points under the Rebate Points Programme. General Motors UK Limited is solely responsible for the operation of the Rebate Points Programme, which is subject to the Rebate Points Programme Rules. \*You can redeem up to 2500 Rebate Points subject to the Model Line Maximum which will vary in amount in relation to different Vauxhall/Saab vehicle model lines and unlimited Partner Points. Rebate Points and unlimited Partner Points are redeemable as discounts on a new Vauxhall/Saab vehicle and must be redeemed four years from the issue date. Rebate Points may not be redeemed by Motability Contract Hire customers. The GM Card is a trading name and style of both HFC Bank Limited and General Motors UK Limited. HFC Bank registered in England. No. 1117305. Registered Office: North Street, Winkfield, Windsor Berkshire SL4 4TD is authorised and regulated by the Financial Services Authority. Member HSBC Group. HFC Bank Limited is not a member of the same group of companies as General Motors UK Limited, Saab GB Limited or GMAC UK plc. General Motors UK Limited. Registered Office: Griffin House, Osborne Road, Luton, Bedfordshire LU1 3YT. Registered in England number 135767. - CN6/0987.

Every effort has been made to ensure that the contents of this publication were accurate and up-to-date at the time of going to press (August 2009). Vauxhall vehicles are equipped with components manufactured by various General Motors operating units and outside suppliers. The Company reserves the right to alter specifications and withdraw products from sale without notice. Any such alterations will be notified to Vauxhall retailers at the earliest opportunity, please consult your local retailer for the latest information. The specifications detailed within this brochure are not necessarily applicable to alternative models such as Special Editions. Details of any such models will be contained in specific literature or found on the Vauxhall website. Please note that Vauxhall retailers are not the agents of General Motors UK Limited and are not authorised to bind the Company by any specific or implied undertaking or representation. It is advisable to ensure that your motor insurance policy provides adequate cover for additional fitted options and accessories. Please note accessories shown are for illustrative purposes only. As part of Vauxhall's policy of environmental care, this brochure is printed on paper manufactured using Elemental Chlorine Free pulps from specially farmed, sustainable timber resources. All rights reserved. No part of this publication may be reproduced in any form or by any means, without the prior written permission of General Motors UK Limited.

