

CASCADA

PRICE/SPECIFICATION GUIDE

1 April 2018 | Model Year 2018.5



Contents:

Model Year 2018.5 (pages 2-17)

Pre-current Model Year (pages 19-34)



VAUXHALL



CASCADA RANGE HIGHLIGHTS AND PRICES

SE £28,025

- OnStar
- Dual-layered fabric roof
- Remote control roof operation
- Electronic Stability Programme-Plus (ESP-Plus)
- Driver's and front passenger's airbags
- Front seat side-impact airbags
- Active rollover protection system
- Active-safety front seat head restraints
- Tyre pressure monitoring system
- Daytime running lights
- 18-inch alloy wheels
- Air conditioning
- CD 600 IntelliLink CD/MP3 CD player with colour monitor
- Aux-in socket
- Digital radio
- USB connection with iPod control
- Bluetooth® mobile phone system
- Bluetooth® audio streaming
- Three-spoke leather-covered steering wheel
- Cruise control
- Steering wheel mounted audio controls
- Sports front seats
- Electrically operated front and rear windows
- Rear parking distance sensors
- LED rear lights
- Remote control alarm system
- Remote control central deadlocking
- Dual-tone horn
- Driver's and front passenger's seat height adjuster
- Steering column adjustable for reach and rake
- FlexFold rear seats with remote electrical release
- Storage pockets on front seat backs
- Multi-function trip computer
- Electric parking brake

ELITE £31,350-£34,135

- Features over SE**
- 20-inch 5-twinspoke bi-colour alloy wheels
 - Dual-zone electronic climate control
 - Perforated solar heat-reflective leather seat facings
 - Heated front seats
 - Ergonomic sports front seats with extendable seat cushions
 - Front seats with tilt and four-way electrical lumbar adjustment
 - Three-spoke perforated leather-covered flat-bottomed heated steering wheel
 - Rain-sensitive windscreen wipers
 - Automatic lighting control with tunnel detection and digital high beam assist
 - Electro-chromatic anti-dazzle rear-view mirror
 - Front fog lights
 - Electronic front seatbelt presenters
 - Windbreak
 - Ambient lighting in doors
 - Driver's and front passenger's sunvisors with illuminated vanity mirrors

Model	Price (£)	VAT (£)	Total (£)	On-the-road RRP (£)	CO ₂ (g/km)
2-door convertible					
SE 					
1.4i Turbo (140PS) S/S	22295.83	4459.17	26755.00	28025.00	151
ELITE 					
1.4i Turbo (140PS) S/S	25066.67	5013.33	30080.00	31350.00	151
1.6i Turbo (170PS) auto	27125.00	5425.00	32550.00	34135.00	176
1.6i Turbo (200PS) S/S	26400.00	5280.00	31680.00	32950.00	158
<i>Diesel</i>					
2.0CDTi (170PS) S/S BlueInjection*	26862.50	5372.50	32235.00	33195.00	129

Please note: On-the-road recommended retail prices (RRP) include number plates and delivery to Retailer of £700.00 (inc. £116.67 VAT), 12 months' Vehicle Excise Duty and new vehicle first registration fee of £55.00. Excludes fuel and insurance.

* = This engine features new BlueInjection technology. For more information, visit www.vauxhall.co.uk/blueinjection

CASCADA FEATURES/OPTIONS

SAFETY

Standard features

Airbags: • Driver's airbag • Front passenger's airbag • Front seat side-impact airbags • Deactivation switch for front passenger's front and side-impact airbags – Ensures front passenger airbags do not inflate when a child seat is fitted to the front passenger's seat

Seating: • Active-safety front seat head restraints • Height-adjustable front and rear seat head restraints • Four lap and diagonal inertia-reel seatbelts • Front and rear body-lock diagonal seatbelt pretensioner system – Tightens the seatbelt during the early stages of a frontal impact • Drivers and front passenger's lap belt pretensioner system • Front seatbelt force limiters – Reduces potential upper body injuries during a frontal impact • Anti-submarining ramps in front seats – Help prevent occupants sliding underneath the lap belt during a collision • ISOFIX child seat restraint system for rear seats incorporating top tether (does not include child seat) – Secures specially designed ISOFIX child safety seats to the vehicle itself, virtually eliminating the dangers that can result from improper installation

Electronic: • Electronic Stability Programme-plus (ESP-plus) – Reduces the possibility of losing control of the vehicle • Anti-lock Braking System (ABS) • Electronic brakeforce distribution • Cornering brake control • Hydraulic brake fade assist – Automatically raises braking pressure to compensate for brake fade under repeated applications of heavy braking • Emergency brake assist – Increases brakeforce applied in emergency braking situations • Straight line stability control • Traction control • Adaptive brake lights – If the driver brakes hard enough to activate the ABS function the brake lights flash on and off at a frequency of four times per second, warning following vehicles that heavy braking is in progress • Tyre pressure monitoring system

Body: • Energy-absorbing steering column • Pedal release system – Reduces potential injury to the driver's legs and feet during a severe frontal impact • Laminated windscreen • Active rollover protection system • Side-impact protection beams • Reinforced passenger safety cell • Deformation zones front and rear • Burst-proof door locks and anti-jam door design

Pedestrian: • Multi-pivot bonnet hinges – Allows the bonnet to move downwards cushioning any impact • Collapsible windscreen wiper system – Reduces the risk of head injury • Low density foam near front bumper crossmember – Reduces lower leg injuries • Plastic lower front bumper stiffener – Reduces knee injuries

Additional feature	SE	Elite	Price (£) exc. VAT	Total (£) inc. VAT
Electronic front seatbelt presenters		●		
Driving Assistance Pack • Following distance indicator • Forward collision alert • Lane departure warning • Traffic sign recognition		○	633.33	760.00
Perimeter Protection Pack • Advanced park assist • Side blind spot alert • Electrically foldable door mirrors	○	○	670.83	805.00

SECURITY

Standard features • Remote control ultrasonic security alarm system • Driver's internal central locking switch • 'Key left in ignition' audible warning • Electronic theft protection for audio equipment • Remote control central deadlocking (doors, boot lid, fuel filler flap) • Electronic engine deadlock immobiliser • Visible Vehicle Identification Number (VIN) plate • Freewheeling door locks • Locking wheel nuts for alloy wheels

HEATING AND VENTILATION

Standard features • Air conditioning with air recirculation • Air blend heater with six-speed fan • Side window demist vents and adjustable face-level air vents • Interior pollen filter • Rear passenger compartment heating outlets

Additional feature	SE	Elite	Price (£) exc. VAT	Total (£) inc. VAT
Dual-zone electronic climate control incorporating air conditioning	○	●	337.50	405.00

● = Standard equipment. ○ = Optional at extra cost.

CASCADA FEATURES/OPTIONS

FACIA, INSTRUMENTS AND CONTROLS

Standard features • Cruise control • Instruments with chrome edging • Rev counter • Multi-function display showing time, date, audio information and outside air temperature • Digital clock with automatic RDS time adjustment • Steering column adjustable for reach and rake • Electronic odometer and trip odometer • Instrument panel light dimmer • Parking brake-on/low brake fluid level and low fuel level warning lights • Service interval monitor • Seatbelt unfastened warning light (front seats only)

<i>Additional features</i>	SE	Elite	Price (£) exc. VAT	Total (£) inc. VAT
Three-spoke leather-covered steering wheel	●			
Three-spoke perforated leather-covered flat-bottomed heated steering wheel		●		
Electric parking brake incorporating hill start assist	●	●		
Leather-covered gear knob (manual models only)	●	●		
Multi-function trip computer (instantaneous fuel consumption, average fuel consumption, range remaining, two trip odometers running concurrently, instantaneous speed, average speed)	●	●		
Winter Pack • Heated leather-covered steering wheel • Heated front seats	○ ¹	●	295.83	355.00
Rear-view camera	○	○	208.33	250.00

INTERIOR LIGHTING

Standard features • Front map reading lights • Ambient lighting in centre console surround

<i>Additional feature</i>	SE	Elite	Price (£) exc. VAT	Total (£) inc. VAT
Ambient lighting in front doors		●		

SEATING AND UPHOLSTERY

Standard features • Sports front seats • Driver's and front passenger's seats with height, reach and recline adjustment • Easy entry front seats • 50/50 split-folding rear seat back • FlexFold rear seats with remote electrical release • Adjustable front centre armrest with storage facility • Storage pockets on front seat backs

<i>Additional features</i>	SE	Elite	Price (£) exc. VAT	Total (£) inc. VAT
Jet Black Pixelstorm cloth seat trim	●			
Leather Pack • Jet Black Siena perforated solar heat-reflective leather seat facings • Electrically heated front seats • Ergonomic AGR* sports front seats with extendable seat cushions, seat tilt adjustment and four-way electrical lumbar adjustment • Heated leather-covered steering wheel • Ambient lighting in front doors • Black Magic centre console and door inserts	○	●	891.67	1070.00
Electrically heated front seats (part of Winter Pack and Leather Pack)	□	●		
Premium Leather Pack² • Brandy Nappa solar heat-reflective leather seat upholstery • Ergonomic AGR* driver's and front passenger's seats with six-way electrical adjustment • Front seat ventilation system • Brandy Nappa leather door trims • Electrically operated easy entry front seats • Piano Black centre console and door inserts		○	2087.50	2505.00
Power Seat Pack • Driver's and front passenger's seats with six-way electrical adjustment • Front seat ventilation system • Electrically operated easy entry front seats		○ ³	341.67	410.00

● = Standard equipment. ○ = Optional at extra cost. □ = Available as part of an option pack. * = AGR (The Campaign for Healthier Backs) is an independent centre of excellence for ergonomics, based in Germany.

¹ = Only available with standard cloth seat trim, also included as part of optional Leather Pack. ² = Optional Malbec acoustic roof is only available in conjunction with Rioja Red exterior colour. ³ = Standard with Premium Leather Pack.

CASCADA FEATURES/OPTIONS

AUDIO, COMMUNICATION AND NAVIGATION

Features	SE	Elite	Price (£) exc. VAT	Total (£) inc. VAT
CD 600 IntelliLink • CD/MP3 CD player • AM/FM stereo radio with 36 station presets • USB connection with iPod control • Audio streaming • IntelliLink • Aux-in socket • RDS with Traffic Programme • Mobile phone system with Bluetooth® (does not include phone) • High resolution 7-inch colour monitor • 20 watts per channel output • 7 premium speakers	●	●		
Navi 650 • Satellite navigation system • Street level mapping for UK and Ireland • Major route mapping for Western Europe • CD/MP3 CD player • Aux-in socket • USB connection with iPod control • AM/FM stereo radio with 36 station presets • RDS with Traffic Programme • High resolution 7-inch colour monitor • 20 watts per channel output • 7 premium speakers • Mobile phone system with Bluetooth® (does not include phone)	○	○	720.83	865.00
Navi 950 IntelliLink • Satellite navigation system • Street level mapping for Europe • CD/MP3 CD player • Mobile phone system with Bluetooth® (does not include phone) • Aux-in socket • USB connection with iPod control • AM/FM stereo radio with 36 station presets • Audio streaming • IntelliLink • RDS with Traffic Programme • High resolution 7-inch colour monitor • 20 watts per channel output • 7 premium speakers	○	○	1008.33	1210.00
OnStar*	●	●		
Digital radio with integrated aerial	●	●		
USB connection with iPod control	●	●		
Steering wheel mounted audio controls	●	●		

● = Standard equipment. ○ = Optional at extra cost.

All OnStar services and Wi-Fi services will cease to be available on 31 December 2020. No trial or paid subscriptions or services, including emergency response services, will be available after that date.

* = Includes 12 months of OnStar services from date of first registration and a 3 month/3 GB Wi-Fi free trial period (whichever comes first) effective from the date the customer accepts the nominated network operator Wi-Fi Ts&Cs. Destination download feature only operates on models fitted with Navi 650 or Navi 950 IntelliLink satellite navigation systems.

ONSTAR – YOUR PERSONAL ON BOARD ASSISTANT

Many car brands talk about innovation as soon as they improve their cup holders but this innovative system, now available on selected models**, is revolutionary: 24/7, 365 days a year, OnStar puts you in touch with a trained advisor, not a machine. With OnStar you have access to a host of innovations, from Vehicle Diagnostics and Smartphone Function to a fully integrated 4G Wi-Fi Hotspot†. In the event of an accident, OnStar even automatically calls for help, for an incomparable feeling of safety.

** = The OnStar Services require activation and are subject to mobile network coverage and availability. Wi-Fi Hotspot service requires account with nominated network operator.

† = 4G is subject to mobile network coverage and availability. Charges apply after the free trial period. The OnStar subscription packages could be different from the services included in the free trial package. Check www.vauxhall.co.uk/onstar for terms and conditions, details of availability, coverage and charges.

SATELLITE NAVIGATION

The optional Navi 650/Navi 950 satellite navigation system offers dynamic route guidance via RDS-TMC (Traffic Message Channel) with directions given audibly and via the 7-inch colour monitor. TMC is a specific application of RDS used for broadcasting real-time traffic information. It alerts the driver to a problem on the planned route and calculates an alternative route to avoid the incident.

In addition to route planning criteria such as 'shortest distance' or 'avoiding toll roads', you can now select an energy-optimised 'green route'. The system will use known factors including your vehicle's weight and engine type, to calculate the most fuel-efficient route.

The Navi 650 system covers all major link roads and streets in towns and cities across mainland Britain and Ireland, plus trunk and main roads for Western Europe. Additional country-specific maps with street level detail are available to download. Navi 950 IntelliLink covers street level mapping across Europe. The CD player plays regular audio CDs and MP3 tracks recorded to CD.

USB CONNECTION

Fitted as standard, the USB connection is located alongside the aux-in within the centre console. It provides iPod control and read-out of iPod functions through the audio system display. Traditional aux-in only allow control of volume through the car's audio system. The USB connection also means that the iPod will charge whilst it is connected.

DIGITAL RADIO

Now widely available in the UK, digital multi-media broadcasts offer the user a variety of advantages over traditional FM, starting with the digital quality sound which is immune to any hiss or crackle. You'll often find a broader range of stations on offer too, many of which are not available on FM, and listening to them couldn't be easier – you simply select the station, by name, from the displayed list, thus removing the need to retune or look for stations when travelling around. Some stations will even display the artists' names and song titles on the car's graphic display, while they're played.

INTELLILINK

The CD 600 and Navi 950 audio system includes the latest IntelliLink technology, designed to support portable Bluetooth® and USB audio devices, so you can hook up your smartphones or tablets to make calls and access your own music, slideshows, podcasts and more.

CASCADA FEATURES/OPTIONS

ADDITIONAL INTERIOR FEATURES

Standard features • 12-volt auxiliary power socket within front and rear centre consoles • Rear passenger central storage facility with twin drinks holders • Chrome-effect internal door handles
 • Lockable glovebox • Storage box on driver's side lower fascia • Front door pockets • Fully carpeted luggage area • Load restraint lashing eyes

<i>Additional features</i>	SE	Elite	Price (£) exc. VAT	Total (£) inc. VAT
Trias centre console and door inserts	●			
Black Magic centre console and door inserts (part of Leather Pack)	□	●		
Piano Black centre console and door inserts (part of premium Leather Pack)		□		
Twin sunvisors incorporating illuminated driver's and front passenger's vanity mirrors with covers		●		
Electro-chromatic anti-dazzle rear-view mirror		●		

MECHANICAL

Standard features • HiPerStrut (High Performance Strut) front suspension • Semi-independent rear suspension with Watt's link and gas-pressure dampers • Power-assisted steering

<i>Additional feature</i>	SE	Elite	Price (£) exc. VAT	Total (£) inc. VAT
FlexRide adaptive chassis control system with continuous damping control	○	○	666.67	800.00

EXTERIOR STYLING AND PROTECTION

Standard features • Dual-layered Black fabric roof • Body-colour door handles • Body-colour door mirrors • Chrome-effect grille • Chrome-effect side window mouldings • Chrome-effect door sill covers
 • Visible stainless steel exhaust tailpipe

<i>Additional features</i>	SE	Elite	Price (£) exc. VAT	Total (£) inc. VAT
Triple-layered acoustic roof (available in either Black or Malbec ⁴)	○	○	258.33	310.00
Two-coat metallic paint	○	○	470.83	565.00
Two-coat premium paint	○	○	545.83	655.00

EXTERIOR LIGHTING

Standard features • Lights-on audible warning • LED centre brake light • Reversing light, rear fog light, hazard warning lights, side repeat indicators • Ellipsoid headlights • Electric headlight beam levelling
 • Daytime running lights • LED rear lights

<i>Additional features</i>	SE	Elite	Price (£) exc. VAT	Total (£) inc. VAT
Premium Forward Lighting Pack • Intelligent Adaptive Forward Lighting (AFL) incorporating dark-style bi-xenon headlights • LED daytime running lights • Automatic headlight levelling • High-pressure headlight washers		○	666.67	800.00
Front fog lights		●		
Automatic lighting control with tunnel detection and digital high beam assist		●		

● = Standard equipment. ○ = Optional at extra cost. □ = Available as part of an option pack.

⁴ = Malbec roof colour not available with Darkmoon Blue and Cosmic Grey exterior colours, SE models with Jet Black Pixelstorm cloth seat trim in conjunction with Summit White exterior colour, and only available on Elite models with optional Premium Leather Pack in conjunction with Rioja Red exterior colour.

CASCADA FEATURES/OPTIONS

EXTERIOR AND CONVENIENCE FEATURES





Standard features • Remote control roof operation • Heated glass rear screen • Electrically operated front and rear windows with safety autoreverse and one-touch facility • Twin electrically adjustable/heated door mirrors (wide angle on driver's side) • Manually foldable door mirrors • Tinted glass • Rear parking distance sensors • Windscreen wipers with variable intermittent facility and flick-wipe • Twin-jet windscreen washer nozzles • Folding key • Dual-tone horn

Additional features	SE	Elite	Price (£) exc. VAT	Total (£) inc. VAT
Windbreak (including deflector)	○	●	220.83	265.00
Sight and Light Pack • Automatic lighting control with tunnel detection • Rain-sensitive windscreen wipers • Electro-chromatic anti-dazzle rear-view mirror • Digital high beam assist		●		
Electrically foldable door mirrors (also available as part of the Perimeter Protection Pack)	○	○	141.67	170.00
Front parking distance sensors (also available as part of the Perimeter Protection Pack)	○	○	329.17	395.00

● = Standard equipment. ○ = Optional at extra cost.

CASCADA FEATURES/OPTIONS

EXTERIOR COLOURS

		Roof colour / roof type	SE	Elite	Price (£) exc. VAT	Total (£) inc. VAT
 <p>Summit White • Solid paint</p>		• Black roof • Dual-layer fabric	●	●		
		• Black roof • Triple-layer acoustic fabric	○	○	258.33	310.00
		• Malbec roof • Triple-layer acoustic fabric • Only available with Leather Pack (£1070)	○		1150.00	1380.00
		• Malbec roof • Triple-layer acoustic fabric		○	258.33	310.00
 <p>Mineral Black • Two-coat metallic paint</p>		• Black roof • Dual-layer fabric	○	○	470.83	565.00
	 <p>Sovereign Silver • Two-coat metallic paint</p>		• Black roof • Triple-layer acoustic fabric (£310)	○	○	729.17
		• Malbec roof • Triple-layer acoustic fabric (£310)				
 <p>Cosmic Grey • Two-coat metallic paint</p>		• Black roof • Dual-layer fabric	○	○	470.83	565.00
		• Black roof • Triple-layer acoustic fabric (£310)	○	○	729.17	875.00

● = Standard equipment. ○ = Optional at extra cost.

The colours reproduced may vary slightly from the actual paint colour. As a result they should be used as a guide only. Your Vauxhall Retailer has a comprehensive display of our paint samples.





Black roof colour.



Malbec roof colour.

CASCADA FEATURES/OPTIONS

EXTERIOR COLOURS

		Roof colour / roof type	SE	Elite	Price (£) exc. VAT	Total (£) inc. VAT
	Darkmoon Blue • Two-coat premium paint	• Black roof • Dual-layer fabric	<input type="radio"/>	<input type="radio"/>	545.83	655.00
		• Black roof • Triple-layer acoustic fabric (£310)	<input type="radio"/>	<input type="radio"/>	804.17	965.00
	Rioja Red • Two-coat premium paint	• Black roof • Dual-layer fabric	<input type="radio"/>	<input type="radio"/>	545.83	655.00
		• Black roof • Triple-layer acoustic fabric (£310)	<input type="radio"/>	<input type="radio"/>	804.17	965.00
		• Malbec roof • Triple-layer acoustic fabric (£310)				

● = Standard equipment. ○ = Optional at extra cost.

The colours reproduced may vary slightly from the actual paint colour. As a result they should be used as a guide only. Your Vauxhall Retailer has a comprehensive display of our paint samples.



Black roof colour.



Malbec roof colour.

CASCADA FEATURES/OPTIONS



WHEELS AND TYRES

	SE	Elite	Price (£) exc. VAT	Total (£) inc. VAT
Emergency tyre inflation kit (in lieu of spare wheel)	●	●		
17-inch emergency steel spare wheel (in lieu of emergency tyre inflation kit)	○	○ ⁵	91.67	110.00
 18-inch 5-twinblade alloy wheels: 235/50 R 18 tyres	●			
 19-inch multi-spoke bi-colour alloy wheels: 235/45 R 19 tyres	○		633.33	760.00
 19-inch multi-spoke bi-colour alloy wheels: 235/45 R 19 tyres		N/C	No-cost option	
 20-inch 5-twinspoke bi-colour alloy wheels: 245/40 R 20 tyres		●		

● = Standard equipment. ○ = Optional at extra cost. N/C = No-cost option.

5 = Not available on 1.6i Turbo (200PS).

TYRE RATING

Tyre size	Fuel efficiency group	Wet grip performance	External noise	
			Measured (dB)	Group
235/50 R 18	E	B	71	
235/45 R 19	E	B	68	
245/40 R 20	E	B	71	

Tyre rating according to EU Regulation 1222/2009

CASCADA SPECIFICATIONS

PETROL ENGINES

	1.4i Turbo (140PS) with Start/Stop	1.6i Turbo (170PS)	1.6i Turbo (200PS) with Start/Stop
Capacity	1364cc	1598cc	1598cc
Maximum power	140PS (103kW) @ 4900-6000rpm	170PS (125kW) @ 4250rpm	200PS (147kW) @ 5500rpm
Maximum torque	200Nm (147 lb.ft.) @ 1850-4900rpm	260Nm (191 lb.ft.) @ 1650-4250rpm	280Nm (206 lb.ft.) @ 1650-3500rpm
Configuration	4 cylinders, 4 valves per cylinder, double overhead camshafts	4 cylinders, 4 valves per cylinder, double overhead camshafts	4 cylinders, 4 valves per cylinder, double overhead camshafts
Fuel/induction system	Water-cooled turbocharger with intercooler. Variable Valve Timing (VVT) Multi-point sequential fuel injection	Water-cooled turbocharger with intercooler. Variable Valve Timing (VVT) Central direct fuel injection	Water-cooled turbocharger with intercooler. Variable Valve Timing (VVT) Central direct fuel injection
Emission compliance	Euro 6	Euro 6	Euro 6
Service interval	20,000 miles or 1 year (whichever occurs sooner)	20,000 miles or 1 year (whichever occurs sooner)	20,000 miles or 1 year (whichever occurs sooner)

DIESEL ENGINES

	2.0CDTi (170PS) Turbo diesel with Start/Stop
Capacity	1956cc
Maximum power	170PS (125kW) @ 4000rpm
Maximum torque	400Nm (295 lb.ft.) @ 1750-2500rpm
Configuration	4 cylinders, 4 valves per cylinder, double overhead camshafts
Fuel/induction system	Variable geometry turbocharger with intercooler. Common rail fuel injection
Emission compliance	Euro 6
Service interval	20,000 miles or 1 year (whichever occurs sooner)

PERFORMANCE, FUEL ECONOMY AND EMISSIONS

	Wheel size (inches)	Performance (manufacturer's figures)		Fuel economy mpg (litres/100km)#			CO ₂ emissions g/km#	Vehicle Excise Duty*		Benefit in kind company car taxation rates – 2018/19 tax year
		Maximum speed (mph)	Acceleration 0-60mph (sec)	Urban driving	Extra-urban driving	Combined figure		First year rate	Standard rate	
Petrol Manual										
1.4i Turbo (140PS) Start/Stop	18/19/20	129	10.2	33.2 (8.5)	52.3 (5.4)	43.5 (6.5)	151	£515	£140	31%
1.6i Turbo (200PS) Start/Stop	19/20	146	8.2	31.0 (9.1)	51.4 (5.5)	40.9 (6.9)	158	£515	£140	32%
Petrol Automatic										
1.6i Turbo (170PS)	19/20	136	9.2	28.0 (10.1)	45.6 (6.2)	37.2 (7.6)	176	£830	£140	36%
Diesel Manual										
2.0CDTi (170PS) Start/Stop	19/20	135	9.6	47.1 (6.0)	67.3 (4.2)	57.6 (4.9)	129	£205	£140	30%

* = Correct at time of publication.

= Fuel consumption information is official government environmental data, tested in accordance with the relevant EU directive. Official EU-regulated test data is provided for comparison purposes and actual performance will depend on driving style, road conditions and other non-technical factors.

CASCADA SPECIFICATIONS

TRANSMISSION

Six-speed manual gearbox

Standard on: 1.4i Turbo (140PS)/1.6i Turbo (200PS)/2.0CDTi (170PS).

Six-speed automatic transmission with ActiveSelect® function

A six-speed automatic transmission is standard on 1.6i Turbo (170PS). On the road, a wide selection of shift patterns is adapted to the style and habits of the driver, anticipating when maximum acceleration or maximum efficiency is required. The electronic control will also adapt to the prevailing road conditions, reducing gear shifting when climbing or descending and using engine braking assistance during down changes.

The ActiveSelect® manual mode allows the gear lever to be used like a sequential manual gearbox – you simply push the lever forward or back to change up or down the gears. The driver also benefits from a 'neutral' gear disengagement at idle, which reduces vibration and contributes to improved fuel consumption.

STEERING

- Power-assisted steering
- Turning circle (kerb-to-kerb):
– 11.8m (38.3ft.)

SUSPENSION

The HiPerStrut (High Performance Strut) front suspension improves grip and allows more power to be applied during cornering. The reduced kingpin angle means less camber loss, which allows the front tyres to retain more of their contact patch with the road during cornering, therefore delaying the onset of understeer. The shorter spindle length significantly reduces torque steer reactions and improves resistance to steering kickback through uneven bends.

Front: Independent. HiPerStrut sports suspension with gas-pressure dampers and coil springs. Anti-roll bar.

Rear: Lightweight compound crank rear axle with one-piece, hollow cast trailing arms. Built-in anti-roll bar. Progressive-rate double conical mini-block springs with Watt's link and gas-pressure dampers.

BRAKES

- Anti-lock Braking System (ABS)
- Electronic brakeforce distribution
- Hydraulic brake fade assist
- Cornering brake control
- Emergency brake assist
- Electric parking brake with Hill start assist

FUEL TANK CAPACITY

All models: 56 litres (12.3 gallons)

WEIGHTS AND TOWING DATA kg

	Gross vehicle weight	Max. towing weights Trailer with brakes (without brakes)
1.4i Turbo (140PS) Start/Stop	2110	1250 (750)
1.6i Turbo (170PS) automatic	2150	1300 (750)
1.6i Turbo (200PS)	2140	1300 (750)
2.0CDTi (170PS) Start/Stop	2225	1300 (750)

Gross vehicle weight is the total permissible weight of the vehicle including passengers and their luggage. The maximum towing weights are based on the ability of the car, with two occupants of 75kg each, to restart on a 12% gradient, which is approximately 1 in 8.3, at sea level. At altitudes above 1500 metres, the engine output may drop with a corresponding reduction in towing capability. Any extra weight, such as luggage or additional passengers, should be deducted from the maximum towing weight. With a trailer fully loaded, maximum noseweight should not exceed 75kg. Always fit Vauxhall towing attachments and accessories available from your Vauxhall Retailer. They are designed specifically for Vauxhall models and carry a 12-month guarantee.

CASCADA SPECIFICATIONS

EXTERIOR DIMENSIONS millimetres (inches)

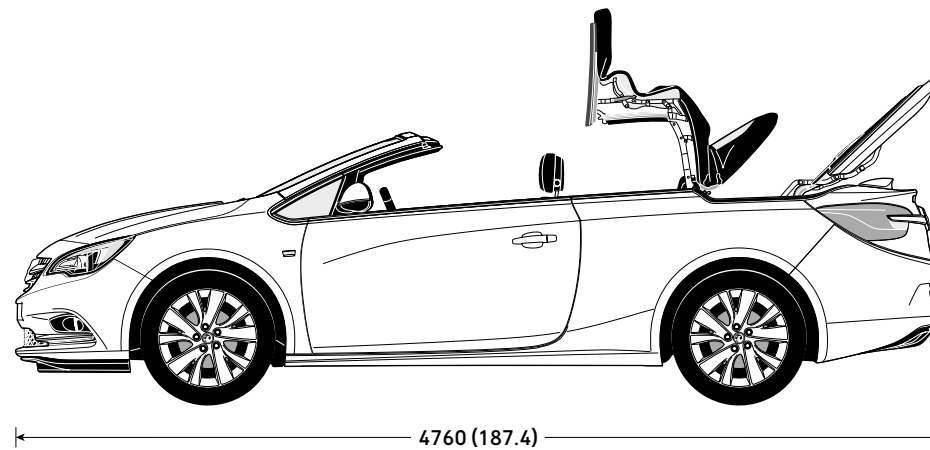
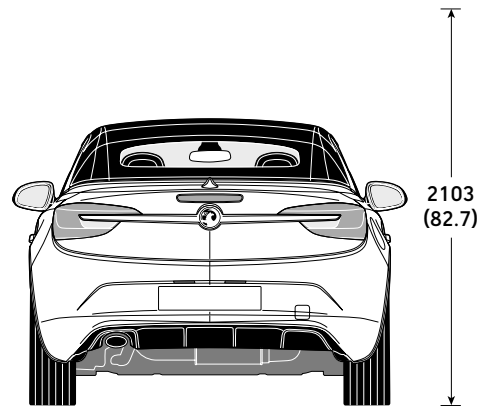
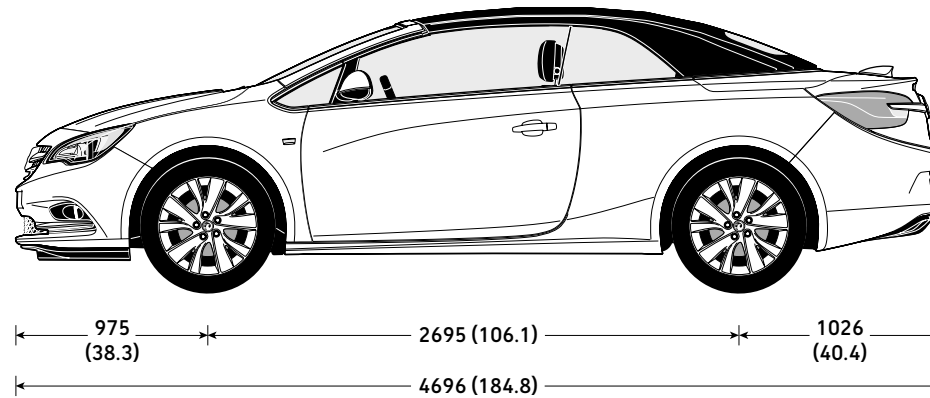
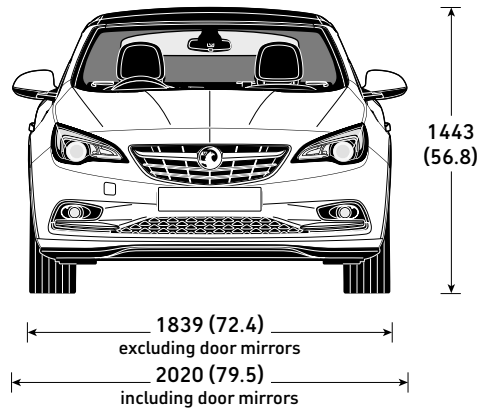

LUGGAGE CAPACITIES*

	litres (cu.ft.)
Rear seats up (roof closed)	380 (13.4)
Rear seats up (roof open)	280 (9.8)
Rear seats down (roof closed)	750 (26.4)
Rear seats down (roof open)	650 (22.9)

* = Measured using the ECIE method.

CASCADA ACCESSORIES

INFOTAINMENT

Sat Nav updates¹

Please consult your Retailer for latest map updates or visit www.vauxhall.co.uk/accessories.

1 = For use with optional factory-fit satellite navigation systems.

CHILD SEATS²

BABY-SAFE ³ – 0-13kg/birth to 15 months	£132.00
– ISOFIX base	£227.00
DUO ISOFIX ³ – 9-18kg/9 months to 4 years with top tether kit	£347.00
KID ³ –15-36kg or 4 to 12 years	£157.00

2 = Restrictions apply to the use of child seats, please consult your Vauxhall Retailer or request a copy of the Child seats brochure.

3 = Without transponder.

INTERIOR

Console organiser	£16.00
– Note pad	£16.00
– Pen	£16.00
Aux-in cable	£6.00

SAFETY

Safety Pack – first aid kit, warning triangle, hi-visibility vest, Vauxhall bag	£35.00
First aid kit	£15.00
Warning triangle	£17.00
Hi-visibility vest	£9.00
Fire extinguisher – 2kg	£37.00
Temporary tyre inflation kit	£120.00
Tyre sealant	£68.00

SECURITY

Locking wheel bolts – set of four	£39.00
-----------------------------------	--------

FLEXCONNECT RANGE

FlexConnect bracket	£20.00
FlexConnect hook	£28.00
FlexConnect coat hanger	£58.00
FlexConnect folding table	£68.00
FlexConnect iPad Mini cradle	£98.00
FlexConnect iPad (1-4) cradle	£106.00
FlexConnect iPad Air cradle	£106.00
FlexConnect Samsung Galaxy cradle	£96.00

PRACTICAL

Spare bulb kit ⁴	£26.00
Premium spare bulb kit ⁴	£50.00
Wind deflector	
– front seat	£334.00
– rear seat	£90.00
Smoker pack	£34.00

4 = Excludes xenon headlight bulb for models with Adaptive Forward Lighting (AFL)

PROTECTION

Economy floor mats – set of four	£34.00
Rubber floor mats – set of four	£43.00
Velour floor mats – set of four (black or brandy)	£71.00
Car cover	£425.00
VX protect Cascada pack	Contact Retailer
Door sill plates	£67.00
Tailored load compartment net	£26.00
Luggage net	£21.00

TOURING

Detachable tow bar	
– 12N electrics	£685.00
– 12S electrics	£833.00
– 13-pin electrics	£735.00

STYLING

VX-Line pedal covers	
– manual	£113.00
– automatic	£135.00

ALLOY WHEELS (set of four with centre caps)⁵

19-inch 5-spoke	from £1137.00
20-inch 5-twin-spoke	from £1065.00

Other designs available

5 = Different tyres and locking wheel bolts/nuts may be required at extra cost. Price excludes new tyres and locking wheel bolts/nuts, includes static wheel balancing.

Please note:

Prices shown are a fully fitted and painted, where applicable and include VAT. Please check with your local Vauxhall Retailer for details. It is advisable to ensure your insurance policy is adequate to cover additional fitted accessories. Prices correct at time of publication.

CASCADA COMPANY CAR DRIVER/FLEET INFORMATION

FLEET TOOLBOX

Discover the facts in our online Toolbox for both Company Car Drivers and Fleet Decision Makers. The Fleet Toolbox has a host of useful calculators, comparators, interactive listings and information. Visit the Fleet Toolbox by going to www.vauxhall-toolbox.co.uk



ROADTRIP APP

The Vauxhall RoadTrip App is a free app that calculates and logs your mileage expenses for any UK business trips and generates reports to help you complete your mileage claims. Available for both iPhone and Android, visit www.vauxhall-toolbox.co.uk or visit the iPhone or Android stores and search for Vauxhall RoadTrip to download it to your smartphone or tablet.



BENEFIT IN KIND COMPANY CAR TAXATION*

The car benefit charge will be the car's list price (including VAT, options and accessories fitted, delivery to Retailer and number plates, but excluding Vehicle Excise Duty and new vehicle first registration fee) multiplied by the percentage charge for the CO₂ emissions band in which the car falls (see table opposite). Multiply this figure by your personal income tax rate (20%** for Basic Rate, 40%** for Higher Rate) to calculate your annual benefit in kind tax liability.

Example:

Cascada Elite 2.0CDTi (170PS) Start/Stop (CO ₂ emissions 129g/km)	
On-the-road RRP	£33195.00
Deduct: Vehicle Excise Duty	(£205.00)
New vehicle first registration fee	(£55.00)
Effective list price	£32935.00
Add: Optional two-coat metallic paint	£565.00
List price for tax purposes (P11D value)	£33500.00
Car benefit charge	
2018-19 tax year (30%)	£10050.00
Benefit in kind tax liability (2018-19 tax year)	
Basic Rate (20%) tax payer	£2010.00
Higher Rate (40%) tax payer	£4020.00

* = Please note this Price Guide provides taxation information as a guide only. Vauxhall does not provide taxation guidance. Drivers should always take professional advice on their own tax position. ** = Excludes residents of Scotland.

BIK FOR SCOTTISH RESIDENTS

Effective 6 April 2018 the Scottish Government have introduced their own BIK taxation structure. This only applies to Company Car Drivers that are Scottish taxpayers. HMRC will determine whether or not an individual is a Scottish taxpayer based on where their main place of residence is.

The BIK rates for Scotland are:

- Over £11,850-£13,850 Starter Rate 19%
- Over £13,850-£24,000 Basic Rate 20%
- Over £24,000-£43,430 Intermediate Rate 21%
- Over £43,430-£150,000 Higher Rate 41%
- Above £150,000 Top Rate 46%

CO ₂ emissions in grams per kilometre	Percentage of car's price to be taxed	
	Non-Diesel† 2018-19 tax year	Diesel†† 2018-19 tax year
Up to 50	13	17
51-75	16	20
76-94	19	23
95-99	20	24
100-104	21	25
105-109	22	26
110-114	23	27
115-119	24	28
120-124	25	29
125-129	26	30
130-134	27	31
135-139	28	32
140-144	29	33
145-149	30	34
150-154	31	35
155-159	32	36
160-164	33	37
165-169	34	37
170-174	35	37
175-179	36	37
180 and above	37	37

† = Also applies to diesel vehicles that meet the Real Driving Emissions Step 2 (RDE2). †† = Applies to vehicles that do not meet the Real Driving Emissions Step 2 (RDE2).

To calculate your own personal liability a car tax calculator is available at: <https://www.vauxhallfleet.co.uk/toolbox>

CONTACT VAUXHALL FLEET

Please contact one of our dedicated sales teams who will be happy to help with your particular enquiry.

Company Car Drivers

Call: 0345 111 2020

Email: company-car@vauxhallinfo.co.uk

Telephone lines are open

– Monday to Friday 8.00am-9.00pm

– Saturday and Sunday 9.00am-6.00pm

Fleet Decision Makers

Depending on the size of your fleet of vehicles, we have a dedicated team to handle your enquiries. The lines are open Monday to Friday excluding Bank Holidays.

1-24 vehicles

Call: 0845 076 2254 (8.30am-5.00pm)

Email: b2bsales@vauxhall.co.uk

25+ vehicles

Call: 0330 587 8222 (8.30am-5.00pm)

Email: vauxhallfleet@vauxhall.co.uk

Special Vehicles (Police, Fire and Ambulance)

Call: 01582 409999 (8.30am-5.00pm)

Email: vauxhallspecialvehicles@vauxhall.co.uk

CASCADA ADDITIONAL INFORMATION

ON-THE-ROAD PRICES

To eliminate uncertainty about hidden costs when buying a new car, Vauxhall publishes on-the-road recommended retail prices (RRP) and these are shown in the pricing tables within this price guide. These prices include VAT, number plates and delivery to Retailer of £700.00 (including £116.67 VAT), 12 months' Government Vehicle Excise Duty (see opposite for details) and the DVLA new vehicle first registration fee of £55.00*.

Please note: The on-the-road recommended retail price (RRP) does not include fuel supplied by the Retailer, motor insurance or any other goods or services supplied by agreement between the Retailer and the customer.

PRICE PROTECTION

Order a new Vauxhall for build in the current model year (as confirmed by your Retailer) for delivery no more than three months in advance and the price you are quoted is the price you pay. This is irrespective of any subsequent price rises between placing your order and delivery of your new car, but you must take delivery as soon as the car is available. Vauxhall Motors Limited is not liable for price adjustments caused by Government changes in the rate of VAT (currently 20%), Vehicle Excise Duty, DVLA new vehicle first registration fee or by any other applicable legislation or regulations.

VAUXHALL FINANCE LEASING

Vauxhall Finance Leasing is a trading style of Vauxhall Finance plc. Working with the Vauxhall Retailer network we provide competitive car and van leasing solutions for business users and private individuals. We combine the support of a national contract with the convenience of a local contact. For further information, please contact your local Vauxhall Retailer or visit www.vauxhall.co.uk/leasing

IN THE EVENT OF AN ACCIDENT...

Vauxhall Accident Management helps keep you mobile following an accident. Benefits include vehicle recovery, Vauxhall-approved repairs and contacting your insurer. For more details, visit vauxhall.co.uk/AccidentManagement

VEHICLE EXCISE DUTY

The amount of Vehicle Excise Duty (road fund licence) payable on new cars varies depending on the level of carbon dioxide (CO₂) emissions produced by the vehicle. CO₂ emissions are measured in grammes (g) per kilometre (km) travelled and divided into 13 charging bands shown in the table below.

A 'first year rate' of Vehicle Excise Duty is payable on all new cars and in subsequent years the amount payable reverts to the 'standard rate'. From 1 April 2017 the breakpoints for each of these bands have been revised. Also, for vehicles with a list price over £40,000, including factory-fitted options, an additional £310 is payable for the first five years of standard rate payments.

VEHICLE EXCISE DUTY*

	CO ₂ emissions	First year rate		Standard rate
		Non-diesel**	Diesel†	
Band A	0g/km	£0.00	£0.00	£0.00
Band B	1 – 50g/km	£10.00	£25.00	£140.00
Band C	51 – 75g/km	£25.00	£105.00	£140.00
Band D	76 – 90g/km	£105.00	£125.00	£140.00
Band E	91 – 100g/km	£125.00	£145.00	£140.00
Band F	101 – 110g/km	£145.00	£165.00	£140.00
Band G	111 – 130g/km	£165.00	£205.00	£140.00
Band H	131 – 150g/km	£205.00	£515.00	£140.00
Band I	151 – 170g/km	£515.00	£830.00	£140.00
Band J	171 – 190g/km	£830.00	£1,240.00	£140.00
Band K	191 – 225g/km	£1,240.00	£1,760.00	£140.00
Band L	226 – 255g/km	£1,760.00	£2,070.00	£140.00
Band M	over 255g/km	£2,070.00	£2,070.00	£140.00

* = Correct at time of issue. ** = Also applies to diesel vehicles that meet the Real Driving Emissions Step 2 (RDE2).

† = Applies to vehicles that do not meet the Real Driving Emissions Step 2 (RDE2).

TRUST VAUXHALL

CUSTOMER CARE COMMITMENT

For added peace of mind, Vauxhall has an innovative Customer Care Commitment that offers the following:

- Three-year vehicle warranty consisting of a one-year/unlimited mileage manufacturer's warranty and a second and third year manufacturer's warranty with a 60,000 miles limitation
- Vauxhall Assistance for 12 months from first registration
- Six years' body panel anti-perforation warranty

Please note: Warranty is only available on vehicles sourced from Vauxhall Motors Limited. Terms and conditions apply – please see your Vauxhall Retailer for details.

VAUXHALL ASSISTANCE

Vauxhall Assistance is provided automatically with every new Vauxhall for 12 months from first registration and covers everything from accident assistance, roadside recovery and 'at home' service to flat tyres. With Vauxhall Assistance help is literally just a free* phone call away, 24 hours a day, 365 days a year!

* = Mobile phone users will be charged at their standard tariff.

PROTECTING THE ENVIRONMENT

Vauxhall's commitment to the environment is demonstrated by our products' many environmental awards. For even more information on Vauxhall's efforts to achieve an environmentally sustainable future, and how to dispose of your end-of-life vehicle, see www.vauxhall.co.uk/recycling

VAUXHALL SERVICE PLAN

- Fixed monthly payments for the plan duration
- Easy to budget and interest-free
- Genuine parts fitted by Vauxhall-trained technicians

Plus on Gold plans:

- Valet and courtesy car
- Full AA cover
- Engine flush and fuel treatments
- Litre of oil for top ups between services

Full details can be obtained from your local participating Vauxhall Retailer.

VAUXHALL INSURANCE WITH ADDED REASSURANCE

Comprehensive cover – Summary of benefits**

- Competitive premiums
- Repairs by a Vauxhall-trained technician
- Genuine Vauxhall parts, guaranteed for three years when we repair your car within our Approved Repairer Network
- Free courtesy car as standard when using an Approved Repairer†
- 24 hour claims helpline
- Personal Accident benefit
- Cover for audio equipment
- Windscreen cover

Call for a quote on 0844 463 2670††

** = The benefits listed above are for comprehensive cover only. For details of Third Party, Fire and Theft cover, please call our sales team.
† = Should your car need repairing following an accident we provide a courtesy car (subject to availability) for the duration of the repair. Only genuine Vauxhall parts are used. Terms and conditions apply.
†† = Calls may be recorded. Vauxhall Insurance is underwritten by Ageas Insurance Limited.

FOR MORE PRODUCT INFORMATION

For a brochure on any Vauxhall model (up to a maximum of three per caller) or location of your nearest Vauxhall Retailer please call **0345 600 1500**. Alternatively, details can be found on our website at www.vauxhall.co.uk

JOIN US ONLINE:



Privacy Policy – For full details please visit: vauxhall.co.uk/privacy

OnStar privacy details are available at vauxhall.co.uk/onstar

The invoice price, including delivery to Retailer, factory-fitted options, accessories fitted by the Retailer and number plates, is subject to VAT. Some feature descriptions in this guide may refer to, and some illustrations may show, optional equipment not included in the standard delivery. The information contained in this guide was accurate at the time of publication. We reserve the right to make changes in design and equipment. Please note that Vauxhall Retailers are not the agents of Vauxhall Motors Limited and are not authorised to bind Vauxhall Motors Limited by any specific or implied undertaking or representation. It is advisable to ensure that your motor insurance policy provides adequate cover for additional fitted options and accessories. The colours in this guide are only approximate actual colours. Illustrated optional equipment is available at extra charge. Availability, technical features and equipment provided on our vehicles can vary by model. For precise information on the equipment provided on our vehicles, please contact your local Vauxhall Retailer.

VAUXHALL

vauxhall.co.uk

©2018 Vauxhall Motors Limited

Published 1 April 2018 (Amended 18 July 2018) Vauxhall Motors Limited

CASCADA

PRICE/SPECIFICATION GUIDE

19 December 2017

Pre-current Model Year



VAUXHALL

CASCADA RANGE HIGHLIGHTS AND PRICES

ELITE £31,335-£34,105

Features over SE

- 20-inch 5-twinspoke bi-colour alloy wheels
- Dual-zone electronic climate control
- Perforated solar heat-reflective leather seat facings
- Heated front seats
- Ergonomic sports front seats with extendable seat cushions
- Front seats with tilt and four-way electrical lumbar adjustment
- Three-spoke perforated leather-covered flat-bottomed heated steering wheel
- Rain-sensitive windscreen wipers
- Automatic lighting control with tunnel detection and digital high beam assist
- Electro-chromatic anti-dazzle rear-view mirror
- Front fog lights
- Electronic front seatbelt presenters
- Windbreak
- Ambient lighting in doors
- Driver's and front passenger's sunvisors with illuminated vanity mirrors

Model	Price (£)	VAT (£)	Total (£)	On-the-road RRP (£)	CO ₂ (g/km)
2-door convertible					
ELITE VAUXHALL OnStar					
1.4i Turbo (140PS) S/S	25066.67	5013.33	30080.00	31335.00	151
1.6i Turbo (170PS) auto	27125.00	5425.00	32550.00	34105.00	176
1.6i Turbo (200PS) S/S	26400.00	5280.00	31680.00	32935.00	158
<i>Diesel</i>					
2.0CDTi (170PS) S/S BlueInjection*	26862.50	5372.50	32235.00	33150.00	129

Please note: On-the-road recommended retail prices (RRP) include number plates and delivery to Retailer of £700.00 (inc. £116.67 VAT), 12 months' Vehicle Excise Duty and new vehicle first registration fee of £55.00. Excludes fuel and insurance.

* = This engine features new BlueInjection technology. For more information, visit www.vauxhall.co.uk/blueinjection

CASCADA FEATURES/OPTIONS

SAFETY

Standard features

Airbags: • Driver's airbag • Front passenger's airbag • Front seat side-impact airbags • Deactivation switch for front passenger's front and side-impact airbags – Ensures front passenger airbags do not inflate when a child seat is fitted to the front passenger's seat

Seating: • Active-safety front seat head restraints • Height-adjustable front and rear seat head restraints • Four lap and diagonal inertia-reel seatbelts • Front and rear body-lock diagonal seatbelt pretensioner system – Tightens the seatbelt during the early stages of a frontal impact • Drivers and front passenger's lap belt pretensioner system • Front seatbelt force limiters – Reduces potential upper body injuries during a frontal impact • Anti-submarining ramps in front seats – Help prevent occupants sliding underneath the lap belt during a collision • ISOFIX child seat restraint system for rear seats incorporating top tether (does not include child seat) – Secures specially designed ISOFIX child safety seats to the vehicle itself, virtually eliminating the dangers that can result from improper installation

Electronic: • Electronic Stability Programme-plus (ESP-plus) – Reduces the possibility of losing control of the vehicle • Anti-lock Braking System (ABS) • Electronic brakeforce distribution • Cornering brake control • Hydraulic brake fade assist – Automatically raises braking pressure to compensate for brake fade under repeated applications of heavy braking • Emergency brake assist – Increases brakeforce applied in emergency braking situations • Straight line stability control • Traction control • Adaptive brake lights – If the driver brakes hard enough to activate the ABS function the brake lights flash on and off at a frequency of four times per second, warning following vehicles that heavy braking is in progress • Tyre pressure monitoring system

Body: • Energy-absorbing steering column • Pedal release system – Reduces potential injury to the driver's legs and feet during a severe frontal impact • Laminated windscreen • Active rollover protection system • Side-impact protection beams • Reinforced passenger safety cell • Deformation zones front and rear • Burst-proof door locks and anti-jam door design

Pedestrian: • Multi-pivot bonnet hinges – Allows the bonnet to move downwards cushioning any impact • Collapsible windscreen wiper system – Reduces the risk of head injury • Low density foam near front bumper crossmember – Reduces lower leg injuries • Plastic lower front bumper stiffener – Reduces knee injuries

<i>Additional feature</i>	SE	Elite	Price (£) exc. VAT	Total (£) inc. VAT
Electronic front seatbelt presenters		●		
Driving Assistance Pack • Following distance indicator • Forward collision alert • Lane departure warning • Traffic sign recognition		○	633.33	760.00
Perimeter Protection Pack • Advanced park assist • Side blind spot alert • Electrically foldable door mirrors	○	○	670.83	805.00

SECURITY

Standard features • Remote control ultrasonic security alarm system • Driver's internal central locking switch • 'Key left in ignition' audible warning • Electronic theft protection for audio equipment • Remote control central deadlocking (doors, boot lid, fuel filler flap) • Electronic engine deadlock immobiliser • Visible Vehicle Identification Number (VIN) plate • Freewheeling door locks • Locking wheel nuts for alloy wheels

HEATING AND VENTILATION

Standard features • Air conditioning with air recirculation • Air blend heater with six-speed fan • Side window demist vents and adjustable face-level air vents • Interior pollen filter • Rear passenger compartment heating outlets

<i>Additional feature</i>	SE	Elite	Price (£) exc. VAT	Total (£) inc. VAT
Dual-zone electronic climate control incorporating air conditioning	○	●	337.50	405.00

● = Standard equipment. ○ = Optional at extra cost.

CASCADA FEATURES/OPTIONS

FACIA, INSTRUMENTS AND CONTROLS

Standard features • Cruise control • Instruments with chrome edging • Rev counter • Multi-function display showing time, date, audio information and outside air temperature • Digital clock with automatic RDS time adjustment • Steering column adjustable for reach and rake • Electronic odometer and trip odometer • Instrument panel light dimmer • Parking brake-on/low brake fluid level and low fuel level warning lights • Service interval monitor • Seatbelt unfastened warning light (front seats only)

<i>Additional features</i>	SE	Elite	Price (£) exc. VAT	Total (£) inc. VAT
Three-spoke leather-covered steering wheel	●			
Three-spoke perforated leather-covered flat-bottomed heated steering wheel		●		
Electric parking brake incorporating hill start assist	●	●		
Leather-covered gear knob (manual models only)	●	●		
Multi-function trip computer (instantaneous fuel consumption, average fuel consumption, range remaining, two trip odometers running concurrently, instantaneous speed, average speed)	●	●		
Winter Pack • Heated leather-covered steering wheel • Heated front seats	○ ¹	●	295.83	355.00
Rear-view camera	○	○	208.33	250.00

INTERIOR LIGHTING

Standard features • Front map reading lights • Ambient lighting in centre console surround

<i>Additional feature</i>	SE	Elite	Price (£) exc. VAT	Total (£) inc. VAT
Ambient lighting in front doors		●		

SEATING AND UPHOLSTERY

Standard features • Sports front seats • Driver's and front passenger's seats with height, reach and recline adjustment • Easy entry front seats • 50/50 split-folding rear seat back • FlexFold rear seats with remote electrical release • Adjustable front centre armrest with storage facility • Storage pockets on front seat backs

<i>Additional features</i>	SE	Elite	Price (£) exc. VAT	Total (£) inc. VAT
Jet Black Pixelstorm cloth seat trim	●			
Leather Pack • Jet Black Siena perforated solar heat-reflective leather seat facings • Electrically heated front seats • Ergonomic AGR* sports front seats with extendable seat cushions, seat tilt adjustment and four-way electrical lumbar adjustment • Heated leather-covered steering wheel • Ambient lighting in front doors • Black Magic centre console and door inserts	○	●	891.67	1070.00
Electrically heated front seats (part of Winter Pack and Leather Pack)	□	●		
Premium Leather Pack ² • Brandy Nappa solar heat-reflective leather seat upholstery • Ergonomic AGR* driver's and front passenger's seats with six-way electrical adjustment • Front seat ventilation system • Brandy Nappa leather door trims • Electrically operated easy entry front seats • Piano Black centre console and door inserts		○	2087.50	2505.00
Power Seat Pack • Driver's and front passenger's seats with six-way electrical adjustment • Front seat ventilation system • Electrically operated easy entry front seats		○ ³	341.67	410.00

● = Standard equipment. ○ = Optional at extra cost. □ = Available as part of an option pack. * = AGR (The Campaign for Healthier Backs) is an independent centre of excellence for ergonomics, based in Germany.

¹ = Only available with standard cloth seat trim, also included as part of optional Leather Pack. ² = Optional Malbec acoustic roof is only available in conjunction with Rioja Red exterior colour. ³ = Standard with Premium Leather Pack.

CASCADA FEATURES/OPTIONS

AUDIO, COMMUNICATION AND NAVIGATION

Features	SE	Elite	Price (£) exc. VAT	Total (£) inc. VAT
CD 600 IntelliLink • CD/MP3 CD player • AM/FM stereo radio with 36 station presets • USB connection with iPod control • Audio streaming • IntelliLink • Aux-in socket • RDS with Traffic Programme • Mobile phone system with Bluetooth® (does not include phone) • High resolution 7-inch colour monitor • 20 watts per channel output • 7 premium speakers	●	●		
Navi 650 • Satellite navigation system • Street level mapping for UK and Ireland • Major route mapping for Western Europe • CD/MP3 CD player • Aux-in socket • USB connection with iPod control • AM/FM stereo radio with 36 station presets • RDS with Traffic Programme • High resolution 7-inch colour monitor • 20 watts per channel output • 7 premium speakers • Mobile phone system with Bluetooth® (does not include phone)	○	○	720.83	865.00
Navi 950 IntelliLink • Satellite navigation system • Street level mapping for Europe • CD/MP3 CD player • Mobile phone system with Bluetooth® (does not include phone) • Aux-in socket • USB connection with iPod control • AM/FM stereo radio with 36 station presets • Audio streaming • IntelliLink • RDS with Traffic Programme • High resolution 7-inch colour monitor • 20 watts per channel output • 7 premium speakers	○	○	1008.33	1210.00
Vauxhall OnStar*	●	●		
Digital radio with integrated aerial	●	●		
USB connection with iPod control	●	●		
Steering wheel mounted audio controls	●	●		

● = Standard equipment. ○ = Optional at extra cost.

* = Includes 12 months of OnStar services from date of first registration and a 3 month/3 GB Wi-Fi free trial period (whichever comes first) effective from the date the customer accepts the nominated network operator Wi-Fi Ts&Cs. Destination download feature only operates on models fitted with Navi 650 or Navi 950 IntelliLink satellite navigation systems.

VAUXHALL ONSTAR – YOUR PERSONAL ON BOARD ASSISTANT

Many car brands talk about innovation as soon as they improve their cup holders but this innovative system, now available on selected models**, is revolutionary: 24/7, 365 days a year, Vauxhall OnStar puts you in touch with a trained advisor, not a machine. With OnStar you have access to a host of innovations, from Vehicle Diagnostics and Smartphone Function to a fully integrated 4G Wi-Fi Hotspot†. In the event of an accident, Vauxhall OnStar even automatically calls for help, for an incomparable feeling of safety.

** = The OnStar Services require activation and are subject to mobile network coverage and availability. Wi-Fi Hotspot service requires account with nominated network operator.

† = 4G is subject to mobile network coverage and availability. Charges apply after the free trial period. The OnStar subscription packages could be different from the services included in the free trial package. Check www.vauxhall.co.uk/onstar for terms and conditions, details of availability, coverage and charges.

SATELLITE NAVIGATION

The optional Navi 650/Navi 950 satellite navigation system offers dynamic route guidance via RDS-TMC (Traffic Message Channel) with directions given audibly and via the 7-inch colour monitor. TMC is a specific application of RDS used for broadcasting real-time traffic information. It alerts the driver to a problem on the planned route and calculates an alternative route to avoid the incident.

In addition to route planning criteria such as 'shortest distance' or 'avoiding toll roads', you can now select an energy-optimised 'green route'. The system will use known factors including your vehicle's weight and engine type, to calculate the most fuel-efficient route.

The Navi 650 system covers all major link roads and streets in towns and cities across mainland Britain and Ireland, plus trunk and main roads for Western Europe. Additional country-specific maps with street level detail are available to download. Navi 950 IntelliLink covers street level mapping across Europe. The CD player plays regular audio CDs and MP3 tracks recorded to CD.

USB CONNECTION

Fitted as standard, the USB connection is located alongside the aux-in within the centre console. It provides iPod control and read-out of iPod functions through the audio system display. Traditional aux-in only allow control of volume through the car's audio system. The USB connection also means that the iPod will charge whilst it is connected.

DIGITAL RADIO

Now widely available in the UK, digital multi-media broadcasts offer the user a variety of advantages over traditional FM, starting with the digital quality sound which is immune to any hiss or crackle. You'll often find a broader range of stations on offer too, many of which are not available on FM, and listening to them couldn't be easier – you simply select the station, by name, from the displayed list, thus removing the need to retune or look for stations when travelling around. Some stations will even display the artists' names and song titles on the car's graphic display, while they're played.

INTELLILINK

The CD 600 and Navi 950 audio system includes the latest IntelliLink technology, designed to support portable Bluetooth® and USB audio devices, so you can hook up your smartphones or tablets to make calls and access your own music, slideshows, podcasts and more.

CASCADA FEATURES/OPTIONS

ADDITIONAL INTERIOR FEATURES

Standard features • 12-volt auxiliary power socket within front and rear centre consoles • Rear passenger central storage facility with twin drinks holders • Chrome-effect internal door handles
• Lockable glovebox • Storage box on driver's side lower fascia • Front door pockets • Fully carpeted luggage area • Load restraint lashing eyes

<i>Additional features</i>	SE	Elite	Price (£) exc. VAT	Total (£) inc. VAT
Trias centre console and door inserts	●			
Black Magic centre console and door inserts (part of Leather Pack)	□	●		
Piano Black centre console and door inserts (part of premium Leather Pack)		□		
Twin sunvisors incorporating illuminated driver's and front passenger's vanity mirrors with covers		●		
Electro-chromatic anti-dazzle rear-view mirror (part of Sight and Light Pack)	□	●		

MECHANICAL

Standard features • HiPerStrut (High Performance Strut) front suspension • Semi-independent rear suspension with Watt's link and gas-pressure dampers • Power-assisted steering

<i>Additional feature</i>	SE	Elite	Price (£) exc. VAT	Total (£) inc. VAT
FlexRide adaptive chassis control system with continuous damping control	○	○	666.67	800.00

EXTERIOR STYLING AND PROTECTION

Standard features • Dual-layered Black fabric roof • Body-colour door handles • Body-colour door mirrors • Chrome-effect grille • Chrome-effect side window mouldings • Chrome-effect door sill covers
• Visible stainless steel exhaust tailpipe

<i>Additional features</i>	SE	Elite	Price (£) exc. VAT	Total (£) inc. VAT
Triple-layered acoustic roof (available in either Black or Malbec ⁴)	○	○	258.33	310.00
Two-coat metallic paint	○	○	470.83	565.00
Two-coat premium paint	○	○	545.83	655.00

EXTERIOR LIGHTING

Standard features • Lights-on audible warning • LED centre brake light • Reversing light, rear fog light, hazard warning lights, side repeat indicators • Ellipsoid headlights • Electric headlight beam levelling
• Daytime running lights • LED rear lights

<i>Additional features</i>	SE	Elite	Price (£) exc. VAT	Total (£) inc. VAT
Premium Forward Lighting Pack • Intelligent Adaptive Forward Lighting (AFL) incorporating dark-style bi-xenon headlights • LED daytime running lights • Automatic headlight levelling • High-pressure headlight washers	○ ⁵	○	666.67	800.00
Front fog lights		●		
Automatic lighting control with tunnel detection and digital high beam assist (part of Sight and Light Pack)	□	●		

● = Standard equipment. ○ = Optional at extra cost. □ = Available as part of an option pack.

⁴ = Malbec roof colour not available with Darkmoon Blue and Cosmic Grey exterior colours, SE models with Jet Black Pixelstorm cloth seat trim in conjunction with Summit White exterior colour, and only available on Elite models with optional Premium Leather Pack in conjunction with Rioja Red exterior colour. ⁵ = Sight and Light Pack required.

CASCADA FEATURES/OPTIONS

EXTERIOR AND CONVENIENCE FEATURES



Standard features • Remote control roof operation • Heated glass rear screen • Electrically operated front and rear windows with safety autoreverse and one-touch facility • Twin electrically adjustable/heated door mirrors (wide angle on driver's side) • Manually foldable door mirrors • Tinted glass • Rear parking distance sensors • Windscreen wipers with variable intermittent facility and flick-wipe • Twin-jet windscreen washer nozzles • Folding key • Dual-tone horn

Additional features	SE	Elite	Price (£) exc. VAT	Total (£) inc. VAT
Windbreak (including deflector)	○	●	220.83	265.00
Sight and Light Pack • Automatic lighting control with tunnel detection • Rain-sensitive windscreen wipers • Electro-chromatic anti-dazzle rear-view mirror • Digital high beam assist	○	●	200.00	240.00
Electrically foldable door mirrors (also available as part of the Perimeter Protection Pack)	○	○	141.67	170.00
Front parking distance sensors (also available as part of the Perimeter Protection Pack)	○	○	329.17	395.00

● = Standard equipment. ○ = Optional at extra cost.

CASCADA FEATURES/OPTIONS

EXTERIOR COLOURS

		Roof colour / roof type	SE	Elite	Price (£) exc. VAT	Total (£) inc. VAT
 <p>Summit White • Solid paint</p>		• Black roof • Dual-layer fabric	●	●		
		• Black roof • Triple-layer acoustic fabric	○	○	258.33	310.00
		• Malbec roof • Triple-layer acoustic fabric • Only available with Leather Pack (£1070)	○		1150.00	1380.00
		• Malbec roof • Triple-layer acoustic fabric		○	258.33	310.00
 <p>Mineral Black • Two-coat metallic paint</p>		• Black roof • Dual-layer fabric	○	○	470.83	565.00
	 <p>Sovereign Silver • Two-coat metallic paint</p>		• Black roof • Triple-layer acoustic fabric (£310)	○	○	729.17
		• Malbec roof • Triple-layer acoustic fabric (£310)				
 <p>Cosmic Grey • Two-coat metallic paint</p>		• Black roof • Dual-layer fabric	○	○	470.83	565.00
		• Black roof • Triple-layer acoustic fabric (£310)	○	○	729.17	875.00

● = Standard equipment. ○ = Optional at extra cost.

The colours reproduced may vary slightly from the actual paint colour. As a result they should be used as a guide only. Your Vauxhall Retailer has a comprehensive display of our paint samples.



Black roof colour.



Malbec roof colour.

CASCADA FEATURES/OPTIONS

EXTERIOR COLOURS

		Roof colour / roof type	SE	Elite	Price (£) exc. VAT	Total (£) inc. VAT
	Darkmoon Blue • Two-coat premium paint	• Black roof • Dual-layer fabric	<input checked="" type="radio"/>	<input checked="" type="radio"/>	545.83	655.00
		• Black roof • Triple-layer acoustic fabric (£310)	<input type="radio"/>	<input type="radio"/>	804.17	965.00
	Rioja Red • Two-coat premium paint	• Black roof • Dual-layer fabric	<input checked="" type="radio"/>	<input checked="" type="radio"/>	545.83	655.00
		• Black roof • Triple-layer acoustic fabric (£310)	<input type="radio"/>	<input type="radio"/>	804.17	965.00
		• Malbec roof • Triple-layer acoustic fabric (£310)	<input type="radio"/>	<input type="radio"/>		

● = Standard equipment. ○ = Optional at extra cost.

The colours reproduced may vary slightly from the actual paint colour. As a result they should be used as a guide only. Your Vauxhall Retailer has a comprehensive display of our paint samples.



Black roof colour.



Malbec roof colour.

CASCADA FEATURES/OPTIONS



WHEELS AND TYRES

	SE	Elite	Price (£) exc. VAT	Total (£) inc. VAT
Emergency tyre inflation kit (in lieu of spare wheel)	●	●		
17-inch emergency steel spare wheel (in lieu of emergency tyre inflation kit)	○	○ ⁶	91.67	110.00
 18-inch 5-twinblade alloy wheels: 235/50 R 18 tyres	●			
 19-inch multi-spoke bi-colour alloy wheels: 235/45 R 19 tyres	○		633.33	760.00
 19-inch multi-spoke bi-colour alloy wheels: 235/45 R 19 tyres		N/C	No-cost option	
 20-inch 5-twinspoke bi-colour alloy wheels: 245/40 R 20 tyres		●		

● = Standard equipment. ○ = Optional at extra cost. N/C = No-cost option.

6 = Not available on 1.6i Turbo (200PS).

TYRE RATING

Tyre size	Fuel efficiency group	Wet grip performance	External noise	
			Measured (dB)	Group
235/50 R 18	E	B	71	
235/45 R 19	E	B	68	
245/40 R 20	E	B	71	

Tyre rating according to EU Regulation 1222/2009

CASCADA SPECIFICATIONS

PETROL ENGINES

	1.4i Turbo (140PS) with Start/Stop	1.6i Turbo (170PS)	1.6i Turbo (200PS) with Start/Stop
Capacity	1364cc	1598cc	1598cc
Maximum power	140PS (103kW) @ 4900-6000rpm	170PS (125kW) @ 4250rpm	200PS (147kW) @ 5500rpm
Maximum torque	200Nm (147 lb.ft.) @ 1850-4900rpm	260Nm (191 lb.ft.) @ 1650-4250rpm	280Nm (206 lb.ft.) @ 1650-3500rpm
Configuration	4 cylinders, 4 valves per cylinder, double overhead camshafts	4 cylinders, 4 valves per cylinder, double overhead camshafts	4 cylinders, 4 valves per cylinder, double overhead camshafts
Fuel/induction system	Water-cooled turbocharger with intercooler. Variable Valve Timing (VVT) Multi-point sequential fuel injection	Water-cooled turbocharger with intercooler. Variable Valve Timing (VVT) Central direct fuel injection	Water-cooled turbocharger with intercooler. Variable Valve Timing (VVT) Central direct fuel injection
Emission compliance	Euro 6	Euro 6	Euro 6
Service interval	20,000 miles or 1 year (whichever occurs sooner)	20,000 miles or 1 year (whichever occurs sooner)	20,000 miles or 1 year (whichever occurs sooner)

DIESEL ENGINES

	2.0CDTi (170PS) Turbo diesel with Start/Stop
Capacity	1956cc
Maximum power	170PS (125kW) @ 4000rpm
Maximum torque	400Nm (295 lb.ft.) @ 1750-2500rpm
Configuration	4 cylinders, 4 valves per cylinder, double overhead camshafts
Fuel/induction system	Variable geometry turbocharger with intercooler. Common rail fuel injection
Emission compliance	Euro 6
Service interval	20,000 miles or 1 year (whichever occurs sooner)

CASCADA SPECIFICATIONS

PERFORMANCE, FUEL ECONOMY AND EMISSIONS

	Wheel size (inches)	Performance (manufacturer's figures)		Fuel economy mpg (litres/100km)#			CO ₂ emissions g/km#	Vehicle Excise Duty*		Benefit in kind company car taxation rates – 2017/18 tax year
		Maximum speed (mph)	Acceleration 0-60mph (sec)	Urban driving	Extra-urban driving	Combined figure		First year rate	Standard rate	
<i>Petrol Manual</i>										
1.4i Turbo (140PS) Start/Stop	18/19/20	129	10.2	33.2 (8.5)	52.3 (5.4)	43.5 (6.5)	151	£500	£140	29%
1.6i Turbo (200PS) Start/Stop	19/20	146	8.2	31.0 (9.1)	51.4 (5.5)	40.9 (6.9)	158	£500	£140	30%
<i>Petrol Automatic</i>										
1.6i Turbo (170PS)	19/20	136	9.2	28.0 (10.1)	45.6 (6.2)	37.2 (7.6)	176	£800	£140	34%
<i>Diesel Manual</i>										
2.0CDTi (170PS) Start/Stop	19/20	135	9.6	47.1 (6.0)	67.3 (4.2)	57.6 (4.9)	129	£160	£140	27%

* = Correct at time of publication.

= Fuel consumption information is official government environmental data, tested in accordance with the relevant EU directive. Official EU-regulated test data is provided for comparison purposes and actual performance will depend on driving style, road conditions and other non-technical factors.

CASCADA SPECIFICATIONS

TRANSMISSION

Six-speed manual gearbox

Standard on: 1.4i Turbo (140PS)/1.6i Turbo (200PS)/2.0CDTi (170PS).

Six-speed automatic transmission with ActiveSelect® function

A six-speed automatic transmission is standard on 1.6i Turbo (170PS). On the road, a wide selection of shift patterns is adapted to the style and habits of the driver, anticipating when maximum acceleration or maximum efficiency is required. The electronic control will also adapt to the prevailing road conditions, reducing gear shifting when climbing or descending and using engine braking assistance during down changes.

The ActiveSelect® manual mode allows the gear lever to be used like a sequential manual gearbox – you simply push the lever forward or back to change up or down the gears. The driver also benefits from a 'neutral' gear disengagement at idle, which reduces vibration and contributes to improved fuel consumption.

STEERING

- Power-assisted steering
- Turning circle (kerb-to-kerb):
– 11.8m (38.3ft.)

SUSPENSION

The HiPerStrut (High Performance Strut) front suspension improves grip and allows more power to be applied during cornering. The reduced kingpin angle means less camber loss, which allows the front tyres to retain more of their contact patch with the road during cornering, therefore delaying the onset of understeer. The shorter spindle length significantly reduces torque steer reactions and improves resistance to steering kickback through uneven bends.

Front: Independent. HiPerStrut sports suspension with gas-pressure dampers and coil springs. Anti-roll bar.

Rear: Lightweight compound crank rear axle with one-piece, hollow cast trailing arms. Built-in anti-roll bar. Progressive-rate double conical mini-block springs with Watt's link and gas-pressure dampers.

BRAKES

- Anti-lock Braking System (ABS)
- Electronic brakeforce distribution
- Hydraulic brake fade assist
- Cornering brake control
- Emergency brake assist
- Electric parking brake with Hill start assist

FUEL TANK CAPACITY

All models: 56 litres (12.3 gallons)

WEIGHTS AND TOWING DATA kg

	Gross vehicle weight	Max. towing weights Trailer with brakes (without brakes)
1.4i Turbo (140PS) Start/Stop	2110	1250 (750)
1.6i Turbo (170PS) automatic	2150	1300 (750)
1.6i Turbo (200PS)	2140	1300 (750)
2.0CDTi (170PS) Start/Stop	2225	1300 (750)

Gross vehicle weight is the total permissible weight of the vehicle including passengers and their luggage. The maximum towing weights are based on the ability of the car, with two occupants of 75kg each, to restart on a 12% gradient, which is approximately 1 in 8.3, at sea level. At altitudes above 1500 metres, the engine output may drop with a corresponding reduction in towing capability. Any extra weight, such as luggage or additional passengers, should be deducted from the maximum towing weight. With a trailer fully loaded, maximum noseweight should not exceed 75kg. Always fit Vauxhall towing attachments and accessories available from your Vauxhall Retailer. They are designed specifically for Vauxhall models and carry a 12-month guarantee.

CASCADA SPECIFICATIONS

EXTERIOR DIMENSIONS millimetres (inches)

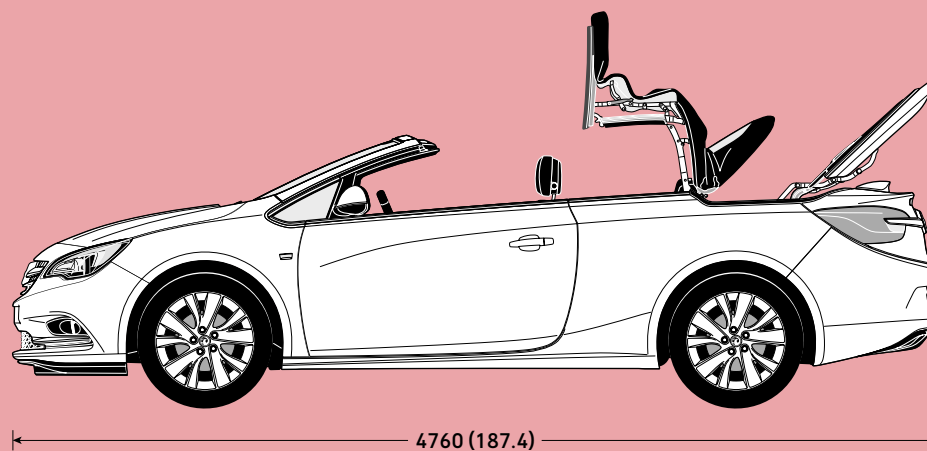
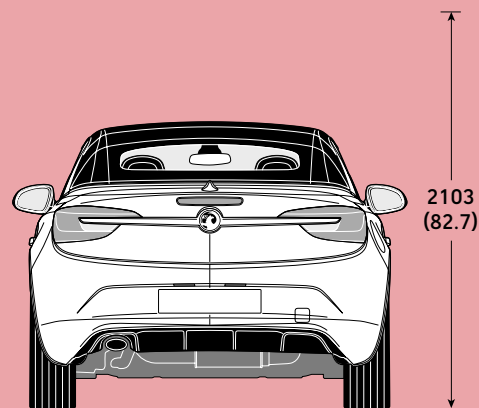
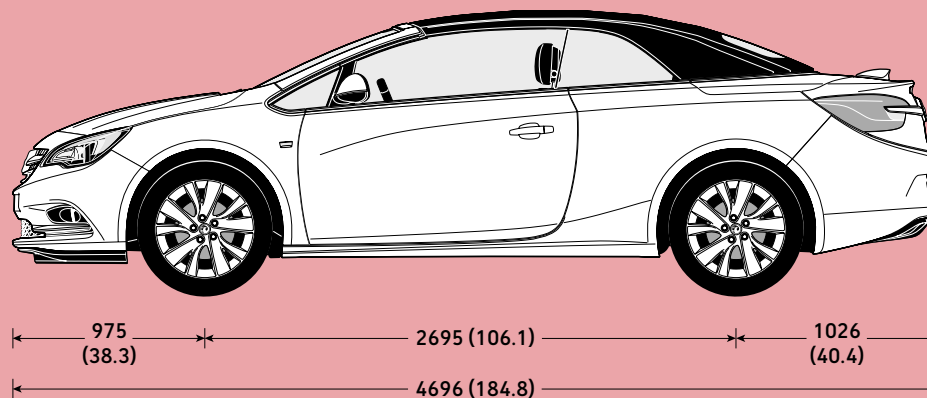
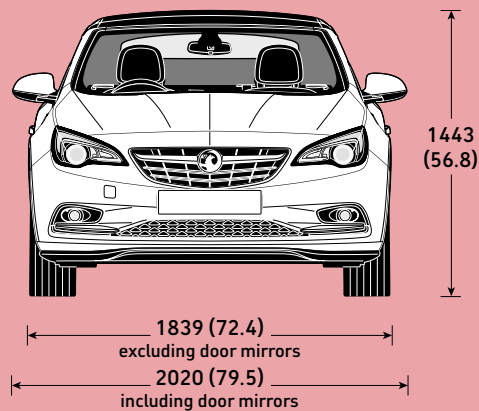

LUGGAGE CAPACITIES*

	litres (cu.ft.)
Rear seats up (roof closed)	380 (13.4)
Rear seats up (roof open)	280 (9.8)
Rear seats down (roof closed)	750 (26.4)
Rear seats down (roof open)	650 (22.9)

* = Measured using the ECIE method.

CASCADA ACCESSORIES

INFOTAINMENT

Sat Nav updates¹

Please consult your Retailer for latest map updates or visit www.vauxhall.co.uk/accessories.

1 = For use with optional factory-fit satellite navigation systems.

CHILD SEATS²

BABY-SAFE ³ – 0-13kg/birth to 15 months	£132.00
– ISOFIX base	£227.00
DUO ISOFIX ³ – 9-18kg/9 months to 4 years with top tether kit	£347.00
KID ³ – 15-36kg or 4 to 12 years	£157.00

2 = Restrictions apply to the use of child seats, please consult your Vauxhall Retailer or request a copy of the Child seats brochure.

3 = Without transponder.

INTERIOR

Console organiser	£16.00
– Note pad	£16.00
– Pen	£16.00
Aux-in cable	£6.00

SAFETY

Safety Pack – first aid kit, warning triangle, hi-visibility vest, Vauxhall bag	£35.00
First aid kit	£15.00
Warning triangle	£17.00
Hi-visibility vest	£9.00
Fire extinguisher – 2kg	£37.00
Temporary tyre inflation kit	£120.00
Tyre sealant	£68.00

SECURITY

Locking wheel bolts – set of four	£39.00
-----------------------------------	--------

FLEXCONNECT RANGE

FlexConnect bracket	£20.00
FlexConnect hook	£28.00
FlexConnect coat hanger	£58.00
FlexConnect folding table	£68.00
FlexConnect iPad Mini cradle	£98.00
FlexConnect iPad (1-4) cradle	£106.00
FlexConnect iPad Air cradle	£106.00
FlexConnect Samsung Galaxy cradle	£96.00

PRACTICAL

Spare bulb kit ⁴	£26.00
Premium spare bulb kit ⁴	£50.00
Wind deflector	
– front seat	£334.00
– rear seat	£90.00
Smoker pack	£34.00

4 = Excludes xenon headlight bulb for models with Adaptive Forward Lighting (AFL)

PROTECTION

Economy floor mats – set of four	£34.00
Rubber floor mats – set of four	£43.00
Velour floor mats – set of four (black or brandy)	£71.00
Car cover	£425.00
VX protect Cascada pack	Contact Retailer
Door sill plates	£67.00
Tailored load compartment net	£26.00
Luggage net	£21.00

TOURING

Detachable tow bar	
– 12N electrics	£685.00
– 12S electrics	£833.00
– 13-pin electrics	£735.00

STYLING

VX-Line pedal covers	
– manual	£113.00
– automatic	£135.00

ALLOY WHEELS (set of four with centre caps)⁵

19-inch 5-spoke	from £1137.00
20-inch 5-twin-spoke	from £1065.00

Other designs available

5 = Different tyres and locking wheel bolts/nuts may be required at extra cost. Price excludes new tyres and locking wheel bolts/nuts, includes static wheel balancing.

Please note:

Prices shown are a fully fitted and painted, where applicable and include VAT. Please check with your local Vauxhall Retailer for details. It is advisable to ensure your insurance policy is adequate to cover additional fitted accessories. Prices correct at time of publication.

CASCADA ADDITIONAL INFORMATION

ON-THE-ROAD PRICES

To eliminate uncertainty about hidden costs when buying a new car, Vauxhall publishes on-the-road recommended retail prices (RRP) and these are shown in the pricing tables within this price guide. These prices include VAT, number plates and delivery to Retailer of £700.00 (including £116.67 VAT), 12 months' Government Vehicle Excise Duty (see opposite for details) and the DVLA new vehicle first registration fee of £55.00*.

Please note: The on-the-road recommended retail price (RRP) does not include fuel supplied by the Retailer, motor insurance or any other goods or services supplied by agreement between the Retailer and the customer.

PRICE PROTECTION

Order a new Vauxhall for build in the current model year (as confirmed by your Retailer) for delivery no more than three months in advance and the price you are quoted is the price you pay. This is irrespective of any subsequent price rises between placing your order and delivery of your new car, but you must take delivery as soon as the car is available. Vauxhall Motors Limited is not liable for price adjustments caused by Government changes in the rate of VAT (currently 20%), Vehicle Excise Duty, DVLA new vehicle first registration fee or by any other applicable legislation or regulations.

VEHICLE EXCISE DUTY

The amount of Vehicle Excise Duty (road fund licence) payable on new cars varies depending on the level of carbon dioxide (CO₂) emissions produced by the vehicle. CO₂ emissions are measured in grammes (g) per kilometre (km) travelled and divided into 13 charging bands shown in the table below.

A 'first year rate' of Vehicle Excise Duty is payable on all new cars and in subsequent years the amount payable reverts to the 'standard rate'. From 1 April 2017 the breakpoints for each of these bands have been revised. Also, for vehicles with a list price over £40,000, including factory-fitted options, an additional £310 is payable for the first five years of standard rate payments.

Vehicle Excise Duty*

	CO ₂ emissions (g/km)	First year rate	Standard rate
Band A	0	£0.00	£0.00
Band B	1-50	£10.00	£140.00
Band C	51-75	£25.00	£140.00
Band D	76-90	£100.00	£140.00
Band E	91-100	£120.00	£140.00
Band F	101-110	£140.00	£140.00
Band G	111-130	£160.00	£140.00
Band H	131-150	£200.00	£140.00
Band I	151-170	£500.00	£140.00
Band J	171-190	£800.00	£140.00
Band K	191-225	£1200.00	£140.00
Band L	226-255	£1700.00	£140.00
Band M	over 255	£2000.00	£140.00

* = Correct at time of issue.

VAUXHALL LEASING

As Vauxhall's own contract hire and fleet management operation, Vauxhall Leasing provides a one-stop-shop for competitive car and van leasing solutions – for business users and private individuals. Working with the Vauxhall Retailer network, we combine the support of a national contract with the convenience of a local contact.

For further information, please see your local Vauxhall Retailer or call us on **0117 908 6433**. Alternatively, you can visit our website at www.vauxhall-leasing.co.uk

IN THE EVENT OF AN ACCIDENT...

Vauxhall Accident Management helps keep you mobile following an accident. Benefits include vehicle recovery, Vauxhall-approved repairs and contacting your insurer. For more details, visit vauxhall.co.uk/AccidentManagement

TRUST VAUXHALL

CUSTOMER CARE COMMITMENT

For added peace of mind, Vauxhall has an innovative Customer Care Commitment that offers the following:

- Three-year vehicle warranty consisting of a one-year/unlimited mileage manufacturer's warranty and a second and third year manufacturer's warranty with a 60,000 miles limitation
- Vauxhall Assistance for 12 months from first registration
- Six years' body panel anti-perforation warranty

Please note: Warranty is only available on vehicles sourced from Vauxhall Motors Limited. Terms and conditions apply – please see your Vauxhall Retailer for details.

VAUXHALL ASSISTANCE

Vauxhall Assistance is provided automatically with every new Vauxhall for 12 months from first registration and covers everything from accident assistance, roadside recovery and 'at home' service to flat tyres. With Vauxhall Assistance help is literally just a free* phone call away, 24 hours a day, 365 days a year!

* = Mobile phone users will be charged at their standard tariff.

PROTECTING THE ENVIRONMENT

Vauxhall's commitment to the environment is demonstrated by our products' many environmental awards. For even more information on Vauxhall's efforts to achieve an environmentally sustainable future, and how to dispose of your end-of-life vehicle, see www.vauxhall.co.uk/recycling

VAUXHALL SERVICE PLAN

- Fixed monthly payments for the plan duration
- Easy to budget and interest-free
- Genuine parts fitted by Vauxhall-trained technicians

Plus on Gold plans:

- Valet and courtesy car
- Full AA cover
- Engine flush and fuel treatments
- Litre of oil for top ups between services

Full details can be obtained from your local participating Vauxhall Retailer.

VAUXHALL INSURANCE WITH ADDED REASSURANCE

Comprehensive cover – Summary of benefits**

- Competitive premiums
- Repairs by a Vauxhall-trained technician
- Genuine Vauxhall parts, guaranteed for three years when we repair your car within our Approved Repairer Network
- Free courtesy car as standard when using an Approved Repairer†
- 24 hour claims helpline
- Personal Accident benefit
- Cover for audio equipment
- Windscreen cover

Call for a quote on 0844 463 2670††

** = The benefits listed above are for comprehensive cover only. For details of Third Party, Fire and Theft cover, please call our sales team.
† = Should your car need repairing following an accident we provide a courtesy car (subject to availability) for the duration of the repair. Only genuine Vauxhall parts are used. Terms and conditions apply.
†† = Calls may be recorded. Vauxhall Insurance is underwritten by Ageas Insurance Limited.

FOR MORE PRODUCT INFORMATION

For a brochure on any Vauxhall model (up to a maximum of three per caller) or location of your nearest Vauxhall Retailer please call **0345 600 1500**. Alternatively, details can be found on our website at www.vauxhall.co.uk

JOIN US ONLINE:



Privacy Policy – For full details please visit: vauxhall.co.uk/privacy

Vauxhall OnStar privacy details are available at vauxhall.co.uk/onstar

The invoice price, including delivery to Retailer, factory-fitted options, accessories fitted by the Retailer and number plates, is subject to VAT. Some feature descriptions in this guide may refer to, and some illustrations may show, optional equipment not included in the standard delivery. The information contained in this guide was accurate at the time of publication. We reserve the right to make changes in design and equipment. Please note that Vauxhall Retailers are not the agents of Vauxhall Motors Limited and are not authorised to bind Vauxhall Motors Limited by any specific or implied undertaking or representation. It is advisable to ensure that your motor insurance policy provides adequate cover for additional fitted options and accessories. The colours in this guide are only approximate actual colours. Illustrated optional equipment is available at extra charge. Availability, technical features and equipment provided on our vehicles can vary by model. For precise information on the equipment provided on our vehicles, please contact your local Vauxhall Retailer.

VAUXHALL

vauxhall.co.uk

©2017 Vauxhall Motors Limited

Published 19 December 2017 Vauxhall Motors Limited