

INSIGNIA PRICE/SPECIFICATION GUIDE

2 July 2015 | Model Year 2016



Proud Sponsor of Home Nations Football



INSIGNIA COMPANY CAR DRIVER/FLEET INFORMATION

DESIGN, TECH LINE AND TECH LINE GT. HIGH SPEC, LOW P11D

Specifically developed for businesses and company car drivers alike, our Design, Tech Line and Tech Line GT models are seriously fit for Fleet.

Design models (Insignia, Astra, and New Corsa) all feature very low P11D values, generous standard specification with a choice of high tech ecoFLEX engines for great fuel economy and low emissions including the new 'whisper diesel' 1.6CDTi (from 97g/km and 76.3mpg combined).

For even more standard specification, step up to our Tech Line range (Insignia, Astra, Mokka, Zafira Tourer and Meriva) again you are guaranteed low P11D values, plus great standard kit including Sat Nav (in lieu of parking sensors and Winter Pack on Meriva), Bluetooth®, USB connection, aux-in socket and digital radio (excluding Meriva).

For maximum impact, take a look at the Astra Tech Line GT with its dynamic sports styling.

With Design, Tech Line or Tech Line GT you can take for granted low Whole Life Costs and low company car driver taxation.

COMPANY CAR DRIVER FREE* 3 DAY TEST DRIVE

Our free* 3 Day Test Drive programme is open to all Company Car Drivers which allows you to choose any model in the current Vauxhall line-up (excluding Ampera, all VXR models and Commercial Vehicles), with full insurance cover provided, to give you a meaningful length of time to make an informed decision about your next company car.

Click below to book your free* test drive www.vauxhall3dtd.co.uk or call 0870 240 4848**



BENEFIT IN KIND COMPANY CAR TAXATION†

The car benefit charge will be the car's list price (including VAT, options and accessories fitted, delivery to retailer and number plates, but excluding Vehicle Excise Duty and new vehicle first registration fee) multiplied by the percentage charge for the CO₂ emissions band in which the car falls (see table opposite). Multiply this figure by your personal income tax rate (20% for Basic Rate, 40% for Higher Rate) to calculate your annual benefit in kind tax liability.

Example:

Insignia Tech Line 1.6CDTi 136PS Start/Stop ecoFLEX 5-door hatchback
(CO₂ emissions 99g/km)

On-the-road RRP	£22184.00
Deduct: Vehicle Excise Duty	(£0.00)
New vehicle first registration fee	(£55.00)
Effective list price	£22129.00
Add: Optional two-coat metallic paint	£545.00

List price for tax purposes (P11D value)
£22674.00

Car benefit charge	
2015-16 tax year (17%)	£3854.00
Benefit in kind tax liability (2015-16 tax year)	
Basic Rate (20%) tax payer	£770.00
Higher Rate (40%) tax payer	£1541.00

† = Please note this Price Guide provides taxation information as a guide only. Vauxhall does not provide taxation guidance. Drivers should always take professional advice on their own tax position.

*The free 3 Day Test Drive programme is open to Company Car Drivers and excludes fuel and lubricants; congestion charges; parking and speeding fines and the £250 insurance excess (if applicable). It features a wide selection of models from the Vauxhall range (excluding Ampera, all VXR models and Commercial Vehicles and subject to availability). Drivers must be aged 25 years or over, have held a full driving licence for at least a year and hold a major credit card. You will need to have your driving licence (and proof of identity (i.e. passport) where the driving licence is not a photocard licence) when your car is delivered. While every effort will be made to ensure that at least 3 days are provided for the test drive, this cannot always be guaranteed due to delivery and collection dates and timings. Available for UK Mainland only. Terms and conditions apply. **Telephone lines open Monday-Friday 9.00am to 5.00pm excluding Bank Holidays. Calls may be recorded or monitored for quality and/or training purposes.

CO ₂ emissions in grams per kilometre	Percentage of car's price to be taxed	
	Petrol 2015-16 tax year	Diesel 2015-16 tax year
up to 50	5	8
51-75	9	12
76-94	13	16
95-99	14	17
100-104	15	18
105-109	16	19
110-114	17	20
115-119	18	21
120-124	19	22
125-129	20	23
130-134	21	24
135-139	22	25
140-144	23	26
145-149	24	27
150-154	25	28
155-159	26	29
160-164	27	30
165-169	28	31
170-174	29	32
175-179	30	33
180-184	31	34
185-189	32	35
190-194	33	36
195-199	34	37
200-204	35	37
205-209	36	37
210 and above	37	37

To calculate your own personal liability a car tax calculator is available at: <https://www.vauxhallfleet.co.uk/toolbox>

FLEET TOOLBOX

Discover the facts in our online Toolbox for both Company Car Drivers and Fleet Decision Makers. The Fleet Toolbox has a host of useful calculators, comparators, interactive listings and information. Visit the Fleet Toolbox by going to www.vauxhall-toolbox.co.uk



ROADTRIP APP

The Vauxhall RoadTrip App is a free app that calculates and logs your mileage expenses for any UK business trips and generates reports to help you complete your mileage claims. Available for both iPhone and Android, visit www.vauxhall-toolbox.co.uk or visit the iPhone or Android stores and search for Vauxhall RoadTrip to download it to your smartphone or tablet.



CONTACT VAUXHALL FLEET

Please contact one of our dedicated sales teams who will be happy to help with your particular enquiry.

Company Car Drivers

Call: 0345 111 2020
Email: company-car@vauxhallinfo.co.uk

Telephone lines are open
– Monday to Friday 8.00am-9.00pm
– Saturday and Sunday 9.00am-6.00pm

Fleet Decision Makers

Depending on the size of your fleet of vehicles, we have a dedicated team to handle your enquiries. The lines are open Monday to Friday excluding Bank Holidays.

1-24 vehicles

Call: 0845 076 2254 (8.30am-5.00pm)
Email: b2bsales@vauxhall.co.uk

25+ vehicles

Call: 0870 010 0651 (8.30am-5.00pm)
Email: vauxhallfleet@vauxhall.co.uk

Special Vehicles (Police, Fire and Ambulance)

Call: 01525 408 320 (8.30am-5.00pm)
Email: vauxhallspecialvehicles@vauxhall.co.uk

INSIGNIA CUSTOMER OFFERS

At Vauxhall we know that customers appreciate flexibility. Not only do we have an extensive range of Insignia models to choose from, on some of them you can also take advantage of our Flexible Finance offer. Here's how it works:

0% APR
REPRESENTATIVE
FLEXIBLE FINANCE



1 CHOOSE YOUR CAR
Select a new vehicle.

2 CHOOSE YOUR DEPOSIT

3 CHOOSE YOUR TERM
From 24 to 60 months.

For even more great deals contact your local retailer or call 0345 600 1500 or visit www.vauxhall.co.uk/offers

TERMS AND CONDITIONS: Available on selected models only, at participating retailers. Conditional Sale. Finance subject to status. Terms and Conditions apply. Applicants must be 18 or over. Finance supplied by Vauxhall Finance, PO Box 6666, Cardiff, CF15 7YT. 24-60 month term. Offer will apply to private individuals, Vauxhall Partners and small businesses 1- 24 units (purchase only, excluding B2B supported units). All other customers are excluded. Refer to www.vauxhall.co.uk/offers or contact your local Vauxhall retailer for details.

INSIGNIA RANGE HIGHLIGHTS

DESIGN

£16,944-£24,299

- Digital radio
- Bluetooth® connectivity
- USB connection and aux-in socket
- CD/MP3 CD player/stereo radio (R400 Colour)
- LED daytime running lights
- 17-inch Structure wheel with 225/55 R 17 tyres
- Emergency tyre inflation kit (in lieu of spare wheel)
- Tyre pressure monitoring system
- Leather-covered steering wheel
- Cruise control
- Trip computer
- Electric four-way lumbar adjustment on driver's seat
- Electric height-adjustable driver's seat
- Remote control security alarm
- Remote control central deadlocking
- Six airbags
- Electronic Stability Programme (ESP)
- Electronic climate control
- Electric parking brake
- Automatic lighting control
- Electrically operated front windows
- Electrically adjustable/heated door mirrors
- Steering column adjustable for reach and rake
- Visible single exhaust tailpipe (2.0CDTi 170PS manual models only)

ENERGY

£20,399-£25,494

Feature over Design

- 18-inch 10-twinspoke alloy wheels with 245/45 R 18 tyres

LIMITED EDITION

£21,749-£28,169

Features over Design

- Vauxhall OnStar
- 18-inch bi-colour alloy wheels with 245/45 R 18 tyres
- Body-colour front spoiler, side sills, rear lip spoiler (not available on Sports Tourer) and rear lower skirt
- VX-Line leather-covered electrically heated sports steering wheel
- VX-Line leather-covered gear knob (manual models only)
- Sports pedals
- Electrically heated sports front seats
- Front and rear parking distance sensors
- Front fog lights
- High-pressure headlight washers
- Visible single exhaust tailpipe

SRI

£18,744-£26,099

Features over Design

- 17-inch 7-spoke alloy wheels with 225/55 R 17 tyres
- Lowered and uprated sports suspension
- Lowered and modified suspension (ecoFLEX models only)
- Sports pedals (excluding ecoFLEX models)
- Leather-covered sports steering wheel (excluding ecoFLEX models)
- Driver's ergonomic sports seat with extendable seat cushion
- Front fog lights
- Electrically operated rear windows
- Dark-tinted rear windows

SRi VX-Line

£22,554-£27,319

Features over SRi

- 19-inch atomic alloy wheels with 245/40 R 19 tyres
- Body-colour front spoiler, side sills, rear lip spoiler (hatchback) and rear lower skirt
- VX-Line leather-covered sports steering wheel
- VX-Line leather-covered gear knob (manual models only)
- Visible single exhaust tailpipe (excluding 2.0i Turbo)
- Visible dual branch exhaust tailpipes (2.0i Turbo)

SE

£19,544-£24,409

Features over Design

- 17-inch 7-spoke alloy wheels with 225/55 R 17 tyres
- Electrically operated rear windows
- Rain-sensitive windscreen wipers
- Automatic lighting control with tunnel detection
- Anti-dazzle rear-view mirror
- Chrome-effect side window surround

TECH LINE

£20,394-£26,099

Features over Design

- Navi 900 IntelliLink
- 17-inch 7-spoke alloy wheels with 225/55 R 17 tyres
- Anti-dazzle rear-view mirror
- Automatic lighting control with tunnel detection
- Rain-sensitive windscreen wipers
- Electrically operated rear windows
- Chrome-effect side window surround

ELITE

£23,964-£28,729

Features over SE

- Vauxhall OnStar
- Dual-zone electronic climate control
- 18-inch 10-spoke alloy wheels with 245/45 R 18 tyres
- Front and rear parking distance sensors
- Front fog lights
- Intelligent AFL with high-pressure headlight washers
- Leather trim with heated front seats
- Eight-way electrically adjustable driver's seat with memory
- Electric height and lumbar adjustment for front passenger's seat
- Electrically foldable door mirrors
- Dark-tinted rear windows (Sports Tourer)

INSIGNIA HATCHBACK PRICES*

Model 5-door hatchback	Price (£)	VAT (£)	Total (£)	On-the-road RRP (£)	CO ₂ (g/km)	Model 5-door hatchback	Price (£)	VAT (£)	Total (£)	On-the-road RRP (£)	CO ₂ (g/km)
DESIGN						SRI					
1.8i 140PS	13245.00	2649.00	15894.00	16944.00	169	1.8i 140PS	14745.00	2949.00	17694.00	18744.00	169
1.4i 140PS Turbo Start/Stop	14157.50	2831.50	16989.00	17744.00	124	1.4i 140PS Turbo Start/Stop	15657.50	3131.50	18789.00	19544.00	129
<i>Diesel</i>						<i>Diesel</i>					
1.6CDTi 136PS Start/Stop ecoFLEX	15649.17	3129.83	18779.00	19534.00	99	1.6CDTi 136PS Start/Stop ecoFLEX	17149.17	3429.83	20579.00	21334.00	99
1.6CDTi 136PS auto	17020.00	3404.00	20424.00	21179.00	129	1.6CDTi 136PS Start/Stop	17149.17	3429.83	20579.00	21334.00	109
2.0CDTi 170PS Start/Stop ecoFLEX**	16315.83	3263.17	19579.00	20334.00	114	1.6CDTi 136PS auto	18520.00	3704.00	22224.00	23109.00	132
2.0CDTi 170PS auto**	17686.67	3537.33	21224.00	22124.00	143	2.0CDTi 170PS Start/Stop ecoFLEX**	17815.83	3563.17	21379.00	22134.00	114
DESIGN NAV†						2.0CDTi 170PS Start/Stop**					
1.8i 140PS	13953.33	2790.67	16744.00	17794.00	169	2.0CDTi 170PS auto**	19186.67	3837.33	23024.00	23924.00	147
1.4i 140PS Turbo Start/Stop	14865.83	2973.17	17839.00	18594.00	124	SRI NAV†					
<i>Diesel</i>						<i>Diesel</i>					
1.6CDTi 136PS Start/Stop ecoFLEX	16357.50	3271.50	19629.00	20384.00	99	1.8i 140PS	15453.33	3090.67	18544.00	19594.00	169
1.6CDTi 136PS auto	17728.33	3545.67	21274.00	22029.00	129	1.4i 140PS Turbo Start/Stop	16365.83	3273.17	19639.00	20394.00	129
2.0CDTi 170PS Start/Stop ecoFLEX**	17024.17	3404.83	20429.00	21184.00	114	<i>Diesel</i>					
2.0CDTi 170PS auto**	18395.00	3679.00	22074.00	22974.00	143	1.6CDTi 136PS Start/Stop ecoFLEX	17857.50	3571.50	21429.00	22184.00	99
ENERGY						1.6CDTi 136PS Start/Stop					
1.8i 140PS	16124.17	3224.83	19349.00	20399.00	169	1.6CDTi 136PS auto	19228.33	3845.67	23074.00	23959.00	132
1.4i 140PS Turbo Start/Stop	17036.67	3407.33	20444.00	21199.00	129	2.0CDTi 170PS Start/Stop ecoFLEX**	18524.17	3704.83	22229.00	22984.00	114
<i>Diesel</i>						2.0CDTi 170PS Start/Stop**					
1.6CDTi 136PS Start/Stop ecoFLEX	18457.50	3691.50	22149.00	22904.00	104	2.0CDTi 170PS auto**	19895.00	3979.00	23874.00	24774.00	147
1.6CDTi 136PS auto	19828.33	3965.67	23794.00	24679.00	132	LIMITED EDITION VAUXHALL Star					
2.0CDTi 170PS Start/Stop ecoFLEX**	19124.17	3824.83	22949.00	23704.00	118	1.8i 140PS	17249.17	3449.83	20699.00	21749.00	169
2.0CDTi 170PS auto**	20495.00	4099.00	24594.00	25494.00	147	1.4i 140PS Turbo Start/Stop	18161.67	3632.33	21794.00	22549.00	129
LIMITED EDITION VAUXHALL Star						<i>Diesel</i>					
1.6CDTi 136PS Start/Stop ecoFLEX	19582.50	3916.50	23499.00	24254.00	104	1.6CDTi 136PS auto	20953.33	4190.67	25144.00	26029.00	132
1.6CDTi 136PS auto	20953.33	4190.67	25144.00	26029.00	132	2.0CDTi 170PS Start/Stop ecoFLEX**	20249.17	4049.83	24299.00	25054.00	118
2.0CDTi 170PS Start/Stop ecoFLEX**	20249.17	4049.83	24299.00	25054.00	118	2.0CDTi 170PS auto**	21620.00	4324.00	25944.00	26844.00	147
2.0CDTi 170PS auto**	21620.00	4324.00	25944.00	26844.00	147						

Please note: On-the-road recommended retail prices (RRP) include number plates and delivery to retailer of £700.00 (inc. £116.67 VAT), 12 months' Vehicle Excise Duty and new vehicle first registration fee of £55.00. Excludes fuel and insurance.

* = Saloon models are available as special order only, please consult your retailer for details. ** = This engine features new BlueInjection technology. For more information, visit www.vauxhall.co.uk/blueinjection. † = Fitted with Navi 900 IntelliLink satellite navigation system with 8-inch colour touch-screen/stereo radio/CD/MP3 CD player; aux-in, USB sockets/audio streaming/IntelliLink/shark fin aerial.

INSIGNIA HATCHBACK PRICES*

Model 5-door hatchback	Price (£)	VAT (£)	Total (£)	On-the-road RRP (£)	CO ₂ (g/km)
SRI VX-LINE					
2.0i 250PS Turbo Start/Stop	18128.33	3625.67	21754.00	22804.00	169
2.0i 250PS Turbo auto	19645.00	3929.00	23574.00	24819.00	186
<i>Diesel</i>					
1.6CDTi 136PS Start/Stop	18165.83	3633.17	21799.00	22554.00	109
1.6CDTi 136PS auto	19536.67	3907.33	23444.00	24329.00	132
2.0CDTi 170PS Start/Stop ecoFLEX**	18832.50	3766.50	22599.00	23354.00	118
2.0CDTi 170PS auto**	20203.33	4040.67	24244.00	25144.00	147
SRI VX-LINE NAV†					
2.0i 250PS Turbo Start/Stop	18836.67	3767.33	22604.00	23654.00	169
2.0i 250PS Turbo auto	20353.33	4070.67	24424.00	25669.00	186
<i>Diesel</i>					
1.6CDTi 136PS Start/Stop	18874.17	3774.83	22649.00	23404.00	109
1.6CDTi 136PS auto	20245.00	4049.00	24294.00	25179.00	132
2.0CDTi 170PS Start/Stop ecoFLEX**	19540.83	3908.17	23449.00	24204.00	118
2.0CDTi 170PS auto**	20911.67	4182.33	25094.00	25994.00	147
SE					
1.4i 140PS Turbo Start/Stop	15657.50	3131.50	18789.00	19544.00	124
<i>Diesel</i>					
1.6CDTi 136PS Start/Stop ecoFLEX	17149.17	3429.83	20579.00	21334.00	99
1.6CDTi 136PS auto	18520.00	3704.00	22224.00	22979.00	129
2.0CDTi 170PS Start/Stop ecoFLEX**	17815.83	3563.17	21379.00	22134.00	114
2.0CDTi 170PS auto**	19186.67	3837.33	23024.00	23924.00	143
TECH LINE†					
1.4i 140PS Turbo Start/Stop	16365.83	3273.17	19639.00	20394.00	124
<i>Diesel</i>					
1.6CDTi 136PS Start/Stop ecoFLEX	17857.50	3571.50	21429.00	22184.00	99
1.6CDTi 136PS auto	19228.33	3845.67	23074.00	23829.00	129
2.0CDTi 170PS Start/Stop ecoFLEX**	18524.17	3704.83	22229.00	22984.00	114
2.0CDTi 170PS auto**	19895.00	3979.00	23874.00	24774.00	143

Model 5-door hatchback	Price (£)	VAT (£)	Total (£)	On-the-road RRP (£)	CO ₂ (g/km)
ELITE VAUXHALL OnStar					
<i>Diesel</i>					
1.6CDTi 136PS Start/Stop ecoFLEX	19340.83	3868.17	23209.00	23964.00	104
1.6CDTi 136PS auto	20711.67	4142.33	24854.00	25739.00	132
2.0CDTi 170PS Start/Stop ecoFLEX**	20007.50	4001.50	24009.00	24764.00	118
2.0CDTi 170PS auto**	21378.33	4275.67	25654.00	26554.00	147
ELITE NAV VAUXHALL OnStar†					
<i>Diesel</i>					
1.6CDTi 136PS Start/Stop ecoFLEX	20049.17	4009.83	24059.00	24814.00	104
1.6CDTi 136PS auto	21420.00	4284.00	25704.00	26589.00	132
2.0CDTi 170PS Start/Stop ecoFLEX**	20715.83	4143.17	24859.00	25614.00	118
2.0CDTi 170PS auto**	22086.67	4417.33	26504.00	27404.00	147

Please note: On-the-road recommended retail prices (RRP) include number plates and delivery to retailer of £700.00 (inc. £116.67 VAT), 12 months' Vehicle Excise Duty and new vehicle first registration fee of £55.00. Excludes fuel and insurance.

* = Saloon models are available as special order only, please consult your retailer for details. ** = This engine features new BlueInjection technology. For more information, visit www.vauxhall.co.uk/blueinjection. † = Fitted with Navi 900 IntelliLink satellite navigation system with 8-inch colour touch-screen/stereo radio/CD/MP3 CD player, aux-in, USB sockets/audio streaming/IntelliLink/shark fin aerial.

INSIGNIA SPORTS TOURER PRICES

Model Sports Tourer	Price (£)	VAT (£)	Total On-the-road (£)	RRP (£)	CO ₂ (g/km)	Model Sports Tourer	Price (£)	VAT (£)	Total On-the-road (£)	RRP (£)	CO ₂ (g/km)
DESIGN						SRI VX-LINE					
1.4i 140PS Turbo Start/Stop	15245.00	3049.00	18294.00	19179.00	131	2.0i 250PS Turbo Start/Stop	19211.67	3842.33	23054.00	24104.00	174
<i>Diesel</i>						<i>Diesel</i>					
1.6CDTi 136PS Start/Stop ecoFLEX	16732.50	3346.50	20079.00	20834.00	104	1.6CDTi 136PS Start/Stop	19249.17	3849.83	23099.00	23854.00	114
2.0CDTi 170PS Start/Stop ecoFLEX*	17399.17	3479.83	20879.00	21634.00	119	2.0CDTi 170PS Start/Stop*	19915.83	3983.17	23899.00	24654.00	124
2.0CDTi 170PS auto*	18790.83	3758.17	22549.00	23449.00	145	2.0CDTi 170PS auto*	21307.50	4261.50	25569.00	26469.00	149
DESIGN NAV**						SRI VX-LINE NAV**					
1.4i 140PS Turbo Start/Stop	15953.33	3190.67	19144.00	20029.00	131	2.0i 250PS Turbo Start/Stop	19920.00	3984.00	23904.00	24954.00	174
<i>Diesel</i>						<i>Diesel</i>					
1.6CDTi 136PS Start/Stop ecoFLEX	17440.83	3488.17	20929.00	21684.00	104	1.6CDTi 136PS Start/Stop	19957.50	3991.50	23949.00	24704.00	114
2.0CDTi 170PS Start/Stop ecoFLEX*	18107.50	3621.50	21729.00	22484.00	119	2.0CDTi 170PS Start/Stop*	20624.17	4124.83	24749.00	25504.00	124
2.0CDTi 170PS auto*	19499.17	3899.83	23399.00	24299.00	145	2.0CDTi 170PS auto*	22015.83	4403.17	26419.00	27319.00	149
ENERGY						SE					
<i>Diesel</i>						<i>Diesel</i>					
1.6CDTi 136PS Start/Stop ecoFLEX	19540.83	3908.17	23449.00	24204.00	109	1.6CDTi 136PS Start/Stop ecoFLEX	18232.50	3646.50	21879.00	22634.00	104
2.0CDTi 170PS Start/Stop*	20207.50	4041.50	24249.00	25004.00	124	1.6CDTi 136PS auto	19603.33	3920.67	23524.00	24409.00	134
LIMITED EDITION VAUXHALL OnStar						TECH LINE**					
<i>Diesel</i>						<i>Diesel</i>					
1.6CDTi 136PS Start/Stop ecoFLEX	20665.83	4133.17	24799.00	25554.00	109	1.6CDTi 136PS Start/Stop ecoFLEX	18940.83	3788.17	22729.00	23484.00	104
2.0CDTi 170PS Start/Stop*	21332.50	4266.50	25599.00	26354.00	124	1.6CDTi 136PS auto	20311.67	4062.33	24374.00	25259.00	134
2.0CDTi 170PS auto*	22724.17	4544.83	27269.00	28169.00	149	2.0CDTi 170PS Start/Stop ecoFLEX*	19607.50	3921.50	23529.00	24284.00	119
SRI						ELITE VAUXHALL OnStar					
<i>Diesel</i>						<i>Diesel</i>					
1.6CDTi 136PS Start/Stop ecoFLEX	18232.50	3646.50	21879.00	22634.00	104	1.6CDTi 136PS Start/Stop ecoFLEX	20424.17	4084.83	24509.00	25264.00	109
1.6CDTi 136PS Start/Stop	18232.50	3646.50	21879.00	22634.00	114	2.0CDTi 170PS Start/Stop*	21090.83	4218.17	25309.00	26064.00	124
2.0CDTi 170PS Start/Stop ecoFLEX*	18899.17	3779.83	22679.00	23434.00	119	2.0CDTi 170PS auto*	22482.50	4496.50	26979.00	27879.00	149
2.0CDTi 170PS Start/Stop*	18899.17	3779.83	22679.00	23434.00	124	ELITE NAV VAUXHALL OnStar **					
2.0CDTi 170PS auto*	20290.83	4058.17	24349.00	25249.00	149	<i>Diesel</i>					
SRI NAV**						ELITE NAV VAUXHALL OnStar **					
<i>Diesel</i>						<i>Diesel</i>					
1.6CDTi 136PS Start/Stop ecoFLEX	18940.83	3788.17	22729.00	23484.00	104	1.6CDTi 136PS Start/Stop ecoFLEX	21132.50	4226.50	25359.00	26114.00	109
1.6CDTi 136PS Start/Stop	18940.83	3788.17	22729.00	23484.00	114	2.0CDTi 170PS Start/Stop*	21799.17	4359.83	26159.00	26914.00	124
2.0CDTi 170PS Start/Stop ecoFLEX*	19607.50	3921.50	23529.00	24284.00	119	2.0CDTi 170PS auto*	23190.83	4638.17	27829.00	28729.00	149
2.0CDTi 170PS Start/Stop*	19607.50	3921.50	23529.00	24284.00	124	Please note: On-the-road recommended retail prices (RRP) include number plates and delivery to retailer of £700.00 (inc. £116.67 VAT), 12 months' Vehicle Excise Duty and new vehicle first registration fee of £55.00. Excludes fuel and insurance.					
2.0CDTi 170PS auto*	20999.17	4199.83	25199.00	26099.00	149	* = This engine features new BlueInjection technology. For more information, visit www.vauxhall.co.uk/blueinjection . ** = Fitted with Navi 900 IntelliLink satellite navigation system with 8-inch colour touch-screen/stereo radio/CD/MP3 CD player, aux-in, USB sockets/audio streaming/IntelliLink/shark fin aerial.					

INSIGNIA FEATURES/OPTIONS

SAFETY

Standard features

Airbags: • Driver's dual-stage airbag • Front passenger's dual-stage airbag • Front seat side-impact airbags • Full-size curtain airbags • Deactivation switch for front passenger's airbags

Seating: • Height-adjustable head restraints on outer rear seats • Five lap and diagonal inertia-reel seatbelts (height-adjustable front) • Front body-lock diagonal seatbelt pretensioner system • Driver's lap belt pretensioner system • Front seatbelt force limiters • Anti-submarining ramps in front seats • ISOFIX child seat restraint system for all rear seats incorporating top tether (does not include child seat)

Electronic: • Electronic Stability Programme-plus (ESP-plus) • Anti-lock Braking System (ABS) • Cornering brake control • Emergency brake assist • Straight line stability control • Traction control • Adaptive brake lights • Electric parking brake • Hill start assist (manual models only) • Tyre pressure monitoring system

Body: • Energy-absorbing steering column • Pedal release system • Laminated windscreen • Side-impact protection beams • Reinforced passenger safety cell • Deformation zones front and rear • Burst-proof door locks and anti-jam door design

Pedestrian: • Multi-pivot bonnet hinges • Low density foam near front bumper crossmember • Plastic lower front bumper stiffener

	Design	Energy	Limited Edition	SRI	SRI VX-Line	SE	Tech Line	Elite	Price (£) exc. VAT	Total (£) inc. VAT
Additional features										
Active-safety front seat head restraints				●	●					
Height-adjustable centre rear seat head restraint	□		□	□	□	□	□	●		
Park and Go Technology Pack ¹ • Side blind spot alert • Lane change alert • Rear crossing traffic alert	○	○	○	○	○	○	○	○	416.67	500.00

SECURITY

Standard features • Remote control security alarm system • Remote control central deadlocking (doors/tailgate, fuel flap) • Visible Vehicle Identification Number (VIN) plate • 'Key left in ignition' audible warning • Electronic engine deadlock immobiliser • Door-to-door illumination • Foldable key • Driver's internal central locking switch

	Design	Energy	Limited Edition	SRI	SRI VX-Line	SE	Tech Line	Elite	Price (£) exc. VAT	Total (£) inc. VAT
Additional features										
Locking wheel nuts for alloy wheels (where fitted)	●	●	●	●	●	●	●	●		
Keyless entry and start	○	○	○	○	○	○	○	○	329.17	395.00

HEATING AND VENTILATION

Standard features • Air blend heater • Side window demist vents and adjustable face-level air vents • Air recirculation system with activation light • Interior pollen filter • Rear passenger compartment heating ducts

	Design	Energy	Limited Edition	SRI	SRI VX-Line	SE	Tech Line	Elite	Price (£) exc. VAT	Total (£) inc. VAT
Additional features										
Single-zone electronic climate control incorporating air conditioning	●	●	●	●	●	●	●			
Dual-zone electronic climate control incorporating air conditioning with variable side-to-side temperature settings, multi-zone sun sensor and humidity sensor	□	□	□	□	□	○	○	●	329.17	395.00
Premium Sensory Pack • Dual-zone electronic climate control incorporating air conditioning • Tunnel detection for automatic lighting control • Rain-sensitive windscreen wipers • Electro-chromatic anti-dazzle rear-view mirror	○	○	○	○	○			●	412.50	495.00

● = Standard equipment. ○ = Optional at extra cost. □ = Available as part of an extra-cost option pack.

¹ = Only available in conjunction with rear-view camera.

INSIGNIA FEATURES/OPTIONS

AUDIO, COMMUNICATION AND NAVIGATION

	Design	Energy	Limited Edition	SRi	SRi VX-Line	SE	Tech Line	Elite	Price (£) exc. VAT	Total (£) inc. VAT
R400 Colour • CD/MP3 CD player • AM/FM stereo radio with 25 station presets • USB connection and aux-in socket • 4.2-inch colour monitor • RDS with Traffic Programme • 20 watts per channel output • 6 speakers • Roof-mounted flexible aerial	●	●	●	●	●	●		●		
Touch R700 IntelliLink • CD/MP3 CD player • AM/FM stereo radio • 60 configurable favourites including phone contacts, addresses, playlists and radio stations • USB connection and aux-in socket • Audio streaming • IntelliLink • 8-inch colour touch-screen display • RDS with Traffic Programme • 20 watts per channel output • 7 speakers • Shark fin aerial	○	○	○	○	○	○		○	291.67	350.00
Navi 900 IntelliLink • Satellite navigation system • CD/MP3 CD player • AM/FM stereo radio • 60 configurable favourites including phone contacts, addresses, playlists and radio stations • USB connection and aux-in socket • Audio streaming • IntelliLink • 8-inch colour touch-screen display • RDS with Traffic Programme • 20 watts per channel output • 7 speakers • Shark fin aerial	▲	○	○	▲	▲	○	●	▲	1000.00	1200.00
Vauxhall OnStar	○	○	●	○	○	○	○	●	329.17	395.00
Steering wheel mounted audio controls	●	●	●	●	●	●	●	●		
Bluetooth® connectivity	●	●	●	●	●	●	●	●		
Digital radio	●	●	●	●	●	●	●	●		
BOSE® Premium Sound System² • 4x45w channels • Bose® digital amplifier with six channels of customised equalisation • 7 premium speakers • Subwoofer	○	○	○	○	○	○	○	○	437.50	525.00

● = Standard equipment. ○ = Optional at extra cost. ▲ = See price pages for details.

² = Luggage capacity will be reduced.

Vauxhall OnStar

Once only the preserve of premium brands, our people friendly personal connectivity and service assistant is now available across the Vauxhall car range. Vauxhall OnStar is a new, one-of-a-kind system that gives you in-car access to a host of innovations at the touch of a button. 24/7, 365 days a year you are connected to a qualified advisor – not to a machine. In the event of a crash, OnStar even automatically calls for help. Vauxhall OnStar also transforms your Vauxhall into a Wi-Fi Hotspot and turns your smartphone into a remote control for your car*.

Find out more about the full range of OnStar services at www.vauxhall.co.uk/onstar.html
Vauxhall OnStar – Your personal connectivity and service assistant.

* Some features may not be available in your region, for your carline, or trim level. Please check www.vauxhall.co.uk/onstar.html for a current overview of potential restrictions.

TOUCH R700 INTELLILINK

Upgrade to the optional Touch R700 IntelliLink and effortlessly connect to your preferred choice of digital media. Using the clear 8-inch colour touch-screen, it's easy to contact clients and colleagues, friends and family – and access all the information you need, on demand. It's also possible to re-configure the optional displays with a choice of 60 personal favourites. This allows you to prioritise icons and select key information on the centre console display – just as you would on a home computer screen. That's everything from your favourite bands to your most listened to radio stations, to phone contacts and music playlists. In addition, Apple iPhone users can project functions using Apple CarPlay as follows:

- Siri voice control
- Basic services including, maps, phone, messaging and music
- Supports third party apps

As you would expect of such an advanced system, Touch R700 also offers video playback and audio streaming via Bluetooth®-enabled devices.

NAVI 900 INTELLILINK

For easy, hands-free operation, upgrade to Navi 900, with touch-screen and IntelliLink technology. This advanced, interactive sat nav unit understands voice commands for destination input. Additional features include pan-European sat nav menus, video playback and audio streaming via Bluetooth®. Navi 900 IntelliLink is fitted as standard on Tech Line and Nav models.

8-INCH DIGITAL COLOUR SCREEN

With Insignia, key information is no longer confined to the centre console. You can read off infotainment, phone and sat nav menus located within the instrument cluster display. The controls themselves are conveniently mounted on the steering wheel. The 8-inch digital colour screen is optional at extra cost on all models fitted with the R700 IntelliLink and Navi 900 IntelliLink system.

BOSE® SOUND SYSTEM

The optional Bose® sound system delivers unprecedented performance, immersing you and your passengers in high quality surround sound. Features include: 4x45w channels, a six-channel digital amplifier which automatically equalises the sound depending on driving style/conditions, 7 premium speakers and a subwoofer.

INSIGNIA FEATURES/OPTIONS

FACIA, INSTRUMENTS AND CONTROLS

Standard features • Leather-covered three-spoke steering wheel • Driver information centre incorporating multi-function trip computer • Cruise control with speed limiter function • Rev counter • Coolant temperature gauge • Fuel gauge • Digital clock with automatic RDS time adjustment • Multi-function display showing time, date, audio information and outside air temperature • Steering column adjustable for reach and rake • Electronic odometer and trip odometer • Instrument panel light dimmer

	Design	Energy	Limited Edition	SRI	SRI VX-Line	SE	Tech Line	Elite	Price (£) exc. VAT	Total (£) inc. VAT
Additional features										
8-inch digital colour screen speedometer with supplementary audio, phone and navigation information ³	○	○	○	○	○	○	○	○	333.33	400.00
Leather-covered three-spoke sports steering wheel ⁴				●						
VX-Line leather-covered three-spoke sports steering wheel, leather-covered gear knob (manual models only) and dark headlining			●	□	●			□		
Electrically heated leather-covered steering wheel (only in conjunction with leather seat facings)	○		●	○	○	○	○	○	162.50	195.00
Winter Pack 1 ⁵ • Electrically heated front seats • High-pressure headlight washers • Electrically heated leather-covered steering wheel	○	○	●	○	○	○	○	○	579.17	695.00
Winter Pack 2 ⁶ • Electrically heated front seats • Electrically heated leather-covered steering wheel	○	○		○	○	○	○		416.67	500.00
Winter Pack 3 ⁷ • Electrically heated leather-covered steering wheel • High-pressure headlight washers	○			○	○	○	○		329.17	395.00
Front camera system incorporating traffic sign recognition, lane departure warning, forward collision alert, following distance indicator and heat-reflective windscreen ⁸	○	○	○	○	○	○	○	○	625.00	750.00
Adaptive cruise control incorporating front camera system (includes 'Stop and Go' function on automatic models) ^{8,9}	○	○	○	○	○	○	○	○	916.67	1100.00

INTERIOR AND CONVENIENCE FEATURES

Standard features • Storage box on driver's side lower fascia • Lidded glovebox • Front and rear door pockets • Twin sunvisors incorporating illuminated driver's and front passenger's vanity mirrors with covers • 12-volt auxiliary power socket in front centre console • Chrome internal door handles • Hinged luggage compartment cover (hatchback) • Carpeted rear seat back • Fully carpeted luggage area • Retractable luggage compartment cover (Sports Tourer) • Boot/luggage area sill protection • Stainless steel trim on luggage compartment lip (Sports Tourer) • Load restraint lashing eyes • DualFloor luggage compartment (Sports Tourer)

	Design	Energy	Limited Edition	SRI	SRI VX-Line	SE	Tech Line	Elite	Price (£) exc. VAT	Total (£) inc. VAT
Additional features										
Trigo Cool inserts on fascia and doors	●	●	●	● ¹⁰						
Diamo Black inserts on fascia and doors				● ¹¹	●			● ¹²		
Echelon Cool inserts on fascia and doors						●	●	● ¹³		
Wood-effect inserts on fascia and doors (with Saddle Up interior trim)						●		●		
Sports pedals			●	● ¹¹	●			□		
Electro-chromatic anti-dazzle rear-view mirror	□	□	□	□	□	●	●	●		
FlexOrganiser® Pack (Sports Tourer) • Four side rails • 3D storage net • Side net pocket • Four side rail hooks	○	○	○	○	○	○	○	○	91.67	110.00

● = Standard equipment. ○ = Optional at extra cost. □ = Available as part of an extra-cost option pack.

³ = Only available in conjunction with optional IntelliLink audio units. ⁴ = Sports steering wheel is replaced by a non-perforated leather-covered three-spoke steering wheel on ecoFLEX models or when the optional Winter Packs or electrically heated steering wheel are specified. ⁵ = Not available in conjunction with leather seat facings or Adaptive Forward Lighting. ⁶ = Only available in conjunction with Adaptive Forward Lighting. Not available with leather seat facings. ⁷ = Only available in conjunction with leather seat facings. Not available with Adaptive Forward Lighting. ⁸ = Only available in conjunction with Sight and Light Pack and either front and rear parking distance sensors or advanced park assist. ⁹ = Includes forward collision alert with automatic brake intervention. Not available on 1.8i or 1.4i Turbo models. ¹⁰ = Standard on ecoFLEX models only. ¹¹ = Standard on all models except ecoFLEX models. ¹² = Fitted as part of the Premium Nappa Leather Pack. ¹³ = Fitted with black Siena and perforated Siena interior trim.

INSIGNIA FEATURES/OPTIONS

INTERIOR LIGHTING

Standard features • Fade up/fade down courtesy lights operated by front and rear door switches • Illuminated luggage area and glovebox • Map reading lights • Front courtesy light • Two rear reading lights • Illuminated driver's and front passenger's footwells • Interior ambient lighting

SEATING AND UPHOLSTERY

Standard features • Driver's seat with electrical four-way lumbar adjustment • Driver's seat with tilt and electrical height adjustment • Front passenger's seat with reach and rake adjustment • Front centre armrest with storage facility • Storage pockets on front seat backs

	Design	Energy	Limited Edition	SRi	SRi VX-Line	SE	Tech Line	Elite	Price (£) exc. VAT	Total (£) inc. VAT
Additional features										
Front passenger's seat comfort pack incorporating six-way manual adjustment with electrical height and four-way lumbar adjustment. Also includes lap belt pretensioner system	○	○	○ ¹⁴	○ ¹⁴	○ ¹⁴	○	○	●	254.17	305.00
Driver's seat with eight-way electrical adjustment and memory function								●		
Sports front seats with ergonomic AGR* driver's seat including extendable seat cushion	○ ¹⁵		●	●	●	○ ¹⁵	○ ¹⁵	□	345.83	415.00
Lyra cloth seat trim	●									
Drive cloth seat trim		●								
Ribbon cloth seat trim	○ ¹⁶		●	●	●	○ ¹⁶	○ ¹⁶			
Quantum cloth seat trim						●	●			
Sport Seats Leather Pack • Sports front seats, driver's ergonomic AGR*, with extendable seat cushions • Perforated leather seat facings • Electrically heated front seats • Fold-out rear seat centre armrest with load-through facility • Height-adjustable centre rear seat head restraint			○ ¹⁷	○	○				954.17	1145.00
Sport Seats Leather Pack • Sports front seats, driver's ergonomic AGR*, with extendable seat cushions • Perforated leather seat facings • Electrically heated front seats • Fold-out rear seat centre armrest with load-through facility • Height-adjustable centre rear seat head restraint								○	345.83	415.00
Comfort Leather Pack • Leather seat facings • Electrically heated front seats • Fold-out rear seat centre armrest with load-through facility • Height-adjustable centre rear seat head restraint	○ ¹⁷					○	○	●	870.83	1045.00
Premium Nappa Leather Pack • Ergonomic AGR* sports front seats with extendable seat cushions • Nappa leather seat upholstery • Leather-trimmed head restraints, door panels and centre armrest • Electrically heated front seats • VX-Line leather-covered sports steering wheel and, on manual models, gear knob • Sports pedals • Diamo black inserts on fascia and doors • Fold-out rear seat centre armrest with load-through facility				○ ¹⁸	○			○	2550.00	3060.00
Electrically heated front seats	□	□	●	□	□	□	□	●		

REAR PASSENGER COMPARTMENT

	Design	Energy	Limited Edition	SRi	SRi VX-Line	SE	Tech Line	Elite	Price (£) exc. VAT	Total (£) inc. VAT
Features										
12-volt auxiliary power socket behind front seats	●	●	●	●	●	●	●	●		
Fold-out rear seat centre armrest with load-through facility	□		□	□	□	□	□	●		
60/40 split-folding rear seat back	●	●	●	●	●	●	●	●		

● = Standard equipment. ○ = Optional at extra cost. □ = Available as part of an extra-cost option pack. * = AGR (The Campaign for Healthier Backs) is an independent centre of excellence for ergonomics, based in Germany.

¹⁴ = Includes extendable seat cushions. ¹⁵ = Ribbon cloth seat trim replaces Lyra cloth on Design models and Quantum cloth on SE/Tech Line models. ¹⁶ = Fitted in conjunction with optional sports front seats. Not available separately. ¹⁷ = Also includes electrically operated rear windows. ¹⁸ = Not available on ecoFLEX models.

INSIGNIA FEATURES/OPTIONS

PLUS PACKS

	Design	Energy	Limited Edition	SRi	SRi VX-Line	SE	Tech Line	Elite	Price (£) exc. VAT	Total (£) inc. VAT
Design Plus Pack • 18-inch alloy wheels with 245/45 R 18 tyres • Front fog lights	○								408.33	490.00
SE Plus Pack • 18-inch alloy wheels with 245/45 R 18 tyres • Front fog lights						○			408.33	490.00
Tech Line Plus Pack • 18-inch alloy wheels with 245/45 R 18 tyres • Front fog lights							○		408.33	490.00

EXTERIOR LIGHTING

Standard features • LED daytime running lights • Lights-on audible warning • LED centre brake light • LED tail lights (hatchback models feature reflectors on the tailgate, replaced by LED lights when optional adaptive forward lighting is specified)

	Design	Energy	Limited Edition	SRi	SRi VX-Line	SE	Tech Line	Elite	Price (£) exc. VAT	Total (£) inc. VAT
Additional features										
Automatic lighting control	●	●	●	●	●					
Automatic lighting control with tunnel detection	□	□	□	□	□	●	●	●		
Front fog lights	□		●	●	●	□	□	●		
Electric headlight beam levelling	●	●	●	●	●	●	●			
High-pressure headlight washers			●					●		
Intelligent Adaptive Forward Lighting (AFL) incorporating bi-xenon headlights with dynamic beam levelling, high beam assist and high-pressure headlight washers ¹⁹	○	○	○	○	○	○	○	●	741.67	890.00

EXTERIOR AND CONVENIENCE FEATURES

Standard features • Electrically operated front windows with one-touch facility • Twin electrically adjustable/heated door mirrors (wide-angle on driver's side) with automatic timed cut-off • Touch-sensitive tailgate release • Tinted glass • Heated rear window with automatic timed cut-off • Intermittent rear window wash/wipe • Twin gas-assisted tailgate struts

	Design	Energy	Limited Edition	SRi	SRi VX-Line	SE	Tech Line	Elite	Price (£) exc. VAT	Total (£) inc. VAT
Additional features										
Sight and Light Pack • Tunnel detection for automatic lighting control	○	○	○	○	○	●	●	●	191.67	230.00
• Rain-sensitive windscreen wipers • Electro-chromatic anti-dazzle rear-view mirror										
Electrically foldable door mirrors (electro-chromatic anti-dazzle on driver's side)	○ ²⁰	○ ²⁰	○ ²⁰	○ ²⁰	○ ²⁰	○	○	●	150.00	180.00
Electrically operated rear windows with safety autoreverse	○ ²¹	○	○ ²¹	●	●	●	●	●	141.67	170.00
Front and rear parking distance sensors	○	○	●	○	○	○	○	●	375.00	450.00
Advanced park assist with front and rear parking distance sensors ²²	○	○	○	○	○	○	○	○	416.67	500.00
Rear-view camera (only available with Navi 900 audio unit)	○	○	○	○	○	○	○	○	250.00	300.00
Retractable tow bar with 13-pin socket ²³	○	○	○	○	○	○	○	○	562.50	675.00
Electrically operated tailgate – Sports Tourer only	○ ²⁴	○ ²⁴	○ ²⁴	○	○	○	○	●	308.33	370.00

● = Standard equipment. ○ = Optional at extra cost. □ = Available as part of an extra-cost option pack.

¹⁹ = Also includes Sight and Light Pack. On hatchback models the reflectors on the tailgate are replaced by LED lights. ²⁰ = Only available in conjunction with optional Sight and Light Pack, Premium Sensory Pack or Adaptive Forward Lighting. ²¹ = Fitted in conjunction with optional Leather Pack.

²² = Not available in conjunction with front and rear parking distance sensors. ²³ = Not available on 1.4i Turbo Sports Tourer models. ²⁴ = Only available in conjunction with electrically operated rear windows.

INSIGNIA FEATURES/OPTIONS

EXTERIOR STYLING AND PROTECTION

Standard features • Chrome-effect upper grille surround • Body-colour door mirrors • Body-colour door handles • White indicators and side repeaters

	Design	Energy	Limited Edition	SRi	SRi VX-Line	SE	Tech Line	Elite	Price (£) exc. VAT	Total (£) inc. VAT
Additional features										
Chrome-effect side window surround						●	●	●		
Chrome-effect door handles – fitted in conjunction with optional keyless entry and start, not available separately	○	○	○	○	○	○	○	○		
Silver-effect roof rails (Sports Tourer only)	●	●	●	●	●	●	●	●		
Dark-tinted rear windows – hatchback models	○	○	○	●	●	○	○	○	229.17	275.00
Dark-tinted rear windows – Sports Tourer models	○	○	○	●	●	○	○	●	229.17	275.00
Body-colour rear lip spoiler (hatchback only)	●	●	●	●	●	●	●	●		
Visible single exhaust tailpipe (2.0CDTi 170PS models only)	● ²⁵	● ²⁵	●	● ²⁵	●	● ²⁵	● ²⁵	● ²⁵		
Visible dual branch exhaust tailpipes (2.0i Turbo)					●					
VXR Styling Pack • Body-colour front spoiler, side sills, rear lip spoiler and rear lower skirt (rear lip spoiler not available on Sports Tourer) • Visible exhaust tailpipe			●	○ ²⁶	●	○	○	○	700.00	840.00
Brilliant paint	○	○	○	○	○	○	○	○	229.17	275.00
Two-coat metallic or pearlescent paint	○	○	○	○	○	○	○	○	454.17	545.00

FLEXRIDE SYSTEM AVAILABILITY





	Design	Energy	Limited Edition	SRi	SRi VX-Line	SE	Tech Line	Elite	Price (£) exc. VAT	Total (£) inc. VAT
1.4i 140PS Turbo	○	○	○	○		○	○		658.33	790.00
2.0i 250PS Turbo					●					
2.0CDTi 170PS/2.0CDTi 170PS ecoFLEX	○	○	○	○	○	○	○	○	658.33	790.00

● = Standard equipment. ○ = Optional at extra cost.

²⁵ = Manual models only. ²⁶ = Not available on 1.6CDTi 136PS Start/Stop ecoFLEX models.

INSIGNIA FEATURES/OPTIONS

WHEELS AND TYRES

	Design	Energy	Limited Edition	SRI	SRI VX-Line	SE	Tech Line	Elite	Price (£) exc. VAT	Total (£) inc. VAT
Emergency tyre inflation kit (in lieu of spare wheel)	●	●	●	●	●	●	●	●		
17-inch steel spare wheel (in lieu of emergency tyre inflation kit)	○ ²⁷	○		○ ²⁸		○ ²⁸	○ ²⁸	○ ²⁸	79.17	95.00
17-inch steel space-saver spare wheel (in lieu of emergency tyre inflation kit)	○ ²⁹	○		○ ²⁸		○ ²⁸	○ ²⁸	○ ²⁸	79.17	95.00
 17-inch structure wheels: ³⁰ 225/55 R 17 tyres	●									
 17-inch 7-spoke alloy wheels: ³⁰ 225/50 R 17 tyres				●		●	●			
 18-inch 10-twinspoke alloy wheels: ³¹ 245/45 R 18 tyres	□	●				□	□			
 18-inch bi-colour alloy wheels: 245/45 R 18 tyres			●							





● = Standard equipment. ○ = Optional at extra cost. □ = Available as part of an extra-cost option pack.

²⁷ = Only available in conjunction with optional 17-inch structure wheels or Design Plus Pack. ²⁸ = Not available in conjunction with VXR Styling Pack. ²⁹ = Only available in conjunction with Plus Pack. ³⁰ = Design, SE, Tech Line and SRI ecoFLEX models feature ultra-low rolling resistance tyres.

³¹ = Please note optional alloy wheels can affect fuel consumption and CO₂ emissions, resulting in higher Vehicle Excise Duty and Benefit in Kind. See Performance, Fuel and Emissions tables for more information.

INSIGNIA FEATURES/OPTIONS

WHEELS AND TYRES



	Design	Energy	Limited Edition	SRI	SRI VX-Line	SE	Tech Line	Elite	Price (£) exc. VAT	Total (£) inc. VAT
 18-inch 10-spoke alloy wheels: 245/45 R 18 tyres								●		
 18-inch 5-twinblade alloy wheels:³¹ 245/45 R 18 tyres				○ ²⁶					129.17	155.00
 19-inch atomic alloy wheels: 245/40 R 19 tyres			○		●				425.00	510.00
 19-inch turbine alloy wheels:³¹ 245/40 R 19 tyres				○ ³²					470.83	565.00
 19-inch turbine alloy wheels:³¹ 245/40 R 19 tyres					○				83.33	100.00

● = Standard equipment. ○ = Optional at extra cost.

²⁶ = Not available on 1.6CDTi 136PS Start/Stop ecoFLEX and 2.0CDTi 170PS ecoFLEX models. ³¹ = Please note optional alloy wheels can affect fuel consumption and CO₂ emissions, resulting in higher Vehicle Excise Duty and Benefit in Kind. See Performance, Fuel and Emissions tables for more information. ³² = Not available in conjunction with 17-inch steel spare wheel or 1.6CDTi 136PS ecoFLEX and 2.0CDTi 170PS ecoFLEX models.

INSIGNIA FEATURES/OPTIONS

WHEELS AND TYRES

	Design	Energy	Limited Edition	SRI	SRI VX-Line	SE	Tech Line	Elite	Price (£) exc. VAT	Total (£) inc. VAT
 20-inch bi-colour alloy wheels: ³¹ 245/35 R 20 tyres				○ ³²	○				725.00	870.00
 19-inch 10-spoke alloy wheels: 245/40 R 19 tyres								○ ³³	383.33	460.00
 20-inch multi-spoke alloy wheels: 245/35 R 20 tyres								○ ³³	725.00	870.00

● = Standard equipment. ○ = Optional at extra cost.

³¹ = Please note optional alloy wheels can affect fuel consumption and CO₂ emissions, resulting in higher Vehicle Excise Duty and Benefit in Kind. See Performance, Fuel and Emissions tables for more information. ³² = Not available in conjunction with 17-inch steel spare wheel or 1.6CDTi 136PS ecoFLEX and 2.0CDTi 170PS ecoFLEX models. ³³ = Not available in conjunction with 17-inch steel spare wheel.

TYRE RATING

Tyre size	Fuel efficiency group	Wet grip performance	External noise	
			Measured (dB)	Group
225/50 R 17	C	C	71	(C-1)
225/55 R 17	B-E	B	71	(C-1)
245/45 R 18	C-E	B	68-76	(C-1-1)
245/40 R 19	E	B	68	(C-1)
245/35 R 20	E	B	71	(C-1)

Tyre rating according to EU Regulation 1222/2009

INSIGNIA SPECIFICATIONS

PETROL ENGINES

	1.8i 140PS ECOTEC-4	1.4i 140PS Turbo ECOTEC-4 Start/Stop	2.0i 250PS ECOTEC-4 Turbo with and without Start/Stop
Capacity	1796cc	1364cc	1998cc
Maximum power	140PS (103kW) @ 6300rpm	140PS (103kW) @ 4900-6000rpm	250PS (184kW) @ 5300rpm
Maximum torque	175Nm (129 lb.ft.) @ 3800rpm	200Nm (147 lb.ft.) @ 1850-4900rpm	400Nm (295 lb.ft.) @ 2500-4000rpm
Configuration	4 cylinders, 4 valves per cylinder, double overhead camshafts	4 cylinders, 4 valves per cylinder, double overhead camshafts	4 cylinders, 4 valves per cylinder, double overhead camshafts
Fuel/induction system	Naturally aspirated Variable Valve Timing (VVT). Multi-point sequential fuel injection	Turbocharger with intercooler. Variable Valve Timing (VVT). Multi-point sequential fuel injection	Twin-scroll turbocharger with intercooler. Direct fuel injection
Emission compliance	Euro 6	Euro 6	Euro 6
Service interval	20,000 miles or 1 year (whichever occurs sooner)	20,000 miles or 1 year (whichever occurs sooner)	20,000 miles or 1 year (whichever occurs sooner)

TURBO DIESEL ENGINES

	1.6CDTi 136PS ECOTEC-4 with and without Start/Stop	2.0CDTi 170PS ECOTEC-4 with and without Start/Stop
Capacity	1598cc	1956cc
Maximum power	136PS (100kW) @ 3500-4000rpm	170PS (125kW) @ 3500-4000rpm
Maximum torque	320Nm (236 lb.ft.) @ 2000rpm	400Nm (295 lb.ft.) @ 1750-2500rpm
Configuration	4 cylinders, 4 valves per cylinder, double overhead camshafts	4 cylinders, 4 valves per cylinder, double overhead camshafts
Fuel/induction system	Variable geometry turbocharger with intercooler. Common rail fuel injection	Variable geometry turbocharger with intercooler. Common rail fuel injection
Emission compliance	Euro 6 with Diesel Particulate Filter	Euro 6 with Diesel Particulate Filter
Service interval	20,000 miles or 1 year (whichever occurs sooner)	20,000 miles or 1 year (whichever occurs sooner)

INSIGNIA SPECIFICATIONS

PERFORMANCE, FUEL ECONOMY AND EMISSIONS – HATCHBACK MODELS

	Wheel size (inches)	Performance (manufacturer's figures)		Fuel economy mpg (litres/100km)#			CO ₂ emissions g/km#	Vehicle Excise Duty*		Benefit in kind company car taxation rates – 2015/16 tax year
		Maximum speed (mph)	Acceleration 0-62mph (sec)	Urban driving	Extra-urban driving	Combined figure		First year rate	Standard rate	
Manual										
1.8i 140PS	17/18/19/20	127	11.5	27.4 (10.3)	50.4 (5.6)	38.7 (7.3)	169	£295	£205	28%
1.4i 140PS Turbo Start/Stop Design/SE/Tech Line	17	127	10.9	40.4 (7.0)	65.7 (4.3)	53.3 (5.3)	124	£0	£110	19%
1.4i 140PS Turbo Start/Stop SRi	17	127	10.9	39.2 (7.2)	62.8 (4.5)	51.4 (5.5)	129	£0	£110	20%
1.4i 140PS Turbo Start/Stop	18/19/20	127	10.9	39.2 (7.2)	62.8 (4.5)	51.4 (5.5)	129	£0	£110	20%
2.0i 250PS Turbo Start/Stop	19/20	155	7.5	29.1 (9.7)	48.7 (5.8)	39.2 (7.2)	169	£295	£205	28%
1.6CDTi 136PS Start/Stop ecoFLEX Design/SE/Tech Line/SRi	17	130	10.9	62.8 (4.5)	85.6 (3.3)	74.3 (3.8)	99	£0	£0	17%
1.6CDTi 136PS Start/Stop ecoFLEX (excluding SRi)	18/19/20	130	10.9	60.1 (4.7)	80.7 (3.5)	72.4 (3.9)	104	£0	£20	18%
1.6CDTi 136PS Start/Stop SRi	17/18/19/20	127	10.9	57.6 (4.9)	76.3 (3.7)	68.9 (4.1)	109	£0	£20	19%
2.0CDTi 170PS Start/Stop ecoFLEX Design/SE/Tech Line/SRi	17	139	9.0	51.4 (5.5)	78.5 (3.6)	65.7 (4.3)	114	£0	£30	20%
2.0CDTi 170PS Start/Stop ecoFLEX (excluding SRi)	18/19/20	139	9.0	50.4 (5.6)	74.3 (3.8)	62.8 (4.5)	118	£0	£30	21%
2.0CDTi 170PS Start/Stop SRi	17/18/19/20	139	9.0	50.4 (5.6)	74.3 (3.8)	62.8 (4.5)	118	£0	£30	21%
Automatic										
2.0i 250PS Turbo	19/20	152	7.7	25.9 (10.9)	45.6 (6.2)	35.8 (7.9)	186	£490	£265	32%
1.6CDTi 136PS Design/SE/Tech Line	17	124	10.9	44.1 (6.4)	70.6 (4.0)	57.6 (4.9)	129	£0	£110	23%
1.6CDTi 136PS SRi	17	124	10.9	43.5 (6.5)	68.9 (4.1)	56.5 (5.0)	132	£130	£130	24%
1.6CDTi 136PS	18/19/20	124	10.9	43.5 (6.5)	68.9 (4.1)	56.5 (5.0)	132	£130	£130	24%
2.0CDTi 170PS Design/SE/Tech Line	17	137	9.4	37.2 (7.6)	68.9 (4.1)	52.3 (5.4)	143	£145	£145	26%
2.0CDTi 170PS	17/18/19/20	137	9.4	36.2 (7.8)	67.3 (4.2)	50.4 (5.6)	147	£145	£145	27%

PERFORMANCE, FUEL ECONOMY AND EMISSIONS – SPORTS TOURER MODELS

	Wheel size (inches)	Performance (manufacturer's figures)		Fuel economy mpg (litres/100km)#			CO ₂ emissions g/km#	Vehicle Excise Duty*		Benefit in kind company car taxation rates – 2015/16 tax year
		Maximum speed (mph)	Acceleration 0-62mph (sec)	Urban driving	Extra-urban driving	Combined figure		First year rate	Standard rate	
Manual										
1.4i 140PS Turbo Start/Stop	17	124	11.5	38.7 (7.3)	61.4 (4.6)	50.4 (5.6)	131	£130	£130	21%
1.4i 140PS Turbo Start/Stop	18	124	11.5	37.7 (7.5)	58.9 (4.8)	48.7 (5.8)	136	£130	£130	22%
2.0i 250PS Turbo Start/Stop	19/20	152	7.8	28.2 (10.0)	47.9 (5.9)	38.2 (7.4)	174	£295	£205	29%
1.6CDTi 136PS Start/Stop ecoFLEX Design/SE/Tech Line/SRi	17	127	11.4	61.4 (4.6)	78.5 (3.6)	72.4 (3.9)	104	£0	£20	18%
1.6CDTi 136PS Start/Stop ecoFLEX (excluding SRi)	18/19/20	127	11.4	58.9 (4.8)	76.3 (3.7)	68.9 (4.1)	109	£0	£20	19%
1.6CDTi 136PS Start/Stop SRi	17/18/19/20	124	11.4	55.4 (5.1)	72.4 (3.9)	65.7 (4.3)	114	£0	£30	20%
2.0CDTi 170PS Start/Stop ecoFLEX Design/SE/Tech Line/SRi	17	137	9.4	49.6 (5.7)	74.3 (3.8)	62.8 (4.5)	119	£0	£30	21%
2.0CDTi 170PS Start/Stop	17/18/19/20	137	9.4	48.7 (5.8)	70.6 (4.0)	60.1 (4.7)	124	£0	£110	22%
Automatic										
1.6CDTi 136PS	17/18	121	11.4	43.5 (6.5)	67.3 (4.2)	55.4 (5.1)	134	£130	£130	24%
2.0CDTi 170PS Design/Tech Line	17	134	9.9	36.7 (7.7)	67.3 (4.2)	51.4 (5.5)	145	£145	£145	27%
2.0CDTi 170PS	17/18/19/20	134	9.9	36.2 (7.8)	64.2 (4.4)	49.6 (5.7)	149	£145	£145	27%

* = Correct at time of publication.

= Official Government Test Environmental Data. Official EU-regulated test data is provided for comparison purposes and actual performance will depend on driving style, road conditions and other non-technical factors.

INSIGNIA SPECIFICATIONS

WEIGHTS AND TOWING DATA^{kg}

	Gross vehicle weight		Max. towing weights Trailer with brakes (without brakes)	
	Hatchback	Sports Tourer	Hatchback	Sports Tourer
1.8i 140PS	2040	–	1400 (750)	–
1.4i 140PS Turbo	2065	2140	1250 (730)	1200 (750)
2.0i 250PS Turbo	2160	2280	1800 (750)	1800 (750)
2.0i 250PS Turbo automatic	2175	2300	1800 (750)	1800 (750)
1.6CDTi 136PS ecoFLEX	2120	2250	1800 (750)	1700 (750)
1.6CDTi 136PS automatic	2140	2280	1800 (750)	1700 (750)
2.0CDTi 170PS ecoFLEX	2180	2310	1800 (750)	1800 (750)
2.0CDTi 170PS automatic	2210	2320	1800 (750)	1800 (750)

Gross vehicle weight is the total permissible weight of the vehicle including passengers and their luggage. The maximum roof rack loading should not exceed 100kg. The maximum towing weights are based on the ability of the car, with two occupants of 75kg each, to restart on a 12% gradient, which is approximately 1 in 8.3, at sea level. At altitudes above 1500 metres, the engine output may drop with a corresponding reduction in towing capability. Any extra weight, such as luggage or additional passengers, should be deducted from the maximum towing weight. With a trailer fully loaded, maximum noseweight should not exceed 85kg. Always fit Vauxhall towing attachments and accessories available from your Vauxhall retailer. They are designed specifically for Vauxhall models and carry a 12-month guarantee.

TRANSMISSION

Six-speed manual gearbox

Standard on all models

Six-speed automatic transmission with ActiveSelect® function

Available on 1.6CDTi 136PS/2.0CDTi 170PS/2.0i 250PS Turbo models.

- Electronically controlled with adaptive driving function
- Fluid drive with torque converter, lock-up clutch, neutral control fuel-saving feature and ActiveSelect®
- Steering wheel mounted paddle-shift for fingertip sequential gear changes (fitted in conjunction with VX-Line leather-covered sports steering wheel)

STEERING

- Power-assisted steering
- Turning circle (kerb-to-kerb): – 11.4m (37.4ft.)

SUSPENSION

Front: Independent. Lightweight MacPherson struts with gas-pressure dampers and coil springs. Anti-roll bar.

Rear: Lightweight multi-link with rising-rate mini-block coil springs and gas-pressure dampers. Anti-roll bar.

- SRi – lowered sports suspension

FlexRide (Adaptive Stability Technology) system

FlexRide offers drivers the choice of three distinct driving modes – Normal (default setting), Sport or Tour.

- Sport mode: This stiffens the car's suspension and sharpens steering and throttle responses. It also raises the threshold at which the ESP and traction control systems are activated, enhancing dynamic performance.
- Tour mode: Ideal for long motorway journeys, the Tour mode adjusts the dampers to a softer setting to create a perceptibly smoother ride and further enhance Insignia's ride comfort
- Continuous damping control: Utilises data from up to 11 variables including acceleration, braking and cornering to constantly control the suspension for optimum stability, driver engagement and comfort. Operates in all three driving modes
- Gas-filled rear dampers: Insignia's rear dampers are increased to 37mm diameter for enhanced performance

BRAKES

- Anti-lock Braking System (ABS)
- Dual circuit, diagonally split braking system
- Disc brakes all round

FUEL TANK CAPACITY

All models: 70 litres (15.4 gallons)

INSIGNIA SPECIFICATIONS

EXTERIOR DIMENSIONS millimetres (inches)

Hatchback

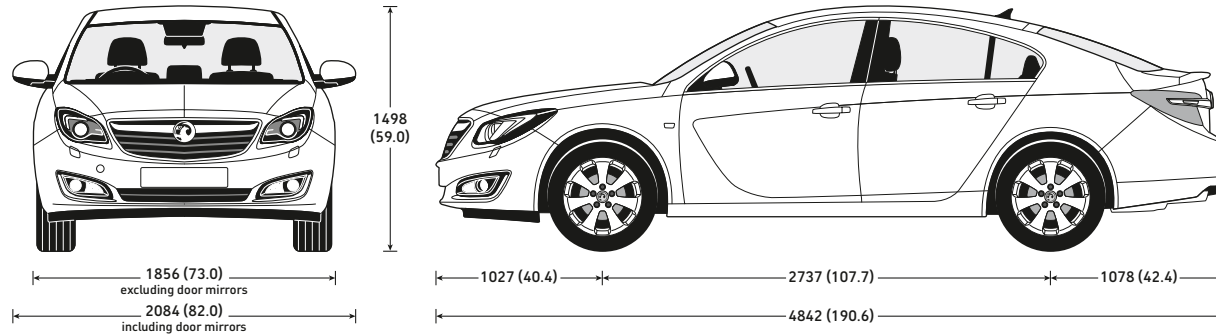

Sports Tourer

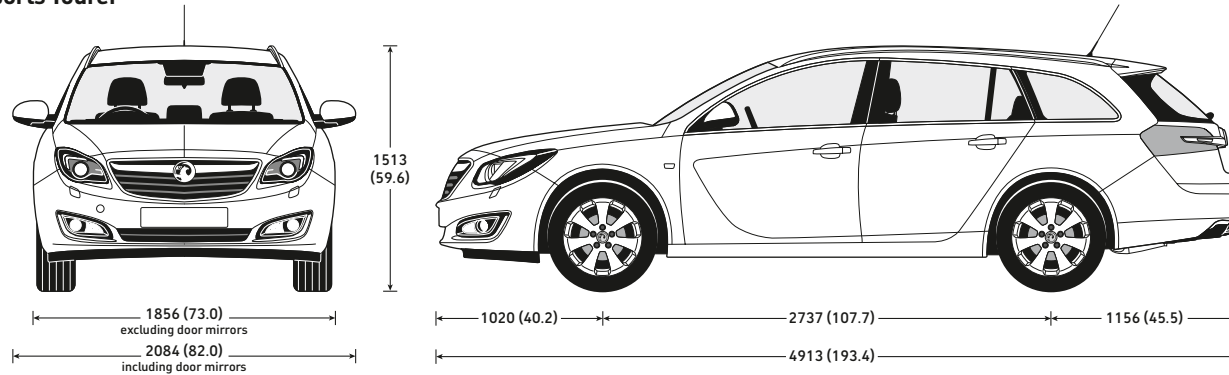

LOADSPACE DIMENSIONS millimetres (inches)

	Sports Tourer
Maximum load floor length – rear seats folded	1908 (75.1)
Maximum load floor length – rear seats up	1086 (42.8)
Maximum rear floor width	1060 (41.7)
Maximum load area height	778 (30.6)
Loading height from ground level (unladen)	659 (25.9)/ 670 (26.4)
Maximum tailgate aperture width	1064 (41.9)
Maximum tailgate aperture height	684 (26.9)

LUGGAGE CAPACITIES* litres (cu.ft.)

	Load volume (minimum)	Load volume (maximum)
Hatchback	530 (18.7)**	1470 (51.9)†
Sports Tourer	540 (19.0)	1530 (54.0)†

Please note fitment of BOSE® Premium Sound System reduces luggage capacity.
 * = Measured using the ECIE method. ** = Under luggage compartment cover – rear seats up.
 † = To roof – rear seats folded.

INSIGNIA ACCESSORIES

	Total (inc. VAT)
INFOTAINMENT	
iPod connection kit	
Connects2 i-Connect FM – FM modular	£129.00
Bury Bluetooth® phone kits	
Classic – Fully integrated, phone charging function, illuminated controls	£129.00
CC9060 – Fully integrated, detachable colour screen, voice recognition	£149.00
Garmin Portable Sat Navs (includes case)	
Nüvi 42 (UK/Ireland) – 4.3-inch screen	£79.00
Nüvi 55 (UK/Ireland) – 5-inch screen, Bluetooth, eco route, lifetime traffic alerts	£89.00
Nüvi 55 (Western Europe) – 5-inch screen, Bluetooth, eco route	£99.00
Digital radio	
Fully integrated digital radio	£195.00
Multimedia	
Parrot Asteroid Mini	£399.00
Parrot Asteroid Tablet	£499.00
TomTom semi-integrated sat nav	
TomTom Start 25	£249.00
TomTom Via Business	£279.00
TomTom GO Business	£349.00
TomTom GO 5000	£379.00
Sat Nav updates¹	
Please consult your retailer for latest map updates or visit www.vauxhall.co.uk/accessories .	

1 = For use with optional factory-fit satellite navigation systems.

	Total (inc. VAT)
CHILD SEATS²	
BABY-SAFE ³ – 0-13kg/birth to 15 months	£119.00
– ISOFIX base	£208.00
DUO ISOFIX ³ – 9-18kg/9 months to 4 years	
with top tether kit	£317.00
KID ³ – 15-36kg or 4 to 12 years	£144.00
2 = Restrictions apply to the use of child seats, please consult your Vauxhall retailer.	
3 = Without transponder.	
SAFETY	
Privacy shades – rear side windows	from £54.00
Privacy shades – tailgate window	£101.00
Parking sensors	
– four fully flush front bumper mounted sensors	
– unpainted	£320.00
– painted	£350.00
– four fully flush rear bumper mounted sensors	
– unpainted	£300.00
– painted	£330.00
Safety Pack – first aid kit, warning triangle, hi-visibility vest, Vauxhall bag	
First aid kit	£13.00
Warning triangle	£16.00
Hi-visibility vest	£8.00
Fire extinguisher – 2kg	£34.00
Temporary tyre inflation kit	£126.00
Tyre sealant	£58.00
SECURITY	
Locking wheel bolts – set of four	£43.00
Steering wheel security bar	£77.00

	Total (inc. VAT)
PRACTICAL	
Premium spare bulb kit ⁴	from £23.00
Jump leads	
– petrol engines (16mm standard)	£42.00
– petrol/diesel engines (25mm heavy duty)	£75.00
Fuel can – 10 litre	£24.00
Stretch tow rope – 2 tonne	£31.00
Smoker pack	£39.00
4 = Excludes xenon headlight bulb for models with Adaptive Forward Lighting (AFL)	
PROTECTION	
Rubber floor mats – set of four	£69.00
Velour floor mats – set of four (black or brown)	£74.00
Pedal covers – alloy effect	from £126.00
Cargo liner – all models	from £65.00
Vertical load restraint net	
– Sports Tourer	£233.00
Dog guard – Sports Tourer	£137.00
FlexOrganiser® System – Sports Tourer	
– side net pocket	£33.00
– fixing adaptor	£8.00
– side rail hook (each)	£3.00
– fixing strap	£32.00
– fold-flat storage box	£24.00
Mudflaps front and rear ⁵	£100.00
5 = Not available with certain exterior styling accessories.	

	Total (inc. VAT)
TOURING	
T-track base carrier	from £163.00
Thule bicycle carrier ⁶	from £70.00
Thule ski carrier ⁶	from £105.00
Thule surfboard carrier ⁶	from £79.00
Thule roof boxes⁶	
– Ocean 80 hard roof box (340 litres)	£215.00
– Pacific 200 hard roof box (460 litres)	from £320.00
– Ranger 90 soft roof box (340 litres)	£260.00
More available, please consult your retailer for details.	
Fixed tow bar	
– 13-pin electrics	from £555.00
Detachable tow bar	
– 12N electrics	£710.00
– 13-pin electrics	from £715.00
Tow bar carrier system	
Thule tow bar Euroride 940	
two-bicycle carrier	£226.00
Thule tow bar Euroway	
two-bicycle carrier	£345.00
Thule tow bar Euroway	
three-bicycle carrier	£430.00
Thule tow bar extension for fourth bicycle	£109.00
6 = Must be used in conjunction with a base carrier.	
VXR EXTERIOR STYLING	
VXR rear lip/roof spoiler	
– hatchback/saloon	£412.00

Please note:

Prices shown are a fully fitted and painted, where applicable and include VAT. Please check with your local Vauxhall retailer for details. It is advisable to ensure your insurance policy is adequate to cover additional fitted accessories. Prices correct at time of publication.

INSIGNIA ADDITIONAL INFORMATION

ON-THE-ROAD PRICES

To eliminate uncertainty about hidden costs when buying a new car, Vauxhall publishes on-the-road recommended retail prices (RRP) and these are shown in the pricing tables within this price guide. These prices include the recommended cost of number plates and delivery to a Vauxhall retailer of £700.00 (including £116.67 VAT), 12 months' Government Vehicle Excise Duty (see opposite for details) and the DVLA new vehicle first registration fee of £55.00*.

Please note: The on-the-road recommended retail price (RRP) does not include fuel supplied by the retailer, motor insurance or any other goods or services supplied by agreement between the retailer and the customer.

PRICE PROTECTION

Order a new Vauxhall for build in the current model year (as confirmed by your retailer) for delivery no more than three months in advance and the price you are quoted is the price you pay. This is irrespective of any subsequent price rises between placing your order and delivery of your new car, but you must take delivery as soon as the car is available. General Motors UK Limited is not liable for price adjustments caused by Government changes in the rate of VAT (currently 20%), Vehicle Excise Duty, DVLA new vehicle first registration fee or by any other applicable legislation or regulations.

VEHICLE EXCISE DUTY

The amount of Vehicle Excise Duty (road fund licence) payable on new cars varies depending on the level of carbon dioxide (CO₂) emissions produced by the vehicle. CO₂ emissions are measured in grammes (g) per kilometre (km) travelled and divided into 13 charging bands shown in the table below.

From 1 April 2010 the Government introduced a new 'first year rate' of Vehicle Excise Duty payable on all new cars. In subsequent years the amount of Vehicle Excise Duty payable will revert to the standard rate.

Vehicle Excise Duty*

	CO ₂ emissions (g/km)	First year rate	Standard rate
Band A	up to 100	£0.00	£0.00
Band B	101-110	£0.00	£20.00
Band C	111-120	£0.00	£30.00
Band D	121-130	£0.00	£110.00
Band E	131-140	£130.00	£130.00
Band F	141-150	£145.00	£145.00
Band G	151-165	£180.00	£180.00
Band H	166-175	£295.00	£205.00
Band I	176-185	£350.00	£225.00
Band J	186-200	£490.00	£265.00
Band K	201-225	£640.00	£290.00
Band L	226-255	£870.00	£490.00
Band M	over 255	£1100.00	£505.00

* = Correct at time of issue.

E10 FUEL

E10 fuel is cleared for use in all petrol-engined Vauxhall vehicles excluding models with the 2.2 litre petrol engine (code Z22YH) used in Vectra, Signum and Zafira models. Owners of these vehicles should continue to use regular unleaded or premium unleaded petrol.

PROTECTING THE ENVIRONMENT

Vauxhall's commitment to the environment is demonstrated by our products' many environmental awards. For even more information on Vauxhall's efforts to achieve an environmentally sustainable future, see www.vauxhall.co.uk/recycling

VAUXHALL ASSISTANCE

Vauxhall Assistance is provided automatically with every new Vauxhall for 12 months from first registration and covers everything from accident assistance, roadside recovery and 'at home' service to flat tyres. With Vauxhall Assistance help is literally just a free** phone call away, 24 hours a day, 365 days a year!

** = Mobile phone users will be charged at their standard tariff.

VAUXHALL LEASING

As Vauxhall's own contract hire and fleet management operation, Vauxhall Leasing provides a one-stop-shop for competitive car and van leasing solutions – for business users and private individuals. Working with the Vauxhall retailer network, we combine the support of a national contract with the convenience of a local contact.

For further information, please see your local Vauxhall retailer or call us on **0870 737 2557**. Alternatively, you can visit our website at www.vauxhall-leasing.co.uk

IN THE EVENT OF AN ACCIDENT...

Vauxhall Accident Support helps keep you mobile following an accident. Benefits include scene-of-accident advice, message service, assistance with claims and vehicle recovery. For further details call **0800 010 304**.

Alternatively, details can be found on our website at www.vauxhall.co.uk

VAUXHALL SERVICE PLAN

Vauxhall retailers offer a great service for owners of all Vauxhall cars. Value for money, regular offers and free check-ups, combined with the peace of mind that comes from using Vauxhall-trained technicians and genuine parts, help keep your car in peak condition at all times.

FOR MORE PRODUCT INFORMATION

For a brochure on any Vauxhall model (up to a maximum of three per caller) or location of your nearest Vauxhall retailer please call **0345 600 1500**. Alternatively, details can be found on our website at www.vauxhall.co.uk

VAUXHALL INSURANCE WITH ADDED REASSURANCE

Comprehensive cover – Summary of benefits*

- Competitive premiums
- Repairs by a Vauxhall-trained technician
- Genuine Vauxhall parts, guaranteed for three years when we repair your car within our Approved Repairer Network
- Free courtesy car as standard when using an Approved Repairer**
- 24 hour claims helpline
- Personal Accident benefit
- Cover for audio equipment
- Windscreen cover

Call for a quote on **0844 463 2670†**

*The benefits listed above are for comprehensive cover only. For details of Third Party, Fire and Theft cover, please call our sales team.
**Should your car need repairing following an accident we provide a courtesy car (subject to availability) for the duration of the repair. Only genuine Vauxhall parts are used. Terms and conditions apply.
†Calls may be recorded. Vauxhall Motor Insurance is underwritten by Ageas Insurance Limited.

Every effort has been made to ensure that the contents of this document were accurate and up-to-date at the time of publication – 2 July 2015 (Amended 10 July 2015). The invoice price, including delivery to retailer, factory-fitted options, accessories fitted by the retailer and number plates, is subject to VAT. The right is reserved to alter specifications and prices, and withdraw products from sale, without notice. Please note that Vauxhall retailers are not the agents of General Motors UK Limited t/a Vauxhall and are not authorised to bind General Motors UK Limited by any specific or implied undertaking or representation. It is advisable to ensure that your motor insurance policy provides adequate cover for additional fitted options and accessories. All rights reserved. No part of this publication may be reproduced in any form or by any means, without the prior written permission of General Motors UK Limited.

Base information prepared by Graymatter. General Motors UK Limited, Luton LU1 3YT www.vauxhall.co.uk

©2015 General Motors UK Limited



VAUXHALL