

New Astra

2010 Models Edition 2



ASTIRA



Contents

Dynamic handling	06	Engines and transmissions	22	VXR styling	44
Exterior styling	08	Environmental issues	24	Accessories	46
Interior styling	10	Features	26	Colours	48
Innovative technology	14	Infotainment	30	Trims	50
Safety	16	New Astra range	32	Equipment	52
Driving dynamics	20	Wheels	42	Technical data	58



Astra SRi

Introducing the all-new Astra from Vauxhall.

A bold new shape and a dynamic driving experience. Innovative technology and a premium feel, inside and out. Your all-new Astra. Sleek. Stylish. Dynamic.

This brochure covers new Astra Expression, ES, Exclusiv, SRi, SRi VX-Line, SE and Elite models only. Some of the models shown include options and accessories available at extra cost. And not all of the features described are available on every model. So please check in the Equipment section for further details. From time to time, we may also offer alternative new Astra models such as Special Editions, featured in their own separate literature or found on the Vauxhall website: www.vauxhall.co.uk



A real performer.

New Astra drives as dynamically as it looks. You're connected to the road with a new suspension set-up for seriously improved ride and agility. Add powerful, more efficient engines and the result is an altogether more exhilarating experience.

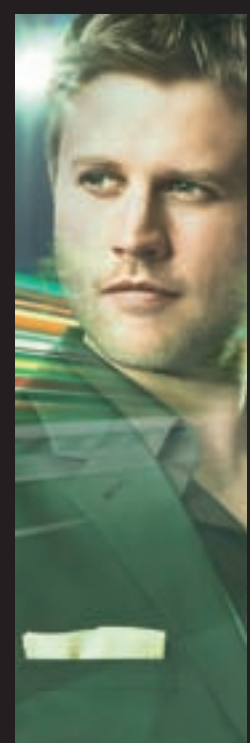

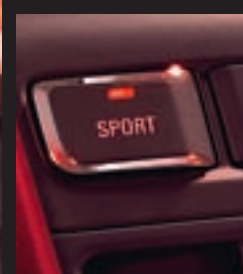
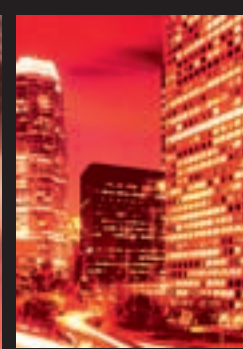

Steal the scene.

New Astra has a lean sculpted shape, a five-door silhouette, yet athletic coupé-inspired lines. And a sporty confident stance accentuated by signature lighting. New Astra – redefining traditional hatchback design inside and out.







Star quality comes from within.

The ethos of new Astra design continues inside. Not just flexible space and comfort for five, driver-orientated ergonomics, intelligent features and unique storage solutions. But superior quality and almost obsessive detailing that flows throughout the car.









Special effects in every scene.

When you're in touch with the latest technology, life just becomes more simple, safer and stress-free. New Astra can provide a different driving feel to match your mood. And intelligent headlights that change with the conditions.

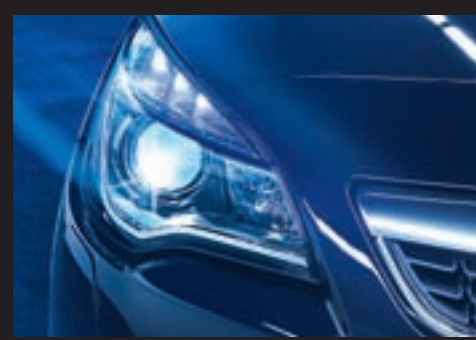



Intelligent Adaptive Forward Lighting (AFL). New Astra's intelligent AFL headlights change their pattern to suit the location and the weather. Sensing where you need the light most, they can even help you see around corners. And if something is coming the other way, they dip automatically. They can also be switched to 'right hand traffic' when travelling abroad.

LED daytime running light. Increases your visibility to other road users without increasing fuel consumption (unlike low beam).



Pedestrian area light (up to 20mph). Wider spread of light (an extra eight degrees left and right) illuminates potential hazards.



Town light (20-35mph). Wider and lower spread of light. Activated by vehicle speed together with street lighting.



Country road light (30-60mph). Wider spread and brighter light than normal low beam. 70 metre range without dazzle.



Motorway light (over 60mph). 140 metre range, higher and brighter than normal low beam, without dazzle.



Adverse weather light (up to 45mph). Wiper or rain sensor activated for better vision in bad weather conditions.



High beam with assist (any speed). Automatically switches from high to low beam as it detects oncoming or preceding vehicles.



Dynamic curve light (any speed). Activated by steering angle and speed, the headlights swivel up to 15 degrees into the curve.



Static cornering light (up to 25mph, also when reversing). Throws light 90 degrees left or right for enhanced lateral vision.



Investing in your safety. State-of-the-art in-car safety doesn't happen by accident. It happens by continuous investment in award-winning technology. Innovations like front, side and curtain airbags, front seatbelt pretensioners, pedal release system and active-safety front seat head restraints – all standard on every new Astra model – are aimed at helping to protect you in every type of impact situation. The front passenger's front and side airbags can be easily deactivated when carrying a child seat on the front passenger seat. And new Astra's advanced braking features together with the options of a sophisticated FlexRide chassis with Continuous Damping Control (CDC) and Adaptive Forward Lighting (AFL) technology play an equally important role in helping prevent accidents in the first place. It won't surprise you to learn that Vauxhall innovation is helping to keep your insurance premiums down with advanced security systems and smart new bumpers that minimise damage in low speed impacts. That same engineering innovation is also reducing the risk of injury to pedestrians should an impact occur.



Active-safety front seat head restraints – minimise the risk of whiplash injury and guard against other head and upper body injuries.

Front and rear parking distance sensors – sound a warning if they sense anything behind, or in front of, the vehicle when parking. Optional at extra cost.







Astra SRi

Even greater ride comfort, sharper steering response and exceptional agility were serious targets for the new Astra chassis. And our success is partly due to the new rear axle design with its clever Watt's link. Providing greater lateral control, improving the car's composure in corners, it delivers similar performance to more complex multi-link systems. In addition, all models feature Electronic Stability Programme-plus (ESP-plus) as standard. The optional FlexRide adaptive damping adds even more sophistication to the new Astra driving dynamic.



The optional FlexRide (Adaptive Stability Technology) system responds instantly to data collected from chassis and drive components. Continuous Damping Control, which adjusts the damper settings in real time, four-channel Anti-lock Braking System with electronic brakeforce distribution, traction control and Electronic Stability Programme (ESP) – they all communicate with each other continuously. FlexRide simply combines all the elements for the chosen driving mode.

When you select Sport mode, new Astra sharpens the speed-sensitive steering response, throttle input and automatic transmission (when fitted), and stiffens the dampers to ensure optimum road contact. On some models, the driver can select which functions switch into Sport mode. The instrument lighting also changes from white to red.

Select Tour mode and the system adjusts the damper settings to further enhance new Astra's ride comfort, making it ideal for long distance motorway journeys.

If neither Sport nor Tour modes are activated, the FlexRide system automatically defaults to Normal mode. The dampers permanently adapt to changing driving situations, providing more comfort than a conventional chassis, but with improved cornering behaviour and better steering response in changing traffic situations.

FlexRide is available as an extra-cost option on most models.



Sport or Tour? The touch of a button changes the whole driving dynamics to taut sporting excitement or relaxed long distance cruising.



Power and efficiency. New Astra balances lively performance with fuel efficiency and low, Euro 5 compliant emissions. And as you might expect, it's all down to innovative Vauxhall ECOTEC engine technology.

Three ECOTEC petrol engines – an all-new 1.4i 16v VVT available with 87PS and 100PS power outputs, and the 115PS 1.6i 16v VVT – feature 16 valves and the latest in Variable Valve Timing (VVT) with optimised swirl characteristics. And there are two turbocharged engines – an exciting all-new 140PS 1.4i 16v VVT and the proven 180PS 1.6i 16v.

On the diesel side, new Astra ECOTEC engine technology is equally impressive – and beneficial. All four engines share cutting-edge common rail multi-injection, variable geometry turbocharger and 16-valve technology. And your choice runs to three ecoFLEX units – a 1.3CDTi 16v (95PS) and two 1.7CDTi 16v versions (110PS and 125PS) – or our top-of-the-range 160PS 2.0CDTi 16v.

With CO₂ emissions of just 109g/km, power output of 95PS and 190Nm maximum torque available across a wide rev range, the new Astra 1.3CDTi 16v ecoFLEX models underline our commitment to making flexible performance available without compromises in sustainability, fuel savings and reductions in CO₂ emissions.

This is not achieved through engine development alone, of course. New Astra 1.3CDTi 16v ecoFLEX models also feature front and underbody aerodynamic fine tuning, optimised gear ratios and a 'shift-up' indicator.

Whichever new Astra model you choose, you can be sure of a precise, easy-shifting manual transmission – with six speeds on all turbo petrol models and all diesels except the 1.3CDTi 16v. An all-new automatic six-speed transmission, available on the 1.6i 16v VVT and 2.0CDTi engines, features Active Select® which allows you to take control of gear changes via a sequential shift.



eco FLEX

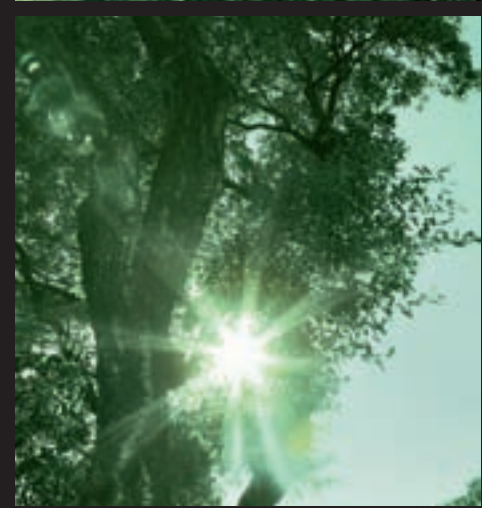
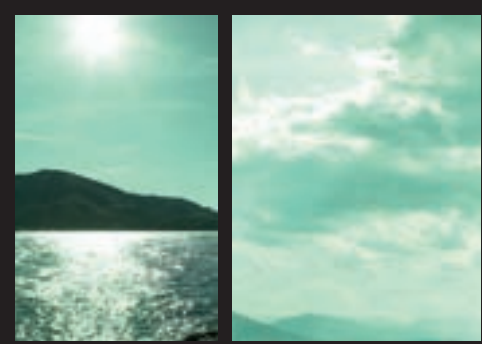



Always respecting our world.

We all share a responsibility to look after our world. That's why Vauxhall has been at the forefront of green automotive initiatives for many years. We are always looking to reduce vehicle CO₂ emissions, of course, and our ecoFLEX models like the new Astra 1.3CDTi 16v (95PS) have among the lowest vehicle CO₂ emissions in their class.

But our commitment to preserving the environment goes even further. We are working on even cleaner, alternative power sources, including zero-emission fuel cell technology, for example. We have dramatically reduced manufacturing emissions, and our new models use more recycled materials and more recyclable parts than ever before.

We also offer free and easily accessible, environmentally friendly, end-of-life vehicle disposal through our partners Autogreen Ltd. That way, we reduce our environmental impact in every phase of every vehicle's life cycle. Because your world is our world, too.





Everything has its place. And the latest generation Astra has a whole new attitude to practical, ingenious interior stowage. Door pockets with room for bottles, a driver's storage compartment, drinks holders, front and rear centre armrests with closed storage compartments – to name just a few examples – new Astra keeps everything within easy reach. With space for 351 litres of luggage – extendable to 1216 litres with the 60/40 split-folding rear seat – new Astra also ranks among the roomiest vehicles in its class. And with our Flex Floor system, allowing the load floor to be mounted level with the rear sill or to the folded rear seats, it's easy to load and unload too.



1

2

3

4

5

6

7

From the new Astra's driving seat, the world is an altogether calmer, more comfortable place. There's space, comfort and stowage for every passenger. New levels of interior style and quality combine with intuitive ergonomics that put you in total control. And the interior attention to detail borders on the obsessive. Special emphasis has gone into the design and engineering of new Astra's front seats, which now boast industry leading levels of adjustment. Their height can be raised by up to 65mm, while their fore-and-aft range extends to 280mm to ensure a better seating position for all drivers. Whichever way you look at it, new Astra is a very special space to sit.



Electronic Climate Control provides constant control of the interior atmosphere via an onscreen display, making the ideal comfort temperature easy to set for driver and front passenger. Standard on Elite, optional on all other models except Expression and ES.



Ergonomic sports seats.

New Astra's orthopaedic ergonomic sports front seats adjust to suit your posture – perfectly – with an improved tilt adjustment (driver's seat only) and electric lumbar support. They also feature superior side support and an extendable seat cushion. Standard on Elite models with perforated leather facings, and optional on all other models with Lace cloth trim (except Expression and ES), the driver's seat has won the coveted AGR* seal of approval for helping to prevent the in-car back pain and tension suffered by some car occupants.

*Aktion Gesunder Rücken e.V (AGR) is an independent panel of ergonomics experts and doctors based in Germany.

- 1 Active-safety head restraints
- 2 Seat back recliner
- 3 Seat height adjuster
- 4 Electrically adjustable lumbar support
- 5 Cushion tilt control
- 6 Adjustable seat cushion extension
- 7 Steering column adjustable for reach and rake



New Astra audio equipment covers the full spectrum from CD players with MP3 format and six-disc CD autochanger/ stereo radio to a CD-based satellite navigation unit with seven-inch colour monitor. A Digital Audio Broadcast (DAB) radio option is available on all three audio units offering a variety of advantages over traditional FM quality (see page 57).

The optional CD 500 satellite navigation/ CD player with MP3 format/stereo radio includes a navigation CD covering over 30 countries with a comprehensive travel guide. There's 1GB flash memory available for copying navigation data across from a map CD, while RDS Traffic Programme messages are automatically displayed and can be included in route planning at any time. It also has 20 watts per channel output, seven premium speakers – plus auxiliary-in and USB inputs conveniently placed in the centre console storage for MP3 player and memory stick functionality.

While the standard new Astra CD player with MP3 format/stereo radio (CD 400) features a single-disc CD player, the CDC 400 adds the extra convenience of a six-disc integral CD autochanger. Both units feature an auxiliary-in socket, RDS with Traffic Programme, 7-band graphic equaliser and 20 watts per channel output through seven speakers for exceptional audio performance. A USB connection is also available as an extra cost option.



Navigation made clearer. Located high in the driver's sight line, the CD 500 seven-inch colour monitor provides superb clarity. It is recessed to avoid visual interference from direct sunlight.



Infinity Premium Sound System. For the ultimate sound performance, the optional Infinity Premium Sound System features a Digital Sound Processor and a 7x45 watts per channel output amplifier to drive eight premium speakers, comprising one 8-inch subwoofer in the luggage compartment, two 6.5-inch front door-mounted subwoofers, two 6.5-inch rear door-mounted wide-band speakers, one front-mounted 3.5-inch medium-range speaker and two A-pillar mounted 1-inch tweeters. The result is superlative acoustic response in all driving conditions.

Mobile phone systems. Available as an extra cost option, new Astra can be pre-equipped for hands-free operation of most mobile phones using wireless Bluetooth® technology. There are two systems available, both of which allow all key functions to be operated from either the steering wheel, the audio unit or via voice control.



Setting the scene.

The new Astra five-door hatchback is available in a choice of seven different trim levels – Expression, ES, Exclusiv, SRi, SRi VX-Line*, SE and Elite – each one a different and special interpretation of the new Astra character.

**Anticipated availability Summer 2010.*







Expression and ES

- Electronic Stability Programme (ESP)
- Driver's and front passenger's airbags
- Front seat side-impact airbags
- Full-size curtain airbags
- Active-safety front seat head restraints
- Daytime running lights
- 16-inch steel wheels with flush covers (steel space-saver spare wheel)
- Air conditioning
- CD 400 CD player with MP3 format/ stereo radio
- Auxiliary-in socket
- Driver's seat height adjuster
- 60/40 split-folding rear seat back
- Electrically operated front windows
- Electrically adjustable/heated door mirrors
- Remote control central deadlocking
- Steering column adjustable for reach and rake
- Two-coat metallic/pearlescent paint available at extra cost on ES models

Engine availability	Insurance groups (ABI)
1.4i 16v VVT (87PS)*	9E
1.4i 16v VVT (100PS)**	9E
1.6i 16v VVT**	12E
1.6i 16v VVT automatic**	12E
1.3CDTi 16v (95PS) ecoFLEX**	9E
1.7CDTi 16v (110PS) ecoFLEX**	13E

*Expression models only.
 **ES models only. Insurance group rating provisional at time of going to press.

Please note: Insurance groups relate to the 50 group rating.

Exclusiv

Additional features over and above ES models:

- Cruise control
- Steering wheel mounted audio controls
- Chrome-bezelled steering wheel
- Ambient light in centre console and roof
- Covered storage container in centre console
- Front seat back storage pockets

Engine availability

Insurance groups (ABI)

1.4i 16v VVT (87PS)	9E
1.4i 16v VVT (100PS)	9E
1.6i 16v VVT	12E
1.6i 16v VVT automatic	12E
1.4i 16v VVT Turbo	17E
1.3CDTi 16v (95PS) ecoFLEX	9E
1.7CDTi 16v (110PS) ecoFLEX	13E

Please note: Insurance groups relate to the 50 group rating.

Model illustrated features CDC 400 audio unit and USB connectivity, optional at extra cost.



Exclusiv

SRI

Additional features over and above

Exclusiv models:

- 17-inch 5-spoke alloy wheels (steel space-saver spare wheel)
- Lowered and uprated sports suspension*
- Three-spoke leather-covered sports steering wheel
- Leather-covered gear knob (manual only)
- Electric parking brake
- Sports front seats
- Dark-style headlights
- Front fog lights
- Multi-function trip computer
- Remote control alarm system**
- Chrome-effect exterior side window surround
- Front centre armrest
- Flex Floor luggage compartment
- Ambient lighting in front doors
- Illuminated vanity mirrors
- Front door sill covers

Engine availability**Insurance groups (ABI)**

1.4i 16v VVT (100PS)	9E
1.6i 16v VVT	12E
1.6i 16v VVT automatic	12E
1.4i 16v VVT Turbo	17E
1.6i 16v Turbo	24E
1.3CDTi 16v (95PS) ecoFLEX	9E
1.7CDTi 16v (110PS) ecoFLEX	15E
1.7CDTi 16v (125PS) ecoFLEX	15E
2.0CDTi 16v	20E
2.0CDTi 16v automatic	20E

*Not available on 1.4i 16v VVT (100PS) and 1.3CDTi 16v ecoFLEX models.

**Optional at extra cost on 1.4i 16v VVT (100PS) and 1.3CDTi 16v ecoFLEX models.

Please note: Insurance groups relate to the 50 group rating.

Model illustrated features FlexRide, Sight and Light Pack, front and rear parking distance sensors, CD 500 satellite navigation system and electronic climate control, optional at extra cost. Please note: SRI and SRI VX-Line centre console decor moulding is all Liquid Palladium and will not feature Piano Black inserts.



SRI VX-Line[†]

Additional features over and above SRI models:

- 18-inch 5-twin-spoke alloy wheels (steel space-saver spare wheel)
- VXR Styling Pack comprising:
 - Front lower spoiler
 - Rear lower skirt
 - Rear roof spoiler
 - Side sills



Engine availability

1.6i 16v VVT
 1.6i 16v VVT automatic
 1.4i 16v VVT Turbo
 1.6i 16v Turbo
 1.7CDTi 16v (110PS)
 1.7CDTi 16v (125PS)
 2.0CDTi 16v
 2.0CDTi 16v automatic

Insurance groups (ABI)

12E
 12E
 17E
 24E
 15E
 15E
 20E
 20E

[†]Anticipated availability Summer 2010.

Please note: Insurance groups relate to the 50 group rating.

The visible stainless steel tailpipe (illustrated above) is standard equipment on 1.4i 16v VVT Turbo, 1.6i 16v Turbo and 2.0CDTi models only.

SE

Additional features over and above

Exclusiv models:

- 17-inch 10-spoke alloy wheels (steel space-saver spare wheel)
- Three-spoke leather-covered sports steering wheel
- Electric parking brake
- Ribbon cloth/Morrocana trim
- Rain-sensitive windscreen wipers
- Automatic lighting control with tunnel detection
- Electro-chromatic anti-dazzle rear-view mirror
- Front fog lights
- Multi-function trip computer
- Remote control alarm system
- Chrome-effect exterior side window surround
- Electrically operated rear windows
- Front centre armrest
- Flex Floor luggage compartment
- Ambient lighting in front doors
- Illuminated vanity mirrors
- Front door sill covers

Engine availability

Insurance groups (ABI)

1.6i 16v VVT	12E
1.6i 16v VVT automatic	12E
1.4i 16v VVT Turbo	17E
1.6i 16v Turbo	24E
1.3CDTi 16v (95PS) ecoFLEX	9E
1.7CDTi 16v (110PS) ecoFLEX	15E
1.7CDTi 16v (125PS) ecoFLEX	15E
2.0CDTi 16v	20E
2.0CDTi 16v automatic	20E

Please note: Insurance groups relate to the 50 group rating.

Model illustrated features front and rear parking distance sensors, electrically foldable door mirrors, CD 500 satellite navigation system, electronic climate control and automatic transmission, optional at extra cost.









Elite

Additional features over and above SE models:

- Dual-zone electronic climate control with humidity sensor
- Perforated leather seat facings
- Heated front seats
- Ergonomic sports front seats with extendable cushions and electric lumbar adjustment
- Fold-down rear seat centre armrest with load-through facility
- Electrically foldable door mirrors

Engine availability

Insurance groups (ABI)

1.6i 16v VVT	12E
1.6i 16v VVT automatic	12E
1.4i 16v VVT Turbo	18E
1.7CDTi 16v (125PS) ecoFLEX	15E
2.0CDTi 16v	20E
2.0CDTi 16v automatic	20E

Please note: Insurance groups relate to the 50 group rating.

Model illustrated features FlexRide, front and rear parking distance sensors and CD 500 satellite navigation system, optional at extra cost.

Standard wheels:

Expression/ES



16-inch steel wheel with flush cover.

Exclusiv



16-inch steel wheel with flush cover.

SRI



17-inch alloy wheel.

SRI VX-Line



18-inch alloy wheel.

SE/Elite



17-inch alloy wheel.

Optional wheels:

Exclusiv



17-inch Structure wheel (no cost option).

SRI



18-inch alloy wheel (extra cost option).*

SRI VX-Line



19-inch alloy wheel (extra cost option).

SE/Elite



18-inch alloy wheel (extra cost option). †**

Exclusiv



17-inch alloy wheel (extra cost option).

SRI



19-inch alloy wheel (extra cost option).*

All models feature a steel space-saver spare wheel.

*Not available on 1.4i 16v VVT (100PS) or 1.3CDTi 16v models.

**Not available on 1.3CDTi 16v SE models.

†Adds lowered and uprated suspension unless FlexRide is also specified.





Astra SRi



VXR styling products allow you to connect with the performance and excitement at the heart of the VXR brand. Taking that same ethos as our brief we have created a definitive line-up of VXR styling products that will add a degree of individuality to any new Astra.



VXR Styling Pack. This pack is fitted as standard to SRi VX-Line* models and is available as a factory-fit* option for most models or as separate accessories fitted by your Vauxhall retailer.

Styling products include:

- Front lower spoiler
- Rear lower skirt
- Rear roof spoiler
- Side sills

Models illustrated feature the VXR Styling Pack, 19-inch five-spoke alloy wheels, Premium Forward Lighting Pack, Sight and Light Pack, CD 500 satellite navigation system and metallic/pearlescent paint, optional at extra cost.

**Anticipated availability Summer 2010.*

Whatever you're into, there's certain to be a Vauxhall accessory with your name on it, all fitted by trained Vauxhall professionals. We've only featured a small selection of what is available here, so please check with your Vauxhall retailer for new Astra accessory availability information or check out our website at www.vauxhall-accessories.com



Both rubber and velour floor mats (illustrated) are available for your new Astra. Both styles sport an Astra logo and have unique fixing points which help keep them firmly in place.



Privacy shades – designed to provide shade from the sun when required. The windows can be lowered with the shades in place. Available for the rear side windows and tailgate glass, they are also removable.



A range of Thule roof boxes are available to fit to the aluminium base carrier system, each one lockable and easy to fit.



The rear-facing Baby-Safe (up to 13kg) and KID (15-36kg) seats are fixed with a standard lap and diagonal seatbelt. The DUO ISOFIX (9-18kg) can also be attached using the ISOFIX child seat restraint fittings (complete with Top Tether), standard on the outer rear seats of new Astra models.

FURTHER ACCESSORIES INCLUDE:

- Bicycle carriers
- Mudflaps
- Fixed or detachable tow bars with 7- or 13-pin connection
- USB multimedia connection
- Smoker Pack
- Front passenger seat net
- Rear bumper protection film
- Load-restraining net
- Alloy wheels
- Safety Pack
- Door sill covers
- Rear parking distance sensors
- VXR styling accessories

Main vehicle illustrated features accessory base carrier with surfboard attachment, privacy shades and 19-inch five-spoke alloy wheels available at extra cost.

Please note: fitting larger diameter wheels than standard will require the fitting of new tyres at extra cost. Two-coat metallic paint is also an extra-cost option.

Irmscher

Styling

Developed in conjunction with auto design specialists Irmscher International, Astra styling accessories perfectly complement the vehicle's lines, as well as being manufactured to the same exacting standards as the car itself.



Create a distinctive look for your new Astra with the cross hatch front grille from Irmscher. Featuring an aluminium upper strip with a laser-etched 'Irmscher' logo it adds a touch of individuality.



For individual looks and a sportier exhaust note too, this sports silencer with dual branched, split oval design chrome-plated tailpipes is the perfect choice for your new Astra. The rear bumper sports insert (also illustrated) is available separately.





With its sculpted shape and athletic lines, new Astra is the perfect blank canvas for our carefully selected range of contemporary exterior colours – each one reflecting new Astra's premium style. So you're sure to find one that perfectly complements your own taste, lifestyle and personality.



Olympic White – Solid

Available on all models.



Power Red – Solid (two-coat)

Available on all models.



Technical Grey – Metallic*

Not available on Expression models.



Sovereign Silver – Metallic*

Not available on Expression models.



Metro Blue – Metallic*

Not available on Expression models.



Panacotta – Pearlescent*

Not available on Expression models.



Silver Lake – Metallic*

Not available on Expression models.



Black Sapphire – Pearlescent*

Not available on Expression models.



Waterworld – Pearlescent*

Not available on Expression models.



Iceberg – Pearlescent*

Not available on Expression models.



Myth Green – Pearlescent*

Not available on Expression models.

*Optional at extra cost.

Due to the limitations of the printing process the colours reproduced may vary slightly from the actual paint colour. As a result, they should be used as a guide only. Your Vauxhall retailer has a comprehensive display of our paint samples. Vehicle illustrated is a non-specific model.



Cordoba cloth

Standard on: Expression/ES models.



Scene cloth

Standard on: Exclusiv models.



Ribbon cloth/Morrocana

Standard on: SE models.



Lace cloth – sport seat

Standard on: SRi/SRi VX-Line models.



Lace cloth – ergonomic sport seat

Optional at extra cost on: Exclusiv/SE/SRi/SRi VX-Line models.

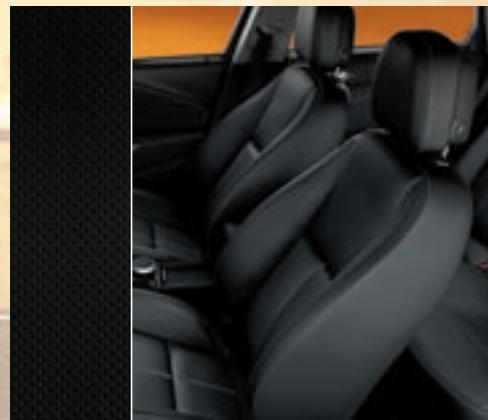

Leather – ergonomic sport seat

Standard on: Elite models. Optional at extra cost on SRi/SRi VX-Line models as part of Leather Pack.

New Astra's interior trims, available in comfortable, hardwearing fabric or perforated leather, have been carefully selected for their premium feel and appearance. They complement our exterior paint finishes and the textures, style and colour of the fascia, door panels and other interior detailing, and reflect the individual status of each trim level.

Due to the limitations of the printing process the colours reproduced may vary slightly from the actual trim material. As a result they should be used as a guide only. Your Vauxhall retailer has a comprehensive display of our trim swatches.



Contents

Equipment

Safety and Security	52
Heating and ventilation Facia, instruments and controls Interior lighting	53
Seating and upholstery Additional interior features	54
Mechanical Exterior styling and protection Exterior lighting	55
Exterior and convenience features Option packs	56
Audio, communication and navigation	57
Technical data	
Petrol/diesel engines	58
Performance, fuel economy and emissions	59
Vauxhall Assistance and warranties, optional transmission, suspension, steering, brakes, body, fuel tank capacity and wheels and tyres	60
Exterior dimensions Weights and towing data Luggage capacities	61
Features explained	62

Personalise your New Astra

The new Astra has a number of features which can be activated or deactivated to suit the driver's preference, and some can be memorised for each individual vehicle key. Depending on equipment level, whenever the key is removed from the ignition lock the following settings can be automatically remembered by the key - lighting, infotainment system, central locking system, sport mode and comfort settings. Please refer to the handbook for further details.

Safety

Standard features

Airbags: • Driver's airbag • Front passenger's airbag • Front seat side-impact airbags • Full-size curtain airbags • Deactivation switch for front passenger's front and side-impact airbags – Ensures front passenger airbags do not inflate when a child seat is fitted to the front passenger's seat

Seating: • Active-safety front seat head restraints • Height-adjustable front and outer rear seat head restraints • Five lap and diagonal inertia-reel seatbelts (height-adjustable front) • Front body-lock diagonal seatbelt pretensioner system – Tightens the seatbelt during the early stages of a frontal impact • Drivers and front passenger's lap belt pretensioner system • Front seatbelt force limiters – Reduces potential upper body injuries during a frontal impact • Anti-submarining ramps in front seats – Help prevent occupants sliding underneath the lap belt during a collision • ISOFIX child seat restraint system for outer rear seats incorporating top tether (does not include child seat) – Secures specially designed ISOFIX child safety seats to the vehicle itself, virtually eliminating the dangers that can result from improper installation

Electronic: • Electronic Stability Programme-plus (ESP-plus) – Reduces the possibility of losing control of the vehicle – see **D2** on page 62 • Anti-lock Braking System (ABS) • Electronic Brakeforce Distribution (EBD) • Cornering Brake Control (CBC) – see **D1** on page 62 • Hydraulic Brake Fade Assist – Automatically raises braking pressure to compensate for brake fade under repeated applications of heavy braking • Emergency Brake Assist – Increases brake force applied in emergency braking situations • Straight Line Stability control • Traction control • Adaptive brake lights – If the driver brakes hard enough to activate the ABS function the brake lights flash on and off at a frequency of four times per second, warning following vehicles that heavy braking is in progress

Body: • Energy-absorbing steering column • Pedal release system – Reduces potential injury to the driver's legs and feet during a severe frontal impact • Laminated windscreen • Side-impact protection beams • Reinforced passenger safety cell • Deformation zones front and rear • Burst-proof door locks and anti-jam door design

Pedestrian: • Multi-pivot bonnet hinges – Allows the bonnet to move downwards cushioning any impact • Collapsible windscreen wiper system – Reduces the risk of head injury • Low density foam near front bumper crossmember – Reduces lower leg injuries • Plastic lower front bumper stiffener – Reduces knee injuries

Additional features

	Exp.	ES	Exclusiv	SRi	SRi VX-Line	SE	Elite
Height-adjustable centre rear seat head restraint			○ ¹	○ ¹	○ ¹	○ ¹	●
Tyre pressure monitoring system – see D4 on page 62			○	○	○	○	○

Security

Standard features • Remote control central deadlocking (doors, tailgate, fuel filler flap) • Visible Vehicle Identification Number (VIN) plate • 'Key left in ignition' audible warning • Freewheeling door locks • Electronic engine deadlock immobiliser • Electronic theft protection for audio equipment • Locking wheel nuts for alloy wheels (where fitted) • Driver's internal central locking switch • Door-to-door illumination – Keeps the headlights and rear lights illuminated for 30 seconds after exiting the car

Additional feature

	Exp.	ES	Exclusiv	SRi	SRi VX-Line	SE	Elite
Remote control ultrasonic security alarm system		○	○	● ²	●	●	●

Heating and ventilation

Standard features • Air blend heater with six-speed fan • Side window demist vents and adjustable face-level air vents
• Interior pollen filter • Rear passenger compartment heating outlets

Additional features

	Exp.	ES	Exclusiv	SRi	SRi VX-Line	SE	Elite
Air conditioning with air recirculation	●	●	●	●	●	●	
Dual-zone Electronic Climate Control (ECC) incorporating air conditioning with air quality and humidity sensors			○	○	○	○	●

Facia, instruments and controls

Standard features • Rev counter • Multi-function display showing time, date, audio information and outside air temperature (with ice warning function) • Digital clock with automatic RDS time adjustment • Steering column adjustable for reach and rake
• Electronic odometer and trip odometer • Instrument panel light dimmer • Handbrake-on/low brake fluid level and low fuel level warning lights • Service interval monitor • Seatbelt unfastened warning lights (front seats only)

Additional features

	Exp.	ES	Exclusiv	SRi	SRi VX-Line	SE	Elite
Electric parking brake				●	●	●	●
Three-spoke steering wheel	●	●					
Three-spoke chrome-bezelled steering wheel			●				
Three-spoke leather-covered sports steering wheel (part perforated leather on SRi models)				●	●	●	●
Leather-covered gear knob (manual models only)				●	●	●	●
Black instruments with chrome edging	●	●	●				
Translucent instruments with chrome edging				●	●	●	●
Multi-function trip computer				●	●	●	●
Cruise control			●	●	●	●	●

Interior lighting

Standard features • Fade up/fade down courtesy lights operated by front and rear door switches • Illuminated glovebox and luggage area • Map reading lights integral with front courtesy light

Additional features

	Exp.	ES	Exclusiv	SRi	SRi VX-Line	SE	Elite
Two rear reading lights				●	●	●	●
Overhead and centre console surround ambient lighting			●	●	●	●	●
Ambient lighting in front doors				●	●	●	●

● = Standard equipment. ○ = Optional at extra cost. Exp. = Expression.

1 = Fitted in conjunction with ergonomic sports front seats. Not available separately. Also available as part of the optional Interior Versatility Pack. 2 = Optional at extra cost on 1.4i 16v VWT (100PS) and 1.3CDTi 16v models.



Electronic Stability Programme-plus.



Dual-zone Electronic Climate Control (ECC).



Cruise control.



Front centre armrest with storage facility.



Front passenger's underseat storage facility.



Electro-chromatic anti-dazzle rear-view mirror.

Seating and upholstery

Standard features • Driver's and front passenger's seats with reach and recline adjustment • Driver's seat height adjuster
• 60/40 split-folding rear seat back

Additional features	Exp.	ES	Exclusiv	SRI	SRI VX-Line	SE	Elite
Cordoba cloth seat trim	●	●					
Scene cloth seat trim			●				
Ribbon cloth seat trim with Morrocana-trimmed side bolsters						●	
Lace cloth seat trim			○ ³	●	●	○ ³	
Perforated leather seat facings (includes heated front seats with variable temperature settings)				□	□		●
Front passenger's seat height adjuster				□	□		●
Sports front seats				●	●		
Ergonomic sports front seats with extendable seat cushions, height adjustment, four-way electrical lumbar adjustment and driver's seat tilt adjustment			○ ^{4.5}	○ ⁵	○ ⁵	○ ^{4.5}	●
Front centre armrest with storage facility				●	●	●	●
Front passenger's underseat storage facility			□	□	□	□	
Storage pockets on front seat backs			●	●	●	●	●
Fold-down rear seat centre armrest with load-through facility			○ ¹	○ ¹	○ ¹	○ ¹	●

Additional interior features

Standard features • 12-volt auxiliary power socket within front centre console • Chrome-effect internal door handles • Storage box on driver's side lower facia • Front and rear door pockets • Fully carpeted luggage area • Load restraint lashing eyes
• Luggage compartment cover • Drinks holder between front seats • Glovebox divider

Additional features	Exp.	ES	Exclusiv	SRI	SRI VX-Line	SE	Elite
Dark pearl-effect centre console and door inserts	●	●					
Silver dust-effect centre console and door inserts			●				
Dark matrix centre console and door inserts						●	●
Liquid palladium-effect centre console and door inserts				●	●		
Driver's sunglasses holder				●	●	●	●
Twin sunvisors incorporating illuminated driver's and front passenger's vanity mirrors with covers				●	●	●	●
Covered storage container in centre console			●	●	●	●	●
Central storage facility with twin covered drinks holders				●	●	●	●
Electro-chromatic anti-dazzle rear-view mirror – see D3 on page 62				□	□	●	●
12-volt auxiliary power socket located in rear centre console				●	●	●	●
Flex Floor luggage compartment		○	○	●	●	●	●

Mechanical

Standard features • Power-assisted steering • Lightweight MacPherson strut front suspension • Semi-independent rear suspension with Watt's link and gas-pressure dampers

Additional features	Exp.	ES	Exclusiv	SRI	SRI VX-Line	SE	Elite
Five-speed manual gearbox (1.4i 16v VVT (87PS)/1.4i 16v VVT (100PS)/1.6i 16v VVT/1.3CDTi 16v)	●	●	●	●	●	●	●
Six-speed manual gearbox (1.4i 16v VVT Turbo/1.6i 16v Turbo/1.7CDTi 16v (110PS)/1.7CDTi 16v (125PS)/2.0CDTi 16v)		●	●	●	●	●	●
Six-speed automatic transmission (1.6i 16v VVT/2.0CDTi 16v)		○	○	○	○	○	○
Lowered and uprated sports suspension				● ⁶	●		
FlexRide adaptive chassis control system with Continuous Damper Control (CDC) – see D6 and D7 on page 63				○ ^{6,7}	○ ⁷	○ ⁸	○



Six-speed automatic transmission.

Exterior styling and protection

Standard features • Body-colour door handles • Body-colour door mirrors • Chrome-effect upper grille surround • Black trim on door pillars

Additional features	Exp.	ES	Exclusiv	SRI	SRI VX-Line	SE	Elite
Chrome-effect front door sill covers				●	●	●	●
Chrome-effect side window mouldings				●	●	●	●
Body-colour front lower spoiler, side sills, rear lower skirt and rear roof spoiler (anticipated availability Summer 2010)			□ ⁹	□ ⁶	●	□ ⁹	□
Visible stainless steel exhaust tailpipe (1.4i 16v VVT Turbo/1.6i 16v Turbo/2.0CDTi 16v only)			●	●	●	●	●



Front fog light.

Exterior lighting

Standard features • Lights-on audible warning • LED centre brake light • Reversing light, rear fog light, hazard warning lights, side repeat indicators • Ellipsoid headlights • Electric headlight beam levelling • Daytime running lights

Additional features	Exp.	ES	Exclusiv	SRI	SRI VX-Line	SE	Elite
Chrome-effect headlights	●	●	●			●	●
Dark-style headlights				●	●		
Intelligent Adaptive Forward Lighting (AFL) incorporating dark-style bi-xenon headlights with dynamic beam levelling, LED daytime running lights and high-pressure headlight washers				□ ¹⁰	□ ¹⁰	□	□
Dark-style tail lights				●	●	●	●
Front fog lights				●	●	●	●
Automatic lighting control with tunnel detection				□	□	●	●



High-pressure headlight washers.

● = Standard equipment. ○ = Optional at extra cost. □ = Only available as part of an extra-cost option pack (see page 56 for details). Exp. = Expression.

1 = Fitted in conjunction with ergonomic sports front seats. Not available separately. Also available as part of the optional Interior Versatility Pack. 3 = Fitted in conjunction with ergonomic sports front seats. Not available separately. 4 = Changes seat trim to Lace cloth. 5 = Not available in conjunction with Interior Versatility Pack. 6 = Not available on 1.4i 16v VVT (100PS) or 1.3CDTi 16v models. 7 = Deletes lowered and uprated sports suspension. 8 = Not available on 1.3CDTi 16v models. 9 = Not available on 1.4i 16v VVT (87PS and 100PS) or 1.3CDTi 16v models. 10 = Only available in conjunction with Sight and Light Pack.



Folding key.



Electrically operated front and rear windows.



Front and rear parking distance sensors.

Exterior and convenience features

Standard features • Electrically operated front windows with safety autoreverse and one-touch facility • Twin electrically adjustable/heated door mirrors (wide angle on driver's side) • Tinted glass • Heated rear window with automatic timed cut-off • Intermittent rear window wash/wipe • Windscreen wipers with variable intermittent facility and flick-wipe • Twin-jet windscreen washer nozzles • Gas-assisted tailgate struts • Folding key

Additional features	Exp.	ES	Exclusiv	SRi	SRi VX-Line	SE	Elite
Hill Start Assist (HSA) – see D5 on page 62				●	●	●	●
Manually foldable door mirrors	●	●	●	●	●	●	
Electrically foldable door mirrors			○	○	○	○	●
Electrically operated rear windows with safety autoreverse and one-touch facility						●	●
Rain-sensitive windscreen wipers				□	□	●	●
Two-coat metallic or pearlescent paint		○	○	○	○	○	○
Front and rear parking distance sensors			○	○	○	○	○
Two-tone horn				●	●	●	●

Option packs

	Exp.	ES	Exclusiv	SRi	SRi VX-Line	SE	Elite
Sight and Light Pack • Automatic lighting control with tunnel detection • Rain-sensitive windscreen wipers • Electro-chromatic anti-dazzle rear-view mirror				○	○	●	●
Leather Pack • Perforated leather seat facings • Electrically heated front seats • Ergonomic sports front seats • Front passenger's seat height adjuster				○	○		●
Premium Forward Lighting Pack • Intelligent Adaptive Forward Lighting (AFL) incorporating dark-style bi-xenon headlights • LED daytime running lights • High beam assist • High-pressure headlight washers				○ ¹⁰	○ ¹⁰	○	○
Interior Versatility Pack¹¹ • Fold-out rear seat centre armrest with drinks holders and load-through facility • Front passenger's underseat storage facility • Height-adjustable centre rear seat head restraint			○	○	○	○	
VXR Styling Pack (anticipated availability Summer 2010) • Body-colour front lower spoiler, side sills, rear lower skirt and rear roof spoiler			○ ⁹	○ ⁶	●	○ ⁸	○
Towing Pack • Detachable tow bar • Trailer stability programme		○	○ ¹²	○	○	○	○

● = Standard equipment. ○ = Optional at extra cost. □ = Only available as part of an extra-cost option pack. Exp. = Expression.
 6 = Not available on 1.4i 16v VVT (100PS) or 1.3CDTi 16v models. 8 = Not available on 1.3CDTi 16v models. 9 = Not available on 1.4i 16v VVT (87PS and 100PS) or 1.3CDTi 16v models. 10 = Only available in conjunction with Sight and Light Pack. 11 = Not available in conjunction with ergonomic sports front seats. 12 = Not available on 1.4i 16v VVT (87PS) models. 13 = Shark fin/integrated aerial is also included. 14 = Not available in conjunction with CD 500 audio unit.

Audio, communication and navigation

Features	Exp.	ES	Exclusiv	SRi	SRi VX-Line	SE	Elite
CD player with MP3 format/stereo radio (CD 400) • CD player with MP3 format • AM/FM stereo radio with 36 station presets • Auxiliary-in socket • RDS with Traffic Programme • Graphic display • 20 watts per channel output • 7 speakers • Roof mounted flexible aerial	●	●	●	●	●	●	●
CD autochanger with MP3 format/stereo radio (CDC 400) • Integral six-disc CD autochanger with MP3 format • AM/FM stereo radio with 36 station presets • Auxiliary-in socket • Graphic display • RDS with Traffic Programme • 20 watts per channel output • 7 speakers • Roof mounted flexible aerial			○	○	○	○	○
Satellite navigation/CD player with MP3 format/stereo radio (CD 500) • Satellite navigation system • CD player with MP3 format • USB connection with iPod™ control • Auxiliary-in socket • AM/FM stereo radio with 36 station presets • RDS with Traffic Programme • Remote colour monitor • 20 watts per channel output • 7 speakers • Shark fin/integrated aerial			○	○	○	○	○
Infinity® Premium Sound System • 7 x 45 watt amplifier (315 watt total) • Digital Sound Processor (DSP) • One front mounted 3.5-inch medium range speaker • Two A-pillar mounted 1-inch tweeters • Two front door mounted 6.5-inch subwoofers • Two rear door mounted 6.5-inch wide-band speakers • One 8-inch subwoofer box in luggage compartment						○ ⁸	○
Digital Audio Broadcast (DAB) stereo receiver with shark fin/integrated aerial		○	○	○	○	○	○
Mobile phone system with Bluetooth® (does not include phone)		○	○	○	○	○	○
Embedded mobile phone system with Bluetooth® (does not include phone) ¹³			○	○	○	○	○
USB connection with iPod™ control ¹⁴		○	○	○	○	○	○
Steering wheel mounted audio controls			●	●	●	●	●

Auxiliary-in socket

The auxiliary-in socket allows you to connect your portable MP3 music player directly into the car's audio system. All you need is your music player and a suitable connecting lead to listen through your car's speaker system. When using an MP3 player in the car the majority of the controls, such as track selection, remain solely on the player, while only the volume is controlled via the car's regular audio controls.

USB connection

Fitted in conjunction with the optional CD 500 satellite navigation system, or available as an extra-cost option. It provides iPod™ control and read-out of iPod™ functions through the audio system display and charges the iPod™ whilst connected.

DAB facility

Digital audio broadcasts offer the user a variety of advantages over traditional FM, starting with improved sound quality. You'll often find a broader range of stations, many of which are not available on FM – you simply select the station, by name, from the displayed list. Some stations will even display the artists' names and song titles on the car's graphic display, while they're played.



Steering wheel mounted audio controls.



Shark fin aerial.



USB connection and auxiliary-in socket.

Petrol engines

	1.4i 16v VVT (87PS) ECOTEC-4	1.4i 16v VVT (100PS) ECOTEC-4	1.6i 16v VVT ECOTEC-4	1.4i 16v VVT Turbo ECOTEC-4	1.6i 16v Turbo ECOTEC-4
Capacity	1398cc	1398cc	1598cc	1364cc	1598cc
Maximum power	87PS (64kW) @ 6000rpm	100PS (74kW) @ 6000rpm	115PS (85kW) @ 6000rpm	140PS (103kW) @ 4900-6000rpm	180PS (132kW) @ 5500rpm
Maximum torque	130Nm (96 lb.ft.) @ 4000rpm	130Nm (96 lb.ft.) @ 4000rpm	155Nm (114 lb.ft.) @ 4000rpm	200Nm (147 lb.ft.) @ 1850-4900rpm	230Nm (169 lb.ft.) @ 2200-5400rpm
Configuration	4 cylinders, 4 valves per cylinder, double overhead camshafts				
Fuel/induction system	Naturally aspirated Variable Valve Timing (VVT). Multi-point sequential fuel injection.	Naturally aspirated Variable Valve Timing (VVT). Multi-point sequential fuel injection.	Naturally aspirated. Variable Valve Timing (VVT). Multi-point sequential fuel injection.	Water-cooled turbocharger with intercooler. Variable Valve Timing (VVT). Multi-point sequential fuel injection.	Water-cooled turbocharger with intercooler. Multi-point sequential fuel injection.
Emission compliance	Euro 5				
Service interval	20,000 miles or 1 year (whichever occurs sooner)				
Benefit in kind company car taxation rates – 2010/11 tax year					
Manual	15%	15%	18%	16%	20%*
Automatic	-	-	22%	-	-

Diesel engines

	1.3CDTi 16v ECOTEC-4 Turbo diesel with DPF	1.7CDTi 16v (110PS) ECOTEC-4 Turbo diesel with DPF	1.7CDTi 16v (125PS) ECOTEC-4 Turbo diesel with DPF	2.0CDTi 16v ECOTEC-4 Turbo diesel with DPF
Capacity	1248cc	1686cc	1686cc	1956cc
Maximum power	95PS (70kW) @ 4000rpm	110PS (81kW) @ 3800rpm	125PS (92kW) @ 4000rpm	160PS (118kW) @ 4000rpm
Maximum torque	190Nm (140 lb.ft.) @ 1750rpm	260Nm (192 lb.ft.) @ 1700-2500rpm	280Nm (206 lb.ft.) @ 2000-2700rpm	350Nm (258 lb.ft.) @ 1750-2500rpm
Configuration	4 cylinders, 4 valves per cylinder, double overhead camshafts			
Fuel/induction system	Variable geometry turbocharger with intercooler. Common rail fuel injection			
Emission compliance	Euro 5			
Service interval	20,000 miles or 1 year (whichever occurs sooner)			
Benefit in kind company car taxation rates – 2010/11 tax year				
Manual	13%	18% (13%*)	18% (13%*)	18%
Automatic	-	-	-	22%**

DPF = Diesel Particulate Filter.

* = Vehicles produced from w/c 12/04/10. Benefit in kind rate is 5% higher for models with 18-inch or 19-inch wheels.

** = Please note: benefit in kind rate is 1% higher for models fitted with 18-inch or 19-inch wheels.

Performance, fuel economy and emissions

	Wheel size (inches)	Performance (manufacturer's figures)			Fuel economy mpg (litres/100km)			CO ₂ emissions g/km
		Maximum speed (mph)	Acceleration (sec) 0-60mph	30-50mph (4th gear)	Urban driving	Extra-urban driving	Combined figure	
Manual								
1.4i 16v VVT (87PS)	16/17	105	14.0	tba	39.8 (7.1)	61.4 (4.6)	51.4 (5.5)	129
1.4i 16v VVT (100PS)	16/17	111	12.9	tba	39.8 (7.1)	61.4 (4.6)	51.4 (5.5)	129
1.6i 16v VVT	16/17/18	118	10.9	9.3	34.0 (8.3)	55.4 (5.1)	44.8 (6.3)	147
1.6i 16v VVT	19	118	10.9	9.3	33.6 (8.4)	54.3 (5.2)	44.1 (6.4)	149
1.4i 16v VVT Turbo	16/17/18	126	9.0	tba	35.8 (7.9)	60.1 (4.7)	47.9 (5.9)	138
1.4i 16v VVT Turbo	19	126	9.0	tba	35.3 (8.0)	60.1 (4.7)	47.9 (5.9)	139
1.6i 16v Turbo	16/17	138	7.9	6.2	32.1 (8.8)	50.4 (5.6)	41.5 (6.8)	159
1.6i 16v Turbo	18/19	138	7.9	6.2	31.7 (8.9)	50.4 (5.6)	41.5 (6.8)	160
1.3CDTi 16v ecoFLEX	16/17	109	13.8	tba	57.6 (4.9)	76.3 (3.7)	68.9 (4.1)	109
1.7CDTi 16v (110PS) [†]	16/17	113	11.8	tba	49.6 (5.7)	68.9 (4.1)	60.1 (4.7)	124
1.7CDTi 16v (110PS) [†]	18/19	113	11.8	tba	49.6 (5.7)	67.3 (4.2)	60.1 (4.7)	125
1.7CDTi 16v (125PS) [†]	16/17	122	10.7	6.3	49.6 (5.7)	68.9 (4.1)	60.1 (4.7)	124
1.7CDTi 16v (125PS) [†]	18/19	122	10.7	6.3	49.6 (5.7)	67.3 (4.2)	60.1 (4.7)	125
1.7CDTi 16v (110PS) ecoFLEX ^{††}	16/17	113	11.8	tba	52.3 (5.4)	70.6 (4.0)	62.8 (4.5)	119
1.7CDTi 16v (110PS) ^{††}	18/19	113	11.8	tba	51.4 (5.5)	68.9 (4.1)	61.4 (4.6)	122
1.7CDTi 16v (125PS) ecoFLEX ^{††}	16/17	122	10.7	6.3	52.3 (5.4)	70.6 (4.0)	62.8 (4.5)	119
1.7CDTi 16v (125PS) ^{††}	18/19	122	10.7	6.3	51.4 (5.5)	68.9 (4.1)	61.4 (4.6)	122
2.0CDTi 16v	16/17	134	8.5	5.5	45.6 (6.2)	72.4 (3.9)	58.9 (4.8)	126
2.0CDTi 16v	18/19	134	8.5	5.5	45.6 (6.2)	70.6 (4.0)	58.9 (4.8)	127
Automatic								
1.6i 16v VVT	16/17/18	114	12.5	-	28.8 (9.8)	50.4 (5.6)	39.8 (7.1)	167
1.6i 16v VVT	19	114	12.5	-	28.5 (9.9)	49.6 (5.7)	39.2 (7.2)	169
2.0CDTi 16v	16/17	131	8.6	-	35.8 (7.9)	61.4 (4.6)	48.7 (5.8)	154
2.0CDTi 16v	18/19	131	8.6	-	35.8 (7.9)	60.1 (4.7)	47.9 (5.9)	155

tba = To be advised. † = Figures apply to vehicles produced prior to w/c 12/04/10. †† = Figures apply to vehicles produced from w/c 12/04/10.

All information was accurate and up-to-date at the time of going to press. The company reserves the right to alter engine specifications at any time, which may influence the content of the shown data. Please consult your Vauxhall retailer for the latest information. All figures quoted relate to the EU base model with standard equipment. Fuel consumption data and CO₂ emission data determined according to regulation EC 715/2007 and regulation EC 692/2008, taking into consideration the vehicle weight in running order, as specified by the regulation. Additional equipment may lead to slightly higher results than the stated consumption and CO₂ figures. In addition, it may increase the weight of the vehicle when empty and in some cases the permissible axle weights as well as the permissible total weight of the vehicle and reduce the permissible towing weights. This may lead to a reduction in top speed and increased acceleration time. The driving performance figures shown are attainable when the vehicle is empty, plus a load of 200 kilograms.

Vauxhall supporting



Smarter driving tips

- **Drive at an appropriate speed:** Staying within the speed limit increases driver safety, reduces CO₂ emissions and saves fuel. At 70mph you could be using up to 9% more fuel than at 60mph and up to 15% more fuel than at 50mph
- **Drive smoothly at all times:** Anticipate the ebb and flow of the traffic to avoid harsh acceleration and braking
- **Reduce your revs:** Change gear earlier to help reduce fuel consumption – try 2500rpm with petrol engines and 2000rpm with diesel
- **Idling is wasting fuel:** If you're likely to be at a standstill for more than three minutes, switch off the engine to save fuel
- **Regularly check your tyre pressures:** Under inflated tyres increase CO₂ emissions whilst incorrectly inflated tyres can be unsafe. Always check your handbook for the correct tyre pressure. This will also help to increase the life of your tyres
- **Remove unnecessary items from the car:** Extra weight increases the engine's workload, whilst roof racks and bike carriers increase wind resistance. All burn more fuel and increase CO₂ emissions



MacPherson strut front suspension.



Compound crank rear suspension includes innovative use of Watt's link



Watt's link improves handling and ride comfort.

Vauxhall Assistance and warranties*

- All new Vauxhalls qualify for a three-year vehicle warranty consisting of a one year/ unlimited mileage manufacturer's warranty and a second and third year manufacturer's warranty with a 60,000 miles limitation
- Vauxhall Assistance for 12 months from first registration
- Six years' body panel anti-perforation warranty

* = Warranty is only available on vehicles sourced from General Motors UK Limited. Terms and conditions apply - please see your Vauxhall retailer for details.

Optional transmission Six-speed automatic transmission with Active Select function

An all-new six-speed automatic transmission is optional on 1.6i 16v VVT and 2.0CDTi 16v models. On the road, a wide selection of shift patterns is adapted to the style and habits of the driver, anticipating when maximum acceleration or maximum efficiency is required. The electronic control will also adapt to the prevailing road conditions, reducing gear shifting when climbing or descending and using engine braking assistance during down changes. The ActiveSelect® manual mode allows the gear lever to be used like a sequential manual gearbox - you simply push the lever forward or back to change up or down the gears. The driver also benefits from a 'neutral' gear disengagement at idle, which reduces vibration and contributes to improved fuel consumption.

Suspension

Front: Independent. Lightweight MacPherson struts with gas-pressure dampers and coil springs. Anti-roll bar.
Rear: Lightweight compound crank rear axle with one-piece, hollow cast trailing arms. Built-in anti-roll bar. Progressive-rate double conical mini-block springs with Watt's link and gas-pressure dampers.

Steering

- Power-assisted steering
- Turning circle (kerb-to-kerb): - 11.0m (36.1ft)

Brakes

- Anti-lock Braking System (ABS)
- Electronic Brakeforce Distribution
- Hydraulic Brake Fade Assist
- Cornering Brake Control
- Emergency Brake Assist
- Electric parking brake with Hill Start Assist (HSA) (standard on SRI/SRI VX-Line/SE/ Elite models)

1.4i 16v VVT (87/100PS)

Front ventilated discs: 276mm diameter
Rear discs: 268mm diameter

1.6i 16v VVT

Front ventilated discs: 276mm diameter
Rear discs: 268mm diameter

1.4i 16v VVT Turbo

Front ventilated discs: 276mm diameter
Rear discs: 268mm diameter

1.6i 16v Turbo

Front ventilated discs: 300mm diameter
Rear discs: 292mm diameter

1.3CDTi 16v

Front ventilated discs: 276mm diameter
Rear discs: 268mm diameter

1.7CDTi 16v (110/125PS)

Front ventilated discs: 300mm diameter
Rear discs: 292mm diameter

2.0CDTi 16v

Front ventilated discs: 300mm diameter
Rear discs: 292mm diameter

Body

Aerodynamic drag co-efficient: - Cd 0.31

Fuel tank capacity

56 litres (12.3 gallons).

Wheels and tyres

- For wheel styles please see page 42.
- All models feature a steel space-saver spare wheel with 16-inch tyre.

16-inch wheels

All petrol/1.3CDTi 16v engines:

205/60 R 16

1.7CDTi 16v engines:

215/60 R 16

17-inch wheels

1.4i 16v VVT/1.6i 16v VVT/

1.4i 16v VVT Turbo/1.3CDTi 16v engines:

215/50 R 17

1.6i 16v Turbo/1.7CDTi 16v/

2.0CDTi 16v engines:

225/50 R 17

18-inch wheels

1.6i 16v VVT/1.4i 16v VVT Turbo engines:

225/45 R 18

1.6i 16v Turbo/1.7CDTi 16v/

2.0CDTi 16v engines:

235/45 R 18

19-inch wheels

All engines: 235/40 R 19

Exterior dimensions millimetres (inches)

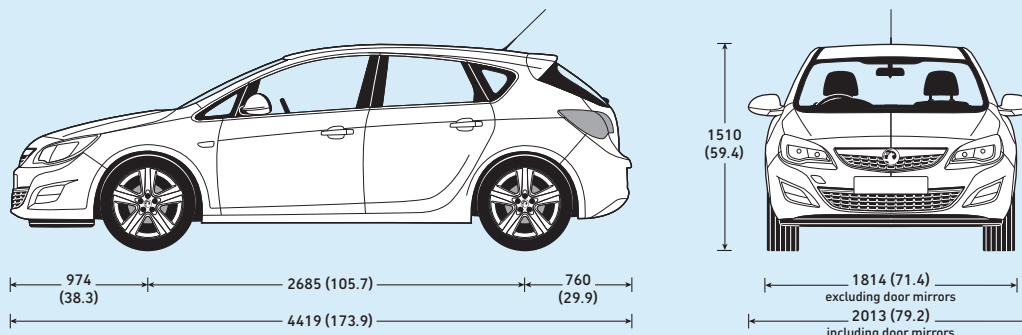

Weights and towing data kg

	Gross vehicle weight	Maximum towing weights Trailer with brakes (without brakes)
1.4i 16v VVT (87PS)	1885	850 (670)
1.4i 16v VVT (100PS)	1885	850 (670)
1.6i 16v VVT	1905	1250 (680)
1.6i 16v VVT (automatic)	1940	1250 (680)
1.4i 16v VVT Turbo	1940	1400 (680) [†]
1.6i 16v Turbo	1965	1500 (730)
1.3CDTi 16v	1885	1000 (680)
1.7CDTi 16v (110PS)	2020	1400 (730)
1.7CDTi 16v (125PS)	2020	1500 (730)
2.0CDTi 16v	2040	1500 (730)
2.0CDTi 16v (automatic)	2065	1500 (730)

[†] = Provisional data

Gross vehicle weight is the total permissible weight of the vehicle including passengers and their luggage. The **maximum roof rack loading** should not exceed 75kg. The **maximum towing weights** are based on the ability of the car, with two occupants of 75kg each, to restart on a 12% gradient, which is approximately 1 in 8.3 at sea level. At altitudes above 1500 metres, the engine output may drop with a corresponding reduction in towing capability. Any extra weight, such as luggage or additional passengers, should be deducted from the maximum towing weight. With a trailer fully loaded, **maximum noseweight** should not exceed 75kg. Always fit Vauxhall towing attachments and accessories available from your Vauxhall retailer. They are designed specifically for Vauxhall models and carry a 12-month guarantee.

Luggage capacities (ECIE method)

	litres	cu.ft.
Rear seat up*	351	12.3
Rear seat down**	776	27.4
Rear seat down (to roof)	1216	42.9

* = Flex Floor in lowest position.

** = To upper edge of front seat.

Please note fitment of Infinity[®] Sound System reduces load volume by 38 litres.



Flex Floor – adjustable luggage compartment floor.

Features explained

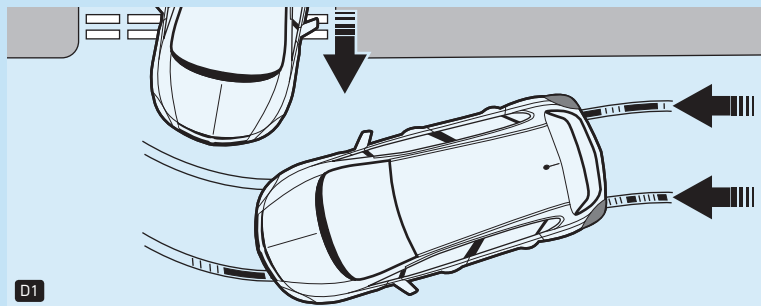

Anti-lock Braking System (ABS) with Cornering Brake Control (CBC)
D1. Cornering brake control makes the car easier to control in extreme situations, particularly when braking sharply on a bend. It is particularly effective when carrying out emergency procedures, such as avoiding a child's ball that's rolled out from the kerb. The system works by sensing the different rotational speeds of the individual road wheels and co-ordinating the level of braking pressure applied to each wheel. CBC is an integral part of new Astra's comprehensive ABS.

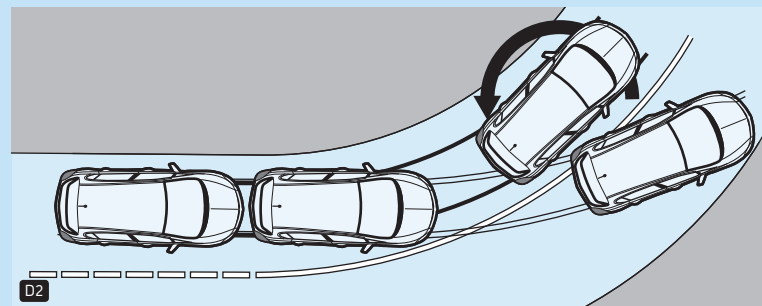

Electronic Stability Programme-plus (ESP-plus)
D2. ESP-plus provides enhanced yaw compensation during understeer or oversteer. It works by monitoring the front and rear of the car and comparing their respective directions of travel with the input through the steering wheel. If the vehicle starts to slide, ESP-plus applies corrective braking to the appropriate wheel, or wheels, compensating for the slide and helping you regain control more rapidly. ESP-plus offers additional safety in the form of two-way traction control, which helps prevent the driving wheels from spinning, under acceleration, on slippery surfaces.

Sight and Light Pack – consisting of:

Automatic lighting control

When the main lighting control is set to 'Auto' new Astra's headlights switch on automatically when you enter a tunnel or when darkness descends.

Rain-sensitive windscreen wipers

Activated by a sensor mounted in the rear-view mirror housing, the windscreen wipers switch on automatically when they sense rain on the screen and adjust their wiping speed to suit the prevailing conditions.



Electro-chromatic anti-dazzle rear-view mirror

D3. At night, sensors integrated within the internal rear-view mirror detect following headlights and adjust the brilliance of the reflection to remove glare. To assist parking, the mirror automatically returns to full reflectivity when reverse gear is selected.

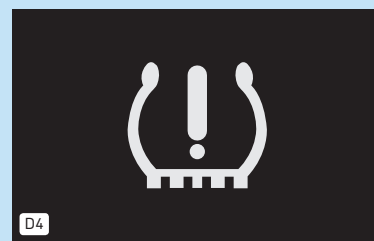

Tyre Pressure Monitoring System (TPMS)
D4. Optional at extra cost on all models except S, TPMS monitors the tyre pressure via sensors on the inner sides of the valves and activates a warning display if there is a loss of pressure.

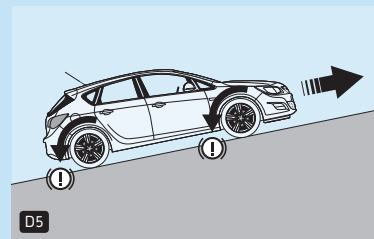

Hill Start Assist (HSA)
D5. Hill Start Assist maintains the brake pressure for a short period after the brake pedal has been released when pulling away on a gradient of 5% or more; this helps prevent the vehicle from rolling back. The pressure is released as soon as the driver presses the accelerator and the car begins to move forward.



D6

FlexRide chassis with Drive Mode Control (DMC)

D6. An integrated, fully adaptive chassis control system that significantly enhances the ride and handling performance – and safety – of new Astra. The electronic brain behind FlexRide is the Drive Mode Control (DMC) module. Utilising sophisticated vehicle dynamics information, DMC constantly monitors up to 11 different driving dynamic variables – including acceleration, braking and cornering – and optimises the behaviour of the chassis accordingly. DMC also analyses the chosen FlexRide drive mode selected by the driver. Another key function is the monitoring of driving style. DMC recognises if the driver is driving normally or sportily and adapts chassis performance to match. In addition, FlexRide offers important safety benefits in emergency situations: for example, if an ‘unusual’ manoeuvre is detected the dampers are stiffened by one level (i.e. from Normal to Sport mode) within milliseconds.

Continuous Damping Control (CDC)

D7. The heart of the FlexRide system is its Continuous Damping Control (CDC) technology – this uses a series of electronic sensors to constantly monitor and control the suspension for optimum stability, driver engagement and comfort. In simple terms, CDC, the four-channel Anti-lock Braking System (with Electronic Brakeforce Distribution), traction control and Electronic Stability Programme-plus (ESP-plus) all communicate with each other, continuously, to optimum effect. The process occurs 100 times per second, equivalent to intervals of around 12 inches at a speed of 62mph. Based on this information, the adaptive damping system continually optimises body control by changing the damping force in real

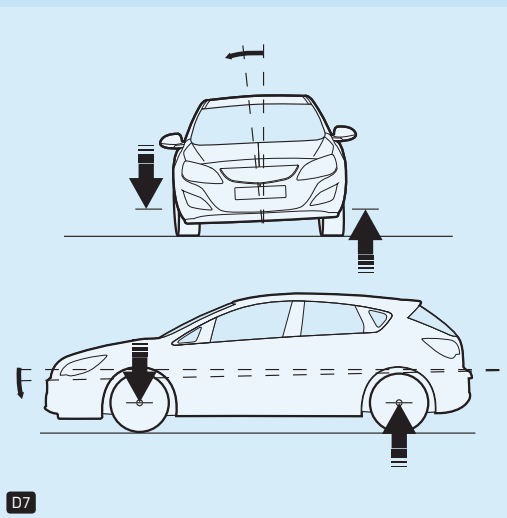

D7

time. For example, when braking the dampers are adjusted accordingly, avoiding excessive body pitch and promoting more comfortable braking behaviour. Fast steering manoeuvres are detected via changes to the steering angle, and here the damping is changed to a firmer setting, reducing body roll, giving a safer, smoother, more comfortable drive.

Sport mode

Select Sport mode and FlexRide not only provides stiffer damping, but also swifter throttle response for more dynamic driving. It also sharpens the speed-sensitive steering and raises the shift-points of the automatic transmission to a higher rpm. A customisation menu, accessible via the facia display, allows the driver to personalise the Sport mode by specifying which functions are activated when the Sport button is pushed. For instance, the electronically controlled dampers and steering can be added or switched off. The instrument lighting switches from white to red adding to the driving experience.

Tour mode

Ideal for long motorway journeys, the Tour mode adjusts the dampers to a softer setting to create a perceptibly smoother ride and further enhance new Astra's ride comfort.

Normal mode

In Normal mode. The dampers permanently adapt to changing driving conditions, providing more comfort than a conventional chassis but with improved cornering behaviour and better steering response in quickly changing traffic situations.

Trust Vauxhall

Protecting the environment

Vauxhall's commitment to the environment is demonstrated by our products' many environmental awards, won both through the use of more recycled materials and by becoming cleaner and more efficient. For information on Vauxhall's efforts to achieve an environmentally sustainable future, see www.vauxhall.co.uk/recycling

Fleet Customer Services

Our dedicated support services for fleet managers includes factory demonstrators, a three-day test drive programme and information on whole life costs, company car taxation and finance. For further information please call **0870 010 0651**.

Buying your car

GMAC offers one of the most comprehensive and competitive ranges of financing plans in the UK. Contact your local Vauxhall retailer for details or call the GMAC customer service centre on **0845 712 3444**.

Vauxhall Extended Warranty

For complete peace of mind Vauxhall offers an extended warranty that can be purchased on an annual basis following the expiry of the original new car warranty. It covers most mechanical and electrical components. Terms and conditions apply, for further details please contact your local Vauxhall retailer.

Servicing and maintenance

The best way to maximise the performance and reliability of your Vauxhall is to have all routine servicing and maintenance carried out at one of around 400 Vauxhall retailers. To find your nearest retailer call **0845 600 1500**.

In the event of an accident...

Vauxhall Accident Support helps keep you mobile following an accident. Benefits include scene-of-accident advice, message service, assistance with claims and vehicle recovery. For further details call **0800 010 304**.

Vauxhall Insurance

Available for new and used Vauxhalls, a Vauxhall Insurance policy offers a unique package designed specifically for Vauxhall drivers. For a highly competitive quotation, call **0844 84 85 840** (Great Britain) or **0845 35 13 410** (N. Ireland). Or just visit our website at www.vauxhall.co.uk

For more information...

For a brochure on any Vauxhall model (up to a maximum of three per caller) or location of your nearest Vauxhall retailer please **Lo-call 0845 600 1500**.

Alternatively, details can be found on our website at www.vauxhall.co.uk



When you have finished with this brochure please recycle it

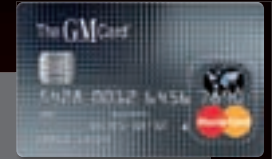

- Save up to **£1500*** on a new Vauxhall with The GM Card
- 100 Rebate Points worth **£100** when you use The GM Card for the first time
- Rebate Point saving is on top of any discount or offer negotiated with the Retailer
- Earn 3 Rebate Points (€3) for every **£100** you spend

Typical 14.9% APR variable

To apply call **0845 746 2777** or visit www.gmcard.co.uk

The GM Card is issued by HFC Bank Limited and is available to persons aged 18 years or over and resident in the UK (or 21 and over in the Channel Islands) and is subject to status and conditions. Written quotations are available upon request from The GM Card, PO Box 3615, Birmingham B3 2RJ. The typical APR quoted is the rate for new customers. Rebate Points are earned on purchases using The GM Card. Rebate Points are not earned on Balance Transfers or Cash Advances. You earn money off a new Vauxhall by accumulating Rebate Points under the Rebate Points Programme. General Motors UK Limited is solely responsible for the operation of the Rebate Points Programme, which is subject to the Rebate Points Programme Rules. *You can redeem up to 1500 Rebate Points subject to the Model Line Maximum which will vary in amount in relation to different Vauxhall vehicle model lines and unlimited Partner Points. Rebate Points and unlimited Partner Points are redeemable as discounts on a new Vauxhall vehicle and must be redeemed four years from the issue date. Rebate Points may not be redeemed by Motability Contract Hire customers. 'The GM Card' is a trading name of both HFC Bank Limited and General Motors UK Limited. HFC Bank registered in England No. 1117305. Registered Office: North Street, Winkfield, Windsor, Berkshire SL4 4TD is authorised and regulated by the Financial Services Authority. Member HSBC Group. HFC Bank Limited is not a member of the same group of companies as General Motors UK Limited or GMAC UK plc. General Motors UK Limited, Registered Office: Griffin House, Osborne Road, Luton, Bedfordshire LU1 3YT. Registered in England number 135767. - CN6/0987.

Every effort has been made to ensure that the contents of this publication were accurate and up-to-date at the time of going to press (March 2010). Vauxhall vehicles are equipped with components manufactured by various General Motors operating units and outside suppliers. The Company reserves the right to alter specifications and withdraw products from sale without notice. Any such alterations will be notified to Vauxhall retailers at the earliest opportunity; please consult your local retailer for the latest information. The specifications detailed within this brochure are not necessarily applicable to alternative models such as Special Editions. Details of any such models will be contained in specific literature or found on the Vauxhall website. Please note that Vauxhall retailers are not the agents of General Motors UK Limited and are not authorised to bind the Company by any specific or implied undertaking or representation. It is advisable to ensure that your motor insurance policy provides adequate cover for additional fitted options and accessories. Please note accessories shown are for illustrative purposes only. As part of Vauxhall's policy of environmental care, this brochure is printed on paper manufactured using Elemental Chlorine Free pulps from specially farmed, sustainable timber resources. All rights reserved. No part of this publication may be reproduced in any form or by any means, without the prior written permission of General Motors UK Limited.

